

English

American Dg[®]

SCENE SETTER-48

48CH Dimmer Console

USER'S MANUAL

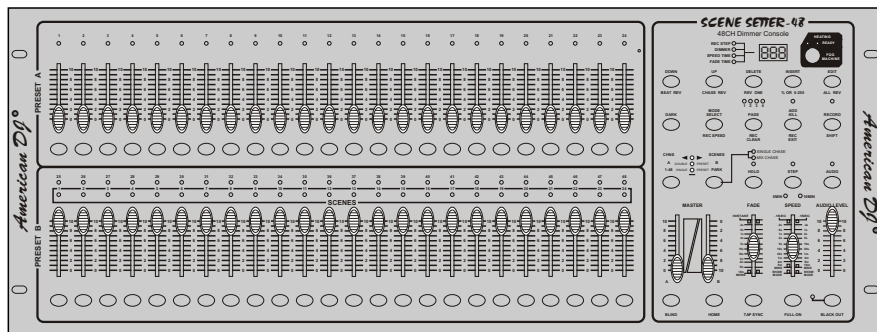

Please read before use

American DJ®

SCENE SETTER-48

48CH Dimmer Console

Improvement and changes to specifications, design and this manual, may be may at any time without prior notice.

All rights reserved.

Contents

Features 1

General Instructions 2

1. Overview 3

1.1 Front View 3

1.2 Rear View 6

2. Operation Guide 7

2.1 Begin Programming 7

2.1.1 Record Enable 7

2.1.2 Security for Your Programs 7

2.1.3 Program Scenes 8

2.2 Editing 11

2.2.1 Edit Enable 11

2.2.2 Erase a Program 12

2.2.3 Erase all Programs 13

2.2.4 Clear a Scene or Scenes 13

2.2.5 Delete a Step or Steps 14

2.2.6 Insert a Step or Steps 15

2.2.7 Modify a Step or Steps 17

2.3 Running 18

2.3.1 Running Chase Programs 18

2.3.2 Running a Program To Audio 19

2.3.3 Running a Program With the
Speed Slider 20

2.3.4 Running a Program With the
Standard Beat 21

2.4 Change the Speed Mode between 5 Minutes and 10 Minutes 22

3. MIDI Operation 23

3.1 Setting MIDI IN 23

3.2 Setting MIDI OUT 23

3.3 Exit MIDI Setting 24

3.4 Receiving MIDI File Dump 24

3.5 Sending MIDI File Dump 25

3.6 Implementation 25

Brief of Main Functions 27

Technical Specifications 30

Features

Thank you for your purchase. This product features include:

■ **Digital Technology Adopted.**

As a stage light controller, the unit can control intelligent unit and ordinary light.

■ **Power Failure Memory.**

Automatically recover to the last condition when you turn on the machine.

■ **Standard MIDI and DMX ports.**

Conveniently connect with other units and machines.

■ **Powerful Program Edit.**

You could edit different program according to your needs. The program could contain 4600 steps utmost and up to 96 programs could be stored.

■ **Various Running Type.**

You can run the SCENE with Audio, Speed Slider, Standard beat etc.

■ **More programs can run synchronously.**

You can run more programs in Single Mode or Mix Mode simultaneously

General Instructions

Read the instruction in this manual carefully and thoroughly, as they give important information regarding safety during use and maintenance. Keep this manual with the unit, in order to consult it in the future. If the unit is sold or given to another operator, make certain that it always has its manual, to enable the new owner to read about its operation and relative instructions.



Warnings

- **DO NOT** make any inflammable liquids, water or metal objects enter the unit.
- Should any liquid be spilled on the unit, **DISCONNECT** the power supply to the unit immediately.
- **STOP** using the unit immediately in the event of serious operation problems and either contact your local dealer for a check or contact us directly.
- **DO NOT** open the unit--there are no user serviceable parts inside.
- **NEVER** try to repair the unit yourself. Repairs by unqualified people could cause damage or faulty operation. Contact your nearest dealer.



Cautions

- This unit is **NOT** intended for home use.
- After having removed the packaging check that the unit is **NOT** damaged in any way. If in doubt, **DON'T** use it and contact an authorized dealer.
- Packaging material (plastic bags, polystyrene foam, nails, etc.) **MUST NOT** be left within children's reach, as it can be dangerous.
- This unit must only be operated by adults. **DO NOT** allow children to tamper or play with it.
- **NEVER** use the unit under the following conditions:
 - In places subject to excessive humidity.
 - In places subject to vibrations or bumps.
 - In places with a temperature of over 45°C/113°F or less than 2°C/35.6°F.Protect the unit from excessive dryness or humidity (ideal conditions are between 35% and 80%).
- **DO NOT** dismantle or modify the unit.

1. Overview

1.1 Front View

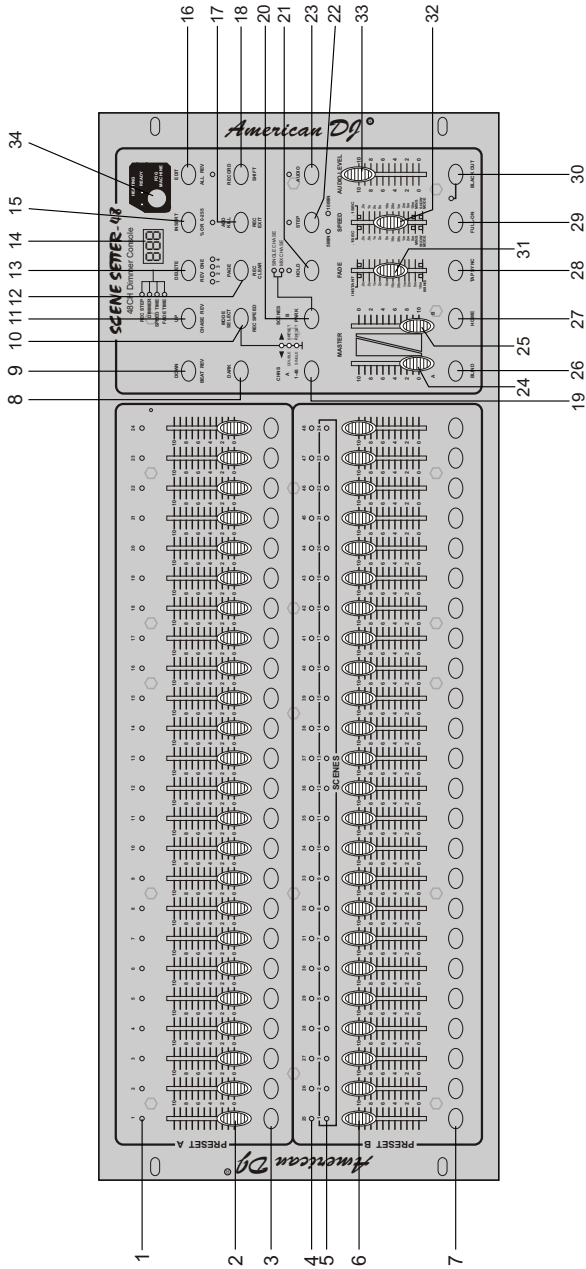

1. Overview

1.1 Front View

- | | |
|---------------------------|---|
| 1. Preset A LEDs | Show the current intensity of the relevant channel numbered from 1 to 24. |
| 2. Channel Sliders 1-24 | These 24 sliders are used to control and /or program the intensities of channels 1-24. |
| 3. Flash Buttons 1-24 | These 24 buttons are used to bring an individual channel, to full intensity. |
| 4. Preset B LEDs | Show the current intensity of the relevant channel numbered from 25-48. |
| 5. SCENE LEDs | Light when relevant scenes are active. |
| 6. Channel Sliders 25-48 | These 24 sliders are used to control and /or program the intensities of channels 25-48. |
| 7. Flash Buttons 25-48 | These 24 buttons are used to bring an individual channel, to full intensity. They also are used for programming. |
| 8. Dark Button | This button is used to momentarily black out overall output. |
| 9. Down/Beat Rev | DOWN functions to modify a scene in Edit mode; BEAT REV is used to reverse the chasing direction of a program with regular beat. |
| 10. Mode Select/Rec Speed | Each tap will activate the operating mode in the order: CHNS /SCENES, Double Preset and Single Preset. Rec Speed: Set the speed of any of the programs chasing in Mix mode. |
| 11. Up/Chase Rev | Up is used to modify a scene in Edit mode. Chase Rev is to reverse the chasing direction of a scene under Speed Slider control. |
| 12. Page Button | Tap to select pages of scenes from Page 1-4. |
| 13. Delete/ Rev One | Delete any step of a scene or reverse the chasing direction of any program. |
| 14. Segment Display | Shows the current activity or programming state. |
| 15. Insert / % or 0-255 | Insert is to add one step or steps into a scene. % or 0-255 is used to change display value cycle between % and 0-255. |

1. Overview

1.1 Front View

- | | |
|---------------------------|---|
| 16. Edit / All Rev | Edit is used to activate Edit mode.
All Rev is to reverse the chasing direction of all programs. |
| 17. Add or Kill/ Rec Exit | In Add mode, multiple scenes or Flash buttons will be on at a time.
In Kill mode, pressing any Flash button will kill any other scenes or programs.
Rec Exit is used to exit from Program or Edit mode. |
| 18. Record/ Shift | Record is used to activate Record mode or program a step.
Shift functions only used with other buttons. |
| 19. Master A Button | Brings channel 1-12 to full of current setting. |
| 20. Park Button | Used to select Single/Mix Chase, bring Channel 13-24 to full of current setting, or momentarily program a scene into Master B slider, depending on the current mode. |
| 21. Hold Button | This button is used to maintain current scene. |
| 22. Step Button | This button is used to go to next step when the Speed Slider is pushed to the bottom or in Edit mode. |
| 23. Audio Button | Activates audio sync of chase and audio intensity effects. |
| 24. Master Slider A | This slider controls overall output of all channels. |
| 25. Master Slider B | This slider controls the chase of all programs. |
| 26. Blind Button | This function takes the channel out of the chase of a program in CHNS /SCENE mode. |
| 27. Home Button | This button is used to deactivate the Blind. |
| 28. Tap Sync Button | Repeatedly tapping this button establish the chase speed. |
| 29. Full On Button | This function bring overall output to full intensity. |
| 30. Black Out Button | This button is used to kill all output with exception for that resulting from Flash and Full On. |
| 31. Fade Time Slider | Used to adjust the Fade Time. |
| 32. Speed Slider | Used to adjust the chase speed. |
| 33. Audio Level Slider | This slider controls the sensitivity of the Audio input. |
| 34. Fog Machine button | |

1. Overview

1.2 Rear View

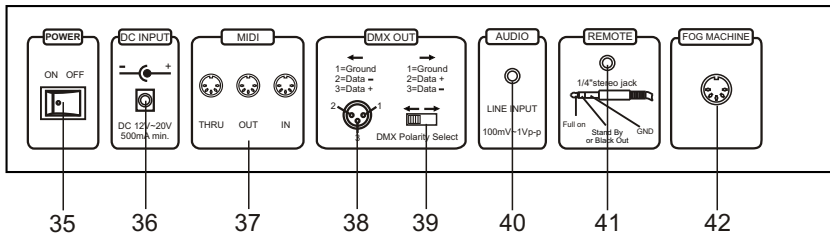

- | | |
|---------------------------|--|
| 35. Power Switch | This switch controls turning on or off of the power. |
| 36. DC Input | DC 12-20V, 500 mA Min. |
| 37. MIDI Thru/Out/In | MIDI ports for connection to a sequencer or MIDI device. |
| 38. DMX Out | This connector sends your DMX value to the DMX fixture or DMX pack. |
| 39. DMX Polarity Select | Used to select DMX polarity. |
| 40. Audio Input | This jack accepts a line level audio input signal ranged from 100mV to 1Vpp. |
| 41. Remote Input | Black Out and Full On may be controlled by a remote control using a standard 1/4" stereo jack. |
| 42. Fog Machine Connector | |

2. Operation Guide

2.1 Begin Programming

2.1.1 Record Enable

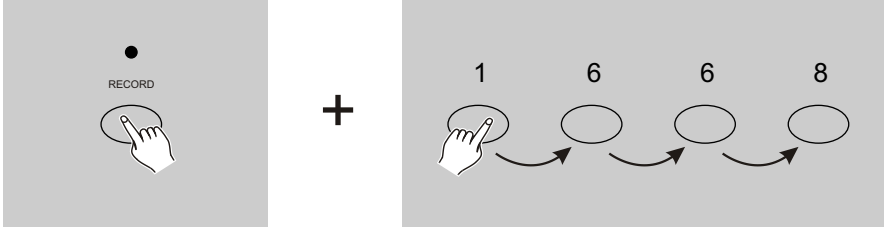

1. Press and hold down the Record button.
2. While holding down the Record button, tap the Flash buttons 1, 6, 6 and 8 in sequence.
3. Release the Record button, the Record LED lights up, now you can begin programming your chase patterns.

NOTE:

The first time you turn on your unit, the default setting of the Record Code is Flash buttons 1, 6, 6 and 8.

You may change the Record Code to protect your programs.

2.1.2 Security for Your Programs

To protect your programs from any editing by others, you may change the Record Code.

1. Enter current Record Code(Flash buttons 1, 6, 6 and 8).
2. Press and hold down the Record and Edit buttons at a time.

2. Operation Guide

2.1.2 Security for Your Programs

3. While holding the Record and Edit buttons, tap the desired Flash button to enter a new Record Code
The Record Code consists of 4 Flash buttons(the same button or different buttons), be sure your new Record Code consists of 4 Flash buttons.
4. Enter your new Record Code a second time, all channel LEDs and scene LEDs will flash three times, now the Record Code is changed.
5. Exit Record mode. Tap the Rec Exit button while pressing and holding down the Record button, release the two buttons at a time, the Record mode is disengaged.

IMPORTANT!!!

Always remember to exit Record mode when you won't continue your programming, otherwise you may lose control of your unit.

NOTE:

The second time you enter your new Record Code different from that of the first time, the LEDs will not flash, which means you've failed to change the Record Code.

When you've entered a new Record Code the first time, and now you want to cancel the new Record Code, you may press and hold down the Record and Exit buttons at a time to exit.

2.1.3 Program Scenes

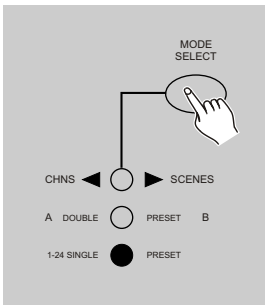

1. Record Enable.
2. Select the 1-48 Single mode by tapping the the Mode Select button. This will give you control of all 48 channels as you program.

Be sure that Master A & B are both set at maximum.
(Master A is at its maximum in the fully up position , while Master B is at its maximum in the fully down position.)

2. Operation Guide

2.1.3 Program Scenes

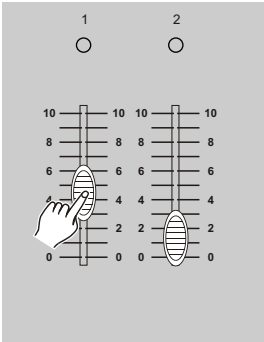

3. Create a desired scene using Channel Sliders 1-48. At 0% or DMX 0, these sliders should be at 0 position, and at 100% or DMX 255, these sliders should be at 10 position.

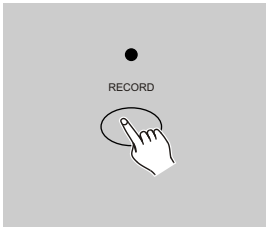

4. Once the scene is satisfactory, tap the Record button to program the scene as a step into the memory.

5. Repeat step 3 and step 4 until all desired steps have been programmed into memory.
You may program up to 1000 steps into memory.

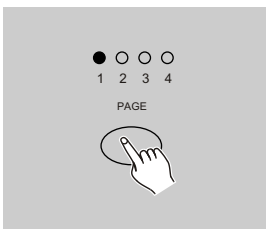

6. Select a chase bank or scene master to store your program. Tap the Page button to select a page(Page 1-4) to store your scenes.

2. Operation Guide

2.1.3 Program Scenes

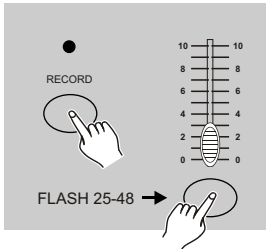

7. Press a Flash button between 25-48 while holding down the Record button. All LED will flash indicating the scenes have been programmed into memory.

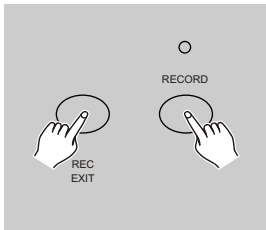

8. You can continue programming or exit.
To exit Program mode, tap the Exit button while holding down the Record button, the Record LED should go out.

EXAMPLE: Program a 16 steps chase with channel 1-32 at full in sequence into Flash button 25 of Page 1.

1. Record enable.
2. Push Master A & B to maximum position and Fade slider to top.
3. Tap the Mode Select button to select 1-48 Single mode.
4. Push Channel slider 1 to the top position, its LED light at full intensity.
5. Tap the Record button to program this step into memory.
6. Repeat steps 4 and 5 until you've programmed Channel sliders 1-32.
7. Tap the Page button causing Page 1 LED lights.
8. Tap the Flash button 25 while holding down the Record button, all LEDs will flash indicating you've programmed the chase into memory.

2. Operation Guide

2.2 Editing

2.2.1 Edit Enable

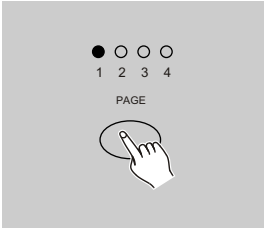

1. Record enable.
2. Use the Page button to select the page the program you wish to edit is on.

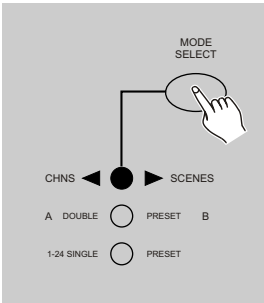

3. Tap the Mode Select button to select CHNS ◀▶ SCENES.

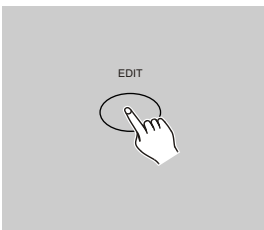

4. Press and hold down the Edit button.

2. Operation Guide

2.2.1 Edit Programs

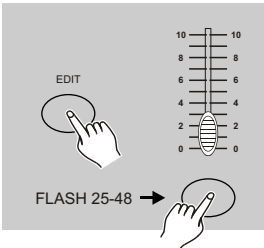

5. While holding down the Edit button, tap the Flash button that corresponds to the program you wish to edit.

6. Release the Edit button, the relevant scene LED should light indicating you are in the Edit mode.

2.2.2 Erase a Program

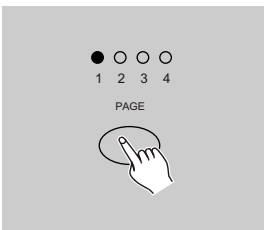

1. Record enable.

2. Use the Page button to select the page the program you wish to erase is on.

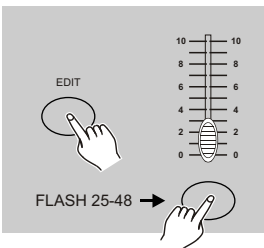

Tap this button twice

3. While holding down the Edit button, tap the Flash button(25-48) twice.

4. Release the two buttons ,all LEDs flash, indicating the program is erased.

2. Operation Guide

2.2 Editing

2.2.3 Erase All Programs

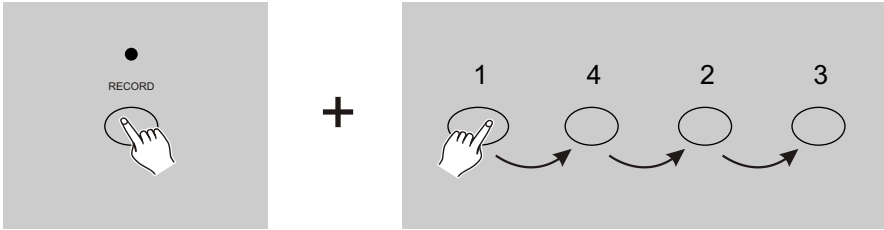

1. Press and hold the Record button.
2. Tap the Flash buttons 1, 4, 2 and 3 in sequence while holding the Record button. All LEDs will flash, indicating all programs stored in memory have been erased.

2.2.4 Clear a Scene or Scenes

1. Record enable.
2. Record a scene or scenes.
3. If you are not satisfied with the scene or scenes, you may tap the Rec Clear button while pressing and holding the Record button, all LEDs will flash, indicating the scenes have been cleared.

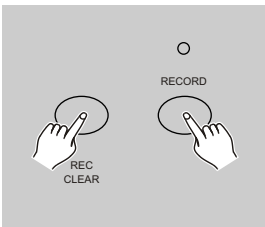

2. Operation Guide

2.2 Editing

2.2.5 Delete a Step or Steps

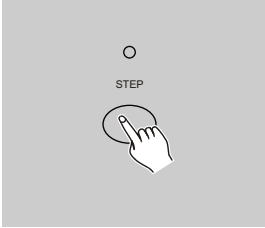

1. Enter the Edit mode.

2. Tap the Step button to scroll to the step you wish to delete.

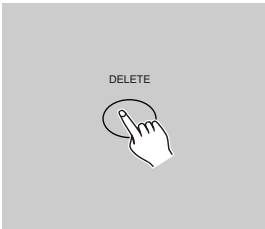

3. Tap the Delete button when you reach to the step you wish to delete, all LEDs will flash briefly indicating the deletion of the step.

4. Continue steps 2 and 3 until all the unwanted steps have been deleted.

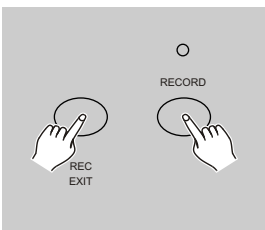

5. Tap the Rec Exit button while pressing and holding down the Record button, the Scene LED goes out, indicating the exit of Edit mode.

2. Operation Guide

2.2 Editing

2.2.5 Delete a Step or Steps

EXAMPLE: Delete the third step of the program on Flash button 25 on Page 2.

1. Record enable.
2. Tap the Mode Select button to select CHNS ◀▶ SCENE mode.
3. Tap the Page button until Page 2 LED lights.
4. Tap the Flash button 25 while pressing and holding down the Edit button, the Scene LED lights.
5. Tap the Step button to scroll to the third step.
6. Tap the Delete button to delete the step.
7. Tap the Rec Exit button while pressing and holding down the Record button to exit Edit mode.

2.2.6 Insert a Step or Steps



1. Record a scene or scenes you wish to insert.
2. Be sure you're in CHNS ◀▶ SCENE and Enter the Edit mode.
3. Tap the Step button to scroll to the step which you wish to insert before. You may read the step from the Segment Display.

2. Operation Guide

2.2.6 Insert a Step or Steps

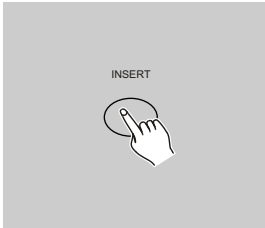

4. Tap the Insert button to insert the step you've created before, all LEDs will flash, indicating the step is inserted.

5. Exit Edit mode.

EXAMPLE: Insert a step with channels 1-12 fully on at a time between step 4 and step 5 of program 35.

1. Record enable.
2. Push Channel sliders 1-12 to the top and record the scene as a step.
3. Tap the Mode Select button to select CHNS ◀▶ SCENE mode.
4. Tap the Page button until Page 2 LED lights.
5. Tap the Flash button 35 while holding down the Edit button, the corresponding scene LED lights.
6. Tap the Step button to scroll to the step 4.
7. Tap the Insert button to insert the scene you've created before .

2. Operation Guide

2.2 Editing

2.2.7 Modify a Step or Steps



1. Enter Edit mode.

2. Tap the Step button to scroll to the step you wish to modify.

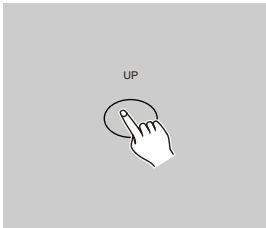

3. Press and hold the Up button if you want to raise the intensity.

If you want to lower the intensity, press and hold down the Down button.

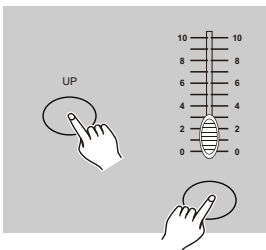

4. While holding down the Up or Down button, tap the Flash button corresponding to the DMX channel of the scene you wish to modify until you reach the desired intensity value read from the Segment Display. Then you may tap the Flash buttons until you are satisfied with the new scene.

5. Repeat steps 2, 3 and 4 until all the steps have been modified.

6. Exit Edit mode.

2. Operation Guide

2.3 Running

2.3.1 Running Chase Programs

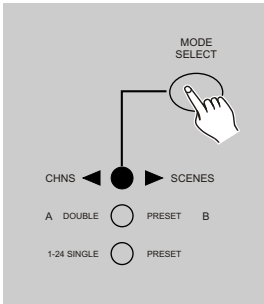

1. Tap the Mode Select button to select CHNS ◀ ▶ SCENE mode indicated by the red LED.

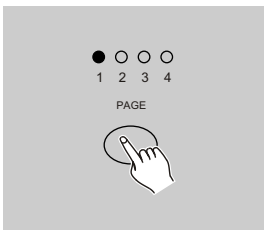

2. Tap the Page button to select the correct page the program you wish to run is located.

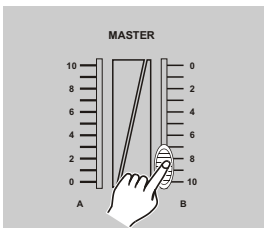

3. Push Master Slider B to its maximum position (fully down).

2. Operation Guide

2.3.1 Running Chase Programs

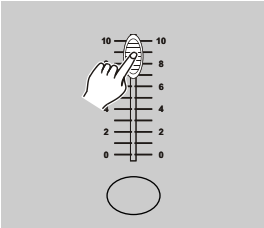

4. Move the desired Channel slider (25-48) to its maximum position to trigger the program, and the program will fade in depending upon current fade time.

You may press and hold down the relevant Flash button(25-48) to trigger the program.

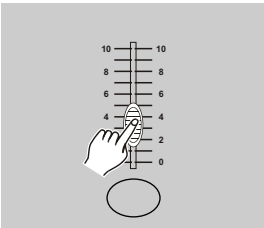

5. Move the Channel slider to adjust the output of the current program.

2.3.2 Running a Program To Audio

1. Use built-in microphone or plug the audio source into the RCA Audio jack.
2. Select your program as described above.
3. Tap the Audio button until its LED lights, indicating Audio mode is active.

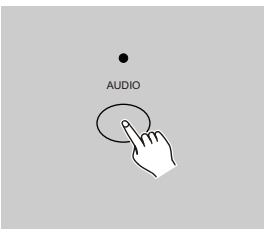

2. Operation Guide

2.3.2 Running a Program To Audio

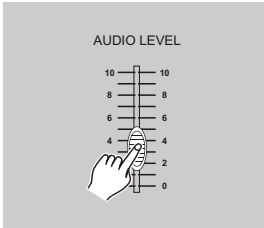

4. Use the Audio Level slider to adjust the music sensitivity.

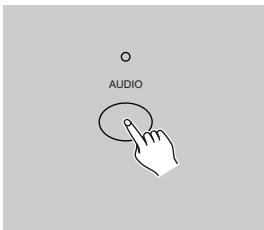

5. To return to normal mode, tap the Audio button a second time causing its LED goes out, the Audio mode is disengaged.

2.3.3 Running a Program With the Speed Slider

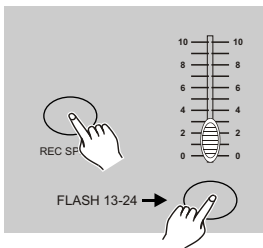

1. Be sure the Audio mode is disengaged, that is, the Audio LED goes out.
2. Select your program as described above.
3. Move the Speed slider to the SHOW MODE position (the bottom), then tap the Flash button (25-48) while pressing and holding down the Rec Speed button, the corresponding program will not run with the Standard beat any longer.

2. Operation Guide

2.3.3 Running a Program With the Speed Slider

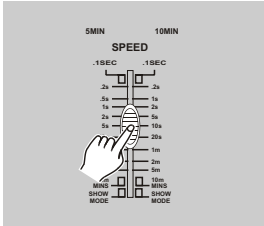

4. Now you may move the Speed Slider to select your desired speed.

NOTE:

The step 3 is not necessary if the selected program is not recorded with the Standard Beat.

2.3.4 Running a Program With the Standard Beat

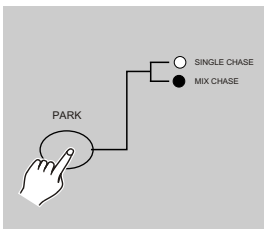

1. Be sure the Audio is disengaged. Tap the Mode Select button to select CHNS ◀▶ SCENE mode.

2. Tap the Park button to select Mix Chase mode, the LED lights indicating this selection.

3. Select your program as described above.

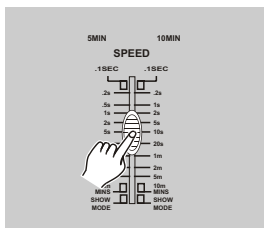

4. Move the Speed slider until the Segment Display reads your desired value.

You may tap the Tap Sync button twice to define your beat time.

2. Operation Guide

2.3.4 Running a Program With the Standard Beat

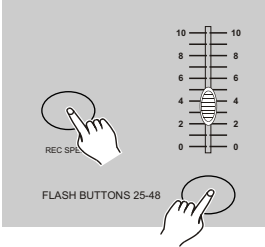

5. While pressing and holding down the Rec Speed button, tap the Flash button(25-48) that stores the program.
6. The program will then run with the set time or beat when engaged.
7. Repeat steps 4 and 5 to set a new beat time.

2.4 Change the Speed Mode between 5 Minutes and 10 Minutes

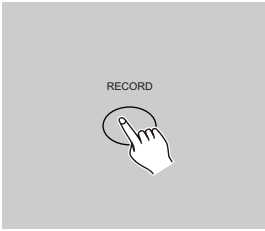

1. Press and hold the Record button.

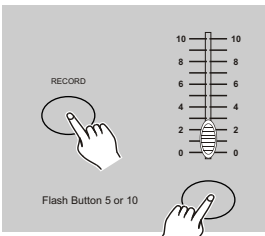

Tap this button three times

2. Tap the Flash button 5 or 10 three times while holding down the Record button.
3. The 5MIN or 10MIN should light up indicating the Speed slider is set to run in the 5 or 10 minute mode.

3. MIDI Operation

3.1 Setting MIDI IN

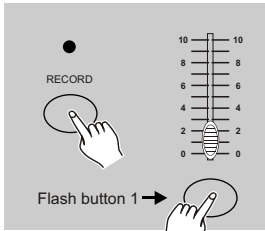

Tap this button three times

1. Tap the Flash button 1 three times while holding down the Record button, the Segment Display reads "CHI" indicating MIDI IN channel setup is available.

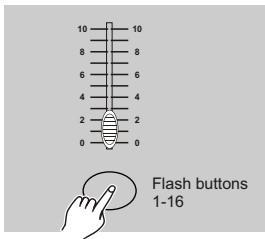

2. Tap the Flash button numbered from 1-16 to assign MIDI IN channel 1-16, the relevant channel LED lights indicating MIDI IN channel is set.

3.2 Setting MIDI OUT

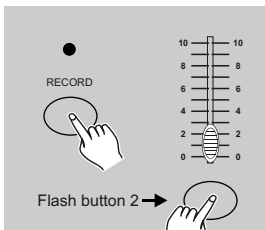

Tap this button three times

1. Tap the Flash button 2 three times while holding down the Record button, the Segment Display reads "CHO" indicating MIDI OUT channel setup is available.

3. MIDI Operation

3.2 Setting MIDI OUT

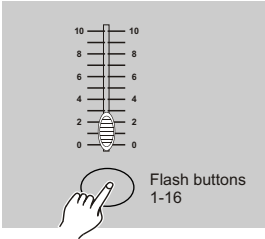

2. Tap the Flash button numbered from 1-16 to assign MIDI OUT channel 1-16, the relevant channel LED lights indicating MIDI OUT channel is set.

3.3 Exit MIDI Setting

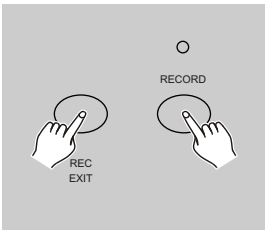

Press and hold down the Record button. While holding down the Record button tap the Rec Exit button to exit MIDI setting.

3.4 Receiving MIDI File Dump

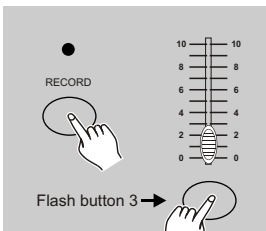

Tap this button three times

Tap the Flash button 3 three times while holding down the Record button, the Segment Display reads "IN" indicating the controller is ready to receive MIDI file dump.

3. MIDI Operation

3.5 Sending MIDI File Dump

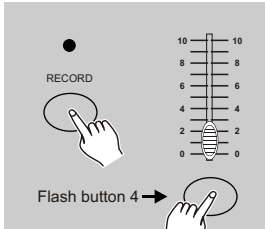

Tap this button
three times

Tap the Flash button 4 three times while holding down the Record button, the Segment Display reads "OUT" indicating the controller is ready to send a file.

NOTE:

1. During file dump, all other operations will not function. Functions will automatically return when the file dump is completed.
2. File dump will be interrupted and stop if errors occur or power failure.

3.6 Implementation

1. During receiving and sending MIDI data, all MIDI scenes and channels being run will automatically paused if there is no response within 10 minutes.
2. During receiving and sending file dump, the controller will automatically search for or send Device ID of 55H(85), a file named DC2448 with an extension of "BIN(SPACE)".
3. File dump allows this controller to send its MIDI data to next unit or other MIDI devices.

3. MIDI Operation

3.6 Implementation

4. There are two types of file dump mode described as below:

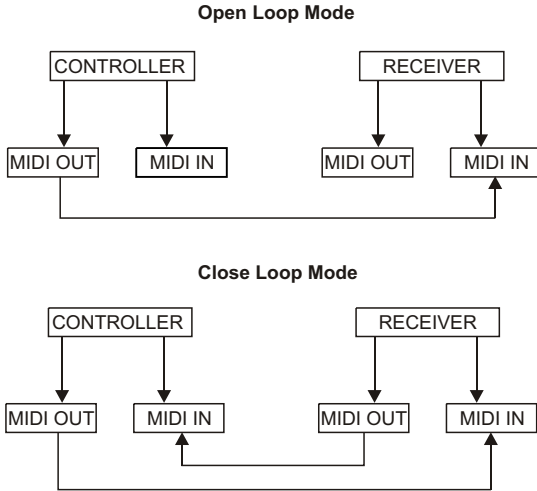

5. The controller will send and receive Note On and Note Off data via the Flash buttons.

Note NO.	Velocity	Functions
22-69	Program master	turn on or off program 1-48
70-117	Channel intensity	Activate Channel 1-48
118		FULL -ON
119		DARK
120		HOLD
121		Turn on or off AUDIO
122		CHNS ◀ ▶ SCENES
123		DOUBLE PRESET Mode
124		SINGLE PRESET Mode
125		Step
126		BLACK OUT

4. Brief of Main Functions

Reverse the direction of the scene

1. Reverse the direction of all the scenes:
Press the ALL REV Button, all the scenes should change their directions.
2. Reverse the chasing direction of all the programs with speed control.
Press the Chase Rev Button.
3. Reverse the chasing direction of all the programs with standard beat:
Press the Beat Rev Button.
4. Revers chasing direction of any program:
Press and hold down the Rec One Button, then press down the Flash Button corresponding to your desired program and release together.

Fade Time

1. The amount of time it will take for the dimmer to go from zero output to maximum output, and vice versa.
2. Fade time is adjusted through the Fade Time Slider, which varies from instant to 10 minutes.

Tap Sync Button:

1. The Tap Sync button is used to set and synchronize the chase rate (the rate at which all scenes will sequence) by tapping the button several times. The chase rate will synchronize to the time of the last two taps. The LED above the Step Button will flash at the new chase rate. The chase rate may be set anytime whether or not a program is running.
2. Tap Sync will override any previous setting of the speed slider control until the slider is moved again.
3. Use of Tap Sync in setting a standard beat is the same with speed control slider.

Master Slider

Master Slider control provides proportional level control over all channels and scenes with the exception of the Flash Buttons. For example:

Whenever the Master slider control is at minimum all stage outputs will be at zero except for any resulting from a Flash Button or FULL ON Button.

If the Master is at 50%, all outputs will be at only 50% of the setting of current channel or scenes except for any resulting from a Flash Button or FULL ON Button.

If the Master is at full all outputs will follow the unit setting.

Master A always controls outputs of channels. Master B controls the program or a scene except in Double Preset Mode.

4. Brief of Main Functions

Single Mode

1. All programs will run in sequential order starting in the order of program number.
2. The Segment Display will read the running program number.
3. All programs will be controlled by the same Speed Slider .
4. Press the MODE SELECT BUTTON and select " CHNS ◀▶ SCENES".
5. Press the PARK BUTTON to select SINGLE CHASE MODE. A red LED will indicate this selection.

Mix Mode

1. Will run all programs synchronously.
2. All programs can be controlled by the same SLIDER SPEED, or each programs speed may be controlled individually. (See Speed Setting).
3. Press the MODE SELECT BUTTON and select "CHNS ◀▶ SCENES".
4. Press the PARK BUTTON to select MIX CHASE MODE. A yellow LED will indicate this selection.

Dimmer Display

1. The 3-Digit Segment Display is used to display intensity percentage or absolute DMX value.
2. To change between percentage and absolute value:
Press and hold the Shift Button. While holding down the Shift button press the % or 0-255 Button to switch between percentage and absolute values.
3. If the Segment Display reads, for example, "076", it means a percentage value 76%.
If the Segment Display reads "076.", it means the DMX value 76.

Blind and Home

1. Blind function takes channels temporarily out from a chase, when the chase is running, and gives you manual control over the channel.
2. Press and hold the Blind Button and tap the relative Flash Button you want to temporarily take out of the chase.
3. To return to normal chase again press and hold the Home Button and push the Flash Button you want to return to normal chase.

4. Brief of Main Functions

Park

1. In CHNS ◀▶ SCENES Mode, press down the button you can change the chasing mode of programs between Single Mode and Mix Mode.
2. In Double Preset Mode, pressing down this button is equal to pushing Master Slider B to the top.
3. In Single Preset Mode, this button could temporarily record current output, with Master Slider B to adjust.

Add and Kill

The ADD/KILL Button changes the mode of the flash buttons. Normally the flash buttons are in Add mode, whereas pressing any flash button will not kill other scenes, allowing multiple scenes to be on at a time.

The Kill mode is activated by pressing the Add/Kill button and illuminating the LED above it. Pressing any flash button will kill other active SCENE or Program.

In Kill Mode, the killed program does not stop running but can not output.

Double Preset

1. Press Mode Select Button to enter A Double Preset Mode.
2. In this mode, Channel Sliders 1-24 and channel sliders 25-48 both control Channel 1-24.
3. Master A controls channel Slider 1-24 while Master B controls Channel Sliders 25-48.
4. In this Mode, no scene could be recorded.

Example

1. Enter the Double Preset Mode.
2. Push Channel Sliders 1 to 6 to the top and move Channel Sliders 19 to 24 to the maximum.
3. Move Master A and B to the same level and push them to the same direction, you will get a scene.

Technical Specifications

Power Input	DC 12~20V, 500 mA min.
DMX Output	3 pin female XLR
MIDI Signal	5 pin standard interface
Audio Input	100 mV~1Vpp
Fuse(internal)	F0.5A 250V 5x20mm
Dimensions	711x264x85mm
Weight(appro.)	7.2 kg

Attention!

1. To retain your programs from loss, this unit must be powered not less than two hour every month.
2. The Segment Display shows "LOP" if the voltage is too low.

