

# DIGITAL PRO MIXER DDM4000

## User Manual



A50-16713-00001





# DIGITAL PRO MIXER DDM4000

## Important Safety Instructions



### Caution

 To reduce the risk of electric shock, do not remove the top cover (or the rear section). No user serviceable parts inside. Refer servicing to qualified personnel.

 To reduce the risk of fire or electric shock, do not expose this appliance to rain and moisture. The apparatus shall not be exposed to dripping or splashing liquids and no objects filled with liquids, such as vases, shall be placed on the apparatus.



This symbol, wherever it appears, alerts you to the presence of uninsulated dangerous voltage inside the enclosure - voltage that may be sufficient to constitute a risk of shock.



This symbol, wherever it appears, alerts you to important operating and maintenance instructions in the accompanying literature. Please read the manual.



- 1) Read these instructions.
- 2) Keep these instructions.
- 3) Heed all warnings.
- 4) Follow all instructions.
- 5) Do not use this apparatus near water.
- 6) Clean only with dry cloth.
- 7) Do not block any ventilation openings. Install in accordance with the manufacturer's instructions.
- 8) Do not install near any heat sources such as radiators, heat registers, stoves, or other apparatus (including amplifiers) that produce heat.
- 9) Do not defeat the safety purpose of the polarized or grounding-type plug. A polarized plug has two blades with one wider than the other. A grounding-type plug has two blades and a third grounding prong. The wide blade or the third prong are provided for your safety. If the provided plug does not fit into your outlet, consult an electrician for replacement of the obsolete outlet.
- 10) Place the power cord so that it is protected from being walked on and sharp edges. Be sure that the power cord is protected particularly at plugs, convenience receptacles and the point where it exits from the apparatus.
- 11) The apparatus shall be connected to a MAINS socket outlet with a protective earthing connection.
- 12) Where the MAINS plug or an appliance coupler is used as the disconnect device, the disconnect device shall remain readily operable.
- 13) Only use attachments/accessories specified by the manufacturer.
- 14) Use only with the cart, stand, tripod, bracket, or table specified by the manufacturer, or sold with the apparatus. When a cart is used, use caution when moving the cart/apparatus combination to avoid injury from tip-over.



- 15) Unplug this apparatus during lightning storms or when unused for long periods of time.
- 16) Refer all servicing to qualified service personnel. Servicing is required when the apparatus has been damaged in any way, such as power supply cord or plug is damaged, liquid has been spilled or objects have fallen into the apparatus, the apparatus has been exposed to rain or moisture, does not operate normally, or has been dropped.

### Caution

 These service instructions are for use by qualified service personnel only. To reduce the risk of electric shock do not perform any servicing other than that contained in the operation instructions. Repairs have to be performed by qualified service personnel.

# DIGITAL PRO MIXER

Ultimate 5-Channel Digital DJ Mixer with Sampler, 4 FX Sections, Dual BPM Counters and MIDI

- ▲ 32-bit digital DJ mixer with beat-synchronized sampler, 4 multi-FX sections, 2 patented<sup>1</sup> BPM counters, digital crossfader and MIDI
- ▲ 4 Phono/Line stereo channels allowing max. 8 signal sources to be connected simultaneously
- ▲ 2 Microphone inputs with Gain, EQ, Talk function and FX
- ▲ 4 stereo channels with Gain, programmable parametric 3-band EQ with Kill function, fader curve control and flexible crossfader assignment
- ▲ Fully featured MIDI controller for your DJ software
- ▲ Sophisticated sampler with beat-controlled loop function, real-time pitch control, sampler FX and crossfader start option
- ▲ 2 freely assignable and BPM-synchronized, high-quality FX engines (Bitcrusher, Resonator, Reverb, Flanger, etc.)
- ▲ Ultra-fast, accurate and patented BPM counters for automatic BPM synchronization of sampler, FX, crossfader and external drum machines, etc. via MIDI
- ▲ Digital crossfader with flexible curve adjustment, reverse button and automatic, BPM-synchronized crossfading
- ▲ Dual-mode crossfader with innovative frequency-selective crossfading
- ▲ Dedicated Headphone section includes PFL Mix/Split and Bass/Snare boost functions
- ▲ Recall your last mixer setting at the push of a button
- ▲ Digital S/PDIF output for direct recording of your performance
- ▲ Rack mount brackets included for ultimate flexibility
- ▲ High-quality components and exceptionally rugged construction ensure long life
- ▲ Conceived and designed by BEHRINGER Germany

1) U.S. Patent No.: 6812394 / German Patent No.: 102 23 735

## Foreword



Dear Customer,  
Welcome to the team of BEHRINGER users, and thank you very much for expressing your confidence in us by purchasing this device.

Writing this foreword for you gives me great pleasure, because it represents the culmination of many months of hard work delivered by our engineering team to achieve a very ambitious goal: to design a digital DJ mixer that offers a maximum of performance thanks to its one-of-a-kind functions and intuitive control. The task of designing our new DDM4000 certainly meant

a great deal of responsibility, which we assumed by focusing on you, the discerning user and musician. Meeting your expectations also meant a lot of work and night shifts. But it was fun, too. Developing a product usually brings a lot of people together. What a great feeling it is when all who participated in such a project can be proud of what they've achieved.

It is our philosophy to share our enjoyment with you, because you are the most important member of the BEHRINGER team. With your highly competent suggestions for new products you've made a significant contribution to shaping our company and making it successful. In return, we guarantee you uncompromising quality as well as excellent technical and audio properties at an extremely reasonable price. All of this will enable you to give free rein to your creativity without being hampered by budget constraints.

We are often asked how we manage to produce such high-quality devices at such unbelievably low prices. The answer is quite simple: it's you, our customers! Many satisfied customers mean large sales volumes, enabling us to get better purchasing terms for components, etc. Isn't it only fair to pass this benefit on to you? Because we know that your success is our success, too!

I would like to thank everyone who has made the DDM4000 possible. You have all made your own personal contributions, from the developers and the many other employees at this company, to you, the BEHRINGER user.

My friends, it's been worth the effort!

Thank you very much,

Uli Behringer

## Table of contents

<b>1. Introduction.....</b>	<b>5</b>
1.1 Before you get started.....	5
1.1.1 Shipment.....	5
1.1.2 Initial operation .....	5
1.1.3 Online registration.....	5
<b>2. Controls and connections .....</b>	<b>6</b>
2.1 Stereo channels 1 – 4 .....	7
2.2 Microphone channel.....	7
2.3 Crossfader section .....	8
2.4 Main and Phones section.....	9
2.5 BPM and Effects section .....	9
2.6 Sampler.....	10
2.7 Rear panel connectors .....	10
2.8 Rear panel outputs.....	11
2.9 Power section.....	11
2.10 Hookup example .....	12
<b>3. Operation.....</b>	<b>13</b>
3.1 Console Setup.....	13
3.1.1 Selection lists on screen .....	13
3.2 Using stereo channels.....	13
3.2.1 EQ modes: SINGLE and MULTI .....	13
3.2.2 Channel Setup .....	14
3.3 Operating the Microphone channel .....	14
3.3.1 Mic Setup .....	14
3.3.2 Talk Setup .....	16
3.4 Operating the crossfader.....	16
3.4.1 Crossfader modes: KILL and X-OVER .....	16
3.4.2 Crossfader Setup.....	16
3.4.3 Bounce to MIDI Clock .....	16
3.5 Operating the Main section .....	16
3.5.1 Ultramizer .....	16
3.5.2 Loading and saving user settings .....	17
3.6 Operating the Phones section .....	17
<b>4. BPM and Effects section.....</b>	<b>17</b>
4.1 Effects section .....	18
4.1.1 Selecting the signal source .....	18
4.1.2 Activating an effect .....	18
4.1.3 Selecting an effect .....	18
4.1.4 Effect descriptions .....	18
4.1.5 Editing effects .....	19
4.1.6 BPM-synchronized effect parameters.....	19
4.1.7 FX Setup.....	20
4.2 BPM Counter.....	20
4.3 MIDI Clock.....	21
<b>5. Sampler .....</b>	<b>21</b>
5.1 Recording samples .....	21
5.2 Playing back samples .....	22
5.2.1 Insert function .....	22
5.2.2 Reverse and Loop playback .....	22
5.2.3 Crossfader start .....	22
5.2.4 Pitch Bend .....	22
5.3 Sampler effect .....	22
<b>6. Further settings .....</b>	<b>23</b>
6.1 Loading factory settings .....	23
6.2 Output Setup.....	23
6.3 Adjusting display contrast.....	23
<b>7. The DDM4000 as MIDI controller.....</b>	<b>23</b>
7.1 MIDI protocol.....	23
7.2 Common MIDI settings.....	23
7.2.1 Setting the MIDI channel .....	24
7.2.2 Sending a MIDI dump .....	24
7.3 Configuring Microphone channel, Sampler and crossfader as MIDI controller.....	24
7.4 Configuring stereo channels as MIDI controller .....	24
<b>8. Installation.....</b>	<b>24</b>
<b>9. Specifications .....</b>	<b>25</b>
<b>10. Appendix .....</b>	<b>26</b>
<b>11. Warranty .....</b>	<b>27</b>

## 1. Introduction

Congratulations! The DDM4000 is a state-of-the-art 32-bit digital DJ mixer, jam-packed with creative tools, yet its intuitive layout will let you feel at home in an instant. Editing, storing and recalling your settings is simply a breeze!

Hook up your turntables and CD/MP3 players to its 4 stereo channels, each with fully programmable EQ and Kill switches. Put ultimate versatility at your fingertips with fully programmable beat-sync'able multi-FX modules, a pair of high-precision BPM counters and a digital crossfader with custom curve adjustment. And the super-cool BPM-sync'd sampler with real-time pitch control, loop and reverse functions will make your crowd go wild.

 **Please read this manual to familiarize yourself with the control elements of the unit and its functions. After you have carefully read this manual, keep it for future reference.**

### 1.1 Before you get started

#### 1.1.1 Shipment

Your DDM4000 was carefully packed at the factory, and the packaging was designed to protect the unit from damage caused by rough handling. Nevertheless, we recommend that you carefully examine the packaging and its contents for any signs of physical damage that may have occurred during transit.

 **If the unit is damaged, please do NOT return it to us; instead, notify your dealer and the shipping company immediately, otherwise claims for damage or replacement may not be granted.**

 **We recommend using a case to ensure optimal protection of the device.**

 **Please always use the original packaging to avoid damage due to storage or shipping.**

 **Never let unsupervised children play with the DDM4000 or with its packaging.**

 **Recycle whenever possible.**

#### 1.1.2 Initial operation

Ensure adequate air supply and to avoid overheating do not place the unit near radiators etc.

 **Before you connect your DDM4000 to the mains, please make sure that your local voltage matches the voltage required by the unit.**

Caution! The following applies only to units that can be switched between 120 V and 230 V: The fuse holder on the mains connector has 3 triangular markings, with two of these triangles opposing each other. The DDM4000 is set to the operating voltage printed next to these markers and can be set to another voltage by turning the fuse holder by 180°.

 **Please note that when operating the unit at 120 V, a higher fuse rating is required. Please refer to the "Specifications" for details.**

 **If you set the unit to a different mains voltage, be sure to use a fuse of the correct type and rating. Please refer to the "Specifications" for details.**

 **Blown fuses must be replaced by fuses of the same type and rating! Please refer to the "Specifications" for details.**

## Caution!

 **Before changing the fuse, switch off the device and pull the plug to avoid electric shock or damage to the device.**

The DDM4000 power connection is made by using the enclosed cable and the amplifier's standard IEC receptacle. It meets all of the international safety certification requirements.

 **Please make sure that all units have a proper earth connection. For your own safety, never remove or disable the earth conductor from the unit or of the AC power cord.**

## IMPORTANT NOTES CONCERNING INSTALLATION

 **The sound quality may diminish within the range of powerful broadcasting stations and high-frequency sources. Increase the distance between the transmitter and the device and use shielded cables for all connections.**

#### 1.1.3 Online registration

Please do remember to register your new BEHRINGER equipment right after your purchase by visiting [www.behringer.com](http://www.behringer.com) (alternatively [www.behringer.de](http://www.behringer.de)) and kindly read the terms and conditions of our warranty carefully.

Should your BEHRINGER product malfunction, our goal is to have it repaired as quickly as possible. To arrange for warranty service, please contact the retailer from whom the equipment was purchased. Should your BEHRINGER dealer not be located in your vicinity, you may directly contact one of our subsidiaries. Corresponding contact information is included in the original equipment packaging (Global Contact Information/European Contact Information). Should your country not be listed, please contact the distributor nearest you. A list of distributors can be found in the support area of our website ([www.behringer.com](http://www.behringer.com)).

Registering your purchase and equipment with us helps us process your repair claims quicker and more efficiently.

Thank you for your cooperation!

## Caution!

 **Extreme output volumes may damage your hearing and/or your loudspeakers. Turn down all volume and level controls before you switch on the unit. Always set the volume to an appropriate level.**

## 2. Controls and connections

This chapter describes the various controls and connections of the DDM4000 mixer. We have divided the console into several functional sections for a better overview.

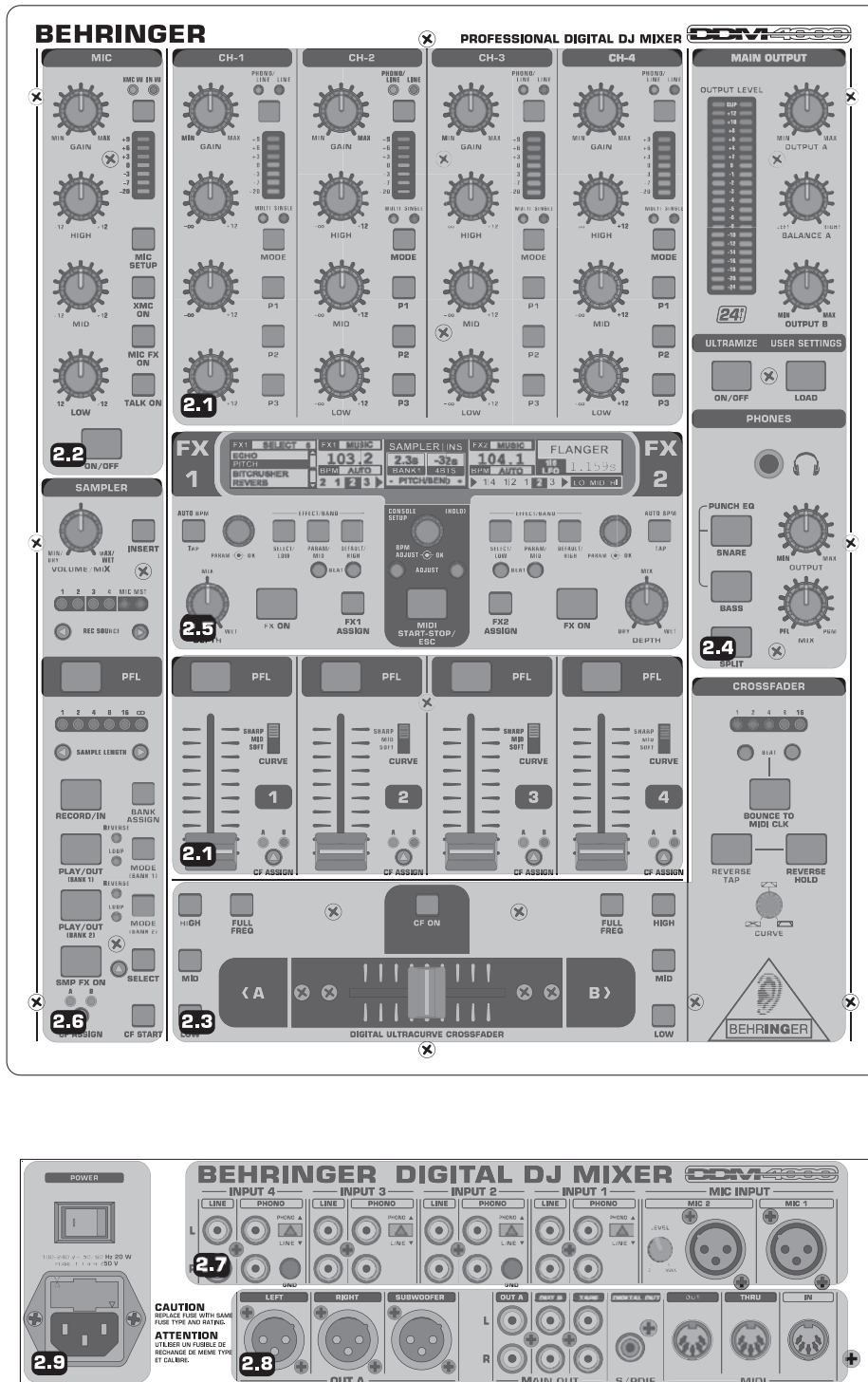

Fig. 2.0: Overview of DDM4000

- 2.1 Stereo channels 1 – 4
- 2.2 Microphone channel
- 2.3 Crossfader section
- 2.4 Main and Phones section
- 2.5 BPM and Effects section
- 2.6 Sampler
- 2.7 Rear panel connectors
- 2.8 Rear panel outputs
- 2.9 Power section

## 2.1 Stereo channels 1 – 4

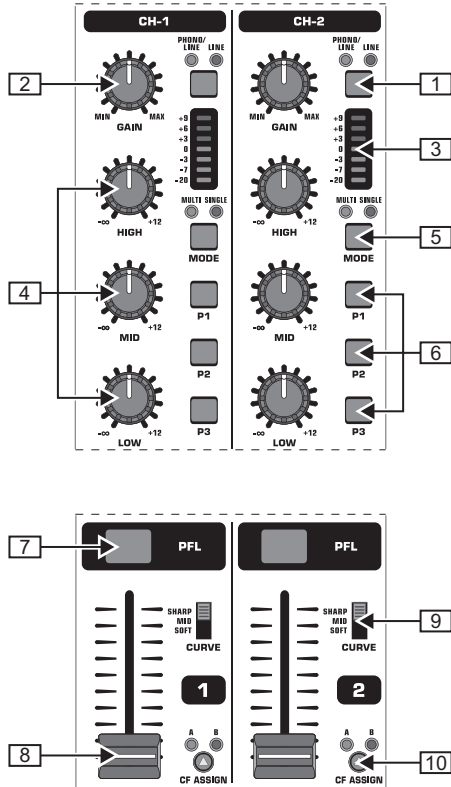

Fig. 2.1: Stereo channel strips

- 1 The input select switch lets you switch between two signal sources. Select Line to hear the signal of the Line input [67]. Select Phono/Line to listen to the incoming source signal at the Phono/Line [68] input.
- 2 The GAIN knob adjusts the level of the input signal. The actual level is displayed on the level meter [3].
- 3 The 7-segment LED meter indicates the level of the input signal.
- 4 Each input channel features a 3-band equalizer (HIGH, MID and LOW) with kill feature, giving you up to 12 dB of boost and a maximum cut of  $-\infty$  dB (kill). The kill feature lets you mute the given frequency range. When each EQ knob is turned fully left, the signal is effectively muted. All EQ parameters can be adjusted in *Channel Setup*.
- 5 The MODE push button changes the functionality of the preset push button [6] from Multi to Single.
- 6 The preset push buttons P1, P2 and P3 allow you to store and activate equalizer presets. When activated in Single Mode, these push buttons provide a maximum cut of  $-\infty$  dB (kill function).
- 7 Press the PFL push button to listen in on the channel's signal using headphones.
- 8 The fader controls the channel volume.
- 9 The CURVE switch adjusts the response of the fader. In SOFT Mode, the fader responds slower to steady fader movement in the upper range and quicker in the lower range. In Sharp Mode, the fader adjusts the volume quicker in the upper third and slower in the lower range. In MID Mode, the fader responds in a linear fashion. Since a difference in volume levels is heard when switching between modes, don't use this switch while playing music!
- 10 The CF ASSIGN push button lets you determine on which side of the crossfader [20] (A or B) the signal is to be heard.

## 2.2 Microphone channel

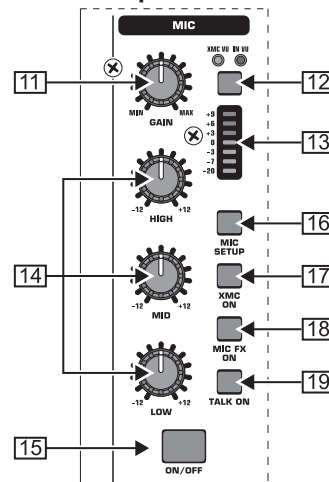

Fig. 2.2: Microphone channel

- 11 The GAIN knob adjusts the level of the microphone signal at the MIC 1 input.
- 12 This switch determines which signal is to be displayed on the level meter [13]. IN VU shows the unprocessed input level which helps you to adjust the microphone signal correctly. XMC VU shows the level after it has passed the Ultramic processor.
- 13 The 7-segment LED meter indicates the level of the microphone channel.
- 14 The microphone channel strip features a 3-band equalizer (HIGH, MID and LOW). The range is  $\pm 12$  dB.
- 15 The ON/OFF push button turns the microphone channel on and off.
- 16 The MIC SETUP push button opens the Mic Setup menu on the display. This allows you to adjust the settings of the equalizer, the Ultramic processor and the MIC FX (effects processor).
- 17 The XMC ON push button activates the ULTRAMIC processor, which includes a 2-band compressor and expander. Ultramic settings can be adjusted in *Mic Setup*.
- 18 The MIC FX ON push button activates the microphone effects processor. Select the effect in *Mic Setup*.
- 19 The TALK ON push button activates the Talkover function. This attenuates the volume level of the music as soon as you speak into the microphone. This is a very useful function to make yourself heard over the music being played. You can adjust all the relevant settings in *Talk Setup*.



## 2.3 Crossfader section

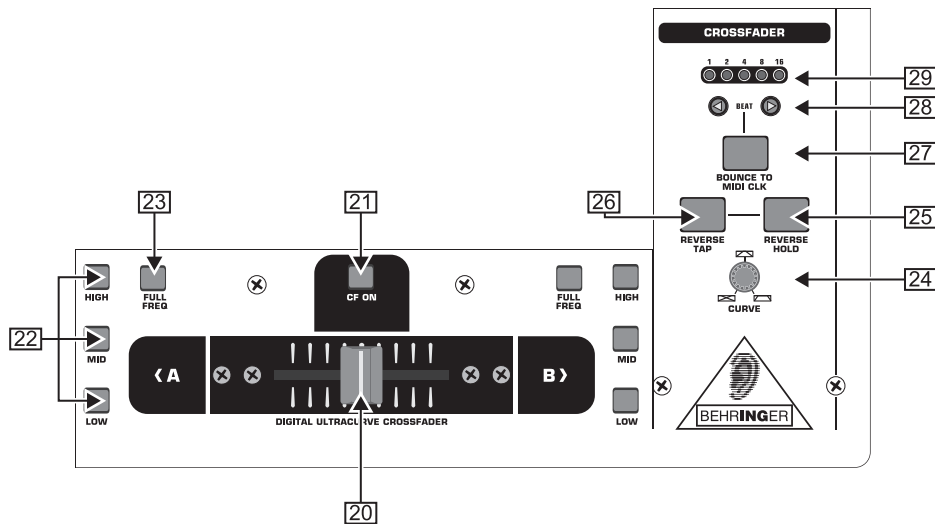

Fig. 2.3: Crossfader section

- [20] The replaceable crossfader is used to fade between the signals that are assigned to its two sides A and B. You can assign the stereo channels and sampler using the CF Assign push buttons [10] and [65].
- [21] The **CF ON** push button activates the crossfader. When the push button is not pressed, the signals of the individual channels are routed straight to the Main outputs.
- [22] There are 3 Kill push buttons (*HIGH*, *MID* and *LOW*) on each side of the crossfader which let you mute the given frequency range. In *Crossfader Setup* (see Chapter 3.4.2), it is possible to activate a special X-OVER mode that enhances the crossfader's functionality in combination with the Kill push buttons. For more information, read Chapter 3.4.1.
- [23] Press the **FULL FREQ** push button to remove any frequency cuts of the KILL EQ [22].
- [24] The **CURVE** knob lets you seamlessly adjust the response of the crossfader.

The **REVERSE** function allows you to reverse the configuration of the crossfader. This way you can toggle between Channel A and B at the flick of a switch.

- [25] **REVERSE HOLD** activates a permanent Reverse function. The crossfader fades between sides A and B in the reverse direction. This means that A is now on the right and B on the left side.
- [26] **REVERSE TAP** activates a momentary Reverse function. This means that A and B are interchanged as long as the TAP push button is held down.

The **BOUNCE TO MIDI CLOCK** function provides an automatic, quick crossfading synchronized to the rhythm of the music ("bouncing"). The bounce speed is determined by the MIDI Clock.

- [27] Press the **BOUNCE TO MIDI CLK** push button to activate the bouncing. Once the push button is pressed, the signal repeatedly jumps from A to B and back again corresponding to the interval pre-selected by using the BEAT push buttons [28].
  - [28] The **BEAT** push buttons let you determine the Bounce rate, which can range between one and 16 beats.
  - [29] These LEDs indicate the number of beats you have chosen.
- 📖 Find a detailed description of this function in Chapter 3.4.3.



## 2.4 Main and Phones section

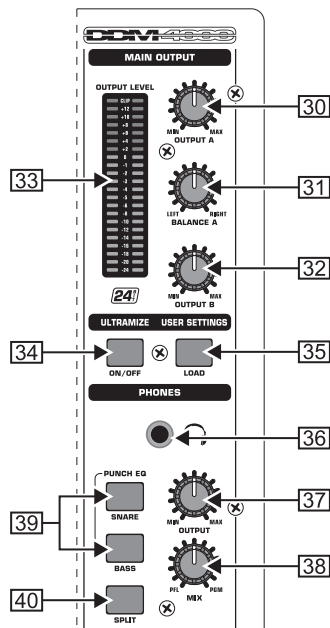

Fig. 2.4: Main and Phones section

### MAIN OUTPUT:

- [30] The **OUTPUT A** knob controls the volume of output A ([73]).
- [31] The **BALANCE** knob adjusts the stereo panning of output A.
- [32] The **OUTPUT B** knob controls the volume of output B ([74]).
- [33] The high-resolution, 22-segment **OUTPUT LEVEL** meter indicates the level of the output signal on OUTPUT A.
- [34] **ULTRAMIZE ON/OFF** push button: The Ultramizer is an effect that enhances the loudness and assertiveness by dynamic compression. In *Ultramizer Setup* (see Chapter 3.5.1), you can configure the Ultramizer.
- [35] The **LOAD** push button lets you load the user settings of the entire mixer. The settings that are active when the device is turned off are loaded when the device is switched back on again. Read more about saving and loading user settings in Chapter 3.5.2.

### PHONES:

- [36] Connect the headphones to the **PHONES** jack (1/4" TRS connector).
- [37] The **OUTPUT** knob controls the volume of the headphones.
- [38] The **MIX** knob adjusts the balance between PFL signal and PGM signal (PFL = Pre Fader Listening, fader independent pre-listening of individual channels; PGM = Program, Master signal). When the knob is turned completely to the left, you only hear the PFL signal, whereas when turned completely to the right the Master signal is heard. Between these two positions, you can adjust the mix of both signals.
- [39] The **PUNCH EQ** function helps synchronize two tracks. You can orient yourself to the snare or the bass drum or both. Press the **SNARE** or **BASS** push button to emphasize the selected sound in the headphones.
- [40] When the **SPLIT** push button is pressed, the PFL signal is heard in the left headphone and the PGM signal is only heard in the right headphone.

## 2.5 BPM and Effects section

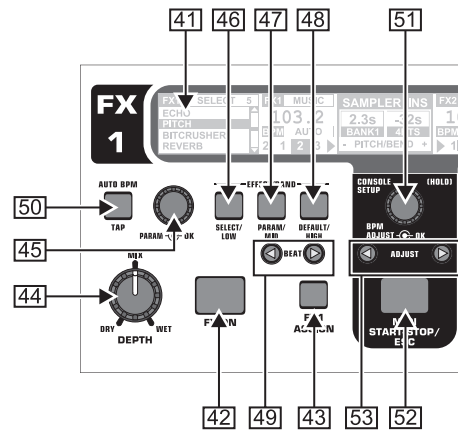

Fig. 2.5: BPM Counter and Effects section (here FX1)

The DDM4000 has 2 identical effects units. There are 2 additional independent effects units for the mic signal and the Sampler. All effects can be used at the same time. The BPM Counter and MIDI Clock are also found in this section.

- [41] The graphic display shows BPM values, effect names and effect parameters as well as channel assignments. It also leads you through Console Setup.
- [42] The **FX ON** push button activates the effects unit.
- [43] Press the **FX ASSIGN** push button to assign an effects unit to a signal source (push button flashes). The possible input sources are listed on the display. Select the preferred source by turning and pressing the **PARAMETER** knob [45].
- [44] The **DEPTH** knob adjusts the effect intensity (depth). For some effects, it also lets you adjust the mix between the original signal (dry) and the effect signal (wet).
- [45] Press the **PARAM(eter)** knob to select the effect parameters. By turning the knob, you can change the parameter shown on the display.
- [46] Press **SELECT/LOW** to access the effects list (on the display). Turn and press the knob [45] to load a preset.
- [47] Press the **PARAM/MID** push button to access the effect parameters. Turn the knob [45] to change the parameter value.
- [48] Press **DEFAULT/HIGH** to restore a preset.
- ☞ **When the effect is activated (by pressing the FX ON push button), the push buttons [46] (LOW), [47] (MID) and [48] (HIGH) are used as Kill switches in the effect's signal path.**
- [49] Depending on the selected effect, the **BEAT** push buttons can adjust time-related parameters. However, the values entered are not in milliseconds or similar units, but in beats.
- [50] To enter the tempo manually, tap this push button (at least 2 x) in the rhythm of the music (**TAP**). By keeping the **AUTO BPM/TAP** push button pressed a little longer (> 1 s), the automatic tempo input (AUTO BPM) is reactivated.
- [51] Turn the **CONSOLE SETUP** knob to adjust the tempo of the MIDI Clock (press and turn simultaneously = coarse adjustment). A short press on the knob confirms the entry made. A long press on the knob lets you access *Console Setup* (see Chapter 3.1).
- [52] The **MIDI START/STOP/ESC** turns on the MIDI Clock.
- [53] The **ADJUST** push buttons let you transfer the tempo of the BPM counter to the MIDI Clock.
- ☞ **All functions of the BPM and Effects section are described in detail in Chapter 4.**

## 2.6 Sampler

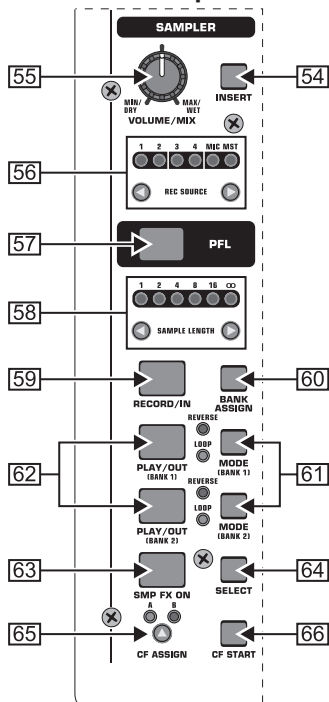

Fig. 2.6: Sampler section

- [54] Press the **INSERT** push button to add the sampler signal to the channel (Insert Mode). If the push button is not activated, the sampler is mixed to the selected channel (Mix Mode). In both cases, playback is initiated with the **REC SOURCE** push buttons. When the sampler is routed to the crossfader, the LED of the **INSERT** push button goes out.
- [55] The **VOLUME/MIX** knob controls the volume of the sampler (in Mix Mode) as well as the volume balance between input signal and Sampler (in Insert Mode).
- [56] The **REC SOURCE** push buttons let you select the channel for recording and playing back samples.
- [57] Press the **PFL** push button to listen in on the sampler signal with the headphones.
- [58] **SAMPLE LENGTH** adjusts the recording time (1 – 16 beats or endless recording ∞).
- [59] **RECORD/IN** lets you record to the Sampler. Select a bank beforehand. By pressing the push button a second time, the recording is stopped (only in ∞ Mode).
- [60] **BANK ASSIGN** is used to select a bank in which the recorded material is stored. The selected bank is indicated by the relevant **MODE** push button [61] which signalizes the readiness to record.
- [61] The **MODE** push buttons (Bank 1 and Bank 2) are used to select the sampler's types of playback (Reverse and Loop). A short tap activates or deactivates the Reverse function; pressing the push button a little longer activates or deactivates the Loop function.
- [62] Press the **PLAY/OUT** push button to start the playback of the recorded sample. When the Loop function is deactivated, the sample is only played back as long as the **PLAY** push button is pressed.
- [63] Press **SMP FX ON** push button to activate the Brake effect.
- [64] Press the **SELECT** push button to determine the length of the brake (1, 4 or 8 Beat Brake, which is shown in the center of the display).
- [65] The **CF ASSIGN** push button lets you determine on which side of the crossfader the sampler signal is to be routed to.
- [66] You can even trigger the sampler with the crossfader when the sampler is assigned to it. To order to do so, simply press

the **CF START** push button. But beforehand, use **BANK ASSIGN** to select the bank that should be played back when using the fader.

## 2.7 Rear panel connectors

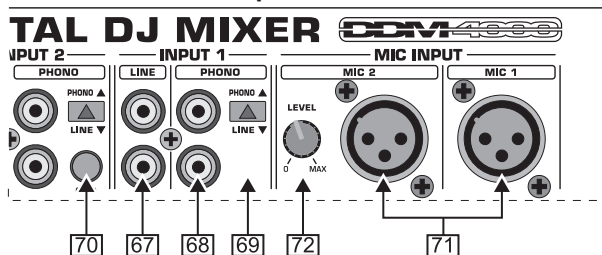



Fig. 2.7: Rear panel connectors

- [67] The **LINE** inputs are used to connect the Line signals (for example, CD players, soundcards and drum machines).
- [68] The **PHONO** inputs let you connect turntables.
- [69] Use the **PHONO/LINE** switches to set the PHONO inputs to Line level in order for you to be able to connect a CD player to the PHONO inputs.
-  **Caution!** Devices with Line output levels, such as CD players, can cause distortion and destroy the preamplifier. Press the **PHONO/LINE** switch before connecting devices with Line level to the highly sensitive PHONO inputs.
- [70] The **GND** connectors are used to ground the turntables.
- [71] The balanced XLR connectors provide a connection for dynamic microphones.
- [72] This is the **LEVEL** control for the MIC 2 input.

## 2.8 Rear panel outputs

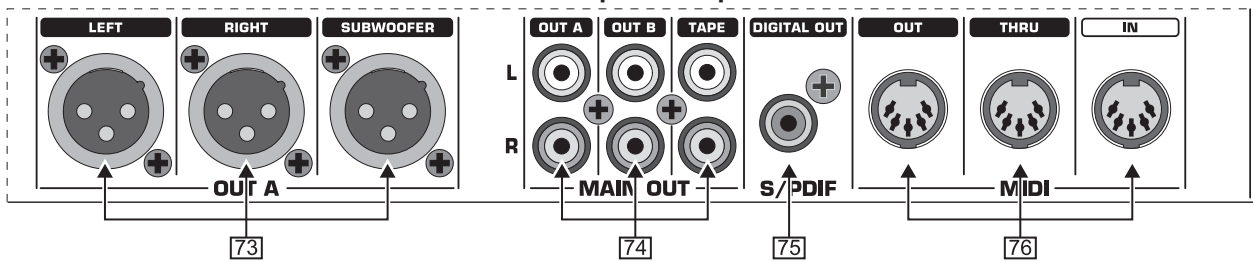

Fig. 2.8: Rear panel connectors

**73** These are the *OUT A* outputs (XLR) allowing you to connect to an amplifier. Use the *OUTPUT A* control **30** to adjust the volume level. Additionally, the *SUBWOOFER* output lets you hook up a subwoofer. A crossover is integrated into the DDM4000. The crossover frequency is adjusted in *Output Setup* (see Chapter 6.2).

**When powering up the system, turn on the connected amplifier last to prevent spikes that can easily damage your loudspeakers. Before turning on the amplifier, make sure that no signal is going through the DDM4000 in order to avoid sudden and unpleasant surprises. We recommend turning down all faders and knobs beforehand.**

**74** The *MAIN OUT* connector panel consists of *OUT A*, *OUT B* and *TAPE* outputs:

- ▲ The signal at *OUT A* is the same as at the XLR outputs **73**.
- ▲ You can connect an additional amplifier to output *OUT B* which can be used for a DJ booth or a second club zone, for example. The volume of the *OUT B* signal is (independent of *OUT A*) individually adjusted with the *OUTPUT B* knob **32**.
- ▲ The *TAPE* output allows you to connect a recording device in order to tape-record your mix. The output level is independent of *OUT A* and *OUT B* and can be adjusted in *Output Setup* (see Chapter 6.2).

**75** *DIGITAL OUT* is the digital output of the DDM4000. This is where you find the *TAPE* signal in CD quality (16 bit/44.1 kHz).

**Use Output Setup (see Chapter 6.2) to adjust further settings of the output section.**

**76** These are the *MIDI IN*, *MIDI OUT* and *MIDI THRU* connectors that allow you to connect external MIDI equipment and synchronize with their MIDI Clock.

**Read more about the MIDI functions of the DDM4000 in Chapter 7.**

## 2.9 Power section

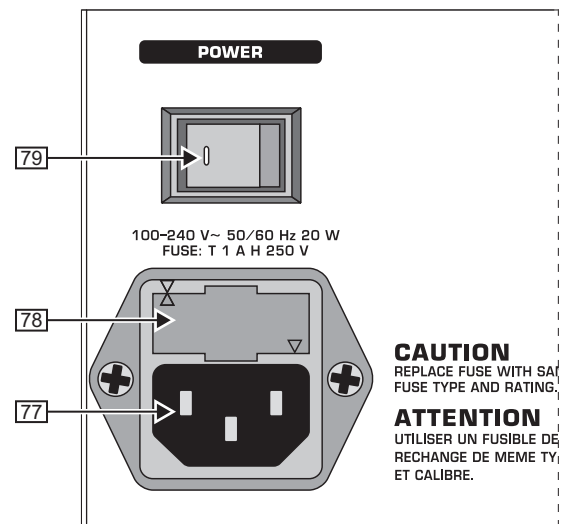

Fig. 2.9: The POWER section

**77** Power is supplied via an IEC connector. The matching cable is provided with the unit.

**78** *FUSE RETAINER/VOLTAGE SELECTOR*. Please make sure that the voltage indicated by the voltage selector matches the local voltage before you connect the unit to the main power supply. Always replace blown fuses with fuses of the same type and rating. Some units feature a fuse retainer in which a selection between 230 V and 120 V is possible. Please be aware: When using your unit outside of Europe with 120 V, a fuse with a higher rating is required.

**79** Use the *POWER* switch to turn on the DDM4000. Before connecting the unit to the power mains, ensure that the *POWER* switch is in OFF position. When the unit is in operation, ensure that the mains plug is accessible.

**Attention: The POWER switch does not fully disconnect the unit from the mains. To disconnect the unit from the mains, pull out the main cable plug or appliance coupler. When installing the product, ensure the plug or appliance coupler is readily operable. Unplug the power cord completely when the unit is not used for long periods of time.**

The serial number of the DDM4000 is found on the bottom side of the device.

# DIGITAL PRO MIXER DDM4000

## 2.10 Hookup example

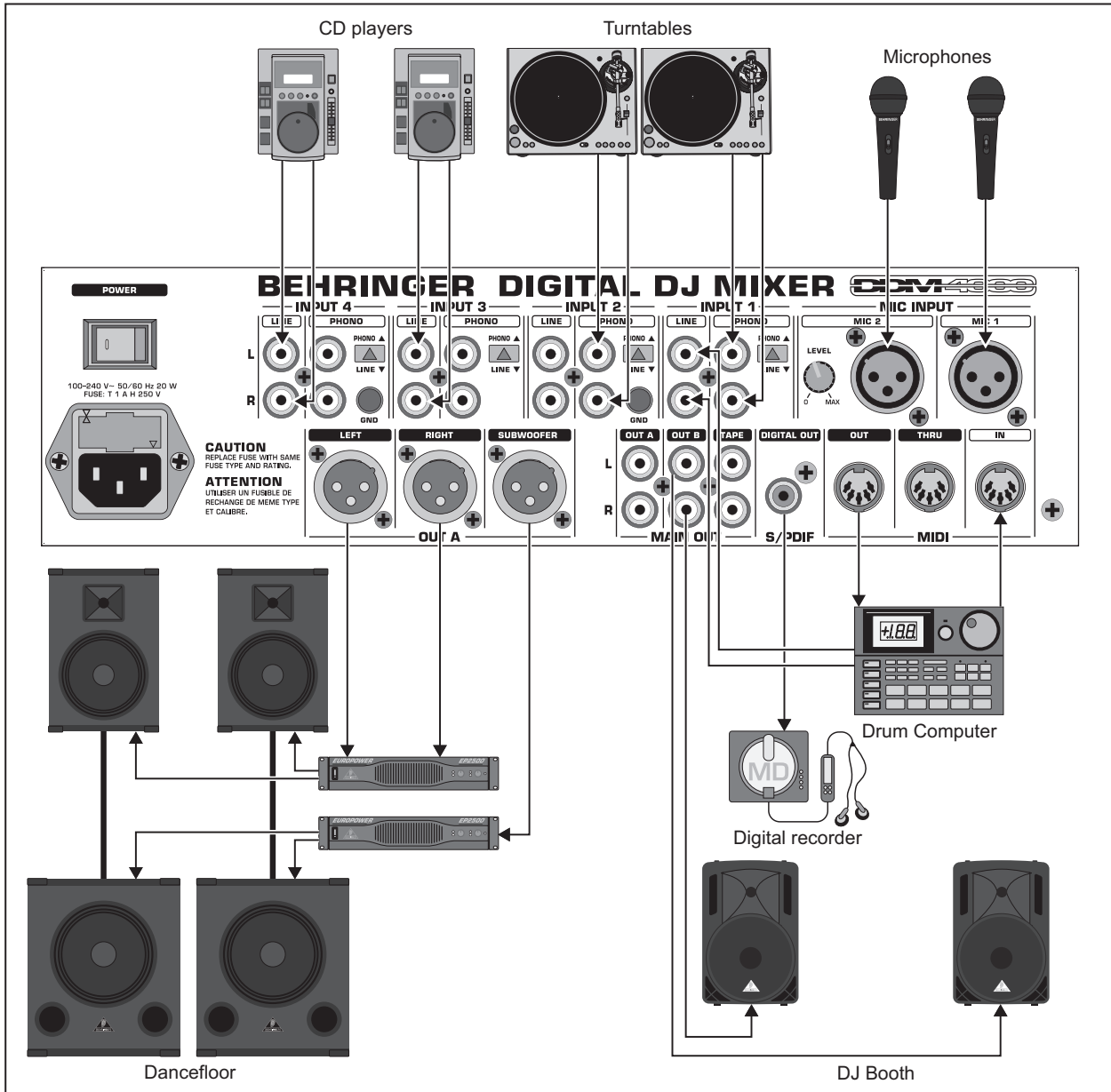

Fig. 2.10: Application example of hooking up the DDM4000

## 3. Operation

### 3.1 Console Setup

Console Setup allows you to make all standard settings for the DDM4000.

- 1) Press the CONSOLE SETUP knob [51] for approximately 2 seconds. The setup list appears in the center of the display.:

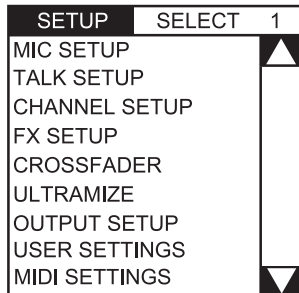

- 2) Turn the CONSOLE SETUP knob to select the setup you want to edit.
- 3) Press the CONSOLE SETUP knob to confirm the selection.

#### Exit Console Setup:

- ▲ Press the ESC push button [52] to exit Console Setup.

Some of the setup pages can be accessed in different ways. This is the case for Mic Setup and User Settings:

#### Open Mic Setup:

- 1) Press the MIC SETUP push button [16] to access Mic Setup.
- 2) Press the MIC SETUP push button [16] again to exit Mic Setup.

#### Open User Settings:

- 1) Press the LOAD push button [35] to access User Settings.
- 2) Press the LOAD push button [35] again to exit User Settings.

#### 3.1.1 Selection lists on screen

The individual setup pages contain further selection lists, which appear either on the left or right side of the display, in addition to the Console Setup list.

##### Left:

- 1) Turn the left PARAMETER knob [45] (in the FX1 section) to select the preferred function from the list.
- 2) Press the left PARAMETER knob to confirm the selection.

##### Right:

- 1) Turn the right PARAMETER knob [45] (in the FX2 section) to select the preferred function from the list.
- 2) Press the right PARAMETER knob to confirm the selection.

## 3.2 Using stereo channels

### 3.2.1 EQ modes: SINGLE and MULTI

The equalizer provides Preset push buttons, labeled P1, P2 and P3, with which preset configurations are stored. The behavior of the push buttons depend on the selected EQ mode: Single Mode or Multi Mode. After switching on the device, Single Mode is active.

#### SINGLE Mode:

In Single Mode, the push buttons P1, P2 and P3 [6] are each permanently assigned to a frequency band (P1 = HIGH, P2 = MID, P3 = LOW). This means that a Preset can be assigned to each EQ control. When activated, the Preset push buttons provide a Kill function with maximum attenuation (-∞ dB).

Preset settings in SINGLE Mode		
P1	HIGH Kill -∞ dB	Suppresses high frequencies
P2	MID Kill -∞ dB	Suppresses mid frequencies
P3	LOW Kill -∞ dB	Suppresses low frequencies

Tab. 3.1: Functionality of Preset push buttons in Single Mode

The degree of cut can, however, be modified. Alternatively, a frequency boost can also be stored. In case you want to boost instead of cutting the bass (Punch function), proceed as follows:

- 1) Turn the LOW knob [4] to the right until you have reached the boost you want.
- 2) Press and hold the MODE push button [5] while pressing P3 [6].
- 3) Press P3 to load the Preset. The bass frequencies are now boosted. P3 flashes blue.

This way you can also program the mids and highs with P2 and P1 respectively.

#### Reset:

The Preset push buttons can be restored to their initial states at all times (Reset function):

- ▲ Press MODE [5] for approximately 2 seconds. The MULTI LED briefly lights up to confirm the reset.

#### MULTI Mode:

In Multi Mode, the Preset push buttons are not assigned to individual EQ bands, but are assigned to the 3-band equalizer as a whole. This way you can create three EQ presets and assign these to the Preset push buttons. When activated, the Preset push buttons are assigned as follows:

Preset settings in MULTI Mode		
P1	High pass	Suppresses MID and LOW
P2	Band pass	Suppresses HIGH and LOW
P3	Low pass	Suppresses HIGH and MID

Tab. 3.2: Functionality of Preset push buttons in Multi Mode

- ▲ To activate Multi Mode, press the MODE push button [5]. The MULTI LED lights up.

To create your own EQ presets, proceed as follows:

- 1) Adjust the equalizer as needed by turning the LOW, MID and HIGH knobs.
  - 2) Press and hold the MODE push button [5] while pressing P1 [6].
  - 3) Press P1 to load the EQ Preset. P1 flashes yellow.
- Two more EQ Presets can be stored with P2 and P3.

#### Reset:

The Preset push buttons can be restored at all times:

- ▲ Press MODE for approximately 2 seconds. The SINGLE LED briefly lights up to confirm the reset.



# DIGITAL PRO MIXER DDM4000

## 3.2.2 Channel Setup

In Channel Setup, you can fine-tune the characteristics of the stereo channels' equalizer. It is also possible to adjust a Subsonic Filter (low-cut filter) for all four channels. For example, this filter can be used to suppress low-frequency noise from turntables.

- 1) Press the CONSOLE SETUP knob [51] for approximately 2 seconds.
- 2) Select "Channel Setup" by turning and pressing the CONSOLE SETUP knob.

Channel Setup appears on the display.

CHANNEL XOVER			MID Q.	SUBSONIC FREQ.			
LOW	MID	HIGH	QUAL MID	CH-1	CH-2	CH-3	CH-4
200Hz	1200Hz	8000Hz	1.00	OFF	OFF	30Hz	30Hz

The equalizer of the stereo channels has 3 bands with different characteristics. The Mid band is a peak filter whose center frequency and bandwidth (Q factor) can be modified. Both outer bands Low and High are shelving filters. In Channel Setup, following settings are available for each of the 4 channels:

### Channel Xover (Crossover):

- LOW:** Cutoff frequency of the Low filter. All frequencies below the adjusted value are cut or boosted.
- MID:** Center frequency of the Mid band. All frequencies around this value are boosted or cut. The bandwidth is determined by the parameter Mid Q (see below).
- HIGH:** Cutoff frequency of the High filter. All frequencies above the adjusted value are boosted or cut.

- 1) Press the left PARAMETER knob [45] to select the parameter (LOW, MID or HIGH).
- 2) Turn the PARAMETER knob to change the cutoff frequency and center frequency of the selected band.

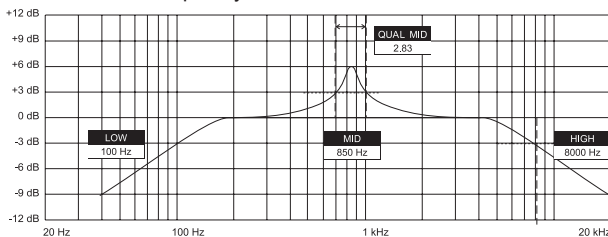

### Mid Q:

The Q factor determines the behavior of the filter. The higher the value, the narrower the bandwidth. Mid Q affects the mids band.

- ▲ Turn the CONSOLE SETUP knob [51] to change the value of the Q factor.

### Subsonic frequency:

You can adjust the cutoff frequency of the low-cut filter on each stereo channel. All frequencies below the cutoff frequency are attenuated.

- 1) Press the right PARAMETER knob [45] to select the channel.
- 2) Turn the PARAMETER knob to change the cutoff frequency.

### Exiting Channel Setup:

- ▲ Press the ESC push button [52] to exit Channel Setup.

## 3.3 Operating the Microphone channel

### 3.3.1 Mic Setup

You can make adjustments to the sound settings of the Microphone channel, the Ultramic processor and the Mic effects by using Mic Setup. This is how to access Mic Setup:

- 1) Press the CONSOLE SETUP knob [51] for approximately 2 seconds.
- 2) Select "Mic Setup" by turning and pressing the CONSOLE SETUP knob.

Alternatively, you can access Mic Setup as follows:

- ▲ Press the MIC SETUP push button [16] on the microphone channel. The MIC SETUP push button lights up as long as you are using Mic Setup.

Mic Setup appears on the display containing several submenus. On the left-hand side of the display you see a list from which the following submenus can be selected:

MIC SETUP	No 1
EQ FREQ/PAN	▲
EQ GAIN	
ULTRA-MIC1	
ULTRA-MIC2	
MIC FX	▼

- ▲ Turn the left PARAMETER knob [45] to select the submenu you want to edit:

### EQ Freq/Pan page:

MIC SETUP No 1	MIC1	MIC2	EQ FREQ/PAN				PAN1	PAN2	OUT B
EQ GAIN			LOW	MID	HIGH	Q.MID	20L	LR	-10.0dB
ULTRA-MIC1			100Hz	1200Hz	8000Hz	1.00			
ULTRA-MIC2									

This page shows level meters for both microphone signals. In addition, you can make sound settings for the equalizer on the Microphone channel. Here you can adjust the stereo image of the microphone signal as well as the signal relation of both microphones to each other. The individual parameters are as follows:

- MIC1: Level meter for Microphone 1
- MIC2: Level meter for Microphone 2
- LOW: Cutoff frequency of the LOW control knob
- MID: Center frequency of the MID control knob
- HIGH: Cutoff frequency of the HIGH control knob
- Q MID: Q factor of the mids band

- 1) Press the CONSOLE SETUP knob [51] to select the parameter (LOW, MID, HIGH, Q MID).
- 2) Turn the CONSOLE SETUP knob to change the value of the selected parameter.

- PAN1: Position of Microphone 1 in the stereo image
- PAN 2: Position of Microphone 2 in the stereo image
- OUT B: Volume of the microphone channel at Output B

- 1) Press the right PARAMETER knob [45] to select the parameter (PAN 1, PAN 2, OUT B).
- 2) Turn the PARAMETER knob to change the value of the parameter.

### EQ GAIN page:

MIC SETUP No 2	MIC1			MIC2				
EQ FREQ/PAN	L-CUT	LOW	MID	HIGH	L-CUT	LOW	MID	HIGH
EQ GAIN	OFF	.0dB	.0dB	.0dB	OFF	.0dB	.0dB	.0dB
ULTRA-MIC1								
ULTRA-MIC2								

This page lets you make user default sound settings, which affect the microphone channel in relation to the equalizer. For example, storing a boost of 5 dB in these settings affects the signal even when the HIGH rotary knob is set to 0, that is the center position. The high frequencies can additionally be boost or cut with the HIGH knob. This function helps to remove problematic frequencies of your voice or to improve speech comprehensibility.

MIC1 LOW CUT: Cutoff frequency of the high-pass filter (Microphone 1)  
 MIC1 LOW, MID, HIGH: EQ default settings for Microphone 1

- 1) Press the CONSOLE SETUP knob [51] to select the parameter (LOW, MID, HIGH).
- 2) Turn the CONSOLE SETUP knob to change the value of the selected parameter.

MIC2 LOW CUT: Cutoff frequency of the high-pass filter (Microphone 2)

MIC2 LOW, MID, HIGH: EQ default settings for Microphone 2

- 1) Press the right PARAMETER knob [45] to select the parameter (LOW, MID, HIGH).
- 2) Turn the PARAMETER knob to change the value of the selected parameter.

### ULTRAMIC 1 and 2:



The Ultramic processor is a 2-band compressor that reduces the dynamic range of speech. The level of loud sounds is reduced and the level of quiet sounds is raised. This decreases the difference between the loudest and quietest passages. By splitting the signal into two frequency bands, a thicker, more powerful sound is achieved without the typical artifacts, such as pumping sound or a loss of clarity.

The settings for both microphone signals are made separately. That's the reason for having two Ultramic pages. For Mic 1, select the page "Ultramic 1" and choose "Ultramic 2" for Mic 2. The parameters on both pages are identical so that they only have to be described once.

You can see several level meters on the display. Three parameters of the compressor are adjustable plus you can also load presets.

The meters:

- MIC I Shows the input level
- MIC 0 Shows the output level
- COM Shows the compression ratio for the low (L) and high (H) frequency band
- EXP Shows the attenuation of the expander for the low (L) or high (H) frequency band

Adjustable parameters

- THRSH Threshold specifies the cutoff frequency of the Ultramic processor
- FREQ Adjusts the crossover frequency between the upper and lower frequency band
- EFFIC Efficiency: Adjusts the level of compression

- 1) Press the CONSOLE SETUP knob [51] to select the parameter (THRSH, FREQ, EFFIC).
- 2) Turn the CONSOLE SETUP knob to change the value of the selected parameter.

Ultramic presets:

The following default settings can be loaded:

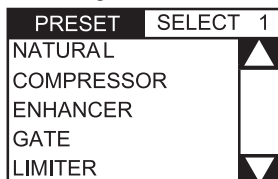

- 1) Turn the right PARAMETER knob [45] to select the preset.
- 2) Press the PARAMETER knob to load the preset.

### MIC FX page:



On the Mic FX page, you can select the type of effect you want to use for the microphone signal. The following effects are available:

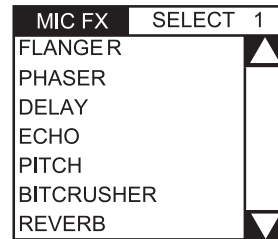

- 1) Turn the right PARAMETER knob [45] to select the preset.
- 2) Press the PARAMETER knob to load the preset.

Each effect can be modified in order to suit your individual taste. Two parameters are available for this reason. The second parameter always adjusts the effect Dry/Wet Mix—this applies to all effects.

Effect descriptions:

**FLANGER:** A flanger effect occurs through frequency modulation. You can adjust the speed of the LFO (Low Frequency Oscillator).

**PHASER** is similar to a flanger. Only this time around, modulation is achieved through phase-shifting. You can adjust the speed of the LFO.

**DELAY** is a signal delay. You can change the delay time (Time).

**ECHO** is similar to the delay effect, with the difference that the delayed signal is repeated several times.

**PITCH** changes the pitch of the signal and therefore the pitch of the vocalist's and speaker's voice. Shift is used to adjust the pitch.

**BITCRUSHER** reduce the digital resolution. The bit depth is adjustable.

**REVERB** is a reverberation effect. Eight different types of reverberation are available. These are described in detail in Chapter 4.1.4.

- 1) Press the CONSOLE SETUP knob [51] to select a parameter.
- 2) Turn the CONSOLE SETUP knob to change the value of this parameter.

You can match the time parameter of the flanger, phaser, delay and echo effects to the beat by tapping the tempo with the left TAP push button [50] as long as Mic Setup is displayed (MIC SETUP push button [16] shines when active).

### Exiting Mic Setup:

- ▲ Press the ESC push button [52] to exit Mic Setup.



# DIGITAL PRO MIXER DDM4000

## 3.3.2 Talk Setup

The Talkover function is useful when making announcements while the music is playing. The level of the music, is attenuated as soon as you speak into the microphone. All necessary settings of this function are made in Talk Setup. This is how you access Talk Setup:

- 1) Press the CONSOLE SETUP knob [51] for approximately 2 seconds.
- 2) Select "Talk Setup" by turning and pressing the CONSOLE SETUP knob.

The Talk Setup page appears on the display.



This page displays level meters for both microphones. On the left-hand side of the screen, there is a list from which you can select a Talkover preset.

### Loading presets:

- 1) Turn the left PARAMETER knob [45] to select the preset.
- 2) Press the PARAMETER knob to load the preset.

### Editing talkovers:

The following parameters of the Talkover function are adjustable:

THRSH	Threshold. The music signal is attenuated as soon as the microphone signal exceeds this value.
MAX. ATT	Maximum Attenuation. This lets you adjust the music's maximum attenuation while speaking into the microphone.
SPEED	Adjusts the speed at which the signal's volume level is reduced.

- 1) Press the right PARAMETER knob [45] to select the parameter (THRSH, MAX. ATT, SPEED)
- 2) Turn the PARAMETER knob to change the value of the parameter.

### Exiting Talk Setup:

- ▲ Press the ESC push button [52] to exit Talk Setup.

## 3.4 Operating the crossfader

The use of the Crossfader is easy to understand, even for a DJ novice. But the DDM4000 wouldn't be a digital mixer if it hadn't a couple of special functions to offer that cannot be easily realized with an analog DJ Mixer.

### 3.4.1 Crossfader modes: KILL and X-OVER

There are three push buttons labeled HIGH, MID and LOW ([22]) on the left-hand side and on the right-hand side of the Crossfader. When activated, they function as Kill switches, that is they can suppress specific frequency bands.

X-Over (Crossover) Mode lets you realize completely new, breathtaking effects. In this mode, it is possible to assign specific frequency bands to Side A and B that can then be crossfaded. Here's an example to make the functionality clear:

- 1) Move the crossfader [20] to the left (A).
- 2) Press the FULL FREQ push button [23] in Section A.
- 3) Press the Kill push button [22] "MID" in Section B.

In the left crossfader position, the A signal is played back in its complete frequency range. By moving the crossfader to the right, only the mid frequencies of the B signal are faded in while the mids of the A signal are faded out. The low and high frequencies of the A signal remain audible. As a result, the low and high frequencies of the A signal together with the mid frequencies of the B signal are audible at the output of the mixer. X-Over Mode keeps your mixing style fresh and unique. You can activate X-Over Mode in Crossfader Setup.

## 3.4.2 Crossfader Setup

This is how you access Crossfader Setup:

- 1) Press the CONSOLE SETUP knob [51] for approximately 2 seconds.
- 2) Select "Crossfader Setup" by turning and pressing the CONSOLE SETUP knob.

The Crossfader Setup page appears on the display:



On the display's left side, you can adjust the frequency crossfade of the Kill push buttons. On the right side, you can select Crossfader Mode.

### XOVER CF (Crossover Center Frequency):

LOW: Crossover frequency between LOW and MID

HIGH: Crossover frequency between MID and HIGH

- 1) Press the left PARAMETER knob [45] to select the parameter (LOW, HIGH).
- 2) Turn the PARAMETER knob to change the value for the selected parameter.

### Crossfader Mode:

- 1) Turn the right PARAMETER knob [45] to select the mode (KILL, X-OVER).
- 2) Press the PARAMETER knob to confirm.

### Exiting Crossfader Setup:

- ▲ Press the ESC push button [52] to exit Crossfader Setup.

## 3.4.3 Bounce to MIDI Clock

This function automates bouncing. Bouncing is hard crossfading with the crossfader in the rhythm of the music. The internal MIDI Clock needs to be active for this function to work. The clock is a reference for the bounce speed that ranges between one and 16 beats.

Before pressing the BOUNCE TO MIDI CLK push button to start the bounce, you should specify a the Bounce speed:

- 1) Start the MIDI Clock by pressing MIDI START-STOP push button [52].
- 2) Select the bounce speed by using the BEAT push buttons [28]. The LEDs [29] indicate the beats.
- 3) Now press the BOUNCE TO MIDI CLK push button [27] to start the bounce. When the crossfader is on Side A, the bounce starts with the A signal, whereas when the crossfader is on B, the bounce starts with the B signal.

## 3.5 Operating the Main section

There are also several functions in the Main section that surpass the functional capacity of an analog mixer. This way complete mixer settings can be stored and loaded. And the Ultramizer makes sure that your beats sound even fatter.

### 3.5.1 Ultramizer

The Ultramizer is a multiband processor that compresses the audio signal in order to achieve a better perception of volume without having to increase the level. As a result, the performance of an amplifier is optimally used and your music feels louder than it really is. The processing takes place in two individual frequency bands in order to achieve a more powerful sound without the unwanted side effects, such as the pumping effect and loss of high frequencies.

- 1) Press the ULTRAMIZE ON/OFF push button [34] to activate the Ultramizer.
- 2) Press the CONSOLE SETUP knob [51] for approximately 2 seconds.
- 3) Select "Ultramize" by turning and pressing the CONSOLE SETUP knob.



The display switches to the Ultramizer page. Here you can change settings plus load and edit presets:

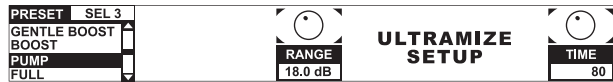

### Loading presets:

- 1) Turn the left PARAMETER knob [45] to select the preset.
- 2) Press the PARAMETER knob to load the preset.

Ultramizer presets	
Gentle Boost	Gentle volume boost
Boost	Noticeable volume boost
Pump	Strong volume boost with pumping effect
Full	Maximum volume boost
Full Pump	Maximum volume boost with pumping effect

### Editing the Ultramizer:

**RANGE** Describes the adjustable dynamic range. A value of 10 dB results in a maximum level boost of 10 dB.

**TIME** Changes the adjustable speed of the Ultramizer.

- ▲ Turn the CONSOLE SETUP knob [51] to change the TIME parameter.
- ▲ Turn the PARAMETER knob [45] to change the RANGE parameter.

### Exiting the Ultramizer setup:

- ▲ Press the ESC push button [52] to exit the Ultramizer setup.

### 3.5.2 Loading and saving user settings

A great advantage of a digital mixer is the possibility to store entire mixer settings in order to recall them later on at the flick of a switch. Big studio consoles refer to this function as “Snapshot” because all settings are captured (as with a snapshot). This lets you adjust the mixer to your way of working and recall settings you made at any time.

Just imagine, a club has the DDM4000 which is being used by several DJs. Each DJ has stored personal EQ settings, kill frequencies, Ultramizer and Effect settings, so that when it is his or her turn, the preferred settings can be recalled immediately. The other way around, a guest DJ, who is not accustomed to the DDM4000, is able to take off without having to adjust any settings in advance.

- 👉 **After switching on the device, the last selected preset is loaded.**

### Loading user settings:

- 1) Press the LOAD push button [35]. The LOAD push button flashes.

“User Setup” appears on the screen, displaying the preset list:



- 2) Turn the left PARAMETER knob [45] to select a user setting (or the factory preset).
- 3) Press the PARAMETER knob again to load the user setting.

### Storing user settings:

- 1) Press the LOAD push button [35] to access User Setup with its preset list.
- 2) Turn the CONSOLE SETUP knob [51] to select a memory location.
- 3) Press the CONSOLE SETUP knob to store the user setting.

- 👉 **It is not possible to overwrite the factory preset.**

### Exiting User Setup:

- ▲ Press the LOAD push button [35] or the ESC push button [52] to exit User Setup.

## 3.6 Operating the Phones section

You can use the headphones to listen to two different signals: 1. The PGM signal (=Program): This is the signal at the MAIN output. 2. The PFL signal (=Pre Fader Listen): This is the signal which can be routed to the PFL bus by using the PFL push buttons [7]. The PFL signal is fader-independent, which means it can even be heard when the faders are pulled down.

When the SPLIT push button [40] is not pressed, both the PGM and PFL signal are played back in stereo in the headphones. The mix of both signals is adjusted with the MIX knob [38]. When the knob is turned completely to the left, the PFL signal is heard, whereas when turned completely to the right, the PGM signal is heard in both headphones.

### Working in Split Mode:

- ▲ Press the SPLIT push button [40] to activate Split Mode.

When using Split Mode, the PFL signal is played back on the left headphone while the PGM signal is played back on the right headphone (both mono signals).

## 4. BPM and Effects section

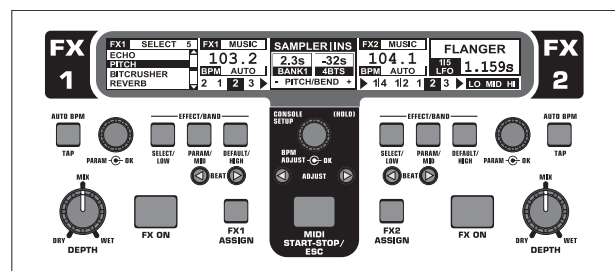
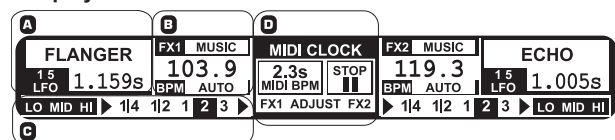

Fig. 4.1: BPM and Effects section

The BPM and Effects section in the middle of the mixer can either be used for the stereo channels or the master signal. Both processors can also be combined to be used as dual effect for individual channels. What’s more, both Microphone channel and Sampler feature their own effect processors, which are described in individual chapters (Chapter 3.3.1 and Chapter 5.4).

### Display:



The display shows the following information:

- A Shows the effect type and the parameter values.
- B Shows the calculated speed in BPM (Beats Per Minute). It also gives information on the signal assignment and the Tap function.
- C This section shows the BPM-synchronized effect parameters as beats on the right side. On the left, you see the activity of the Kill function in the effect path.
- D This information refers to the Sampler and/or the MIDI Clock (see Chapter 5).

## 4.1 Effects section

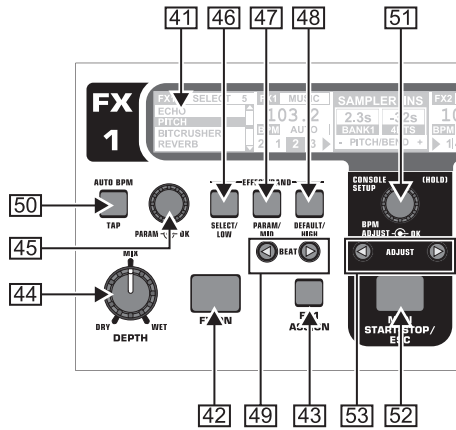

Fig. 4.2: Effects section (here FX 1)

### 4.1.1 Selecting the signal source

To use an effect, you first have to assign the effect to a signal source. This assignment also applies to the BPM Counter. Possible input sources are as follows:

FX 1	ASSIGN
	INPUT 1
	INPUT 2
	INPUT 3
	INPUT 4
	MUSIC CHAIN

- INPUT 1 – INPUT 4: Stereo channels 1 – 4.
- MUSIC: Stereo sum signal (main signal).
- CHAIN: CHAIN assigns the effect to the signal of the other effects section, so that 2 effects are triggered consecutively.

#### Selecting a signal for FX1:

- 1) Press the FX1 ASSIGN push button [43].
- 2) Turn the left PARAMETER knob [45] to select a signal source from the list.
- 3) Press the left PARAMETER knob to confirm the selection.

#### Selecting a signal for FX2:

- 1) Press the FX2 ASSIGN push button [43].
- 2) Turn the right PARAMETER knob [45] to select a signal source from the list.
- 3) Press the right PARAMETER knob to confirm the selection.

### 4.1.2 Activating an effect

- 1) Press the FX ON push button [42] to activate the effect. Both the FX ON push button and the EFFECT/BAND push button [46] – [48] flash.
- 2) Turn the DEPTH knob slowly to the right until you hear the effect as is intended.

#### Kill function on the effect path:

A specially effective way of alienation is to remove individual frequency bands from the effect processing. There are three additional Kill switches that are found on the signal path leading to the effects unit. The EFFECT/BAND push buttons of the activated effect flash blue corresponding to the frequency bands that are active. By pressing the push buttons you are able to "kill" the frequency bands. And the display shows the Kill function's status.

- ▲ Press one of the EFFECT/BAND push buttons ([46], [47], [48]) while the effect is active. The push-button LED of the deactivated band goes out.

### 4.1.3 Selecting an effect

Nine effect types are available. The effect table in Chapter 4.1.4 gives an overview of the possible effects and their adjustable parameters.

- 1) Press the SELECT push button [46]. The display shows a list of all types of effects.

FX 1	SELECT
	FLANGER
	PHASER
	DELAY
	ECHO
	PITCH
	BITCRUSHER
	REVERB
	PAN
	FILTER

- 2) Turn the PARAMETER knob [45] to select the effect type.
- 3) Press the PARAMETER knob to load the effect type.

### 4.1.4 Effect descriptions

The following gives you a description of the available effects and adjustable parameters. (BPM-synchronized parameters are printed in *italic*.) The tables show you which controls are used to adjust the parameters. Chapter 4.1.5 describes effect processing. Chapter 4.1.6 gives you the information you need to know about BPM-synchronized parameters.

#### FLANGER, PHASER, PAN:

**FLANGER:** The flanger effect is achieved by frequency modulation. You are able to adjust the speed of the *LFO* (Low Frequency Oscillator), the amount of the effect signal that is fed back to the input (**Feedback**), the effect depth (**Depth**) and the degree of phase shifting represented in rhythmical units (**Phase**). Use **Fade** in case you want the flanger to complete its period of oscillation after the effect has been turned off, to avoid an abrupt truncation of the effect.

**PHASER** is similar to the flanger. In this case the modulation is achieved through phase shifting. You can adjust the speed of the *LFO* and the effect depth (**Depth**). Use **Fade** to determine if the effect is to end abruptly or softly fade out.

**PAN** specified an effect which lets the signal move from the right to the left side of the stereo image. This effect sounds the most intensive when the DEPTH knob is turned right up. *LFO* adjusts the speed of the panning and **Depth** adjusts the effect depth.

1/5	2/5	3/5	4/5	5/5	MIX
BEAT					
PARAM - OK	PARAM - OK	PARAM - OK	PARAM - OK	PARAM - OK	DEPTH
FLANGER					
LFO Speed	Feedback	Depth	Phase	Fade	Dry/Wet Mix
PHASER					
LFO Speed	Depth	Fade	-	-	Dry/Wet Mix
PAN					
LFO Speed	Depth	-	-	-	Dry/Wet Mix

Tab. 4.1: Effect parameters for Flanger, Phaser and Panning

#### DELAY, ECHO:

**DELAY** is a signal delay. The delay time (*Time*) can be synchronized with the BPM Counter. A simple delay (**Simple**) and the **3-Pong Delay**, which spreads the delays across the whole stereo image, are available.

**ECHO** is similar to the delay. The only difference is that the delayed signal is repeated several times. Use **Feedback** to specify the number of times that the delay is to be repeated. **Fade** determines if the echo is to fade out (On) or not (Off) when the effect is turned off.

1/4 TIME	2/4 MODE	3/4 FDBK	4/4 FADE	
DELAY				
10 ... 5930 ms	Simple 3Pong	-	-	Dry/Wet Mix
ECHO				
10 ... 5930 ms	Simple 3Pong	0 - 100%	On/Off	Dry/Wet Mix

Tab. 4.2: Effect parameters for Delay and Echo

### PITCHER, BITCRUSHER:

PITCHER changes the pitch of the music without changing the tempo. **Shift** adjusts the pitch.

BITCRUSHER simulates a decrease in the digital resolution. From soft lo-fi settings to toy sounds, everything is possible.

1/1	
PITCH	
Shift: -100 ... +100%	-
BITCRUSHER	
Depth: 0 ... 100%	Dry/Wet Mix

Tab. 4.3: Effect parameters for Pitch and Bitcrusher

### REVERB:

**REVERB** is a reverberation effect. Eight different reverb room simulations are available. When **Fade** is activated, the reverberation decays and is not truncated in case the effect is turned off.

Ambient is a very short reverb which lets you virtually hear the walls of the room.

Box delivers a spatial impression without long reflections.

Cathedral: The long and dense reverb of a big cathedral, ideal for slow tracks.

Cavern: An intensive, high-frequency-dominant reverb based on a cave with rocky walls.

Chamber produces the short reverb of a small room.

Chorus: A thick, warm reverberation which is shorter than that of Cathedral.

Concert simulates the well-defined reverb of a big concert hall.

Echo: A thick, short reverb with a longer pre-delay.

1/4 MODE	2/4 FADE	
Ambient, Box, Cathedral, Cavern, Chamber, Chorus, Concert, Echo	On/Off	Dry/Wet Mix

Tab. 4.4: Effect parameters for Reverb

### FILTER:

**FILTER** is an effect which is typically associated with synthesizer music. Three types of filters are available: **Band Pass**, **Low Pass** and **High Pass**. **Resonance** is used to increase the level of the filter frequency which makes the effect sound more intensive. In **LFO Mode**, the filter frequency is controlled by an **LFO**. **Manual Mode** lets you control the filter frequency with the **DEPTH** knob [44].

1/4 FILTER	2/4 RESO	3/4 MODE	4/4 LFO
FILTER			
Lowpass Bandpass Highpass	0 ... 100%	LFO	LFO Speed 
		Manual	Frequency 

Tab. 4.5: Effect parameters for Filter

### 4.1.5 Editing effects

As already mentioned in the previous chapter, each effect has up to five parameters (depending on the effect type) with which you can adjust the effect. In each case it is possible to adjust one parameter by using the **BEAT** push buttons. In most cases, this is the BPM-synchronized parameter.

#### Effect parameters:

- 1) Press the **PARAMETER** push button [47] to select a parameter. This only works when the effect is deactivated (the **FX ON** push button does not flash).
- 2) Alternatively, press the **PARAMETER** knob [45] to select a parameter.
- 3) Change the parameter value by turning the **PARAMETER** knob [45].
- 4) To switch to the next parameter, press **PARAMETER** [45] or [47] again.

#### Dry / Wet mix:

- ▲ Turn the **MIX** knob [44] slowly to the right to mix the effect (Wet) to the original signal (Dry).

### 4.1.6 BPM-synchronized effect parameters

Some of the effect sound especially interesting when time-related parameters respond to the rhythm of the music. The DDM4000 supports editable, BPM-synchronized parameters.

#### Editing BPM-synchronized parameters:

- 1) Make sure that the **BPM Counter** calculates the correct value (if applicable, enter manually with **TAP**, see Chapter 4.2).
- 2) Change the parameter step-by-step with the **BEAT** push buttons [49]. The selected value appears on the display.

#### DELAY, ECHO:

For the delay and echo effect, you can edit the delay time in musical units. The number of beats is displayed:

Beat	1/8	1/4	1/3	1/2	3/4	1/1	2/1	3/1	4/1	8/1
Note										

Fig. 4.3: Beats and note values for delay and echo

A rhythmical representation of the whole looks like this (showing a selection of several beats):

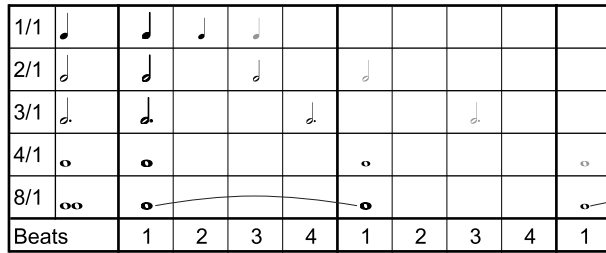
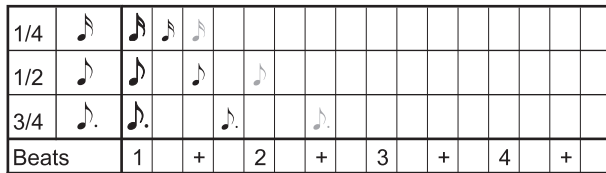

Fig. 4.4: Rhythmically represented delay parameter

### FLANGER, PHASER, PAN, FILTER:

For the filter effect, the BPM synchronization is only possible in LFO Mode. You can adjust the speed of the modulation (LFO speed). The values 1 – 32 correspond to the number of beats that are needed for one oscillation period:

Beat	1	2	3	4	6	8	12	16	24	32
Note	♪	♪	♪	♪	♪	♪	♪	♪	♪	♪
					2 Bars	3 Bars	4 Bars	6 Bars	8 Bars	

Fig. 4.5: Beats and note values for modulation effects

The following picture results from the musical context:

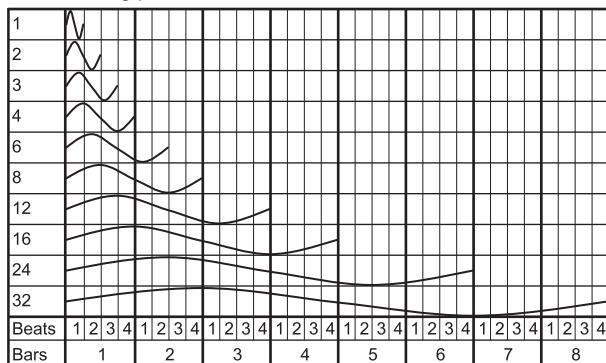

Fig. 4.6: LFO parameter, represented in beats and bars

### 4.1.7 FX Setup

FX Setup lets you specify the crossover frequencies between the individual bands of the EFFECT/BAND push buttons [46] – [48] (Kill function on the effect path, see Chapter 4.1.2). This is individually done for both effect devices.

XOVER FX1		XOVER FX2	
FX1LOW	FX1HIGH	FX2LOW	FX2HIGH
200Hz	3000Hz	150Hz	4000Hz

**CROSSOVER SETUP**

Adjustable parameters:

- FX1 LOW / FX2 LOW: Crossover frequency between LOW and MID.
- FX1 HIGH / FX2 HIGH: Crossover frequency between MID and HIGH.

- Press the left or right PARAMETER knob [45] to select the parameter for FX1 and FX2.
- Turn the left or right PARAMETER knob to change the value of the selected value.

### 4.2 BPM Counter

PAN		FX1 MUSIC	MIDI CLOCK	FX2 MUSIC	FLANGER
1/2 LFO	1.175s	102.1	2.3s	104.0	1.5 LFO
	BPM AUTO	MIDI BPM	STOP	BPM AUTO	1.159s
LO MID HI	◀ 1/4 ▶	1/2 1 2 3 ▶	FX1 ADJUST FX2	◀ 1/4 1/2 1 2 3 ▶	LO MID HI

The Auto BPM Counter is automatically able to convert the tempo of the track being played into BPM (Beats Per Minute). The detected BPM values are the basis for all time-related effect parameters and for the recording duration of the sampler. The BPM can be detected in two different ways: manually and automatically. In both cases, the current BPM is shown in Section B of the display.

#### Automatically detecting beats with AUTO BPM:

The BPM Counter detects the tempo of the signal source assigned to the Effect section. The signal source is shown in the BPM section of the display. (Assigning the signal source to the BPM/Effect section is described in Chapter 4.1.1.)

- Make sure that "Auto BPM" is activated. When active, the AUTO BPM push button [50] shines yellow and the BPM indicator flashes on the display.

**Should Tap Mode be active (AUTO BPM push button shines blue), press the AUTO BPM push button longer than one second to activate Auto BPM.**

- Now the BPM Counter determines the BPM value of the played signal. It is constantly brought up to date to be able to respond immediately to any tempo changes.

#### Manually detecting beats with TAP:

- Make sure that Tap Mode is activated. When active, the AUTO BPM/TAP push button [50] shines blue and the BPM indicator shows "Manual."

- Tap the TAP push button [50] (at least 2x) in the rhythm of the music, which results in a constant BPM value. Here's a tip: while tapping, listen in on the signal using the headphones.

**Should Auto BPM be active (AUTO BPM push button shines yellow), go to Step 2. When tapping the tempo, Manual Mode is automatically activated.**

- The BPM value can always be readjusted by tapping over and over again.

**The Auto BPM is always active when the device is turned on.**

**Without a music signal (or one which is too quiet), the BPM value flashes on the display. In addition, the message "Low Level" appears on the display. The BPM value also flashes when the beat cannot be clearly identified (message "Uncertain").**

## 4.3 MIDI Clock

The MIDI Clock is used as a time reference for the Bounce function. In addition, the MIDI Clock is given out at the MIDI output. This allows you to synchronize external devices, which are able to receive MIDI Clock (such as drum machines and grooveboxes) with the DDM4000.

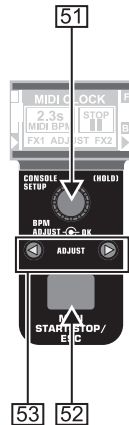

Fig. 4.7: BPM section

▲ Press the push button **52** to start and stop the MIDI Clock. You can adjust the tempo of the MIDI Clock. Alternatively, the MIDI Clock can also be synchronized with one of the two BPM Counters:

### MIDI BPM:

When in MIDI BPM Mode, “MIDI BPM” appears in the middle of the display below the BPM indicator of the MIDI Clock. Adjust the tempo by turning the CONSOLE SETUP knob **51**. It is possible to make bigger value jumps by pressing and simultaneously turning the knob.

### FX1/FX2 BPM:

To transmit the detected tempo of the BPM Counter to the MIDI Clock, press one of the ADJUST push buttons **53**. By pressing the left BEAT push button, the MIDI Clock adopts the tempo of the left BPM Counter. By pressing the right BEAT push button, the MIDI Clock adopts the tempo of the right BPM Counter. The assignment is indicated by displaying “FX1 BPM” or “FX2 BPM.”

Cancel the assignment by turning the CONSOLE SETUP knob to specify your own tempo.

The tempo of the MIDI BPM can also be transmitted to the BPM Counter. Hold the left or right ADJUST push button **53** (or both at the same time) while selecting the tempo with the CONSOLE SETUP knob **51**. This function is useful when assigning effects to a channel which is configured as MIDI controller so that the Auto BPM function does not work.

## 5. Sampler

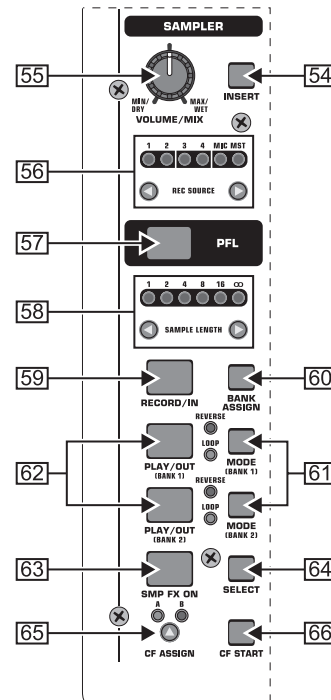
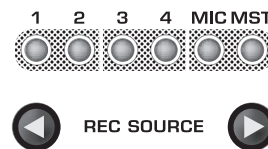

Fig. 5.1: Sampler section

A sampler is a device used to record and play back audio signals. The DDM4000's sampler lets you record two tracks which then can be played back. These tracks are single short sequences, vocal phrases, rhythmic loops or even longer song passages. Any audio signal fed to the mixer can be used as signal source, usually found on the stereo channels, the Microphone channel and the stereo sum. The maximum recording duration is 32 seconds. The samples can be played back in various ways (as infinite loop/loop, one time, forward, reverse).

### 5.1 Recording samples

- 1) Select a signal source with the REC SOURCE push buttons **56**. The signal source is indicated above the REC SOURCE LEDs:



#### Signal sources:

- 1, 2, 3, 4: Stereo channel 1, 2, 3 or 4
- MIC: Microphone channel
- MST: Master (stereo sum)

- 2) Use the SAMPLE LENGTH push buttons **58** to specify the recording duration you want. The length ranges between 1 and 16 beats or “∞” (infinite recording).

👉 **The actual recording time depends either on the detected BPM tempo or the MIDI Clock. The Sampler synchronizes with the BPM Counter provided that the BPM Counter is assigned to Channel 1, Channel 2 or Master. When this is not the case, the Sampler is synchronized with the MIDI Clock.**

- 3) Use BANK ASSIGN **60** to select the memory bank. The MODE push button **61** of the selected bank lights up yellow to indicate its readiness to record.
- 4) Start the recording by using the RECORD/IN push button **59**.

# DIGITAL PRO MIXER DDM4000

- 5) The recording stops after the number of beats specified beforehand.
- 6) Alternatively, stop the infinite recording ( $\infty$ ) by pressing the PLAY/OUT push button [45] or by pressing the REC push button again.

 **The recording duration of infinite recording ( $\infty$ ) is specified by pressing the RECORD/IN push button [59] and the PLAY/OUT push button [62]. In case Loop Mode is activated at the same time, the sampler immediately switches to playback by pressing the PLAY/OUT push button.**

## Memory:

The maximum recording time is 32 seconds for both banks. The recording stops when the memory is full.

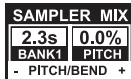

The length of a sample and the time left are shown on the Sampler Mix display.

## 5.2 Playing back samples

- 1) Turn the VOLUME/MIX knob [55] to the center position.
- 2) Press the PLAY push button to start playback.
- 3) Press PLAY a second time to stop playback.

### 5.2.1 Insert function

The sample playback is carried out in Mix Mode or Insert Mode. In both cases the sample is played back on the channel selected with REC SOURCE push buttons [56]. This can also be the stereo sum. When playing back in **Mix Mode**, the sample is mixed to the specific channel or is routed to the crossfader. When playing back the sample in **Insert Mode**, the sample is crossfaded to the assigned channel.

- ▲ When playing back in **Mix Mode**, the INSERT push button [54] is not allowed to be pressed (push-button LED is off). The VOLUME/MIX knob [55] is used as a channel fader (volume) with which the sampler signal is mixed to the signal source. The sampler signal is assigned to the crossfader by pressing the CF ASSIGN push button [65]
- ▲ Press the INSERT push button [54] to play back the sample in **Insert Mode**. The VOLUME/MIX knob [55] can now be used as crossfading control (Mix). Turn the knob completely to the right to hear only the sample during playback. When turning the knob to the left, the sample fades into the signal source of the selected channel.

 **Assigning the crossfader to the Sampler is only possible in Mix Mode. As soon as the CF ASSIGN push button [65] is pressed, the Insert function is automatically deactivated.**

### 5.2.2 Reverse and Loop playback

Use the MODE push buttons [61] for Bank 1/2 to determine the type of playback. Select the playback mode for each bank:

#### REVERSE:

- 1) Tap the MODE push button to switch to Reverse Mode. The REVERSE LED lights up. By pressing PLAY, the sample is played back in the reverse direction.
- 2) Tap the MODE push button again. The REVERSE LED goes out. The sample is played back in the forward direction.

#### LOOP (infinite loop):

- 1) Press the MODE push button for approximately 1 second to deactivate Loop Mode. The LOOP LED goes out. The sample is played back as long the PLAY push button is pressed. This type of playback is ideal for short inserts/samples.
- 2) Press the MODE push button again for approximately 1 second to activate Loop Mode. The LOOP LED lights up. The sample is played back as infinite loop by pressing PLAY.

### 5.2.3 Crossfader start

The Crossfader Start function lets you start the Sampler playback with the crossfader. To be able to use this function, the Sampler needs to be assigned to the crossfader.

- 1) Press the CF ASSIGN push button to route the Sampler to one side of the crossfader (A or B).
- 2) Press CF START to activate Crossfader Start.
- 3) Press the BANK ASSIGN push button to select the bank that is to be triggered by the crossfader.

Playback starts as soon as you move the crossfader to the side assigned to the Sampler.

### 5.2.4 Pitch Bend

The Pitch Bend function lets you change the speed of the sampler playback so that it can be aligned to the tracks being played. There are two options:

- 1) Turn the BPM Adjust knob to permanently change the playback speed of the sampler. Turn the knob to the right to speed up the tempo and turn the knob to the left to slow down the tempo.
- 2) The ADJUST push buttons correspond to "Bend +" and "Bend -." Pressing one of these push buttons changes the speed for a short while, in order for you to easily match the beat of the playing track.

## 5.3 Sampler effect

The sampler features a brake effect which simulates the braking of the rotating platter until it comes to a halt. The length of the brakes are available as 1-beat-, 4-beat- und 8-beat brakes.

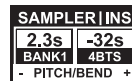

- 1) Press the BANK ASSIGN push button to select the memory bank that is to be processed with the effect.
- 2) Select the length of the brake by continuously pressing the SELECT push button [64]. This is shown on the display.
- 3) Press the SMP FX ON push button [63] to activate the effect. The push button flashes.

When the sampler comes to an end (SMP FX ON push button and PLAY/OUT push button of the selected bank flash), the sampler-effect needs to be deactivated by pressing SMP FX ON again in order to restart playback.

- 4) Press the SMP FX ON push button to restart playback.

## 6. Further settings

### 6.1 Loading factory settings

- 1) Press the LOAD push button [35]. The display switches to "User Setup". The LOAD push button lights up.
- 2) Select the factory preset by turning and pressing the left PARAMETER knob [45].
- 3) Press the left PARAMETER knob to confirm the selection.
- 4) Press the LOAD push button [35] or the ESC push button [52] to exit User Setup.

### 6.2 Output Setup

- 1) Press the CONSOLE SETUP knob [51] for approximately 2 seconds.
- 2) Select "Output Setup" by turning and pressing the CONSOLE SETUP knob. Output Setup appears on the display:

OUT B	OUTPUT SETUP	MODE	SUB-OUT		TAPE/ S/PDIF
MONO		FULL-FREQ	FREQ	GAIN	GAIN
OFF		CROSSOVER	55Hz	-3.0dB	-6.0dB
ON					

In Output Setup, you make the following settings:

#### Mono:

Use this function to switch the OUT B outputs [74] to mono.

- 1) Turn the left PARAMETER knob [45] to select OFF or ON.
- 2) Press the left PARAMETER knob to confirm.

#### MODE:

You can use Output A [73] together with the Subwoofer output, in which case the bass frequencies are separated from the Main output (crossover function).

**FULL-FREQ:** MAIN OUT A [73] emits the entire frequency spectrum (including the bass signal). The Subwoofer output gives out the subwoofer signal.

**CROSSOVER:** The Subwoofer output gives out the subwoofer signal. MAIN OUT A emits frequencies that are above the crossover frequency.

- 1) Turn the CONSOLE SETUP knob [51] to select the mode (FULL-FREQ, CROSSOVER).
- 2) Press the CONSOLE SETUP knob to confirm.

#### SUB OUT:

The following are used to adjust the crossover frequency and output level of the subwoofer output.

**FREQ:** Crossover frequency between SUB OUT and MAIN OUT

**GAIN:** Output level of SUB OUT

#### TAPE / S/PDIF:

The levels of both Tape and S/PDIF outputs can be adjusted individually.

- 1) Press the right PARAMETER knob to select the parameter (FREQ, GAIN or TAPE/ S/PDIF GAIN).
- 2) Turn the PARAMETER knob to change the value.
- 3) Press the ESC push button to exit Output Setup.

### 6.3 Adjusting display contrast

- 1) Press the LOAD push button [35]. User Setup appears on the display.
- 2) Turn the right PARAMETER knob [45] to change the contrast.
- 3) Press the LOAD push button to exit User Setup.

## 7. The DDM4000 as MIDI controller

The DDM4000 can be used to control DJ or sequencer software applications by converting individual mixer sections on the mixer to MIDI controllers and assigning these to defined software functions. The MIDI interface [76] is used to transmit the data. To connect to the mixer, the computer requires a MIDI interface, which can be purchased as USB alternative for a very reasonable price.

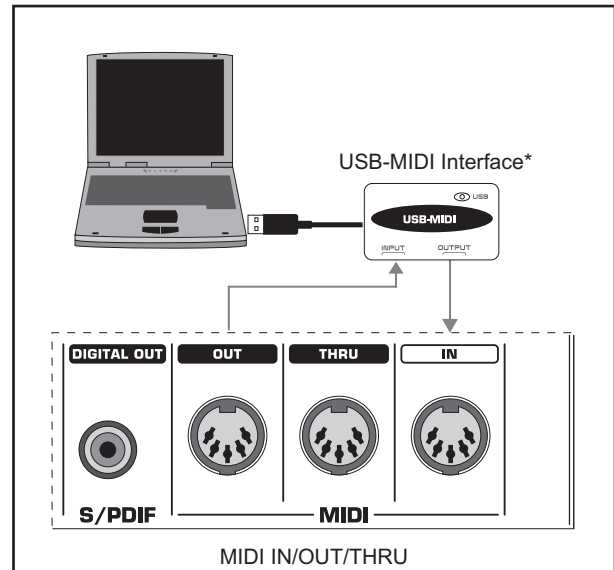

\* not included

Fig. 7.1: Connecting the DDM4000 to a computer

### 7.1 MIDI protocol

The MIDI format is used for the data transmission. Knobs and faders send Control Change messages (CC), and push buttons send Note messages (see Table 10.2). Access the software settings to assign mixer controls to software functions. Most software applications offer a learn function to make the assigning even easier.

The MIDI transmission also works in the opposite direction. Basically, it is confined to controlling the LEDs, so that a switching status in the software application can also be shown on the DDM4000. In this case the DDM4000 receives CC messages from the computer. Each LED of the DDM4000 is assigned to a CC number (see Table 10.3). Sending the value 0 makes the LED go out, but sending the value 1 (or any higher value) turns on the LED.

### 7.2 Common MIDI settings

The MIDI settings are made on the MIDI Setup page.

- 1) Press the CONSOLE SETUP knob [51] for approximately 2 seconds.
- 2) Select "MIDI Settings" by turning and pressing the CONSOLE SETUP knob. The MIDI Setup page appears on the display:

PUSH TO DUMP MIDI DATA	MIDI SETUP	MIDI SET	MIDI SET * AUDIO
CHANNEL 1		<input type="checkbox"/> MIC	<input type="checkbox"/> CH-1
		<input type="checkbox"/> SAMPLER	<input type="checkbox"/> CH-2
		<input type="checkbox"/> CROSSFADER	<input type="checkbox"/> CH-3
			<input type="checkbox"/> CH-4
			<input type="checkbox"/> MUTE

This page allows you to make the following settings:

- ▲ Adjusting the MIDI channel (7.2.1)
- ▲ Sending a MIDI dump (7.2.2)
- ▲ Configuring the Microphone channel, Sampler and crossfader as MIDI controller (7.3)
- ▲ Configuring stereo channels as MIDI controllers (7.4)
- 3) Press the ESC push button [52] to exit MIDI Setup.

**Save the settings you made in a user preset (see Chapter 3.5.2 "Storing user settings") in case you want the settings to be active the next time you switch on the device.**

# DIGITAL PRO MIXER DDM4000

## 7.2.1 Setting the MIDI channel

The following describe how to specify the MIDI channel on which the DDM4000 is to send controller data. The receiving device needs to be set to the same channel.

- 1) Open MIDI Setup (see Chapter 7.2).
- 2) Turn the left PARAMETER knob [45] to select the MIDI channel.
- 3) Press the ESC push button [52] to exit MIDI Setup.

## 7.2.2 Sending a MIDI dump

A MIDI dump sends the values of current controller positions. As a result, the DDM4000's settings are aligned with the connected computer.

- 1) Open MIDI Setup (see Chapter 7.2).
- 2) Press the left PARAMETER knob [45] to start the MIDI dump. After sending the dump, the DDM4000 returns to MIDI Setup.
- 3) Press the ESC push button [52] to exit MIDI Setup.

## 7.3 Configuring Microphone channel, Sampler and crossfader as MIDI controller

The Microphone channel, the Sampler and the crossfader section can individually be converted to MIDI controllers.

- 1) Open MIDI Setup (see Chapter 7.2).
- 2) Turn the CONSOLE SETUP knob [51] to select the mixer section (MIC, SAMPLER, CROSSFADER) you want to use.
- 3) Press the CONSOLE SETUP knob to confirm the selection. The LEDs of the selected section go out.
- 4) Press the ESC push button [52] to exit MIDI Setup.

### Particularities of the crossfader:

It is not possible to assign the stereo channels to the crossfader when the crossfader section is defined as controller. The Assign push buttons are inoperative. The routing behaves as if the crossfader is deactivated: the signals are directly fed to the mixer's sum. As for the Sampler, the CF Assign function and CF Start function are also inoperative. As usual, the routing of the Sampler signal is realized with the REC SOURCE push button.

## 7.4 Configuring stereo channels as MIDI controller

Using the channel fader [8], the EQ knobs [4] and the kill push buttons [5] and [6] generates MIDI data when one of the 4 stereo channels is configured as MIDI controller. The configured channel is still able to play back music, however, the equalizer, the channel fader and the CF Assign function are not active. In case an audio signal is being fed to the selected channel, it is routed to the mixer's sum without being processed and at full volume level. Simply mute the signal in case the audio function is not required.

- 1) Open MIDI Setup (see Chapter 7.2).
- 2) Turn the right PARAMETER knob [45] to select the stereo channel you want (and, if required, the Mute function).
- 3) Press the PARAMETER knob to confirm the selection. The push-button LEDs of the selected channel go out.

**Press the ESC push button [52] to exit MIDI Setup. Level jumps can occur when activating or deactivating the MIDI controller function in a stereo channel depending on the position of the equalizer and fader! Turn the OUTPUT knob in the Main and Phones section completely to the left before activating this function.**

## 8. Installation

The inputs and outputs of the BEHRINGER DDM4000 are RCA connectors. The Headphone output is a stereo jack. The Microphone inputs are XLR connectors.

**Make sure that only competent people install your DDM4000. They must be sufficiently earthed during and after the installation process. Otherwise, electrostatic discharges may negatively affect the operating characteristics of your equipment.**

### Balanced use with XLR connectors

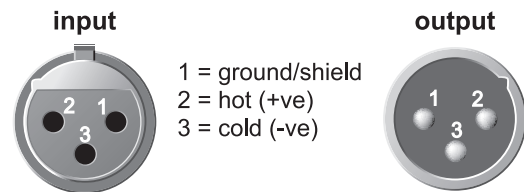

For unbalanced use, pin 1 and pin 3 have to be bridged

Fig. 8.1: XLR connector

### 1/4" TRS headphones connector

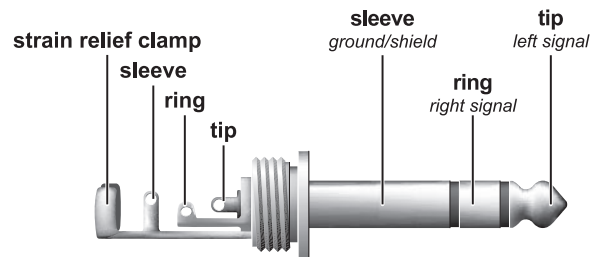

Fig. 8.2: 1/4" headphones connector

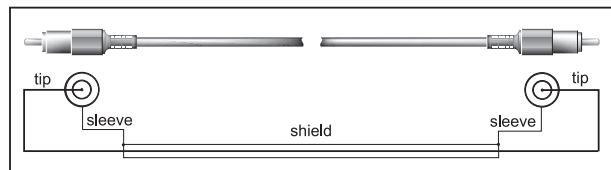

Fig. 8.3: RCA cable



9. Specifications

**AUDIO INPUTS**

**Mic 1/2 (XLR, electronically balanced)**

Max. input level -14 dBu  
 Input impedance 2 kΩ

**Phono (RCA)**

Max. input level -18 dBu  
 Input impedance 47 kΩ

**Line (RCA)**

Max. input level +30 dBu  
 Input impedance 15 kΩ

**AUDIO OUTPUTS**

**OUT A (XLR, balanced)**

Max. output level +21 dBu  
 Output impedance 200 Ω

**OUT A / OUT B / TAPE (RCA)**

Max. output level +21 dBu  
 Output impedance 100 Ω

**Phones Out**

max. 260 mW @ 100 Ω / 1 % THD

**S/PDIF**

(coaxial, 16 bit, 44.1 kHz)

**EQUALIZER**

Stereo Low -∞ dB/+12 dB  
 Stereo Mid -∞ dB/+12 dB  
 Stereo High -∞ dB/+12 dB

Mic Low -12 dB/+12 dB, Shelving  
 Mic Mid -12 dB/+12 dB, Peak  
 Mic High -12 dB/+12 dB, Shelving

**DIGITAL EFFECTS PROCESSOR**

DSP 2x Analog Devices Black Fin  
 AD/DA converter 24-bit Sigma-Delta/128-times oversampling/Cirrus  
 Sampling rate 44.1 kHz  
 LCD display 320 x 40 pixel

**MIDI interface**

5-pin DIN jacks In/Out/Thru

**SYSTEM SPECIFICATIONS**

**Frequency response**

Mic 25 Hz – 20 kHz, +0/-3 dB  
 Phono 20 Hz – 20 kHz, +0/-3 dB  
 Line 20 Hz – 20 kHz, +0/-3 dB

**Signal-to-noise ratio**

Mic > 87 dB  
 Phono > 83 dB  
 Line > 102 dB  
 Distortion (THD) < 0,009 % (Line – OUT A)  
 Crosstalk < -80 dB / 1 kHz (Line)

**POWER SUPPLY**

**Mains voltage / fuse**

100 – 240 V~, 50/60 Hz T 1 A H 250 V

**Power consumption**

max. 20 W

**Mains connector**

standard IEC receptacle

**DIMENSIONS/WEIGHT**

Dimensions (H x W x D) approx. 4 1/3" x 12 3/5" x 15 1/2"  
 (110 mm x 320 mm x 392 mm)  
 Weight approx. 9.3 lbs. (4.2 kg)

BEHRINGER is constantly striving to maintain the highest professional standards. As a result of these efforts, modifications may be made from time to time to existing products without prior notice. Specifications and appearance may differ from those listed or illustrated.



## 10. Appendix

	PARAM	PARAM	PARAM	PARAM	PARAM	MIX DEPTH
	Parameter 1	Parameter 2	Parameter 3	Parameter 4	Parameter 5	Mix
FLANGER	LFO Speed*	Feedback	Depth	Phase	Fade	Dry/Wet Mix
PHASER	LFO Speed*	Depth	Fade	-	-	Dry/Wet Mix
DELAY	Time*	Mode: Simple 3Pong	-	-	-	Dry/Wet Mix
ECHO	Time*	Mode: Simple 3Pong	Feedback	Fade	-	Dry/Wet Mix
PITCH	Shift	-	-	-	-	Dry/Wet Mix
BITCRUSHER	Depth	-	-	-	-	Dry/Wet Mix
REVERB	Mode: Ambient, Box, Cathedral, Cavern, Chamber, Chorus, Concert, Echo	Fade	-	-	-	Dry/Wet Mix
PAN	LFO Speed*	Depth	-	-	-	Dry/Wet Mix
FILTER	Filter: Lowpass Bandpass Highpass	Resonance	LFO:	LFO Speed* 	-	-
			Manual:		-	

\*These parameters can be synchronized with BPM

Fig. 10.1: Overview of effect parameters

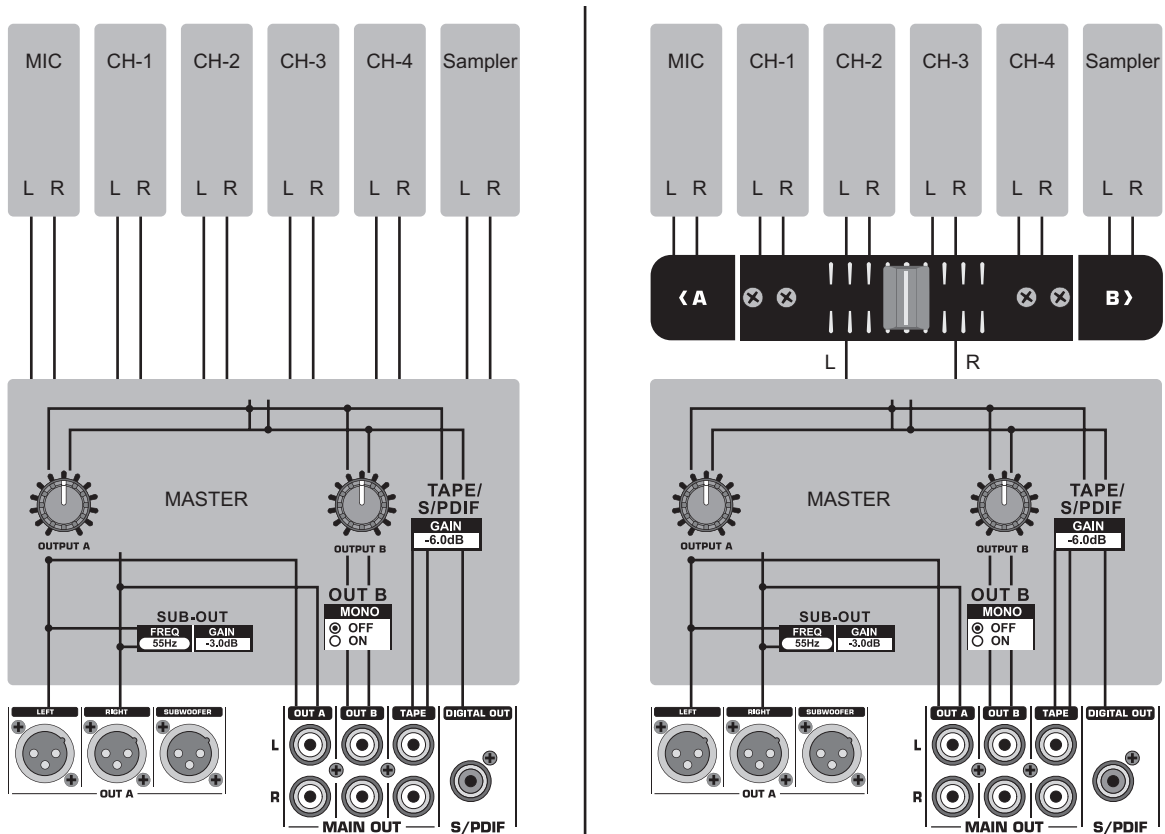

Fig. 10.2: Mixer routings

## 11. Warranty

### § 1 Other warranty rights and national law

1. This warranty does not exclude or limit the buyer's statutory rights provided by national law, in particular, any such rights against the seller that arise from a legally effective purchase contract.
2. The warranty regulations mentioned herein are applicable unless they constitute an infringement of national warranty law.

### § 2 Online registration

Please do remember to register your new BEHRINGER equipment right after your purchase by visiting <http://www.behringer.com> and kindly read the terms and conditions of our warranty carefully.

Registering your purchase and equipment with us helps us process your repair claims quicker and more efficiently.

*Thank you for your cooperation!*

### § 3 Warranty

1. BEHRINGER (BEHRINGER International GmbH including all BEHRINGER subsidiaries, except BEHRINGER Japan) warrants the mechanical and electronic components of this product to be free of defects in material and workmanship for a period of one (1) year\* from the original date of purchase, in accordance with the warranty regulations described below. If the product shows any defects within the specified warranty period that are not excluded from this warranty as described under § 5, BEHRINGER shall, at its discretion, either replace the product by providing a new or reconditioned product or repair the product using suitable new or reconditioned parts. In the case that other parts are used which constitute an improvement, BEHRINGER may, at its discretion, charge the customer for the additional cost of these parts. In case BEHRINGER decides to replace the product, this warranty shall apply to the replacement product for the remaining initial warranty period, i.e. one year\* from the date of purchase of the initial product.
2. If the warranty claim proves to be justified, the product will be returned to the user freight prepaid.
3. Warranty claims other than those indicated above are expressly excluded.

### § 4 Return authorization number

1. To obtain warranty service, the buyer (or his authorized dealer) must call BEHRINGER during normal business hours BEFORE returning the product. All inquiries must be accompanied by a description of the problem. The buyer or his authorized dealer will receive a return authorization number.
2. Subsequently, the product must be returned in its original shipping carton, together with the return authorization number. The return shipment address will be indicated by BEHRINGER.
3. Shipments without freight prepaid will not be accepted.

### § 5 Warranty regulations

1. Warranty services will be furnished only if the product is accompanied by a copy of the original retail dealer's invoice. Any product deemed eligible for repair or replacement under the terms of this warranty will be repaired or replaced.
2. If the product needs to be modified or adapted in order to comply with applicable technical or safety standards on a national or local level, in any country which is not the country for which the product was originally developed and manufactured, this modification/adaptation shall not be considered a defect in materials or workmanship. The warranty does not cover any such modification/adaptation, irrespective of whether it was carried out properly or not. Under the terms of this warranty, BEHRINGER shall not be held responsible for any cost resulting from such a modification/adaptation.
3. Free inspections and maintenance/repair work are expressly

excluded from this warranty, in particular, if caused by improper handling of the product by the user. This also applies to defects caused by normal wear and tear, in particular, of faders, crossfaders, potentiometers, keys/buttons, tubes, guitar strings, illuminants and similar parts.

4. Damage/defects caused by the following conditions are not covered by this warranty:
  - ▲ improper handling, neglect or failure to operate the unit in compliance with the instructions given in BEHRINGER user or service manuals.
  - ▲ connection or operation of the unit in any way that does not comply with the technical or safety regulations applicable in the country where the product is used.
  - ▲ damage/defects caused by force majeure or any other condition that is beyond the control of BEHRINGER.
5. Any repair or opening of the unit carried out by unauthorized personnel (user included) will void the warranty.
6. If an inspection of the product by BEHRINGER shows that the defect in question is not covered by the warranty, the inspection costs are payable by the customer.
7. Products which do not meet the terms of this warranty will be repaired exclusively at the buyer's expense. BEHRINGER will inform the buyer of any such circumstance. If the buyer fails to submit a written repair order within 6 weeks after notification, BEHRINGER will return the unit. Costs for freight and packing will be invoiced separately C.O.D. When the buyer has sent in a written repair order such costs will also be invoiced separately.

### § 6 Warranty transferability

This warranty is extended exclusively to the original buyer (customer of retail dealer) and is not transferable to anyone who may subsequently purchase this product.

No other person (retail dealer, etc.) shall be entitled to give any warranty promise on behalf of BEHRINGER.

### § 7 Claim for damages

Failure of BEHRINGER to provide proper warranty service shall not entitle the buyer to claim (consequential) damages.

In no event shall the liability of BEHRINGER exceed the invoiced value of the product.

\* Customers in the European Union please contact BEHRINGER Germany Support for further details.

Technical specifications and appearance are subject to change without notice. The information contained herein is correct at the time of printing. All trademarks (except BEHRINGER, the BEHRINGER logo, JUST LISTEN and DIGITAL PRO MIXER) mentioned belong to their respective owners and are not affiliated with BEHRINGER. BEHRINGER accepts no liability for any loss which may be suffered by any person who relies either wholly or in part upon any description, photograph or statement contained herein. Colors and specifications may vary slightly from product. Products are sold through our authorized dealers only. Distributors and dealers are not agents of BEHRINGER and have absolutely no authority to bind BEHRINGER by any express or implied undertaking or representation. No part of this manual may be reproduced or transmitted in any form or by any means, electronic or mechanical, including photocopying and recording of any kind, for any purpose, without the express written permission of BEHRINGER International GmbH. Mac is a trademark of Apple Computer, Inc., registered in the U.S. and other countries. Windows is a registered trademark of Microsoft Corporation in the United States and other countries. ALL RIGHTS RESERVED.

(c) 2007 BEHRINGER International GmbH.  
BEHRINGER International GmbH, Hanns-Martin-Schleyer-Str. 36-38, 47877 Willich-Muenchheide II, Germany.  
Tel. +49 2154 9206 0, Fax +49 2154 9206 4903