

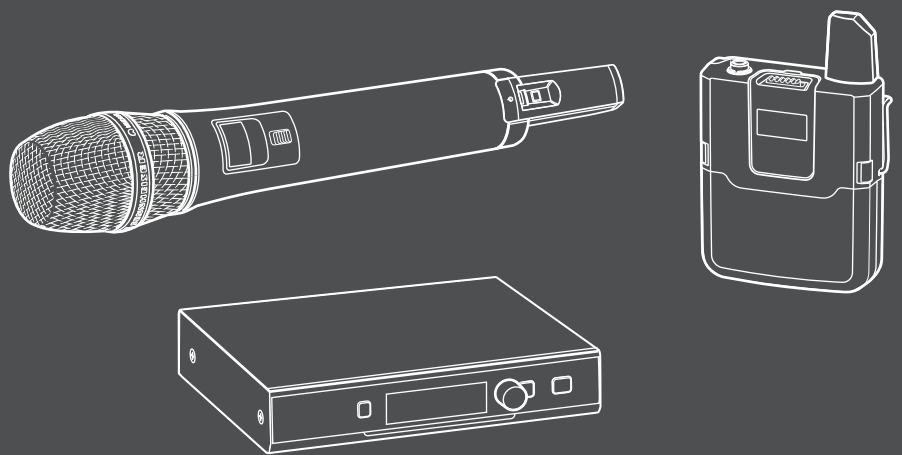









evolution wireless D1

System Manual



Contents

	Important safety instructions	2
	Optimum sound the easy way	5
	Package contents	6
	Product overviews	7
	EM D1 rack receiver	7
	SKM D1, SKM-S D1 and SK D1 transmitters	11
	Displays of the transmitters	13
	Optional accessories for the transmitters	13
	ME 3-II headset microphone	14
	ME 2-2 clip-on microphone	14
	Putting the products into operation	15
	Putting the receiver into operation	16
	Putting the bodypack transmitter into operation	22
	Preparing the headset microphone for use	23
	Attaching the clip-on microphone to clothing	23
	Putting the handheld transmitter into operation	24
	Recharging the accupack	25
	Using the products	26
	Switching the devices on or off	26
	Checking the charge status of the batteries or accupacks	27
	Checking the RF signal level	27
	Muting the bodypack transmitter or the SKM-S D1 handheld transmitter	28
	Pairing a receiver with a transmitter	28
	Identifying paired devices	29
	Using the devices in multi-channel operation	29
	Switching between the standard display and the extended standard display 29	
	Using the operating menu of the receiver	30
	Controlling, monitoring or updating devices via the network	38
	Cleaning and maintaining the products	42
	If a problem occurs	44
	Troubleshooting	44
	Reacting to messages displayed on the display panel	45
	Specifications	46
	Licenses	51
	Accessories	54
	Manufacturer Declarations	56



Important safety instructions



1. Read these safety instructions and the instruction manuals of the products.
2. Keep these safety instructions and the instruction manuals of the products. Always include these safety instructions and the instruction manuals when passing the products on to third parties.
3. Heed all warnings.
4. Follow all instructions.
5. Do not use the products near water.
6. Only clean the products when they are not connected to the power supply system. Use a dry cloth for cleaning.
7. Do not block any ventilation openings. Install the products in accordance with the instructions given in the instruction manuals.
8. Do not operate near any heat sources such as radiators, stoves, or other apparatus (including amplifiers) that produce heat.
9. Only operate the products from the types of power source specified in the chapter "Specifications" on page 46 and indicated on the power supply unit.
10. Only use the supplied power supply units.
11. Unplug the power supply units from the wall socket,
 - to completely disconnect the products from the power supply system,
 - during lightning storms or
 - when not using the products for long periods of time.
12. Always ensure that the power supply units are
 - in a safe operating condition and easily accessible,
 - properly plugged into the wall socket,
 - only operated within the permissible temperature range,
 - not covered or exposed to direct sunlight for longer periods of time in order to prevent heat accumulation.
13. Protect the power cords from being walked on or pinched, particularly at the points where they exit from wall sockets, power supply units and products.
14. Only use attachments, accessories or spare parts specified by Sennheiser
15. Only use the products with the carts, stands, tripods, brackets, or tables specified by Sennheiser, or sold with the products.
16. When a cart is used, use caution when moving the cart/product combination to avoid injury from tip-over.
17. When using the supplied device feet, do not place the products on delicate surfaces. Delicate surfaces can become discolored or stained when they come into contact with the plastic of the device feet.
18. Refer all servicing to qualified service personnel. Servicing is required when the products have been damaged in any way, liquid has been spilled or objects have fallen into the products, when the products has been exposed to rain or moisture, do not operate normally, or have been dropped.
19. **WARNING:** To reduce the risk of fire or electric shock, do not expose the products to rain or moisture
20. Do not expose the products to dripping or splashing. Ensure that no objects filled with liquids, such as vases, are placed on the products.





Risk of fire due to overloading

- ▶ Do not overload wall outlets and extension cables as this may result in fire and electric shock.

Safety instructions for antennas

- ▶ Use safety wires to protect the antennas against tipping/dropping.
The safety wires, rope terminations and coupling links must comply in their dimensioning and condition with the regulations and standards of the country in which they are used!

Safety instructions for lithium-ion rechargeable batteries



If abused or misused, the rechargeable batteries may leak. In extreme cases, they may even present a risk of

- explosion,
- fire development,
- heat generation,
- smoke or gas development.

Sennheiser does not accept any liability for damage arising from abuse or misuse.



- ▶ Keep away from children.



- ▶ Only charge rechargeable batteries with chargers recommended by Sennheiser.



- ▶ Observe correct polarity.



- ▶ Pack/store charged rechargeable batteries so that the terminals cannot contact each other – danger of shorting out/fire hazard.



- ▶ Do not expose to moisture.



- ▶ Switch rechargeable battery-powered products off after use.



- ▶ Only charge rechargeable batteries at ambient temperatures between 10 °C/50 °F and 40 °C/104 °F.



- ▶ When not using rechargeable batteries for extended periods of time, charge them regularly (about every three months).



- ▶ Do not mutilate or dismantle.



- ▶ Do not heat above 60 °C/140 °F, e.g. do not expose to sunlight or throw into a fire.



- ▶ Immediately remove rechargeable batteries from obviously defective products.



- ▶ Do not continue to use defective rechargeable batteries.



- ▶ Only use rechargeable batteries specified by Sennheiser.



- ▶ Dispose of rechargeable batteries at special collection points or return them to your specialist dealer.



- ▶ Store the products in a cool and dry place at room temperature (approx. 20 °C/68 °F).



- ▶ Remove the rechargeable batteries if the products will not be used for extended periods of time.

Intended use

The microphones, the transmitters, the receiver and the accessories of the Sennheiser evolution wireless D1 system can be combined with each other and have been designed for indoor use (e.g. in rehearsal rooms, studios, theaters and on stages).

In order that music and vocals are transmitted in the best possible quality, the products have to be connected, as described in this instruction manual, to a suitable mixing console or amplifier which, in turn, has to be connected to optimally positioned loudspeakers.

The products can be used for commercial purposes.

Intended use includes:

- having read and understood these safety instructions and the instruction manuals of the products
- using the products within the operating conditions and limitations described in these safety instructions and in the instruction manuals of the products.

It is considered improper use when the products are used for any application not named in the instruction manuals of the products.

Sennheiser does not accept liability for damage arising from abuse or misuse of the products and their accessories.



Optimum sound the easy way

The Sennheiser evolution wireless D1 series consists of high-quality state-of-the-art RF transmission systems with a high level of operational reliability and ease of use. The transmitters and the receiver permit wireless transmission with studio-quality sound.

Features of the evolution wireless D1 series:

- Digital transmission with an excellent transmission range and intelligent signal amplification
- Optimum sound due to preset sound profiles and audio effects:
 - low-cut filter
 - equalizer
 - automatic gain control
 - de-esser
- Quick and easy setup and operation due to automatic frequency management and automatic microphone sensitivity adjustment
- Low latency
- Extended dynamic range
- Secure and license-free transmission in the 2.4 GHz frequency band
- Automatic interference management provides optimum protection against sources of interference such as WiFi or Bluetooth
- Long battery life
- Centralized remote control, monitoring and firmware updating via the "Wireless System Remote" (WSR) app or the "Sennheiser D1 SL Updater" software
- Convenient access to help functions via QR codes



Package contents

Package contents	Vocal Sets				Lavalier Set	Headmic Set	Instrument Set
	ew D1-835-S	ew D1-845-S	ew D1-935	ew D1-945	ew D1-ME2	ew D1-ME3	ew D1-CI1
EM D1 rack receiver	1	1	1	1	1	1	1
SK D1 bodypack transmitter	–	–	–	–	1	1	1
ME 2-2 clip-on microphone	–	–	–	–	1	–	–
ME 3-II headset microphone	–	–	–	–	–	1	–
Handheld transmitter with mute switch and MMD 835-1 microphone head	1	–	–	–	–	–	–
Handheld transmitter with mute switch and MMD 845-1 microphone head	–	1	–	–	–	–	–
Handheld transmitter with MMD 935-1 microphone head	–	–	1	–	–	–	–
Handheld transmitter with MMD 945-1 microphone head	–	–	–	1	–	–	–
B 10 battery box	1	1	1	1	–	–	–
B 30 battery box	–	–	–	–	1	1	1
NT 12-4C ¹ or NT 2-3 ² power supply unit	1	1	1	1	1	1	1
CI 1 guitar cable	–	–	–	–	–	–	1
Transport case	1	1	1	1	1	1	1
AA size batteries (1,5 V)	2	2	2	2	2	2	2

¹ Country-specific versions of the NT 12-4C are available for Europe, the UK, and the USA.

² The NT 2-3 power supply unit is available for all other regions.



Product overviews

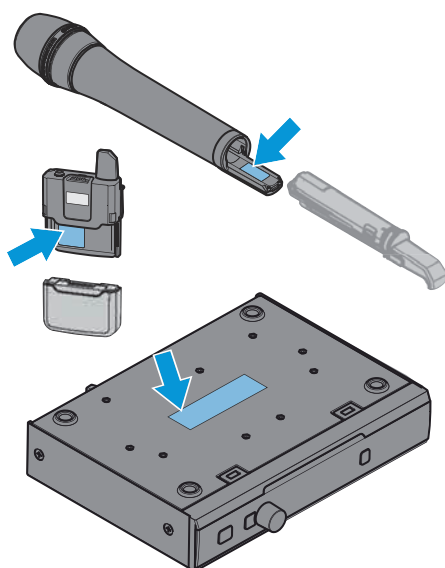

The transmitters and the receiver are available in different country variants:

- -H variants are available in Europe, the UK and all other countries in which the products are distributed
- -NH variants are available in the Americas, China and Australia
- -NH10 variants are available in Japan and South Korea

The country variant can be found on the packaging and on the type plate as shown on the left.

- ▶ Only use the country variant permitted for use at the venue.
- ▶ Do not combine devices of different country variants.

EM D1 rack receiver

Operating elements – front panel

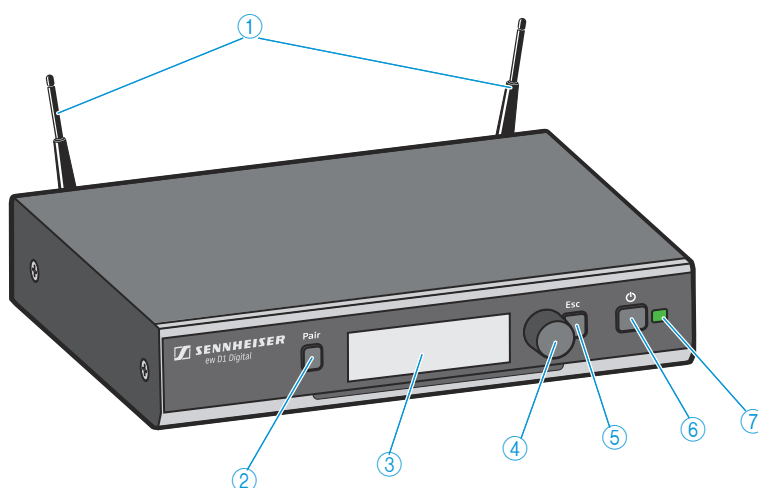

- ① 2G4 rod antennas
- ② PAIR button
- ③ Display panel
- ④ Jog dial
- ⑤ ESC button
- ⑥ STANDBY button

for connection to the R-SMA sockets at the rear of the receiver

Short-press to identify the paired transmitter (see page 29).
Long-press to change the pairing (see page 28).

For details, see page 9.

Turn to navigate through the menu, to change settings or to change from the standard display to the extended standard display.
Press to open the menu or to confirm the entry or selection.

Short-press to navigate to the next higher level in the menu or to exit a menu item without confirming new settings or entries.
Long-press to exit the menu and to return to the standard display.

Short-press to switch the receiver on.
Long-press to switch the receiver off.



- ⑦ Status LED ✱ lights up green: A radio link to the transmitter is established. The batteries of the received transmitter are sufficiently charged.

 - ✱ ✱ ✱ ✱... flashes green: The **PAIR** button has been short-pressed. Paired devices are being identified.

 - ✱ ✱ ✱ ✱... flashes alternately green and red: The **PAIR** button has been long-pressed. The receiver establishes a radio link to a transmitter whose **PAIR** button has also been long-pressed.

 - ✱ lights up yellow: The received transmitter has been muted with the **MUTE** switch. In addition, **Muted** is displayed on the display panel.

 - ✱ ✱ ✱ ✱... flashes red: The battery capacity of the received transmitter is only sufficient for approx. 30 minutes of operation.

 - ✱ lights up red: No radio link to a transmitter. In addition, the background of the display panel changes back and forth between light and dark and **No Link** appears on the display panel.

Operating elements – rear panel

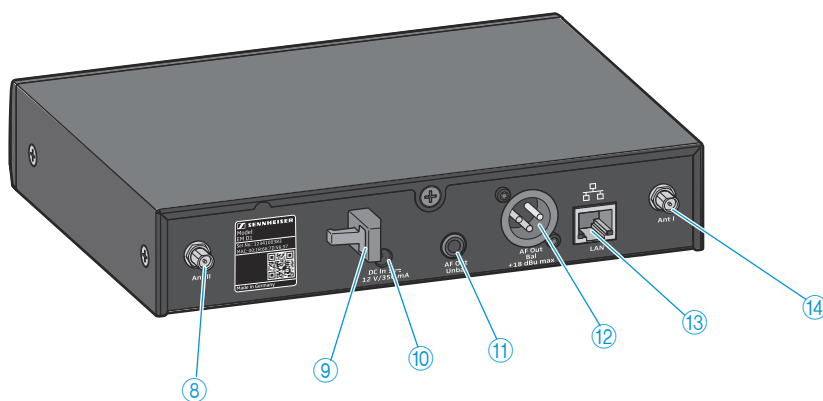

- ⑧ R-SMA socket **ANT II** Antenna input II for connecting a supplied 2G4 rod antenna (for details, see page 16)

- ⑨ Cable grip for the cable of the power supply unit

- ⑩ DC IN socket for connection of the power supply unit

- ⑪ 1/4" (6.3 mm) jack socket **AF OUT UNBAL** Unbalanced audio output for connection to the 1/4" (6.3 mm) jack input of the mixing console (for details, see page 20)

- ⑫ XLR-3 socket **AF OUT BAL** Balanced audio output for connection to the XLR-3 input of the mixing console (for details, see page 20)

- ⑬ Ethernet socket **LAN** for connecting to a network router or a switch (e.g. to control, monitor and update several receivers via a mobile device or a computer (for details, see page 20)

- ⑭ R-SMA socket **ANT I** Antenna input I for connecting a supplied 2G4 rod antenna (for details, see page 16)



Displays and icons on the receiver's display panel

Standard display The standard display appears automatically after switch-on or when no button has been pressed on the receiver for a long period of time. The brightness of the standard display automatically dims after a few minutes.

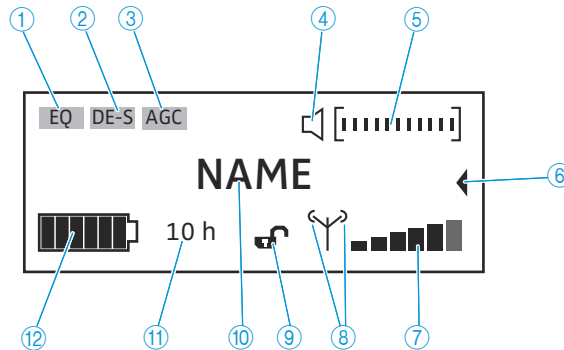

- ① Equalizer
If one of the equalizer functions is activated, **EQ** appears in inverse on the standard display (for details, see page 32).

- ② De-esser
If one of the de-esser functions is activated, **DE-S** appears in inverse on the standard display (for details, see page 33).

- ③ Auto gain control
If one of the compression functions is activated, **AGC** appears in inverse on the standard display (for details, see page 33).

- ④ **MUTE**
 - The received transmitter is not muted, but can be muted at any time (for details, see page 28).
 - The received transmitter is muted. In addition, the status LED lights up yellow.
 - The received transmitter cannot be muted because its **MUTE** switch is deactivated (for details see page 35).

- ⑤ Audio level display
The audio level is automatically optimally adjusted.

- ⑥ Extended standard display
The extended standard display appears when you turn the jog dial to the left (see page 10). The above shown standard display appears again after 10 seconds or when you turn the jog dial to the right.

- ⑦ 6-segment RF signal level display
Displays the field strength of the received signal. The 6-segment RF signal level display is also shown on the transmitter display panel.

- ⑧ RF output power of the receiver's back channel
 - Medium RF output power Displayed by the -H and -NH10 country variants.
 - High RF output power Only displayed by the -NH country variant.

- ⑨ Lock mode
 - Open padlock icon: The lock mode is temporarily deactivated and the receiver can be operated as usual.
 - Locked padlock icon: The lock mode is activated. Press and hold the jog dial to temporarily deactivate the lock mode. To permanently deactivate the lock mode, see page 34.

If no padlock icon is displayed, the lock mode is permanently deactivated (for details, see page 34).

- ⑩ Name of the radio link
To change this name, see page 32.

- ⑪ Remaining battery life of the received transmitter
This information is only displayed when the transmitter is powered via the optional accupack (for details, see page 27).

- ⑫ 7-segment display of the transmitter's battery or accupack capacity
The 7-segment battery or accupack capacity display is also shown on the transmitter display panel (for details, see page 27).



Extended standard display The extended standard display appears when you turn the jog dial to the left.

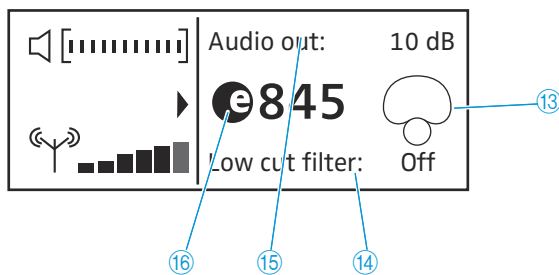

- ⑬ Pick-up pattern of the microphone used For details, see page 24.
- ⑭ Status of the low-cut filter (ON/OFF) For details, see page 32.
- ⑮ Output level of the receiver in dB For details, see page 34.
- ⑯ Product name of the microphone head used For details, see page 24.

Power supply units for the receiver

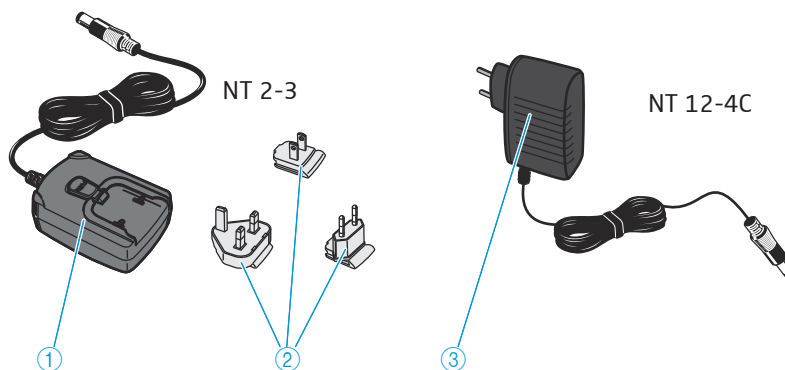

- ① NT 2-3 power supply unit Not available in Europe, the UK, and the USA.
- ② Interchangeable country adapters for plugging onto the NT 2-3
- ③ NT 12-4C power supply unit Country-specific variants are available in Europe, the UK, and the USA.



SKM D1, SKM-S D1 and SK D1 transmitters

Operating elements of the SKM D1 and SKM-S D1 handheld transmitters

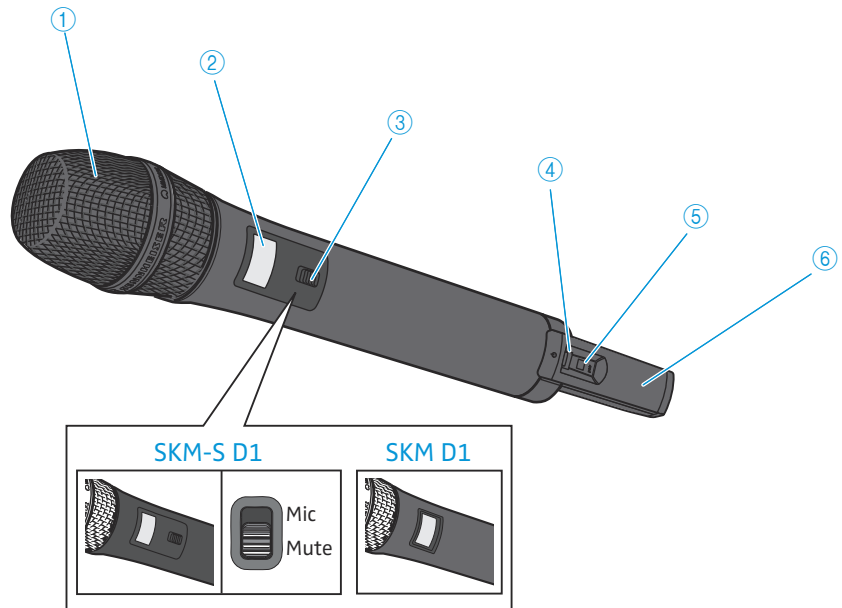

- ① Unscrewable microphone head
- ② Display panel
- ③ MUTE switch
- ④ ON/OFF button with status LED

* lights up green:

flashes green:

flashes alternately green and red:

* lights up yellow:

flashes red:

* lights up red:

- ⑤ PAIR button
- ⑥ Antenna

For details, see page 24.

i Do not cover the microphone head during transmission to avoid changing the characteristics of the pick-up pattern.

For details, see page 13.

for muting the SKM-S D1 handheld transmitter (for details, see page 28)

Short-press to switch the handheld transmitter on.

Long-press to switch the handheld transmitter off (for details, see page 26).

A radio link to the receiver is established. The batteries of the handheld transmitter are sufficiently charged.

The PAIR button has been short-pressed. Paired devices are being identified.

The PAIR button has been long-pressed. The handheld transmitter establishes a radio link to a receiver whose PAIR button has also been long-pressed.

The SKM-S D1 handheld transmitter has been muted with the MUTE switch. In addition, **Muted** is displayed on the display panel.

The battery capacity of the handheld transmitter is only sufficient for approx. 30 minutes of operation.

No radio link to a receiver. In addition, **No Link** is displayed on the display panel.

Short-press to identify the paired receiver (see page 29).

Long-press to change the pairing (see page 28).

i Do not touch the antenna during transmission to avoid a reduction in the transmission range.



Operating elements of the SK D1 bodypack transmitter

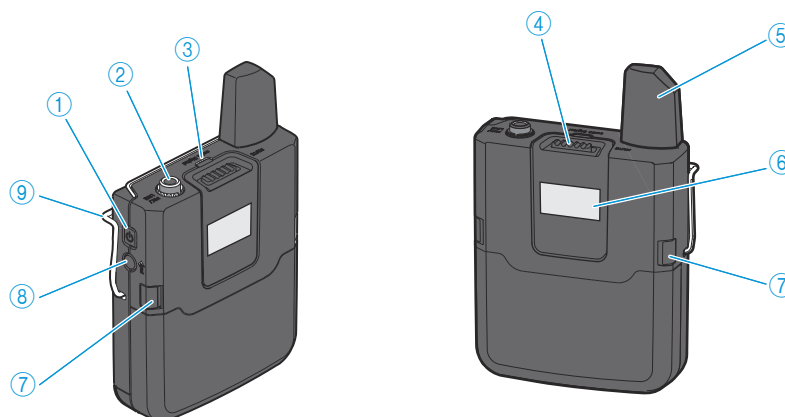

① ON/OFF button

Short-press to switch the bodypack transmitter on.
Long-press to switch the bodypack transmitter off (for details, see page 26).

② 3.5 mm jack socket
Mic/Line

for connecting the clip-on or headset microphone

③ Status LED ✱ lights up green:

A radio link to the receiver is established. The batteries of the bodypack transmitter are sufficiently charged.



The PAIR button has been short-pressed. Paired devices are being identified (for details, see page 29).

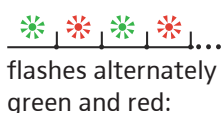

The PAIR button has been long-pressed. The bodypack transmitter establishes a radio link to a receiver whose PAIR button has also been long-pressed (for details, see page 28).

✱ lights up yellow:

The bodypack transmitter has been muted with the MUTE switch. In addition, **Muted** is displayed on the display panel (for details, see page 28).



The battery capacity of the bodypack transmitter is only sufficient for approx. 30 minutes of operation.

✱ lights up red:

No radio link to a receiver. In addition, **No Link** is displayed on the display panel.

④ MUTE switch

for muting the bodypack transmitter (for details, see page 28)

⑤ Antenna

i Do not touch the antenna during transmission to avoid a reduction in the transmission range.

⑥ Display panel

For details, see page 13.

⑦ Catches

Press simultaneously to release the battery box or the accupack.

⑧ PAIR button

Short-press to identify the paired receiver (see page 29).

Long-press to change the pairing (see page 28).

⑨ Belt clip

For details, see page 22.



Displays of the transmitters

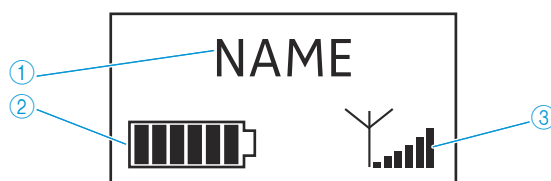

- ① Name of the radio link For details, see page 32.
- ② 7-segment display of the battery or accupack capacity For details, see page 27.
- ③ 6-segment RF signal level display Displays the field strength of the transmitted signal at the receiver.

Optional accessories for the transmitters

BA 10 accupack for the SKM D1 or SKM-S D1 handheld transmitter

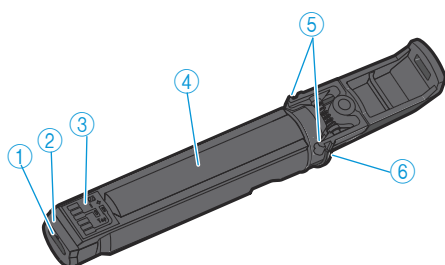

- ① Micro USB socket with cover flap for charging the accupack with any USB power supply/charger (for details, see page 25)
- ② Charge status LED * lights up red: The accupack is being charged
* lights up green: The accupack is fully charged
- ③ Contact surfaces for powering the handheld transmitter
- ④ Accupack contains the Li-Ion rechargeable battery
- ⑤ Catches Press simultaneously to release the accupack from the handheld transmitter.
- ⑥ Charging contacts for charging the accupack in the charging unit

BA 30 accupack for the SK D1 bodypack transmitter

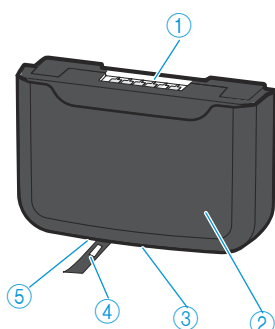

- ① Contact surfaces for powering the bodypack transmitter
- ② Accupack contains the Li-Ion rechargeable battery
- ③ Charging contacts for charging the accupack in the charging unit
- ④ Micro USB socket with cover flap for charging the accupack with any USB power supply/charger (for details, see page 25)
- ⑤ Charge status LED * lights up red: The accupack is being charged
* lights up green: The accupack is fully charged

USB power supply/charger for charging the accupacks

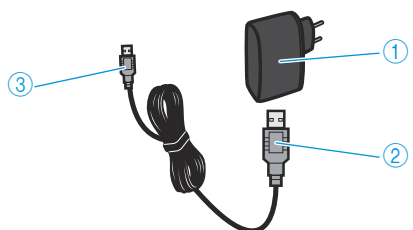

- ① NT 5-10-U USB power supply/charger (country-specific) for charging the accupacks
- ② USB connector (type A) for connection to the USB power supply/charger
- ③ Micro USB connector for connection to an accupack



ME 3-II headset microphone

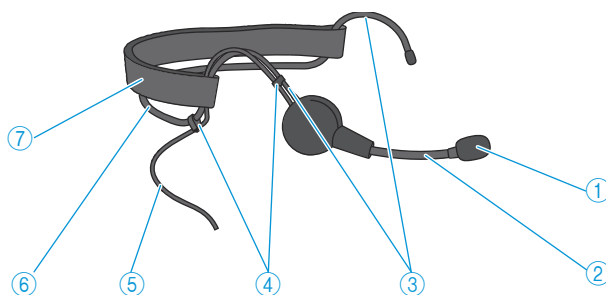

- ① Microphone capsule with lateral sound inlet and cardioid pick-up pattern with windshield

- ② Flexible microphone boom for precise positioning of the microphone at the corner of the mouth

- ③ Ear hooks for a secure fit on the ears

- ④ Clips for attaching the connection cable to the ear hook

- ⑤ Connection cable with lockable 3.5 mm jack plug

- ⑥ Neckband for a secure fit on the head

- ⑦ Neckband padding for a comfortable fit, adjustable in length with a Velcro fastener

ME 2-2 clip-on microphone

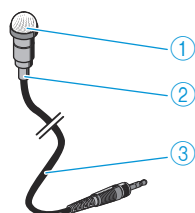

- ① Microphone capsule with windshield should be pointed towards the mouth

- ② Anti-kink protection to prevent cable damage

- ③ Connection cable (1.6 m) with lockable 3.5 mm jack plug for connection to the bodypack transmitter

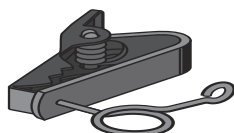

Supplied with microphone clip to attach the clip-on microphone to clothing.



Putting the products into operation

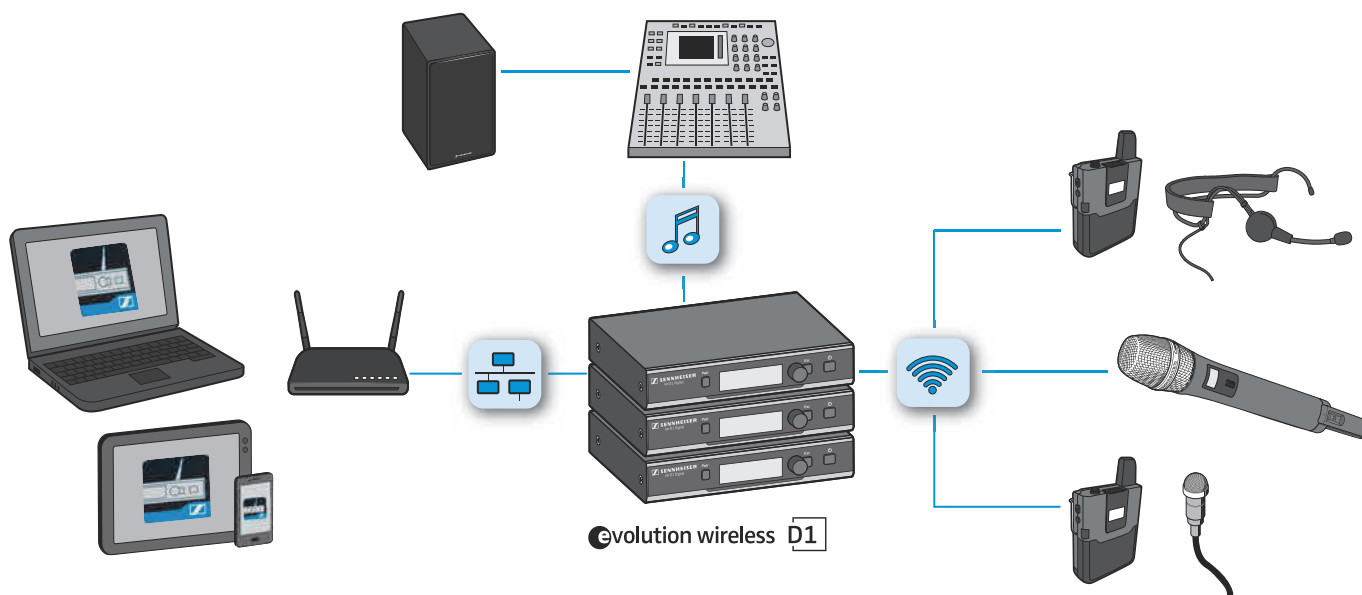

Avoiding sources of interference

Featuring automatic interference management, the devices are capable of avoiding interfering signals at any time by automatically moving together to unused frequencies in the 2.4 GHz frequency band, without any audio interruption. However, the number of usable radio links is reduced if there are active sources of interference in the vicinity of the devices.

- ▶ Switch off possible sources of interference operating in the 2.4 GHz frequency band.

Possible sources of interference use e.g. WiFi or Bluetooth.

Infrared remote controls and headphones, DECT headphones and UHF radio links (e.g. Sennheiser evolution wireless G3) do not represent a source of interference and can remain switched on.

i You can identify and locate sources of interference using a WiFi scanning tool.

- ▶ If you want to use WiFi while operating devices of the evolution wireless D1 series, use a dual-band WiFi router and deactivate its 2.4 GHz frequency band in order to minimize interference to the radio links.

If conditions are optimal, you can operate up to 15 radio links simultaneously (for details, see "Using the devices in multi-channel operation" on page 29).

Direct line of sight recommended

Walls and other obstacles will reduce the range. Therefore, there should always be a direct line of sight between the transmitting antenna and the receiving antennas of a radio link. To ensure this, you can mount the antennas of the receiver in different ways.

- When using the EM D1 as a stand-alone receiver, you can mount the supplied 2G4 rod antennas to the rear of the receiver (see page 16).
- When rack-mounting the receiver, you should use the GA 4 rack-mount kit to mount the receiver antennas to the front of the rack (see page 19).



Putting the receiver into operation

Fitting the device feet

ATTENTION

Risk of staining of furniture surfaces!

Some furniture surfaces have been treated with varnish, polish or synthetics which might cause stains when they come into contact with other synthetics. Despite a thorough testing of the synthetics used by us, we cannot rule out the possibility of staining.

- ▶ Do not place the receiver on delicate surfaces.

 Do not fit the device feet when mounting the receiver into a rack.

- ▶ Clean the recesses for the device feet at base of the receiver.
- ▶ Fit the device feet to the recesses of the receiver.
- ▶ Place the receiver on a flat, horizontal surface.
The device feet will adhere reliably to the receiver only after some time. Avoid moving the receiver during this time.

Mounting the rack mount "ears"

 The rack mount "ears" are designed to help protect the operating elements from damage or deformation, e.g. if the receiver is dropped.

- ▶ Therefore, always fasten the rack mount "ears", even if you do not want to rack mount the receiver.

To fasten the rack mount "ears":

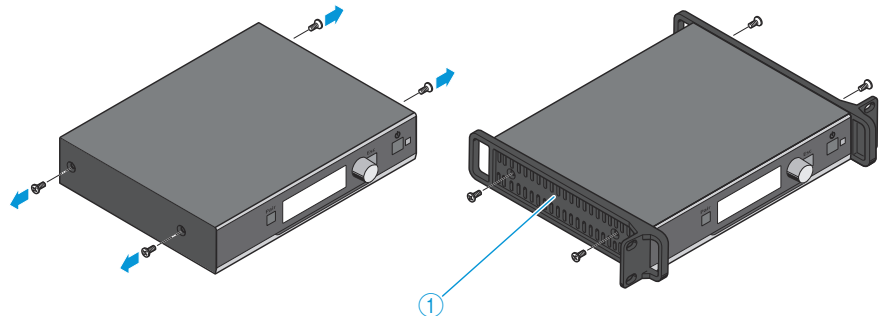

- ▶ Unscrew and remove the two recessed head screws on each side of the receiver.
- ▶ Secure the rack mount "ears" ① to the sides of the receiver using the previously removed recessed head screws.

Connecting the rod antennas to the receiver

The supplied 2G4 rod antennas can be mounted quickly and easily. The rod antennas are suitable for all applications where – good reception conditions provided – a wireless transmission system is to be used without a large amount of installation work

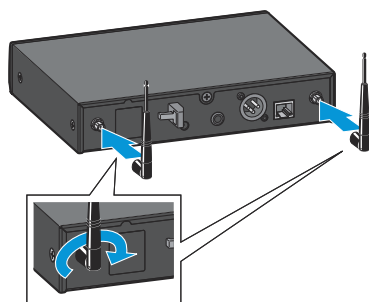

- ▶ Connect the supplied 2G4 rod antennas to the two R-SMA sockets at the rear of the receiver.
- ▶ Align the 2G4 rod antennas vertically upwards.

i When rack-mounting the receiver, you should use the GA 4 rack-mount kit to mount the receiver antennas to the front of the rack (see next chapter).

Mounting the receiver into a 19" rack

ATTENTION

Danger due to high temperature, mechanical loading or electric leakage currents

When rack-mounted, the receivers can be damaged by overheat or excessive mechanical loading.

- ▶ Make sure that the temperature within the rack does not exceed the permissible temperature limit specified in the specifications (see page 46).
- ▶ Make sure that the receivers in the rack are not mechanically loaded.
- ▶ Make sure that circuits are not overloaded by providing overcurrent protection, if necessary.
- ▶ Make sure that the sum of the leakage currents of all power supply units do not exceed the allowable limit values by grounding the rack via an additional ground connection, if necessary.

i Do not fit the device feet when mounting the receiver into a 19" rack.

For mounting one or several receiver into a rack, you require the optional GA 4 rack-mount kit. The GA 4 rack-mount kit is supplied with individually purchased receivers and is also available separately as an accessory.

Using the GA 4 rack-mount kit, you can:

- mount a single receiver into a 19" rack (see page 18),
- mount the two 2G4 rod antennas to the front of the rack (see page 19) or
- mount two receivers side by side into a 19" rack (see page 19).

The GA 4 rack-mount kit consists of:

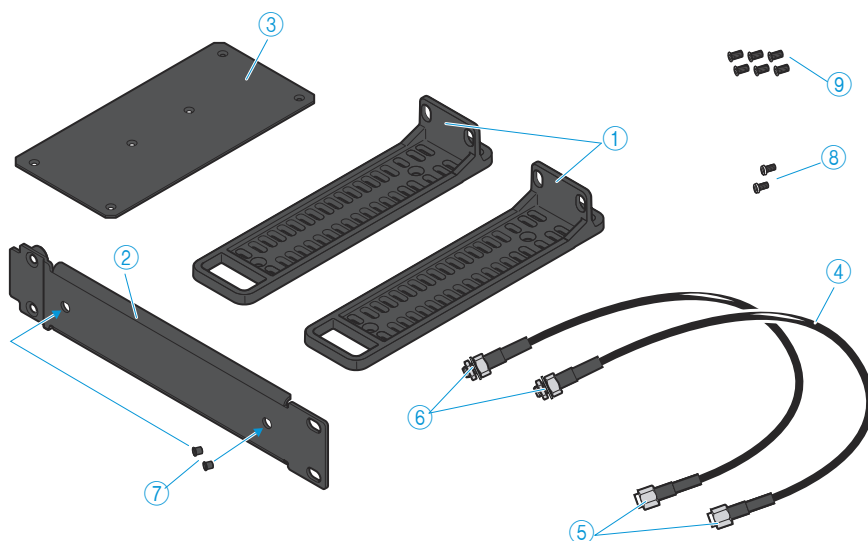



- ① 2 rack mount "ears"
- ② 1 blanking plate
- ③ 1 jointing plate
- ④ 2 R-SMA extension cables
- ⑤ Screw-in R-SMA sockets
- ⑥ R-SMA connectors with washers and nuts
- ⑦ 2 blanking plugs for closing off the antenna holes in the blanking plate
- ⑧ 2 recessed head screws
- ⑨ 6 recessed head screws

Mounting a single receiver into a rack

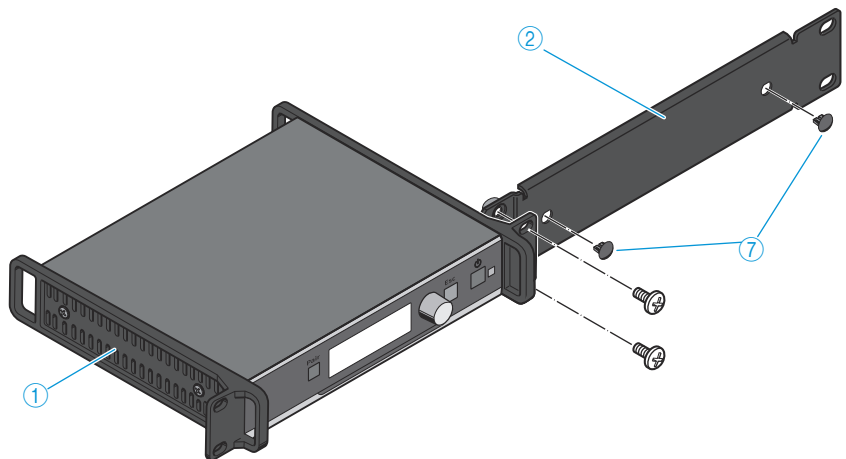

- ▶ Unscrew and remove the four screws located on the sides of the receiver housing.
- ▶ Secure the rack mount "ears" ① to the sides of the receiver using the previously removed recessed head screws (see right-hand diagram). Make sure that the angled ends of the rack mount "ears" point forward.
- ▶ Secure the blanking plate ② to one of the rack mount "ears" ① using the two recessed head screws ⑧. Make sure to use the correct side (the one with the round holes) of the blanking plate ② to secure it to the rack mount "ear".

If you want to mount the supplied rod antennas to the front of the rack:

- ▶ Read the next section.

If you do not want to mount the supplied rod antennas to the front of the rack:

- ▶ Insert the two blanking plugs ⑦ into the unused antenna holes.
- ▶ Slide the receiver into the 19" rack.
- ▶ Secure the rack mount "ears" ① and the blanking plate ② to the rack.



Mounting the rod antennas to the front of the rack

When mounting only one receiver into a rack, you can mount the receiver's antenna connections to the front of the rack. This can improve reception.

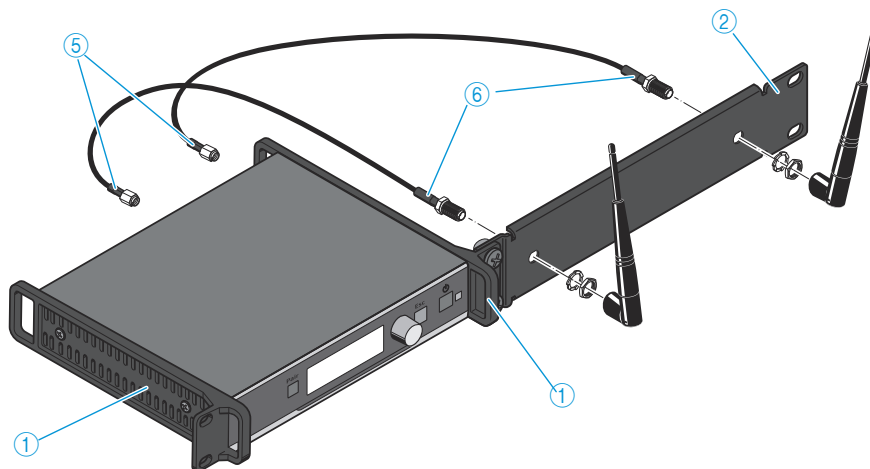

- ▶ Screw the two R-SMA sockets ⑥ of the R-SMA extension cables to the blanking plate ② using the supplied washers and nuts.
- ▶ Connect the two R-SMA connectors ⑤ to the R-SMA sockets of the receiver.
- ▶ Slide the receiver into the 19" rack.
- ▶ Secure the rack mount "ears" to the rack.
- ▶ Connect the two 2G4 rod antennas to the R-SMA sockets ⑥ of the blanking plate ②.

Mounting two receivers into a rack

You can mount two receivers side by side into a rack.

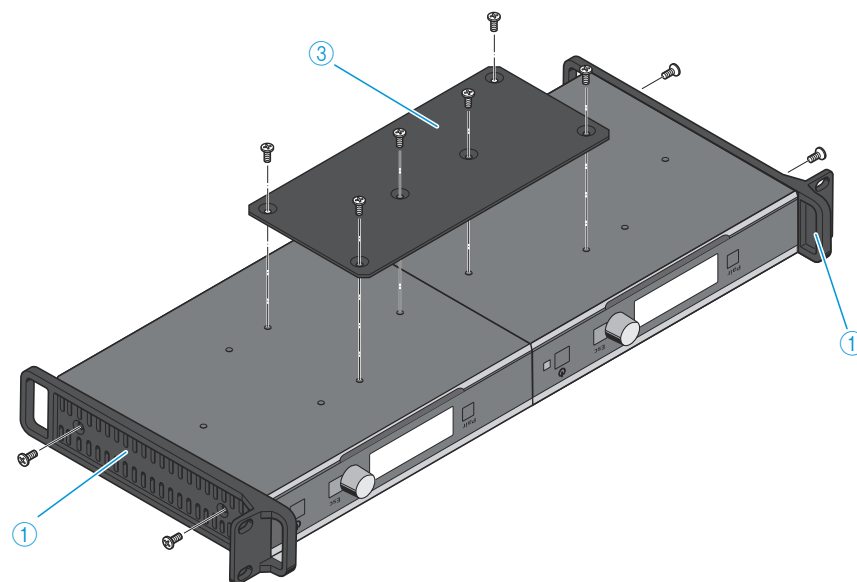

- ▶ Place the two receivers side by side upside-down onto a flat surface.
- ▶ Align the jointing plate ③ over the holes in the bottom sides of the receivers.
The jointing plate must be placed centrally over the two receivers.
- ▶ Secure the jointing plate ③ to the receivers using the six recessed head screws ④.



- ▶ Unscrew and remove the four screws located on the sides of the receiver housings.
- ▶ Secure the rack mount "ears" ⑩ to the sides of the receivers using the previously removed recessed head screws. Make sure that the angled ends of the rack mount "ears" point forward.
- ▶ Slide the receivers into the 19" rack.
- ▶ Secure the rack mount "ears" ⑩ to the rack using the recessed head screws 8.

Connecting the receiver to a mixing console

The receiver's 1/4" (6.3 mm) jack socket ⑩ and the XLR-3 socket ⑪ are connected in parallel, allowing you to simultaneously connect two devices (e.g. amplifier, mixing console) to the receiver.

- ▶ Use a suitable cable to connect the mixing console to the 1/4" (6.3 mm) jack socket ⑩ or the XLR-3 socket ⑪.

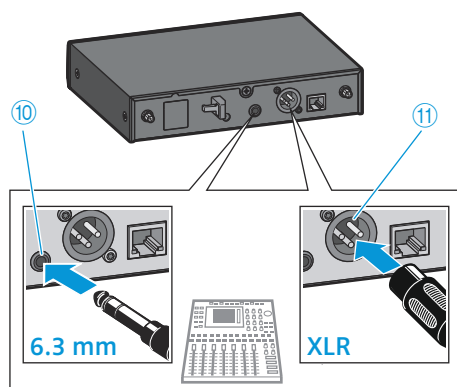

Connecting receivers in a network



You can connect several receivers in a network using a router or a switch. This allows you to e.g. control, monitor and update all receivers and transmitters of a multi-channel system via a mobile device or a computer.

"WSR" app

Together with the "Wireless System Remote" (WSR) app, you can use one or several mobile devices to remotely configure all receivers and transmitters of a multi-channel system, to monitor their operation and to update the firmware of the devices (for details, see page 38).

For this, you require a dual-band WiFi router, a sufficient number of network cables and at least one mobile device (tablet or smartphone).

"Sennheiser D1 SL Updater" software

You can use the "Sennheiser D1 SL Updater" software to update the device firmware (for details, see page 39).

For this, you require any router or a switch, a sufficient number of network cables and a computer running Windows 7 or higher.

i Updating the firmware without a network

If you do not have a router or a switch and only want to update the firmware:

- ▶ Assign the computer a static IP address.
- ▶ Assign the receiver a static IP address (**Network Settings – Mode – Fixed IP**) and then restart the receiver.
- ▶ Connect the receivers directly to the computer one after the other and update their firmware.

To connect several receivers in a network using a router or a switch:

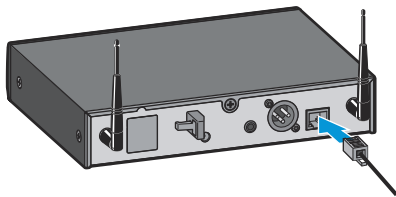

- ▶ Connect a standard network cable (at least Cat 5) to the LAN Ethernet socket of your receiver.
 - ▶ Connect your receiver to the Ethernet switch or the dual-band WiFi router.
 - ▶ Connect either a computer to the Ethernet switch or connect the computer or the mobile devices to the WiFi router.
- The yellow LED at the rear of the receiver indicates the connection status.

Yellow LED ...	Connection status
... lit	The receiver is connected to the network.
... off	The receiver is not connected to the network.

- ▶ Use a strong password and a strong encryption algorithm to protect your WiFi or your router against unauthorized access.
- ▶ Deactivate the WiFi router's 2.4 GHz frequency band in order to minimize interference to the radio links.

To update the firmware of your devices:

- ▶ Establish an Internet connection with your mobile device or computer to download the current firmware.

Connecting the receiver to the power supply system

Only use the supplied power supply unit (NT 12-4C or NT 2-3). It is designed for your receiver and ensures safe operation.

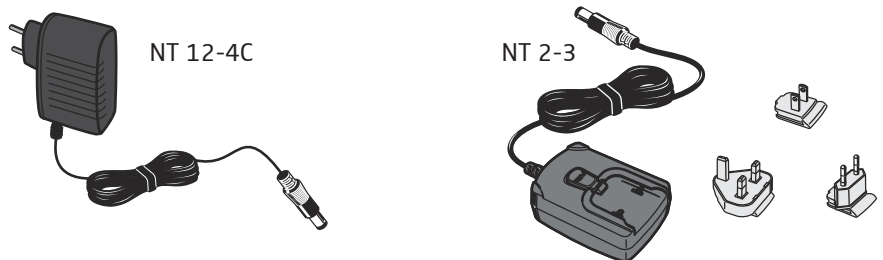

If you use the NT 2-3 power supply unit:

- ▶ Slide the supplied country adapter onto the power supply unit.

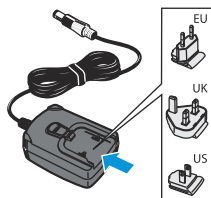

To connect the power supply unit:

- ▶ Pass the cable of the power supply unit through the cable grip as shown on the left.

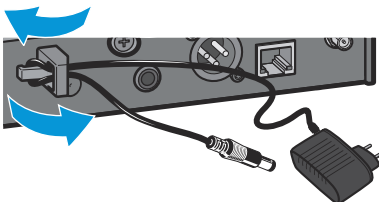

- ▶ Connect the hollow jack plug of the power supply unit to the DC IN socket of the receiver.

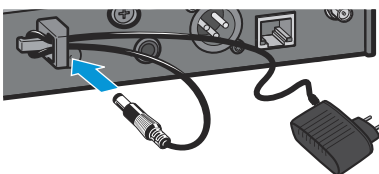

- ▶ Plug the power supply unit into the wall socket.

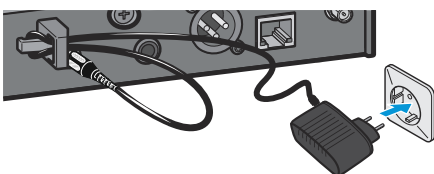



Putting the bodypack transmitter into operation

Removing/inserting the batteries or the optional accupack

You can power the bodypack transmitter with the supplied B 30 battery box and two 1.5 V AA size batteries.

i Optionally, you can also use the Sennheiser BA 30 accupack (3.6 V). The accupack must be charged before first time use. The accupack can remain in the bodypack transmitter for charging.

If you use the supplied B 30 battery box to power the bodypack transmitter:

- ▶ Insert the batteries into the B 30 battery box. Please observe correct polarity when inserting the batteries.

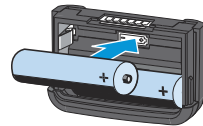

To remove the battery box or the accupack:

- ▶ Simultaneously press the two catches and pull the battery box or the accupack away from the bodypack transmitter.

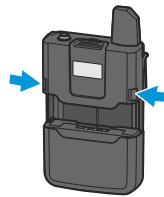

To insert the battery box or the accupack:

- ▶ Slide the battery box or the accupack onto the bodypack transmitter as shown. The battery box or the accupack locks into place with an audible click.

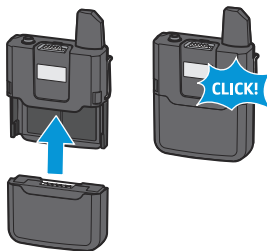

Attaching the bodypack transmitter to clothing

You can use the belt clip to attach the bodypack transmitter to clothing (e.g. belt, waistband).

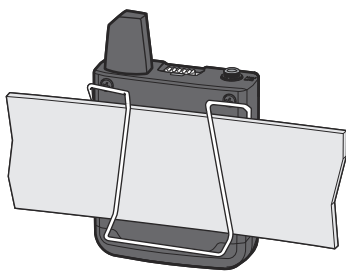

Connecting the clip-on microphone or the headset microphone to the bodypack transmitter

Only connect the clip-on microphone or the headset microphone recommended by Sennheiser. These microphones are optimized for the bodypack transmitter.

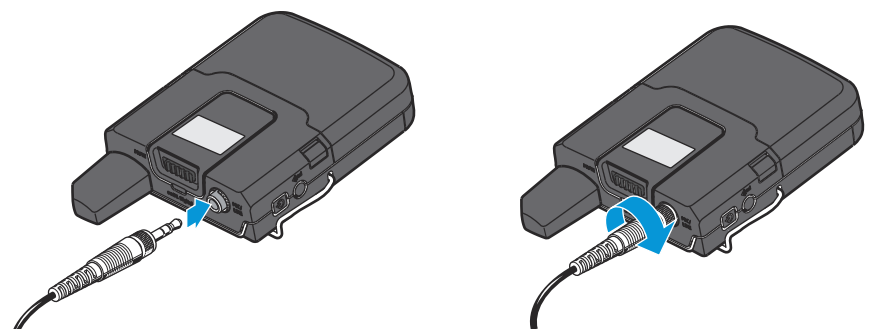

- ▶ Connect the jack plug of the clip-on microphone or the headset microphone to the 3.5 mm jack socket (Mic/Line) of the bodypack transmitter.
- ▶ Lock the jack plug by screwing down the coupling ring.



Preparing the headset microphone for use

Adjusting the microphone boom and the neckband padding

For best possible comfort and optimum fit of the headset microphone, the neckband padding and the microphone boom have to be adjusted to properly fit your head.

ATTENTION

Damage to the microphone boom

The microphone boom can break or be impaired in its function when you bend or turn it. Frequent alternate bendings close to the microphone head can also damage the microphone boom and possibly reduce the adjustability of the microphone.

- ▶ Only adjust the microphone boom as described in this chapter.

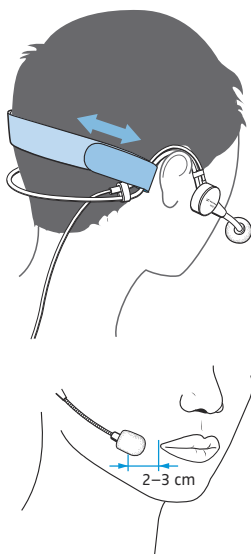

- ▶ Put on the headset microphone and adjust it so that a comfortable and secure fit is ensured.

Make sure to wear the neckband padding around the back of your head. If the neckband padding is worn too close to the top of the head, it can slip out of position.

- ▶ Change the length of the headband padding by means of the Velcro fastener to ensure a snug and comfortable fit.

- ▶ Adjust the microphone boom so that the sound inlet points towards the mouth and is positioned approx. 2 to 3 cm from the corner of the mouth.

Using the windshield

The windshield attenuates annoying wind noise by 10 dB.

- ▶ Slip the windshield onto the microphone capsule.

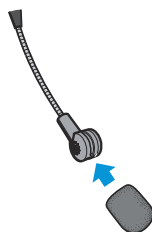

Attaching the clip-on microphone to clothing

The ME 2-2 clip-on microphone is supplied with a microphone clip.

- ▶ Use the microphone clip to attach the clip-on microphone to clothing (e.g. tie, lapel).
- ▶ Conduct the cable so that noise due to friction is avoided and that the connection cable and the antenna do not cross.
- ▶ Attach the microphone at a distance of approx. 20 cm to the mouth. The clip-on microphone has an omni-directional pick-up pattern. It is therefore not necessary to position it precisely.

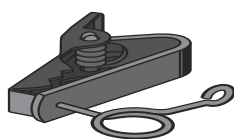



Putting the handheld transmitter into operation

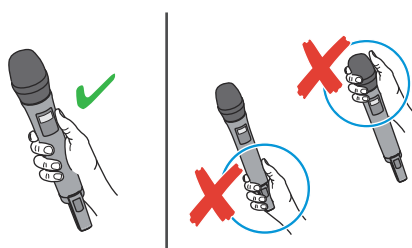

If you touch the antenna of the handheld transmitter during transmission, the transmission range will be considerably reduced. If you cover the microphone head during transmission, this will change the pick-up pattern of the microphone and consequently the sound.

- ▶ Only hold the handheld transmitter by its body.
- ▶ Hold the handheld transmitter approx. 5 to 10 cm in front of your mouth.

The MMD 845-1 and MMD 945-1 microphone heads have a super-cardioid pick-up pattern.

- ▶ Hold the handheld transmitter vertically and speak into the sound inlet basket from directly above.

The MMD 835-1 and MMD 935-1 microphone heads have a cardioid pick-up pattern.

- ▶ You can speak into the sound inlet basket from directly above or from slightly off-axis.

Removing/inserting the batteries or the optional accupack

You can power the handheld transmitter with the supplied B 10 battery box and two 1.5 V AA size batteries.

i Optionally, you can also use the Sennheiser BA 10 accupack (3.6 V). The accupack must be charged before first time use (see page 25).

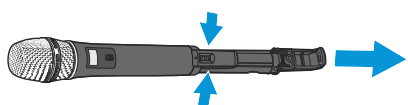

To remove the battery box or the accupack:

- ▶ Simultaneously press the two catches and pull the battery box or the accupack away from the handheld transmitter.

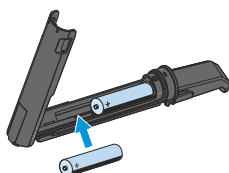

If you use the supplied B 10 battery box:

- ▶ Insert the batteries into the B 10 battery box. Please observe correct polarity when inserting the batteries.
- ▶ Close the battery box.

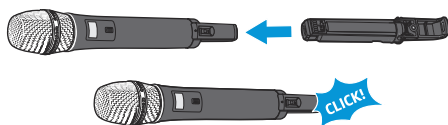

To insert the battery box or the accupack:

- ▶ Slide the battery box or the accupack onto the handheld transmitter as shown. The battery box or the accupack locks into place with an audible click.

Changing the microphone head

The handheld transmitter comes in different sets, including either the MMD 835-1, MMD 845-1, MMD 935-1 or the MMD 945-1 microphone head. You can unscrew the microphone head and replace it by another one, e.g. one with a different pick-up pattern.

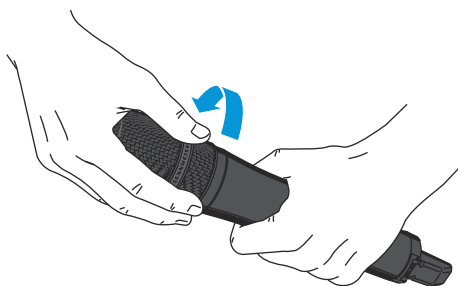



Recharging the accupack

If you use the optional BA 10 or BA 30 accupacks, you can charge them via a standard USB power supply/charger or via the USB port of a computer.

The BA 30 accupack of the bodypack transmitter can remain in the bodypack transmitter for charging. To charge the BA 10 accupack of the handheld transmitter:

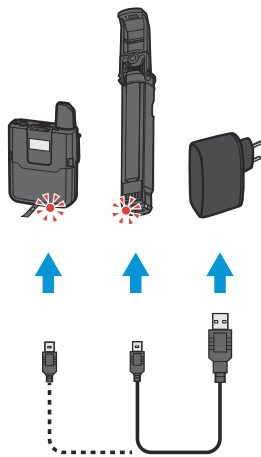

- ▶ Remove the accupack from the handheld transmitter (see page 22).
- ▶ If the accupack's micro USB socket has a cover flap: Open the cover flap of the micro USB socket and connect the micro USB connector of the USB cable to the micro USB socket of the accupack.
- ▶ Connect the USB connector of the USB cable to the USB socket of the USB power supply/charger or to the USB port of a computer.
- ▶ Plug the USB power supply/charger into the wall socket.
The charge status LED lights up red when the accupack is being charged.
The charge status LED lights up green when the accupack is fully charged.



Using the products

The Sennheiser evolution wireless D1 series offers true ease of use: The devices of a set are already paired and are therefore ready for immediate use. The receiver features automatic frequency management and continually scans the RF environment for usable, interference-free frequencies. To ensure optimum levels, the transmitters automatically set the correct microphone sensitivity.

Switching the devices on or off

i After switch-on, the receivers and transmitters will take approx. 10 seconds to establish the radio links. The more devices are switched on, the longer it takes to establish all the radio links.

Switching the receiver on

- ▶ Short-press the **STANDBY** button.
After switch-on, the display panel first shows a logo and then the standard display (see page 9). The status LED indicates the current status of the receiver (see page 8). The radio link to the last paired transmitter is established automatically as soon as the paired transmitter is switched on.

Switching the receiver off

- ▶ Long-press the **STANDBY** button.
The display panel and the status LED go off.

Switching the bodypack transmitter on

- ▶ Short-press the **ON/OFF** button.
The standard display appears on the display panel (see page 13). The status LED indicates the current status of the bodypack transmitter (see page 12). The radio link to the last paired receiver is automatically established as soon as the paired receiver is switched on.

Switching the bodypack transmitter off

- ▶ Long-press the **ON/OFF** button.
The display panel and the status LED go off.

Switching the handheld transmitter on

- ▶ Short-press the **ON/OFF** button in the direction of the transmitter body.

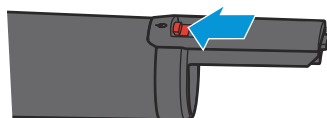

The standard display appears on the display panel (see page 13). The status LED indicates the current status of the handheld transmitter (see page 11). The radio link to the last paired receiver is automatically established as soon as the paired receiver is switched on.

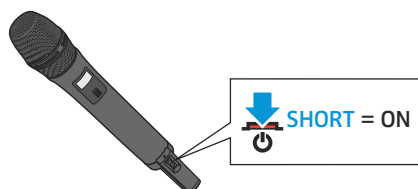
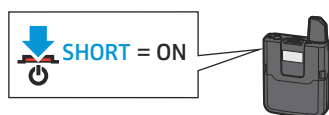
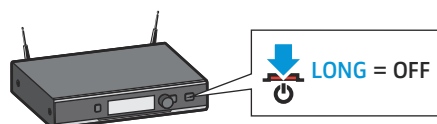
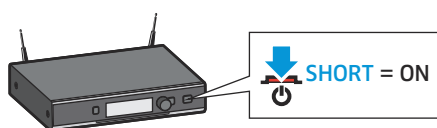



Switching the handheld transmitter off

▶ Long-press the **ON/OFF** button in the direction of the transmitter body.

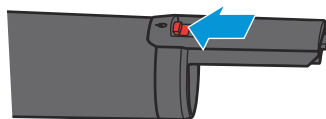
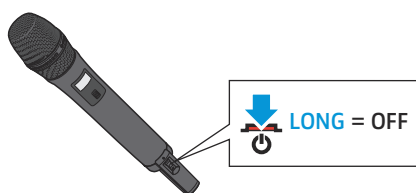

The display panel and the status LED go off.

Checking the charge status of the batteries or accupacks



When the capacity of the batteries or the accupack is so low that the remaining battery life is less than 30 minutes, the status LED on both the transmitter and the receiver flashes red.



In addition, the empty battery icon flashes on the display panel of both the receiver and the transmitter.

Battery status display

If you power the transmitter with batteries, a 6-segment battery icon is shown on the display panel of both the receiver and the transmitter:



Accupack status display

If you power the transmitter with the optional accupack, the expected battery life is shown on the display panel of both the transmitter and the receiver:



Checking the RF signal level

The field strength of the RF signal received by the receiver is shown on the display panel of both the receiver and the transmitter.



If no RF signal is being received, e.g. because the paired device is switched off or out of range, all segments of the RF signal level display are grayed out. In addition, the background of the display panel changes back and forth between light and dark and **No Link** \triangle appears on the display panel.



Muting the bodypack transmitter or the SKM-S D1 handheld transmitter

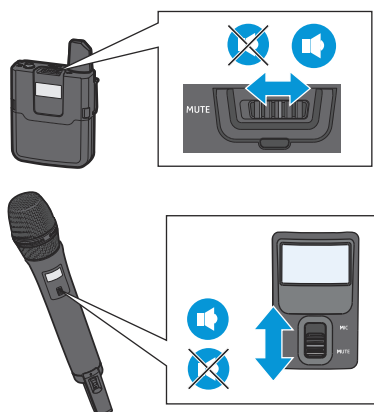

Both the bodypack transmitter and the SKM-S D1 handheld transmitter have a **MUTE** switch that mutes the audio signal without switching the transmitter off.

i In order that a transmitter can be muted, its **MUTE** switch must be activated (see page 35). If you try to mute a transmitter whose **MUTE** switch is deactivated, **Mute disabled**  appears on the display panel of both the transmitter and the receiver.



The SKM D1 handheld transmitter has no **MUTE** switch and can therefore not be muted.

- ▶ Slide the **MUTE** switch to the position **MUTE**. **Muted**  appears on the display panel of both the transmitter and the paired receiver. The status LED on both the transmitter and the paired receiver lights up yellow.
- ▶ Slide the **MUTE** switch back to the initial position to unmute the audio signal.

Pairing a receiver with a transmitter

i The receiver and the transmitter of a set are factory pre-paired and therefore ready for immediate use. The radio link is automatically established as soon as both devices are switched on. You can disconnect the existing radio link and establish new radio links to two other devices.

To establish a new radio link between a receiver and a transmitter, proceed as follows:

- ▶ Switch on the receiver and the transmitter that you want to pair (see page 26).
The status LED on both the receiver and the transmitter indicates the current device status (see page 8).
- ▶ Long-press the **PAIR** button of the receiver until its status LED flashes alternately green and red.
Identify appears on the display panel of the receiver, followed by the message **Pairing**. An existing radio link is now disconnected. You now have 90 seconds to establish a radio link with a new transmitter.
- ▶ Long-press the **PAIR** button of the transmitter until its status LED flashes alternately green and red.
Press pair on receiver appears on the transmitter display panel.
- ▶ Wait for approx. 10 seconds until the radio link is established.
 - Once the radio link is successfully established, **Paired**  appears on the display panel of both the receiver and the transmitter and the status LED on the transmitter and the receiver lights up green.
 - If no radio link can be established, **Pairing failed**  appears on the display panel of both the receiver and the transmitter and the status LED on the transmitter and/or the receiver lights up red.
 - If you try to pair devices that are running incompatible firmware versions, a message appears on the display panel prompting you to update the firmware of the transmitter. If you update the firmware now, the transmitter and the receiver will be paired afterwards; if you do not update the firmware, the transmitter and the receiver will not be paired and **FW mismatch**  appears on the display panel of the receiver.

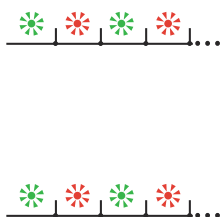



ATTENTION

Breakdown of radio links during the firmware update

All radio links are subject to interference during the firmware update process and can therefore not be used for audio transmission.

- ▶ Never update the firmware during a performance.

Identifying paired devices

You can perform a pairing identification to see which transmitter is paired with which receiver.

- ▶ Switch on all devices whose pairing you want to identify (see page 26).
 - ▶ Short-press the **PAIR** button of the receiver or of the transmitter. The status LEDs of the paired devices flash for 10 seconds. **Identify** appears on the receiver display panel. **This is** plus the name of the radio link appear on the transmitter display panel.
- If the receiver or the transmitter is not paired or if the paired device is not switched on or out of range, the display panel changes back to the standard display after 10 seconds.



Using the devices in multi-channel operation

If you only want to use up to six radio links simultaneously, you do not have to follow a special switch-off/switch-on sequence. If you want to use more than six radio links simultaneously, you may have to follow a special switch-off/switch-on sequence.

- ▶ Proceed as described in the enclosed "Multichannel Operation" leaflet.

Switching between the standard display and the extended standard display

To switch from the standard display to the extended standard display:

- ▶ Turn the jog dial to the left.

 After 10 seconds, the display panel automatically changes from the extended standard display back to the standard display.

To manually change from the extended standard display back to the standard display before 10 seconds have elapsed:



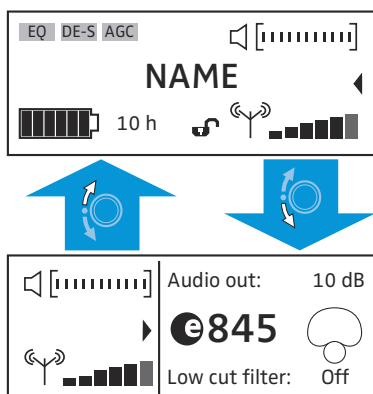

- ▶ Turn the jog dial to the right.





Using the operating menu of the receiver

Using the buttons for navigation

Button	Function
 Press the STANDBY button	<ul style="list-style-type: none"> • Short-press: Switches the receiver on • Long-press: Switches the receiver off
 Short-press the ESC button	<ul style="list-style-type: none"> • Navigates to the next higher level in the menu • Exits the menu item without storing changes to the settings
 Long-press the ESC button	<ul style="list-style-type: none"> • Returns to the standard display
 Press the jog dial	<ul style="list-style-type: none"> • Changes from the current standard display to the operating menu • Calls up the selected menu item • Changes to the selected submenu
 Turn the jog dial	<ul style="list-style-type: none"> • Switches between the standard display and the extended standard display • Changes to the previous or next menu item • Changes the settings of a menu item

Overview of the operating menu of the receiver

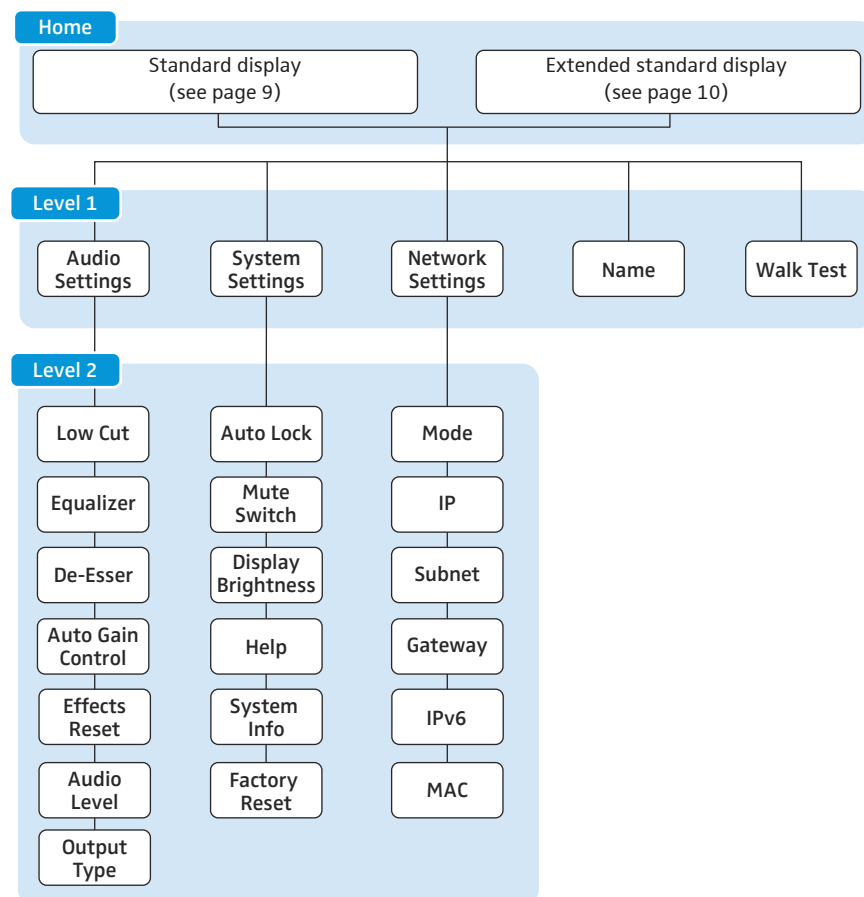



Level 1	Level 2	To ...	See ...
Audio Settings	Low Cut	filter out low-frequency noise	page 32
	Equalizer	select a sound profile or manually adjust the equalizer	page 32
	De-Esser	attenuate sibilants	page 33
	Auto Gain Control	activate/deactivate the dynamic compression	page 33
	Effects Reset	reset all audio settings to the factory default settings	page 33
	Audio Level	fine-tune the receiver's output level	page 34
	Output Type	adjust the receiver's output level to match the input (mic or line) of the connected device	page 34
	Exit	exit Level 2 and return to Level 1	
System Settings	Auto Lock	activate/deactivate the automatic lock mode	page 34
	Mute Switch	activates/deactivate the transmitter's MUTE switch	page 35
	Display Brightness	change the brightness of the display panel	page 35
	Help	display the QR codes for the help functions	page 35
	System Info	display the firmware version and serial number	page 36
	Factory Reset	reset the receiver to the factory default settings	page 36
	Exit	exit Level 2 and return to Level 1	
Network Settings	Mode	change the IP address assignment mode	page 36
	IP	change the IP address	page 36
	Subnet	change the subnet mask	page 36
	Gateway	change the gateway address	page 37
	IPv6	display the IPv6 address	page 37
	MAC	display the MAC address	page 37
	Exit	exit Level 2 and return to Level 1	
Name	–	change the name of the radio link	page 32
Walk Test	–	check the reception quality within the operating environment	page 37
Exit	–	exit the operating menu and return to the standard display	



Changing the name of the radio link

You can change the name of the radio link. This name is displayed on the display panels of the paired devices.

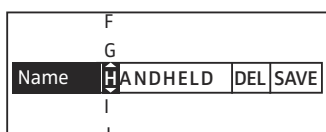

- ▶ Select **Name**.
- ▶ Select and confirm the character that you want to change. Then select the new character.
You can enter up to 8 capital letters from **A** to **Z** and digits from **0** to **9**.

To delete the selected character:

- ▶ Select **DEL** and confirm by pressing the jog dial.

To store the entered name:

- ▶ Select **SAVE** and confirm by pressing the jog dial.

Activating/deactivating the low-cut filter

You can filter out low-frequency noise caused, for example, by the proximity effect of the microphone or by wind.

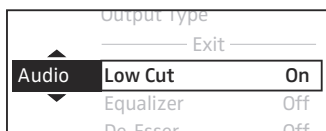

- ▶ Select **Audio Settings – Low Cut**.

Setting	Meaning
On	The low-cut filter is activated. Low-frequency noise is filtered out. This setting is recommended if you mainly want to transmit speech.
Off	The low-cut filter is deactivated. Low-frequency noise is not filtered out. This setting is recommended if you want to transmit music or sound effects with a dominant bass component.

Adjusting the equalizer

You can adjust a sound profile to e.g. improve speech intelligibility or adjust the sound to the room acoustics.

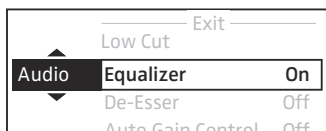

- ▶ Select **Audio Settings – Equalizer**.
You can select an existing sound profile or manually adjust the equalizer.

To select an existing sound profile:

- ▶ Select the desired sound profile.
If one of the equalizer functions is activated, **EQ** appears in inverse on the standard display.

To manually adjust the equalizer:

- ▶ Select **Custom**.
The equalizer is displayed.

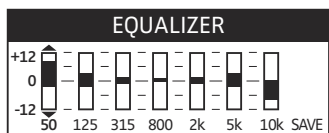

- ▶ Select one of the seven frequencies (**50, 125, 315, 800, 2k, 5k or 10k**) and press the jog dial.

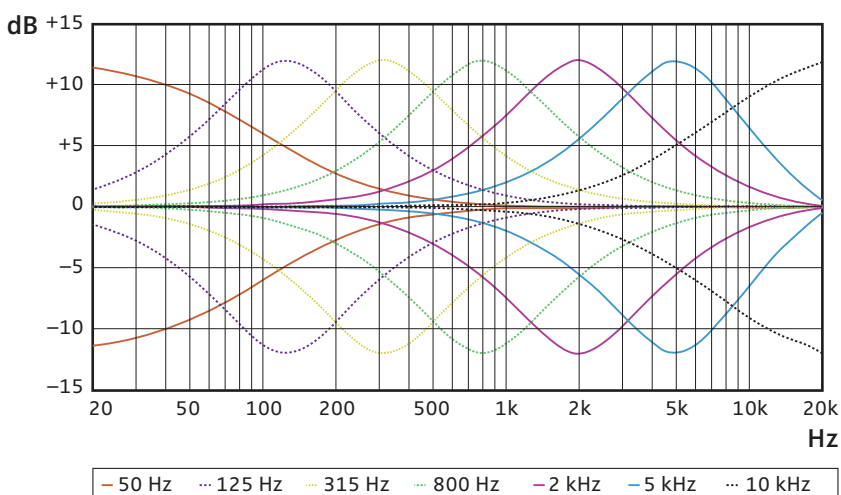

- ▶ Turn the jog dial to increase or reduce the selected level. Turning the jog dial by one notch increases or reduces the level by 1 dB. You can increase or reduce the level by a maximum of 12 dB. Your setting is represented by bars.
- ▶ Press the **ESC** button.
- ▶ Select the next frequency and repeat the steps.
- ▶ Once you have adjusted all frequency bands as desired, confirm with **SAVE**.

Adjusting the de-esser

You can attenuate sibilance in vocals and speech.

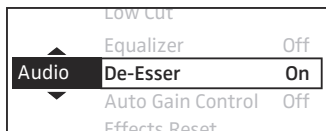

- ▶ Select **Audio Settings – De-Esser**.
- ▶ Select the desired profile. If one of the de-esser functions is activated, **DE-S** appears in inverse on the standard display.

Activating/deactivating the dynamic compression

You can activate one of the dynamic compression profiles in order to boost very quiet passages and to attenuate particularly loud passages. You can choose from preset profiles for different situations.

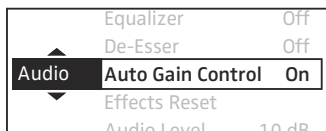

- ▶ Select **Audio Settings – Auto Gain Control**.
- ▶ Select the desired profile. If one of the dynamic compression profiles is activated, **AGC** appears in inverse on the standard display.

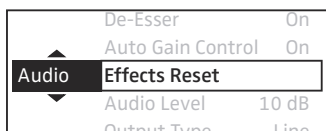

Resetting the audio settings

The **Effects Reset** menu item allows you to reset the receiver’s audio settings made in the **Audio Settings** menu to the factory default settings. All other receiver settings remain unchanged.



Coarsely adjusting the output level of the receiver (Mic/Line)

You can coarsely adjust the output level of the receiver to match the input (mic or line) of the connected mixing console.

- ▶ Select **Audio Settings – Output Type**.

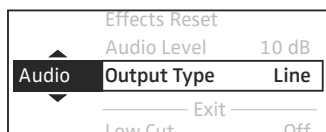

Setting	Meaning
Line	The output level is adjusted to match a line input.
Mic	The output level is adjusted to match a mic input.

Fine-tuning the output level of the receiver

You can fine-tune the output level of the receiver to match the input (mic or line) of the connected mixing console.

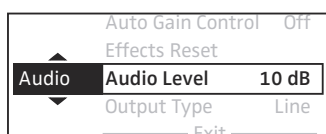

- ▶ Select **Audio Settings – Audio Level**.
- ▶ Turn the jog dial to increase or reduce the audio level.
Turning the jog dial by one notch increases or reduces the audio level by 1 dB. You can adjust the audio level between 0 dB and 30 dB.



Activating/deactivating the lock mode

The receiver is delivered with the lock mode deactivated. This is indicated by the open padlock icon on the standard display as shown on the left.

To activate the lock mode:

- ▶ Select **System Settings – Auto Lock – On**.
Stored ✓ appears on the display panel. The open padlock icon  appears on the standard display for 10 seconds. If, during these 10 seconds, no button is actuated on the receiver, the lock mode is activated and the locked padlock icon  appears on the standard display.
The lock mode prevents that the receiver is accidentally switched off or that settings are inadvertently changed during operation. If one of the receiver buttons is actuated while the lock mode is activated, **Locked ** and **To unlock press & hold SET** appears on the display panel of the receiver.

To temporarily deactivate the lock mode:

- ▶ Long-press the jog dial.
Unlocked ✓ appears on the display panel.
The open padlock icon  appears on the standard display and the lock mode is deactivated for 10 seconds. If, during these 10 seconds, no button is actuated on the receiver, the lock mode is automatically activated again.

To permanently deactivate the lock mode:

- ▶ If the lock mode is temporarily deactivated, select **System Settings – Auto Lock – Off**.
Stored ✓ appears on the display panel. The lock mode icon no longer appears on the standard display.

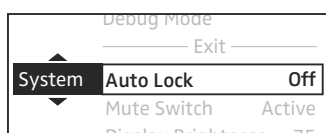



Activating/deactivating the MUTE switch of the transmitter

From the receiver, you can activate or deactivate the **MUTE** switch of the received transmitter. This setting determines whether or not the transmitter can be muted.

- ▶ Select **System Settings – Mute Switch**.

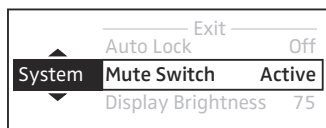

Setting	Meaning
Active	The MUTE switch of the transmitter is activated. Depending on the position of the MUTE switch of the received transmitter, either the icon for a muted transmitter (⊘) or the icon for an unmuted transmitter (◀) appears on the standard display.
Deactivated	The MUTE switch of the transmitter is deactivated. The following icon appears on the standard display: ⊘ If the MUTE switch of the transmitter is actuated, Mute disabled ⊘ appears on the display panel of the receiver.

Adjusting the display brightness

The brightness of the receiver display panel can be adjusted in 16 steps.

- ▶ Select **System Settings – Display Brightness**.

Turning the jog dial by one notch increases or reduces the brightness by 5%. The brightness can be reduced to a minimum of 25%.

The brightness automatically dims after a few minutes.

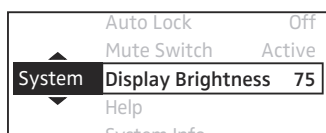



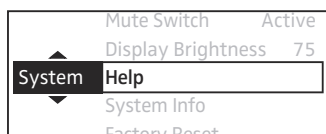

Calling up help functions

For more information and help on the use and operation of your receiver or your evolution wireless **D1** system, you can call up different help functions by scanning the QR codes displayed on the receiver display panel or by following the links given below.

- ▶ Select **System Settings – Help**.
- ▶ Select the desired help function.



Selection	Help function	QR code	Link
Setup Guide	You are redirected to the page for downloading the setup guide.		sennheiser.com/D1-setup
Operation Manual	You are redirected to the page for downloading this system manual.		sennheiser.com/D1-manual
FAQ & Support	You are redirected to the FAQ/support page.		sennheiser.com/D1-support
Mobile App	You are redirected to the page for downloading the app for your mobile device.		sennheiser.com/D1-app



- ▶ Use a QR scanner (e.g. your smartphone or a reading device for QR codes) to scan the QR code that appears on the receiver display panel or follow the given link in your browser. Alternatively, you can click on the desired link in the above table.

Retrieving system information

You can display the serial number and the current firmware version of the receiver.



- ▶ Select **System Settings – System Info**. The serial number as well as the version number and the date of the current firmware are displayed.
- ▶ Press the **ESC** button to return to the operating menu.

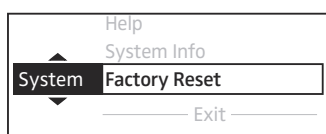

Resetting the receiver to the factory default settings

The **System Settings – Factory Reset** menu item allows you to reset the receiver to its factory default settings.

After the reset, the receiver is restarted and the standard display is shown on the display panel.

Changing the network configuration

i If you change a setting in the **Mode**, **IP**, **Subnet** and **Gateway** sub-menus of the **Network Settings** menu, you will be prompted to restart the receiver.

- ▶ Switch the receiver off and on again so that changes to the network configuration take effect.

Changing the IP address assignment mode

You can choose between static and dynamic IP address assignment.



- ▶ Select **Network Settings – Mode**.

Setting	Meaning
Fixed IP	The receiver is assigned a static IP address. You can enter the static IP address via the IP menu item.
Automatic	When switched on, the receiver is automatically assigned a dynamic IP address.

Changing the IP address

You can change the IP address of the receiver. The new IP address becomes effective only if **Fixed IP** has been selected in the **Mode** menu item.

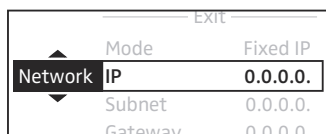

- ▶ Select **Network Settings – IP**.
- ▶ Enter the IP address.
- ▶ Select **Save** and confirm by pressing the jog dial.

Changing the subnet mask

You can change the subnet mask of the receiver.

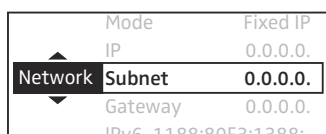

- ▶ Select **Network Settings – Subnet**.
- ▶ Enter the subnet mask.
- ▶ Select **Save** and confirm by pressing the jog dial.



Changing the gateway address

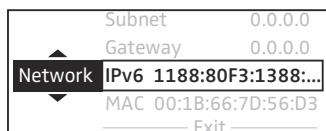
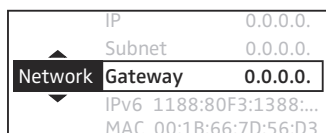

You can change the gateway of the receiver.

- ▶ Select **Network Settings – Gateway**.
- ▶ Enter the gateway address.
- ▶ Select **Save** and confirm by pressing the jog dial.

Displaying the IPv6 address

- ▶ Select **Network Settings – IPv6**.
The IPv6 address is displayed, but it cannot be changed.
- ▶ Press the **ESC** button to return to the operating menu.

Displaying the MAC address

- ▶ Select **Network Settings – MAC**.
The MAC address is displayed, but it cannot be changed.
- ▶ Press the **ESC** button to return to the operating menu.

Performing a walk test (checking the reception quality)

The **Walk Test** menu item allows you to check the reception quality of your radio links within the operating environment. By performing a walk test, you can verify the range and coverage of the radio links.

- ▶ Switch on the transmitters and receivers of all radio links that you want to use. In addition, switch on all other devices that you want to use in the operating environment.
- ▶ Select **Walk Test** on all receivers that you want to use for the walk test.
The RF signal level display appears on the display panel of both the receiver and the transmitter.
- ▶ Walk the operating environment with one or several paired transmitters.
The RF signal level display on the display panel of both the receiver and the transmitter is continuously updated.
- ▶ Check the RF signal level display for more detailed information on the reception quality:
 - Good reception quality is indicated by a tick (✓).
 - If the tick is missing, reception quality is sufficient.
 - If reception quality is or was compromised at any position, this is indicated by a warning triangle (⚠). The warning triangle remains displayed on the display panel even if reception quality improves afterwards.
 - If reception fails completely, the background of the display panel changes back and forth between light and dark and **No Link** ⚠ appears on the display panel.
- ▶ Press the **ESC** button on the receiver to end the walk test.

i If the result of the walk test is not satisfying, you can take the following remedial measures:

- If possible, reposition the receivers so that there is always a direct line of sight between the receiving antennas and the paired transmitter.
- If possible, remove obstacles between the transmitter and the receiving antennas.
- When rack-mounting receivers, you should mount their SG4 rod antennas to the front of the rack using the GA 4 rack-mount kit.



Controlling, monitoring or updating devices via the network



You can control, monitor and update multiple receivers and their paired transmitters via the network.



“WSR” app Together with the “Wireless System Remote” (WSR) app, you can use one or several mobile devices to remotely configure all receivers and transmitters of a multi-channel system, to monitor their operation, or to update the firmware of the devices.

“Sennheiser D1 SL Updater” software You can use the “Sennheiser D1 SL Updater” software to update the firmware.

Monitoring devices using the “WSR” app

The free “Wireless System Remote” (WSR) app is available in the Apple App Store or the Google Play Store.

Compatible mobile devices and operating systems:

- Apple iPad 2, iPad Air, iPad Air 2, iPad mini, iPad mini 2 or iPad mini 3 Apple iPhone 4, 4S, 5, 5S, 5C, 6, 6 Plus with iOS 6 or higher
- Tablets or mobile phones with Android version 2.3 or higher

i Devices with old hardware may not offer a smooth and fast user experience due to their limited processing power.

To control, monitor and update your receivers and transmitters using mobile devices:

- ▶ Connect all receivers to a WiFi router as described on page 20.



- ▶ Use a dual-band WiFi router and deactivate its 2.4 GHz frequency band in order to minimize interference to the radio links.
- ▶ Connect your mobile devices to the WiFi network and install the “Wireless System Remote” (WSR) app.
All functions that can be performed directly from the receiver can also be controlled via the app.



When started, the “WSR” app automatically checks for newer firmware. You can update both the receiver firmware and the transmitter firmware (see next chapter).

Performing firmware updates

ATTENTION

Breakdown of radio links during the firmware update

All radio links are subject to interference during the firmware update process and can therefore not be used for audio transmission.

- ▶ Never update the firmware during a performance.
- ▶ Never update the firmware of several transmitters simultaneously.

Breakdown of multi-channel systems due to different firmware versions

All transmitters and receivers of a multi-channel system must run the same firmware version.

- ▶ Always update all your transmitters and receivers to the latest firmware version available.

You can either use the “Wireless System Remote” (WSR) app or the “Sennheiser D1 SL Updater” software to update the firmware. Both the app and the software can be downloaded free of charge.

The app and the software automatically detect all receivers in the network, read their firmware version and offer to update the firmware if a newer version is available.



You can also display the current firmware version of a receiver via the **System Info** menu item – without the need for the “WSR” app or the “Sennheiser D1 SL Updater” software.

Preparing the firmware update

- ▶ Make sure that all receivers are connected in a network as described on page 20 and that all receivers are switched on.
- ▶ Switch off all transmitters.
You first update the firmware of the receivers via the network. Then you update the firmware of the transmitters via the radio links.

Updating the receiver firmware using the “WSR” app

To update the firmware using the “WSR” app:

- ▶ Make sure that your mobile device has Internet access so that you can download the firmware file.
- ▶ Start the app.
When started, the app automatically checks for newer firmware.



- ▶ Open the **Device** tab.

The app automatically detects all receivers in the network and reads their settings and firmware version.

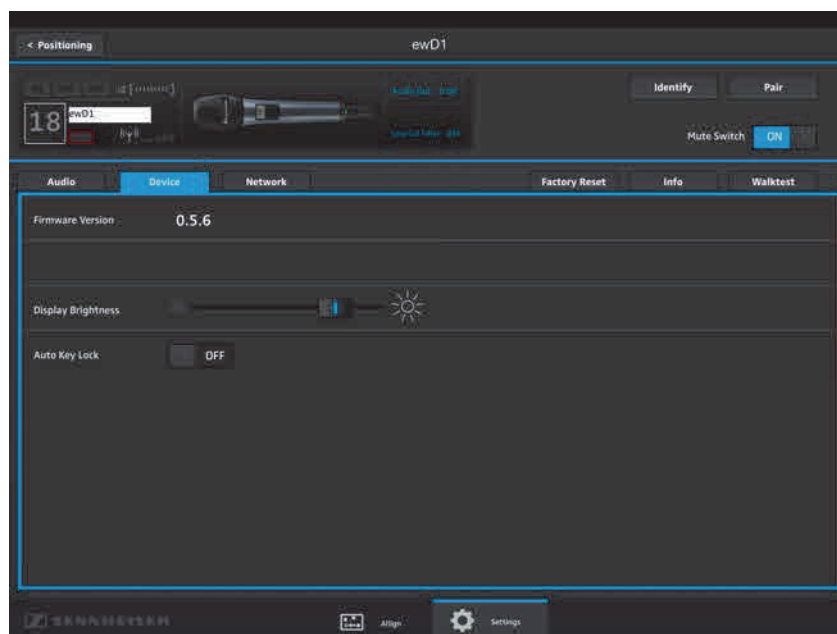

If a newer firmware is available, **Update Available** appears on the screen and the **Update** button becomes active. If the firmware is up-to-date, **Current** is shown instead.

- ▶ Tap on the **Update** button.

A progress bar appears on the receiver display panel while the new firmware is being downloaded and transferred to the receiver via the network. Then **Finalising** and a new progress bar appear on the receiver display panel while the firmware is being installed. Finally, the receiver restarts. The app displays the new firmware version. **Update Available** and the **Update** button disappear from the screen.

i You can update the firmware of several receivers simultaneously by simply going to the next receiver in the app and then tapping the **Update** button on the **Device** tab.

Updating the receiver firmware using the “Sennheiser D1 SL Updater” software

To update the firmware using the “Sennheiser D1 SL Updater” software:

- ▶ Connect all receivers to a router or switch as described on page 20.
- ▶ Use an Ethernet cable to connect a computer to this router or switch. The connected computer requires Windows 7 or higher (32 or 64 bit) and Internet access.

i If Internet access cannot be guaranteed at all times and in all locations:

- ▶ Download the firmware file in advance via the Sennheiser [Downloadarea](#) and save it, for example, on a USB flash drive.
- ▶ Install the “Sennheiser D1 SL Updater” software on the computer. The software can be downloaded from the following URL: www.sennheiser.com/D1-app.
- ▶ Start the software.
The software automatically detects all receivers in the network and reads their firmware version.



If you cannot access the Internet:

- ▶ Click **Browse** and navigate to the firmware file you saved.

The software displays the receiver information in list form.

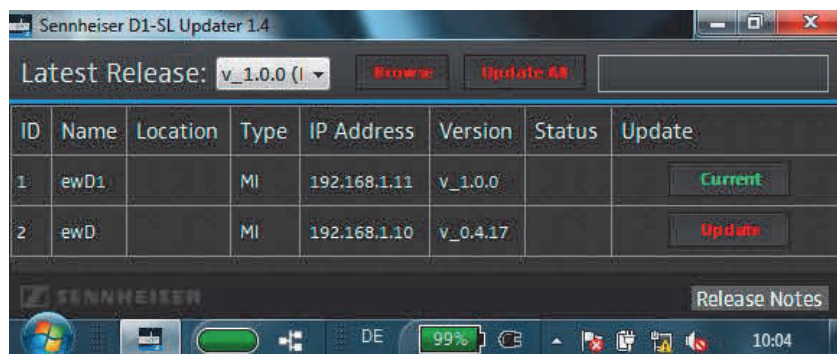

If a newer firmware is available, its version number appears in the **Latest Release** drop-down list. In addition, the buttons **Update All** and **Update** become active (see the second table row in the above screen shot). If the firmware is up-to-date, the text **Current** is shown instead (see the first table row in the above screen shot).

To update the firmware of all receivers:

- ▶ Click the **Update All** button located above the table.

To update the firmware of individual receivers:

- ▶ Click **Update** in the corresponding table row.

A progress bar appears on the receiver display panels while the new firmware is being downloaded and transferred to the receivers via the network. Then **Finalising** and a new progress bar appear on the receiver display panels while the firmware is being installed. Finally, the receivers restart. The table displays the new firmware version and the text **Current**.

Updating the transmitter firmware

Once you have updated the firmware of all receivers:

- ▶ Switch on a transmitter. All other transmitters must be switched off during the firmware update!

The paired receiver automatically detects the differing firmware version of the transmitter. A message appears on the receiver display panel prompting you to update the firmware of the transmitter.

- ▶ Update the transmitter firmware by selecting **OK** and then confirming by pressing the jog dial.

The status LED on both the transmitter and the receiver lights up yellow and **Remote Update** appears on the transmitter display panel while the firmware is being wirelessly transmitted from the receiver to the transmitter and automatically installed.



- ▶ Wait until the transmitter has restarted and the status LED on both the transmitter and the receiver lights up green.

The firmware update was successful.

- ▶ Switch off the transmitter with the updated firmware and repeat the update procedure with the next transmitter.





Cleaning and maintaining the products

Important safety instructions

ATTENTION

Liquids can damage the electronics of the devices

Liquids entering the housing of the devices can cause a short-circuit and damage the electronics.

- ▶ Only clean the devices with a soft, dry cloth.

ATTENTION

Damage to the surfaces of the devices

Solvents or cleansing agents can damage the surfaces of the devices.

- ▶ Do not use any solvents or cleansing agents.
- ▶ Use devices that are frequently worn on the body so that direct skin contact and contact with sweat is avoided.
- ▶ Use a dry cloth to clean all devices that are frequently worn on the body from time to time.

Cleaning and maintaining the receiver

If a display is left uninterrupted on the receiver's display panel for extended periods of time, this "static" display will wear itself into the display panel (a phenomenon known as image persistence or burn in). To prevent image persistence, the display panel dims automatically a few minutes after the last button press.

- ▶ When not using the receiver for extended periods of time, switch it off in order to further reduce the risk of image persistence and to keep current consumption low.
- ▶ Disconnect the device from the power supply system before cleaning.

Cleaning the sound inlet basket of the handheld transmitter

- ▶ Unscrew the sound inlet basket from the handheld transmitter.

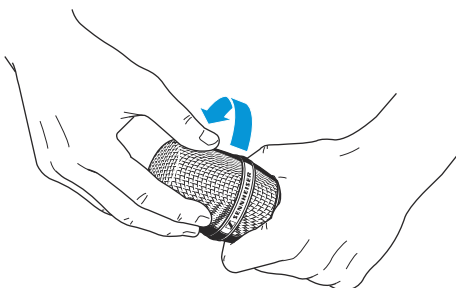
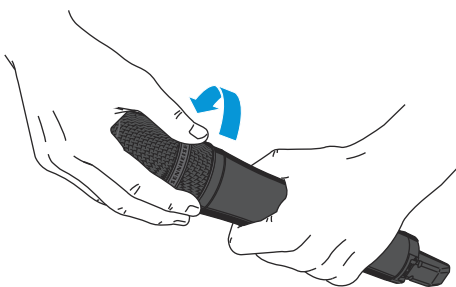

- ▶ Unscrew the upper part of the sound inlet basket from the lower part.

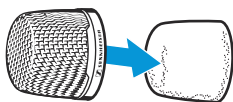



- ▶ Remove the foam insert from the upper part of the sound inlet basket.
- ▶ Use a dry cloth to clean the upper part of the sound inlet basket from the inside and outside.
- ▶ Reinsert the foam insert into the upper part of the sound inlet basket.
- ▶ Screw the upper part of the sound inlet basket back to the lower part.
- ▶ Replace the sound inlet basket on the handheld transmitter and screw it tight.



If a problem occurs ...

Troubleshooting

Problem	Possible cause	Possible solution	Page
No sound	The receiver is not connected properly.	Connect the receiver properly.	16
	The amplifier or mixing console is not connected, not switched on or adjusted to a too low volume.	Refer to the instruction manual of the amplifier or mixing console.	
	The transmitter is muted. Muted  appears on the display panel and the status LED lights up yellow.	Set the MUTE switch to the position MIC.	28
	The transmitter and the receiver are not paired.	Perform device identification. Pair the devices properly.	29 28
	The transmitter's batteries are flat or the accupack is flat.	Insert new batteries. Recharge the accupack.	22, 24 25
Sound too low	The volume of the amplifier or mixing console is adjusted to low.	Refer to the instruction manual of the amplifier or mixing console.	
	The receiver's output level is adjusted too low.	Increase the receiver's audio level via the Audio Level menu item.	34
	The receiver's output level is set to Mic but the receiver is connected to a wrong input.	Connect the receiver to the mic input of the mixing console or set the receiver's output level to Line .	34
Bad reception	The distance between the transmitter and the receiving antennas is too high.	Reduce the distance between the transmitter and the receiving antennas and make sure that there is a direct line of sight between the transmitter and the receiving antennas.	15
	The antennas are not properly connected or optimally positioned.	Check the antenna cables or the antennas and reposition the antennas.	15, 16
Receiver does not react to any button press	The lock mode is activated. Locked  appears on the display panel.	Deactivate the lock mode.	34
The devices take a very long time to establish a radio link	The devices need more time to establish the radio links because a multi-channel system is being put into operation for the first time.	Refer to the enclosed "Multichannel Operation" leaflet.	29
	The devices need more time to establish the radio links because there are active interfering sources in the vicinity of the devices.	Move paired transmitters closer to the receiving antennas and deactivate sources of interference such as WiFi and Bluetooth.	15



Reacting to messages displayed on the display panel

Message ¹	Possible cause	Possible solution	Page
No link	No radio link can be established. The transmitter is switched off or out of range.	<ul style="list-style-type: none"> Switch the transmitter on. Keep a free line of sight between the transmitter and the receiver and reduce the distance between the devices. Hold the handheld transmitter correctly. Use the Walk Test menu item to check the reception quality and avoid areas without reception. 	26 15 24 37
Bad link	The received radio signal is very weak or of bad quality.	<ul style="list-style-type: none"> Keep a free line of sight between the transmitter and the receiver and reduce the distance between the devices. Hold the handheld transmitter correctly. Use the Walk Test menu item to check the reception quality and avoid areas with bad reception. 	15 24 37
Low battery	The batteries or the accupack of the received transmitter are/is flat.	<ul style="list-style-type: none"> Insert new batteries. Recharge the accupack. 	22 25
Mute disabled	The transmitter cannot be muted because the MUTE switch is deactivated.	Activate the MUTE switch.	35
Muted	The transmitter is muted.	Set the MUTE switch to the position MIC .	28

¹ In addition, the background of the display panel changes back and forth between light and dark.

If a problem occurs that is not listed in the tables or if the problem cannot be solved with the proposed solutions, please contact your local Sennheiser partner for assistance. To find a Sennheiser partner in your country, search at www.sennheiser.com under "Service & Support".



Specifications

System

AF frequency response	20 to 20,000 Hz
Dynamic range	> 128 dB (A)
THD	typ. 0.1 % (1 kHz, 6 dB below max. audio output level)
Audio sampling	24 bit/48 kHz
Signal-to-noise ratio	typ. 109 dB (A)
RF frequency ranges	2,400 to 2,483.5 MHz
Modulation	GFSK with back channel
Transmission method	TDMA, time diversity, frequency diversity, fast switching antenna diversity
Latency	3.9 ms
Audio codec	aptX® Live
Relative air humidity	max. 95 %
Temperature range*	
Operation:	-10 °C to +55 °C
Storage:	-20 °C to +70 °C

* The temperature range is influenced by the battery characteristics

EM D1



RF sensitivity	< -90 dBm
RF output power back channel	10 mW/100 mW (country-specific)
Audio output level gain	
Mic/line level switch:	-12 dB/0 dB
XLR, balanced:	max +18 dBu
Jack, unbalanced/bal- anced:	max. +12 dBu/max. +18 dBu
Audio effects	
Low cut:	at 120 Hz
Equalizer:	7-band graphic equalizer
De-esser:	multi-frequency targets
Automatic Gain Control (AGC):	compression/expansion with automatic make- up gain function
Display	OLED
AF connection sockets	XLR/1/4" (6.3 mm) jack
Antenna sockets	2 x R-SMA
Network socket	RJ45
Network protocol	Media Control Protocol, UDP IPv4 (DHCP, Manual)/IPv6
Power supply	12 V DC hollow jack
Current consumption	350 mA
Weight	approx. 824 g

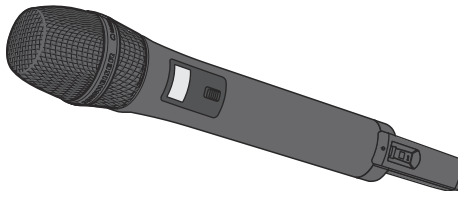

SKM D1 and SKM-S D1

RF output power	adaptive, up to 100 mW or 10 mW (country-specific)
AF frequency response	50 to 20,000 Hz
Input sensitivity	automatic sensitivity adjustment
Power supply	
Batteries:	2 x AA size battery (1.5 V)
Accupack*:	BA 10 (Li-Ion, 3.6 V)
Operating time	
Batteries:	typ. 6 h
Accupack*:	typ. 11 h
Display	LCD
Weight (w/o batteries)	approx. 280 g incl. microphone head

* optional accessory

SK D1

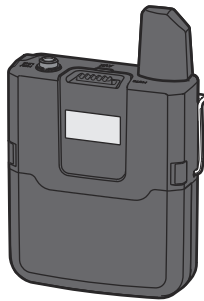

RF output power	adaptive, up to 100 mW or 10 mW (country-specific)
AF frequency response	
Mic:	50 to 20,000 Hz
Line:	20 to 20,000 Hz
Max. input level	
Mic:	2.2 V RMS
Line:	3.3 V RMS
Line input impedance	1 MΩ
Input sensitivity	automatic sensitivity adjustment
Power supply	
Batteries:	2 x AA size battery (1.5 V)
Accupack*:	BA 30 (Li-Ion, 3.7 V)
Operating time	
Batteries:	typ. 6 h
Accupack*:	typ. 11 h
AF connection socket	3.5 mm jack socket, lockable Connector assignment:

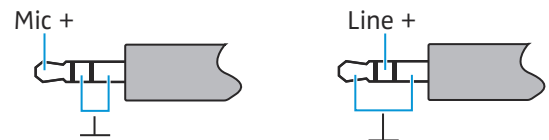

Weight (w/o batteries)	approx. 85 g
------------------------	--------------

* optional accessory



Microphones



MMD 835-1 Microphone type
Sensitivity
Pick-up pattern
Max. SPL

dynamic
2.1 mV/Pa
cardioid
154 dB SPL

MMD 845-1 Microphone type
Sensitivity
Pick-up pattern
Max. SPL

dynamic
1.6 mV/Pa
super-cardioid
154 dB SPL

MMD 935-1 Microphone type
Sensitivity
Pick-up pattern
Max. SPL

dynamic
2.5 mV/Pa
cardioid
130 dB SPL

MMD 945-1 Microphone type
Sensitivity
Pick-up pattern
Max. SPL

dynamic
1.8 mV/Pa
super-cardioid
150 dB SPL



ME 2-2 Microphone type
Sensitivity
Pick-up pattern
Max. SPL

pre-polarized condenser microphone
20 mV/Pa
omni-directional
130 dB SPL

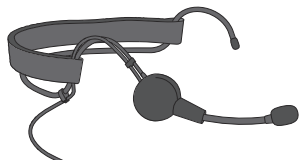

ME 3-II Microphone type
Sensitivity
Pick-up pattern
Max. SPL

pre-polarized condenser microphone
1.6 mV/Pa
cardioid
150 dB SPL

In compliance with:

Europe



Radio EN 300328
EMC EN 301489-1/-17
Safety EN 60950-1
EN 62311 (SAR)
RoHS EN 50581
FCC 47 CFR 15
Industry Canada RSS 210
CAN ICES-3(B)/NMB-3(B)

USA

Canada

Approved by:

USA

EM

SKM

SK

Canada

EM

SKM

SK

Australia/New Zealand

Japan

FCC ID: DMOEM2G4WE
FCC ID: DMOSKM2G4WE
FCC ID: DMOSK2G4WE

IC: 2099A-EM2G4WE
IC: 2099A-SKM2G4WE
IC: 2099A-SK2G4WE



EM R 202-SMC048
SKM R 202-SMC049
SK R 202-SMC050



Power supply units

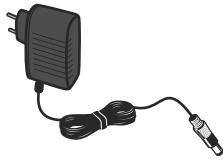

NT 12-4C

Nominal input voltage	100 to 240 V~
Power frequency	50 or 60 Hz
Input current	max. 120 mA
Nominal output voltage	12 V
Standby power consumption	≤ 0.3 W
Energy efficiency level	V
Operating temperature	-10 °C to +55 °C
Storage temperature	-20 °C to +70 °C
Relative air humidity	max. 95 %
Weight	approx. 100 g

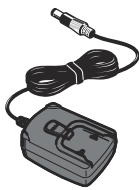

NT 2-3

Nominal input voltage	100 to 240 V~
Power frequency	50 or 60 Hz
Input current	max. 120 mA
Nominal output voltage	12 V
Standby power consumption	≤ 0.3 W
Energy efficiency level	IV
Operating temperature	-10 °C to +55 °C
Storage temperature	-20 °C to +70 °C
Relative air humidity	max. 95 %
Weight	approx. 105 g

In compliance with:

Europe



EMC	EN 55022 EN 55024
Safety	EN 60065
RoHs	EN 50581
Commission Regulation (EC) No. 1275/2008	

USA/Canada

EMC	FCC 47 CFR 15 B ICES 003 CAN ICES-3(B)/NMB-3(B)
Safety	UL 60065 CAN/CSA-C22.2 No. 60065

China

EMC	GB13837 GB17625
Safety	GB8898
RoHs	

Australia/New Zealand

EMC	AS/NZS CISPR 22
Safety	AS/NZS 60065

Certified by:

Europe

VDF_GS (T2-3)
ENEC 22 SIQ (NZ12-4)

USA/Canada



Australia/New Zealand



Japan



China





Korea



KTL SU 10524-13002
(NT 2-3 only)

Russia



Optional accupacks

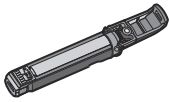

BA 10

Charging capacity
Output voltage

2,200 mAh
3.6 V



BA 30

Charging capacity
Output voltage

2,030 mAh
3.7 V

In compliance with:

Europe



EMC EN 301489-1/-6/-17
Safety IEC/EN 62133

USA/Canada

Rechargeable
battery cells UL 1642
Accupack UL 2054

Japan

DENAN Ordinance Article 1;
Appendix 9 Lithium Ion

Korea

Safety K 62133

UN transportation test

according to UN Manual of Tests and Criteria,
Part III,
section 38.3 Lithium-Ion batteries

Certified by:

USA/Canada



Japan



ゼンハイザージャパン(株)

Korea



Dimensions

Receiver

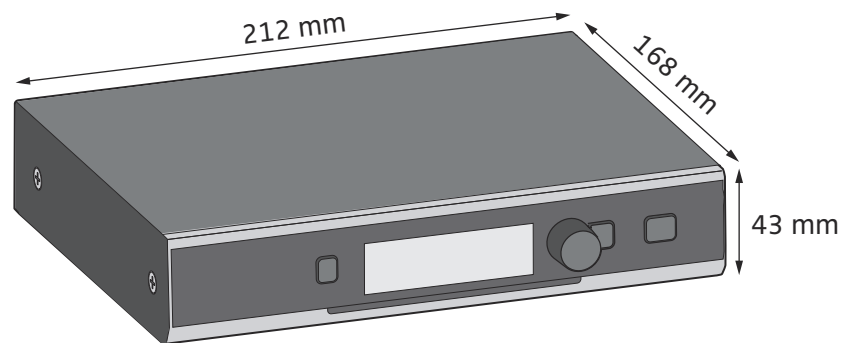

Handheld transmitter

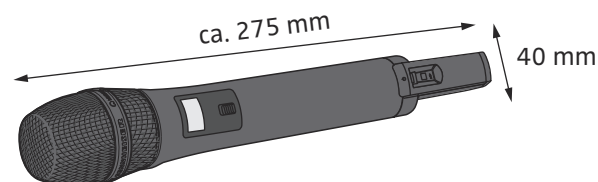



Bodypack transmitter

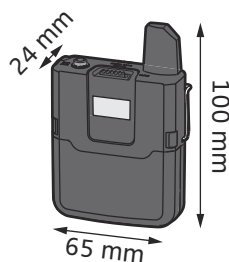

Licenses

CSR - aptX® Live Codec

aptX® Live, which is used in this microphone, is provided by CSR.

Designed specifically for digital wireless microphones, aptX® Live delivers exceptional acoustic quality with a dynamic range in excess of 120 dB and a coding delay of under 2 ms. This unparalleled delay enables the wireless streaming of digital audio in real time and removes any lip synchronization issues.

The aptX® Live audio codec also employs connection, synchronization, and error reduction techniques to ensure a solid and professional wireless link.

Modified BSD licenses

Copyright (c) 2001, 2002, 2003, 2004 Swedish Institute of Computer Science

Copyright (c) 2001, 2002, 2003, 2004 Leon Woestenberg <leon.woestenberg@axon.tv>

Copyright (c) 2001, 2002, 2003, 2004 Axon Digital Design B.V., The Netherlands.

Copyright (c) 1990 The Regents of the University of California

Copyright (c) 1990, 1992, 1993 The Regents of the University of California

Copyright (c) 1988 Regents of the University of California

All rights reserved.

Redistribution and use in source and binary forms, with or without modification, are permitted provided that the following conditions are met:

1. Redistributions of source code must retain the above copyright notice, this list of conditions and the following disclaimer.
2. Redistributions in binary form must reproduce the above copyright notice, this list of conditions and the following disclaimer in the documentation and/or other materials provided with the distribution.
3. Neither the name of the copyright holder nor the names of its contributors may be used to endorse or promote products derived from this software without specific prior written permission.

THIS SOFTWARE IS PROVIDED BY THE COPYRIGHT HOLDERS AND CONTRIBUTORS "AS IS" AND ANY EXPRESS OR IMPLIED WARRANTIES, INCLUDING, BUT NOT LIMITED TO, THE IMPLIED WARRANTIES OF MERCHANTABILITY AND FITNESS FOR A PARTICULAR PURPOSE ARE DISCLAIMED. IN NO EVENT SHALL THE COPYRIGHT HOLDER OR CONTRIBUTORS BE LIABLE FOR ANY DIRECT, INDIRECT, INCIDENTAL, SPECIAL, EXEMPLARY, OR CONSEQUENTIAL DAMAGES (INCLUDING, BUT NOT LIMITED TO, PROCUREMENT OF SUBSTITUTE GOODS OR SERVICES; LOSS OF USE, DATA, OR PROFITS; OR BUSINESS INTERRUPTION) HOWEVER CAUSED AND ON ANY THEORY OF LIABILITY, WHETHER IN CONTRACT, STRICT LIABILITY,



OR TORT (INCLUDING NEGLIGENCE OR OTHERWISE) ARISING IN ANY WAY OUT OF THE USE OF THIS SOFTWARE, EVEN IF ADVISED OF THE POSSIBILITY OF SUCH DAMAGE.

GNU GPL version 2

To obtain the source code of software components licensed under the GPL v2, please submit a written request to us. Our contact data can be found on the back page of the Specifications booklet.

Ubuntu Font License

Version 1.0

Preamble

This license allows the licensed fonts to be used, studied, modified and redistributed freely. The fonts, including any derivative works, can be bundled, embedded, and redistributed provided the terms of this license are met. The fonts and derivatives, however, cannot be released under any other license. The requirement for fonts to remain under this license does not require any document created using the fonts or their derivatives to be published under this license, as long as the primary purpose of the document is not to be a vehicle for the distribution of the fonts.

Permission & Conditions

This license does not grant any rights under trademark law and all such rights are reserved.

Permission is hereby granted, free of charge, to any person obtaining a copy of the Font Software, to propagate the Font Software, subject to the below conditions:

1. Each copy of the Font Software must contain the above copyright notice and this license. These can be included either as stand-alone text files, human-readable headers or in the appropriate machine-readable metadata fields within text or binary files as long as those fields can be easily viewed by the user.
2. The font name complies with the following:
 1. The Original Version must retain its name, unmodified.
 2. Modified Versions which are Substantially Changed must be renamed to avoid use of the name of the Original Version or similar names entirely.
 3. Modified Versions which are not Substantially Changed must be renamed to both
 1. retain the name of the Original Version and
 2. add additional naming elements to distinguish the Modified Version from the Original Version. The name of such Modified Versions must be the name of the Original Version, with "derivative X" where X represents the name of the new work, appended to that name.
3. The name(s) of the Copyright Holder(s) and any contributor to the Font Software shall not be used to promote, endorse or advertise any Modified Version, except
 1. as required by this license,
 2. to acknowledge the contribution(s) of the Copyright Holder(s) or
 3. with their explicit written permission.



4. The Font Software, modified or unmodified, in part or in whole, must be distributed entirely under this license, and must not be distributed under any other license. The requirement for fonts to remain under this license does not affect any document created using the Font Software, except any version of the Font Software extracted from a document created using the Font Software may only be distributed under this license.

Termination

This license becomes null and void if any of the above conditions are not met.

Disclaimer

THE FONT SOFTWARE IS PROVIDED "AS IS", WITHOUT WARRANTY OF ANY KIND, EXPRESS OR IMPLIED, INCLUDING BUT NOT LIMITED TO ANY WARRANTIES OF MERCHANTABILITY, FITNESS FOR A PARTICULAR PURPOSE AND NONINFRINGEMENT OF COPYRIGHT, PATENT, TRADEMARK, OR OTHER RIGHT. IN NO EVENT SHALL THE COPYRIGHT HOLDER BE LIABLE FOR ANY CLAIM, DAMAGES OR OTHER LIABILITY, INCLUDING ANY GENERAL, SPECIAL, INDIRECT, INCIDENTAL, OR CONSEQUENTIAL DAMAGES, WHETHER IN AN ACTION OF CONTRACT, TORT OR OTHERWISE, ARISING FROM, OUT OF THE USE OR INABILITY TO USE THE FONT SOFTWARE OR FROM OTHER DEALINGS IN THE FONT SOFTWARE.

Accessories

Receiver

- EM D1 rack receiver
incl. NT 2-3 or NT 12-4C power supply unit
incl. GA 4 rack-mount kit

Mounting accessories for the receiver

- GA 4 rack-mount kit

Connection cable

- CI 1 guitar cable

Transmitters

- SK D1 bodypack transmitter
incl. 2 AA size batteries (1.5 V) and B 30 battery box
- SKM D1 handheld transmitter without mute switch
without microphone head
incl. 2 AA size batteries (1.5 V) and B 10 battery box
- SKM-S D1 handheld transmitter with mute switch
without microphone head
incl. 2 AA size batteries (1.5 V) and B 10 battery box

Microphones for the bodypack transmitter

- ME 2-2 clip-on microphone
- ME 3-II headset microphone

Microphone heads for the handheld transmitter

- MMD 835, dynamic, cardioid
- MMD 845, dynamic, super-cardioid
- MMD 935, dynamic, cardioid
- MMD 945, dynamic, super-cardioid
- MMK 965, pre-polarized condenser, super-cardioid
- MMK 965, large diaphragm true condenser microphone with switchable pick-up pattern (super-cardioid/cardioid)

Windshields

- MZW 1 windshield for the handheld transmitter

Power supply units

- NT 2-3 power supply unit for the receiver
- Interchangeable country adapters for the NT 2-3 power supply unit
- NT 12-4C power supply unit for the receiver
- NT 5-10-U USB power supply/charger for the accupack

Battery boxes and optional accupacks

- B 10 battery box for the handheld transmitter
- B 30 battery box for the bodypack transmitter
- BA 10 accupack for the handheld transmitter
- BA 30 accupack for the bodypack transmitter

Protective case

- Transport case for the systems

Manufacturer Declarations

Warranty

- Sennheiser electronic GmbH & Co. KG gives a warranty of 24 months on the products of the Sennheiser evolution wireless D1 system.
- For the current warranty conditions, please visit our website at www.sennheiser.com or contact your Sennheiser partner.

FOR AUSTRALIA ONLY

Sennheiser goods come with guarantees that cannot be excluded under the Australian Consumer Law. You are entitled to a replacement or refund for a major failure and compensation for any other reasonably foreseeable loss or damage. You are also entitled to have the goods repaired or replaced if the goods fail to be of acceptable quality and the failure does not amount to a major failure.

This warranty is in addition to other rights or remedies under law. Nothing in this warranty excludes, limits or modifies any liability of Sennheiser which is imposed by law, or limits or modifies any remedy available to the consumer which is granted by law.

To make a claim under this warranty, contact Sennheiser Australia Pty Ltd, Unit 3, 31 Gibbes Street Chatswood NSW 2067, Australia; Phone: (02) 9910 6700, email: service@sennheiser.com.au

All expenses of claiming the warranty will be borne by the person making the claim.

The Sennheiser International Warranty is provided by Sennheiser Australia Pty Ltd (ABN 68 165 388 312), Unit 3, 31 Gibbes Street Chatswood NSW 2067, Australia.

In compliance with the following requirements



- WEEE Directive (2012/19/EC)
Please dispose of the products at the end of their operational lifetime by taking them to your local collection point or recycling center for such equipment.
- Battery Directive (2006/66/EC)
The supplied rechargeable batteries or batteries must be recycled. Please dispose of them as special waste or return them to your specialist dealer. In order to protect the environment, only dispose of exhausted batteries or rechargeable batteries.

CE Conformity

- CE 0682
- R&TTE Directive (1999/5/EC)
- RoHS Directive (2011/65/EU)
- EMC Directive (2004/108/EC)
- Low Voltage Directive (2006/95/EU)

The declarations are available at www.sennheiser.com. Before putting the products into operation, please observe the respective country-specific regulations.

FCC

Radiofrequency radiation exposure information:

This equipment complies with FCC and IC radiation exposure limits set forth for an uncontrolled environment. The EM D1 should be installed and operated with a minimum distance of 20 cm between the radiator and your body.

These devices must not be co-located or operated in conjunction with any other antenna or transmitter.

These devices comply with Part 15 of the FCC Rules and with Industry Canada licence-exempt RSS standard(s).

Operation is subject to the following two conditions:

- (1) this device may not cause harmful interference, and
- (2) this device must accept any interference received, including interference that may cause undesired operation.

NOTICE:

Changes or modifications made to this equipment not expressly approved by Sennheiser Electronic Corporation may void the FCC authorization to operate this equipment.

NOTE: This equipment has been tested and found to comply with the limits for a Class B digital device, pursuant to Part 15 of the FCC Rules. These limits are designed to provide reasonable protection against harmful interference in a residential installation. This equipment generates, uses and can radiate radio frequency energy and, if not installed and used in accordance with the instructions, may cause harmful interference to radio communications. However, there is no guarantee that interference will not occur in a particular installation. If this equipment does cause harmful interference to radio or television reception, which can be determined by turning the equipment off and on, the user is encouraged to try to correct the interference by one or more of the following measures:

- Reorient or relocate the receiving antenna.
- Increase the separation between the equipment and receiver.
- Connect the equipment into an outlet on a circuit different from that to which the receiver is connected.
- Consult the dealer or an experienced radio/TV technician for help.

These class B digital devices comply with the Canadian ICES-003.



Sennheiser electronic GmbH & Co. KG

Am Labor 1, 30900 Wedemark, Germany
www.sennheiser.com

Publ. 06/15, 560086/A01