

# UAD POWERED PLUG-INS

## USER MANUAL

**VERSION 5.0**

MANUAL VERSION 080819

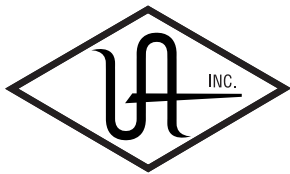

UNIVERSAL AUDIO

Universal Audio, Inc.  
1700 Green Hills Road  
Scotts Valley, CA 95066-4926  
Voice: +1-831-440-1176  
Fax: +1-831-461-1550  
[www.uaudio.com](http://www.uaudio.com)

Customer Support (USA):  
1-877-MY-UAUDIO (877-698-2834)

# NOTICES

## Disclaimer

This manual provides general information, preparation for use, installation and operating instructions for the Universal Audio UAD Powered Plug-Ins. The information contained in this manual is subject to change without notice.

Universal Audio, Inc. makes no warranties of any kind with regard to this manual, or the product(s) it refers to, including, but not limited to, the implied warranties of merchantability and fitness for a particular purpose.

Universal Audio, Inc. shall not be liable for errors contained herein or direct, indirect, special, incidental, or consequential damages in connection with the furnishing, performance, or use of this material or the product(s).

## Important Safety Instructions

Before using this unit, be sure to carefully read the applicable items of these operating instructions and the safety suggestions. Afterwards keep them handy for future reference. Take special care to follow the warnings indicated on the unit, as well as in the operating instructions.

### Water and Moisture

Do not use the unit near any source of water or in excessively moist environments.

### Object and Liquid Entry

Care should be taken so that objects do not fall, and liquids are not spilled, into the enclosure through openings.

### Ventilation

When installing the unit in a rack or any other location, be sure there is adequate ventilation. Improper ventilation will cause overheating, and can damage the unit.

### Heat

The unit should be situated away from heat sources, or other equipment that produces heat.

### Power Sources

The unit should be connected to a power supply only of the type described in the operating instructions, or as marked on the unit.

### Power Cord Protection

AC power supply cords should be routed so that they are not likely to be walked on or pinched by items placed upon or against them. Pay particular attention to cords at plugs, convenience receptacles, and the point where they exit from the unit. Never take hold of the plug or cord if your hand is wet. Always grasp the plug body when connecting or disconnecting AC.

### Cleaning

The external unit should be cleaned only with a damp cloth and mild soap if necessary. Chemical cleaners may damage the silkscreen and/or finish.

### Nonuse Periods

The AC power supply cord of the unit should be unplugged from the AC outlet when left unused for a long period of time.

### Damage Requiring Service

The unit should be serviced by qualified service personnel when:

- The AC power supply cord or the plug has been damaged;
- Objects have fallen or liquid has been spilled into the unit;
- The unit has been exposed to rain;
- The unit does not operate normally or exhibits a marked change in performance;
- The unit has been dropped, or the enclosure damaged.

## Servicing

The user should not attempt to service the unit beyond that described in the operating instructions. All other servicing should be referred to qualified service personnel.

## FCC Compliance

This equipment has been tested and found to comply with the limits for a Class B digital device, pursuant to part 15 of the FCC Rules. These limits are designed to provide reasonable protection against harmful interference in a residential installation.

This equipment generates, uses and can radiate radio frequency energy and, if not installed and used in accordance with the instructions, may cause harmful interference to radio communications. However, there is no guarantee that interference will not occur in a particular installation.

If this equipment does cause harmful interference to radio or television reception, which can be determined by turning the equipment off and on, the user is encouraged to try to correct the interference by one or more of the following measures:

- Reorient or relocate the receiving antenna.
- Increase the separation between the equipment and receiver.
- Connect the equipment into an outlet on a circuit different from that to which the receiver is connected.
- Consult the dealer or an experienced radio/TV technician for help.

Caution: Changes or modifications not expressly approved by Universal Audio could void the user's authority to operate the equipment.

## Copyright

Copyright © 2008 Universal Audio, Inc. All rights reserved.

This manual and any associated software, artwork, product designs, and design concepts are subject to copyright protection. No part of this document may be reproduced, in any form, without prior written permission of Universal Audio, Inc. Your rights to the software are governed by the accompanying End-User license agreement.

## Trademarks

Powered Plug-Ins, UAD, UAD-1, UAD-1e, UAD-2, Xpander, LA-2A, LA-3A, 1176, EX-1, DM-1, RS-1, CS-1 Channel Strip, RealVerb Pro, DreamVerb, Helios, Precision Mastering Series, Precision Mix Series and the Universal Audio, Inc. logo are trademarks of Universal Audio, Inc. Other company and product names mentioned herein are trademarks of their respective owners.

# Universal Audio, Inc.

## End-User License Agreement

### IMPORTANT - PLEASE READ THIS LICENSE AGREEMENT CAREFULLY BEFORE INSTALLING THIS SOFTWARE.

This Universal Audio, Inc. End-User License Agreement ("Agreement") is a legal agreement between you (either an individual or a single entity), as an end-user, and Universal Audio, Inc ("Universal Audio") for the software accompanying this Agreement, which includes computer software and any bug fixes subsequently delivered and associated media, printed materials and "online" or electronic documentation (collectively, the "Software"). The Software is licensed, not sold, by Universal Audio to the original end user for use only on the terms set forth here. By exercising your rights to install, copy and use the Software, you agree to be bound by these terms. If you do not agree to these terms, you may not install, copy or use the Software.

#### 1 Limited Use License.

Universal Audio, as Licensor, grants you, as Licensee, a non-exclusive license to use the Software with a single computer unit at a single location.

#### 2 Title.

The Software is owned by Universal Audio or its suppliers and is protected by copyright laws and international treaty provisions, as well as other intellectual property laws and treaties. Universal Audio retains title to and ownership of the Software and all copies thereof in any form. Universal Audio retains all rights in the Software not specifically granted to the Licensee. Nothing in this Agreement constitutes a waiver of Universal Audio's rights under United States copyright law or any other law.

#### 3 Permitted Use and Restrictions.

You may install the Software into the memory of a single computer, but may not electronically transfer the Software to someone else's computer or operate it in a time-sharing or service-bureau operation. You may make one copy of the Software for backup purposes only (and replacement backup copies in the event of loss of or damage to a backup copy), provided you include all copyright notices contained on the original media on the backup copy. You may not modify, translate, adapt, reverse engineer, decompile, create other works from, or disassemble the Software or any portions thereof. Similarly, you may not copy, modify, adapt, transfer, or create other works based upon the printed materials and "online" or electronic documentation accompanying or published for use with the Software (the "Documentation").

#### 4 Transfer.

You may not export, transfer, convey, rent, sublicense, or otherwise distribute the Software or any rights therein to any person or entity. Notwithstanding the foregoing, you may transfer this license to a transferee:

- (i) for whom you have provided registration details (your name, hardware ID(s), user e-mail ID, buyer's name and buyer's e-mail address) to Universal Audio at [info@uaudio.com](mailto:info@uaudio.com) in advance of such transfer; and
- (ii) who has agreed to be bound by the terms of this license by registering with Universal Audio at [my.uaudio.com](http://my.uaudio.com) and confirming such agreement during installation of the software. Any such permitted transferee may not subsequently transfer this license and the limited 90 day warranty set forth in the first two sentences of Section 5 shall expire upon such permitted transfer.

#### 5 Limited Warranty.

Universal Audio grants solely to you a limited warranty for a period of ninety (90) days from the original purchase date that the media on which the software is distributed shall be substantially free from material defects. Your exclusive remedy, at Universal Audio's option, is to return and have replaced the inaccurate media containing the software programs or receive a refund of the price paid within the warranty period. UNIVERSAL AUDIO DOES NOT WARRANT THAT THE SOFTWARE WILL MEET YOUR REQUIREMENTS OR THAT ITS OPERATION WILL BE UNINTERRUPTED OR ERROR-FREE. EXCEPT AS SPECIFIED HEREIN, UNIVERSAL AUDIO MAKES NO WARRANTIES OR REPRESENTATIONS, EXPRESS OR IMPLIED, REGARDING THE SOFTWARE, DOCUMENTATION, OR MEDIA, AND HEREBY EXPRESSLY DISCLAIMS THE WARRANTIES OF MERCHANTABILITY, FITNESS FOR A PARTICULAR PURPOSE, AND NON-INFRINGEMENT OF THIRD PARTY RIGHTS. FURTHERMORE, UNIVERSAL AUDIO DOES NOT WARRANT OR MAKE ANY REPRESENTATIONS REGARDING THE USE OR THE RESULTS OF THE USE OF THE SOFTWARE OR DOCUMENTATION IN TERMS OF THEIR CORRECTNESS, ACCURACY, RELIABILITY,

OR OTHERWISE. NO ORAL OR WRITTEN INFORMATION OR ADVICE GIVEN BY UNIVERSAL AUDIO OR A UNIVERSAL AUDIO-AUTHORIZED REPRESENTATIVE SHALL CREATE A WARRANTY OR IN ANY WAY INCREASE THE SCOPE OF THIS WARRANTY. EXCEPT AS SPECIFIED HEREIN, SHOULD THE SOFTWARE PROVE DEFECTIVE, YOU (AND NOT UNIVERSAL AUDIO OR A UNIVERSAL AUDIO-AUTHORIZED REPRESENTATIVE) ASSUME THE ENTIRE COST OF ALL NECESSARY SERVICING, REPAIR, OR CORRECTION. SOME STATES DO NOT ALLOW THE EXCLUSION OF IMPLIED WARRANTIES, SO THE ABOVE EXCLUSION MAY NOT APPLY TO YOU.

#### 6 Limitation of Liability.

UNIVERSAL AUDIO SHALL HAVE NO LIABILITY TO YOU OR ANY THIRD PARTY, WHETHER IN CONTRACT, TORT, NEGLIGENCE OR PRODUCTS LIABILITY, FOR ANY CLAIM, LOSS, OR DAMAGE, INCLUDING BUT NOT LIMITED TO LOST PROFITS, LOSS OF USE, BUSINESS INTERRUPTION, LOST DATA, OR LOST FILES, OR FOR ANY INDIRECT, SPECIAL, INCIDENTAL OR CONSEQUENTIAL DAMAGES OF ANY KIND OR NATURE WHATSOEVER ARISING OUT OF OR IN CONNECTION WITH THE USE OF OR INABILITY TO USE THE SOFTWARE OR DOCUMENTATION, OR THE PERFORMANCE OR OPERATION OF THE SOFTWARE, EVEN IF UNIVERSAL AUDIO HAS BEEN ADVISED OF THE POSSIBILITY OF SUCH DAMAGES. SOME STATES DO NOT ALLOW THE EXCLUSION OR LIMITATION OF INCIDENTAL OR CONSEQUENTIAL DAMAGES, SO THE ABOVE EXCLUSION OR LIMITATION MAY NOT APPLY TO YOU. IN NO EVENT SHALL UNIVERSAL AUDIO'S TOTAL LIABILITY TO YOU FOR ALL DAMAGES, LOSSES, AND CAUSES OF ACTION WHETHER IN CONTRACT, TORT (INCLUDING NEGLIGENCE) OR OTHERWISE EXCEED THE AMOUNT PAID BY YOU FOR THE SOFTWARE.

#### 7 Term.

This Agreement is effective until terminated. You may terminate the license without recompense at any time by returning the Software and all Documentation and any copies thereof (whether or not the copying was authorized hereunder) to Universal Audio and by removing the Software from the memory of any computer into which the Software has been transferred by you or with your permission. In addition to any other rights of Universal Audio, this license may be terminated by Universal Audio immediately and without notice in the event you fail to comply with any term or condition hereof. Upon termination by Universal Audio, you will return to Universal Audio, at your expense, the Software and all Documentation and any copies thereof (whether or not the copying was authorized hereunder).

#### 8 United States Government Rights.

The Software and Documentation are provided with RESTRICTED RIGHTS. Use, duplication, or disclosure by the Government is subject to restrictions as set forth in subparagraph (c)(1)(ii) of the Rights in Technical Data and Computer Software clause at DFARS 252.227-7013 or subparagraphs (c)(1) and (2) of the Commercial Computer Software-Restricted Rights at 48 CFR 52.227-19, as applicable. Manufacturer is Universal Audio, Inc., 1700 Green Hills Road, Scotts Valley, CA, 95066-4926 USA.

#### 9 Miscellaneous.

This Agreement shall be governed by and construed in accordance with the laws of the United States and the State of California, as applied to agreements entered into and to be performed entirely within California between California residents. If for any reason a court of competent jurisdiction finds any provision of this License or portion thereof to be unenforceable, that provision of the License shall be enforced to the maximum extent permissible so as to effect the intent of the parties, and the remainder of this License shall continue in full force and effect. This Agreement constitutes the entire agreement between the parties with respect to the use of the Software and Documentation, and supersedes all prior or contemporaneous understandings or agreements, written or oral, regarding such subject matter. No amendment to or modification of this License will be binding unless in writing and signed by a duly authorized representative of Universal Audio.

#### Contact.

Should you have any questions concerning this Agreement, please contact Universal Audio at 1700 Green Hills Road, Scotts Valley, CA, 95066-4926 USA, +1-831-440-1176 voice, +1-831-461-1550 fax, [www.uaudio.com](http://www.uaudio.com) web.

---

# TABLE OF CONTENTS

<b>Chapter 1. Introduction</b> .....	<b>13</b>
Welcome! .....	13
Features .....	15
The UAD System .....	16
Package Contents .....	16
Documentation Overview .....	16
Video Documentation - QuickStart DVD .....	18
Online Documentation .....	18
Customer Support .....	18
<b>Chapter 2. UAD Installation</b> .....	<b>20</b>
Overview .....	20
QuickStart DVD .....	20
System Requirements .....	21
Supported Hosts .....	21
Latest Information & Software Updates .....	22
UAD Software Installation .....	23
Install Software First .....	23
UAD Hardware Installation .....	25
Authorization .....	27
Authorize Plug-Ins Procedure .....	27
Load Authorization File .....	29
Offline Authorization .....	29
Using Unlicensed Plug-Ins .....	31
Verifying Installation .....	31
Learn More .....	32
Software Removal .....	32
<b>Chapter 3. UAD System Overview</b> .....	<b>33</b>
The UAD Environment .....	33
The UAD Hardware .....	33
The UAD Software .....	36
The DAW Environment .....	38
My.uaudio.com .....	40
Authorization .....	40
<b>Chapter 4. My.uaudio.com</b> .....	<b>41</b>
Optional Plug-Ins .....	41
Authorization Overview .....	42
Authorization Notes .....	44

---

# TABLE OF CONTENTS

Demo Mode . . . . .	45
UA Online Store . . . . .	46
Buying Plug-Ins . . . . .	48
Transferring UAD cards and licenses. . . . .	49
<b>Chapter 5. Using Multiple UAD Cards . . . . .</b>	<b>50</b>
Overview . . . . .	50
Mixed UAD System . . . . .	50
Plug-In License Policy . . . . .	50
Authorizing Multiple Cards . . . . .	51
Power Requirement . . . . .	51
Multicard DSP Loading . . . . .	52
Card Info Display . . . . .	52
Disabling Cards. . . . .	52
Host CPU . . . . .	53
<b>Chapter 6. UAD Meter &amp; Control Panel . . . . .</b>	<b>54</b>
Overview . . . . .	54
Launching the UAD Meter & Control Panel Application. . . . .	55
Using the UAD Meter . . . . .	55
UAD Meter Elements . . . . .	56
UAD Control Panel . . . . .	57
System Information Panel . . . . .	58
Plug-Ins Panel . . . . .	61
Configuration Panel . . . . .	64
Help & Support Panel . . . . .	70
<b>Chapter 7. Using UAD Powered Plug-Ins . . . . .</b>	<b>72</b>
Overview . . . . .	72
Launching a UAD Powered Plug-In . . . . .	72
The UAD Plug-In Window . . . . .	73
UAD Toolbar . . . . .	74
LiveTrack Mode . . . . .	76
Adjusting Parameters . . . . .	78
Shortcuts. . . . .	79
DSP Loading Information . . . . .	80
Automation . . . . .	81
External MIDI Control . . . . .	82

---

# TABLE OF CONTENTS

<b>Chapter 8. Tempo Sync</b> .....	<b>83</b>
Overview .....	83
Tempo Sync Plug-Ins .....	83
Available Note Values .....	84
Range Limits .....	85
Entering Values .....	85
Out of range .....	86
Modes with Tempo Sync .....	86
Roland RE-201 Sync .....	87
<b>Chapter 9. UAD Delay Compensation</b> .....	<b>88</b>
Latency & Delay Compensation .....	88
Host PDC Implementation .....	88
UAD Delay Compensator .....	90
DelayComp Examples .....	92
UAD Track Advance .....	93
TrackAdv Examples .....	94
Compensating Upsampled Plug-Ins .....	95
Upsampling Values Table .....	96
Upsampled Compensation Examples .....	97
Live Processing .....	99
<b>Chapter 10. UAD-Xpander &amp; UAD-Xtenda</b> .....	<b>100</b>
Overview .....	100
Xpander System Requirements .....	101
Xpander Installation .....	102
Xpander Connections .....	103
UAD-Xtenda .....	104
Xpander Operation .....	104
Important Xpander Notes .....	108
<b>Chapter 11. LA-2A and 1176LN</b> .....	<b>109</b>
Overview .....	109
Compressor Basics .....	109
Teletronix LA-2A Leveling Amplifier .....	112
LA-2A Controls .....	113
1176LN Solid-State Limiting Amplifier .....	114
1176LN Controls .....	115
1176SE “Special Edition” .....	117

---

# TABLE OF CONTENTS

<b>Chapter 12. LA-3A Compressor</b> .....	<b>118</b>
Overview .....	118
LA-3A Screenshot .....	118
LA-3A Controls .....	119
<b>Chapter 13. Fairchild 670.</b> .....	<b>120</b>
Overview .....	120
Fairchild Screenshot .....	121
2 Compressors, 4 Modes .....	121
Controls Overview .....	122
Fairchild Modes .....	123
Controls .....	124
<b>Chapter 14. Precision Multiband</b> .....	<b>128</b>
Overview .....	128
Precision Multiband Screenshot .....	128
Precision Multiband Interface .....	129
Band Controls .....	130
Band Parameters .....	131
EQ Display .....	135
Frequency Controls .....	137
Dynamics Meters .....	138
Global Controls .....	139
Precision Multiband Latency .....	141
<b>Chapter 15. Precision Limiter</b> .....	<b>142</b>
Overview .....	142
Precision Limiter Screenshot .....	143
Controls Overview .....	143
Precision Limiter Controls .....	143
Precision Limiter Meters Overview .....	144
Precision Limiter Latency .....	148
<b>Chapter 16. Precision Buss Compressor</b> .....	<b>149</b>
Overview .....	149
Precision Buss Compressor Screenshot .....	150
Precision Buss Compressor Controls .....	150
Extra Presets .....	154
WebZine Article .....	154

---

# TABLE OF CONTENTS

<b>Chapter 17. Neve 33609 Compressor</b> .....	<b>155</b>
Overview .....	155
Neve 33609 Screenshot .....	156
Operation .....	156
Neve 33609 Controls .....	157
Limiter .....	157
Compressor .....	158
Other Controls .....	159
Neve 33609SE .....	164
Neve 33609 Latency .....	164
<b>Chapter 18. VCA VU</b> .....	<b>165</b>
Overview .....	165
VCA VU Screenshot .....	165
VCA VU Controls .....	166
WebZine Articles .....	167
<b>Chapter 19. Neve 88RS Channel Strip</b> .....	<b>168</b>
Overview .....	168
Neve 88RS Screenshot .....	169
Neve 88RS Controls .....	170
Dynamics .....	170
Gate/Expander .....	171
Limiter/Compressor .....	174
Equalizer .....	177
Cut Filters .....	180
Global .....	181
WebZine Article .....	182
<b>Chapter 20. CS-1 Channel Strip</b> .....	<b>183</b>
Overview .....	183
EX-1 Equalizer and Compressor .....	184
EX-1 Equalizer Controls .....	184
EX-1 Compressor Controls .....	185
EX-1M Overview .....	186
DM-1 Delay Modulator .....	187
DM-1 Controls .....	187
DM-1L .....	189
RS-1 Reflection Engine .....	190
RS-1 Controls .....	191



---

# TABLE OF CONTENTS

<b>Chapter 21. Precision Equalizer</b> .....	<b>193</b>
Overview .....	193
Precision Equalizer Screenshot .....	193
Precision Equalizer Controls .....	194
Control Grouping .....	194
Modes .....	194
Band Controls .....	196
Precision Equalizer Latency .....	198
<b>Chapter 22. Cambridge EQ.</b> .....	<b>199</b>
Overview .....	199
Cambridge EQ Screenshot .....	199
Cambridge EQ Controls .....	200
Low Cut / High Cut Filters .....	203
EQ Bands .....	204
Parametric EQ .....	205
Shelf EQ .....	208
<b>Chapter 23. Pultec and Pultec-Pro</b> .....	<b>210</b>
Overview .....	210
Pultec Latency .....	211
Pultec EQP-1A Screenshot .....	211
Pultec EQP-1A Controls .....	211
Low Frequency Controls .....	212
High Frequency Controls .....	213
High Attenuation Controls .....	213
Pultec MEQ-5 Screenshot .....	214
Pultec MEQ-5 Controls .....	214
Low Peak Controls .....	215
Dip Controls .....	215
High Peak Controls .....	215
MEQ-5 Response Curves .....	215
<b>Chapter 24. Neve 1073 Equalizer.</b> .....	<b>219</b>
Overview .....	219
Neve 1073 Screenshot .....	219
Neve 1073 and 1073SE Controls .....	220
Neve 1073SE .....	222
Neve 1073 Latency .....	223

---

# TABLE OF CONTENTS

<b>Chapter 25. Neve 1081 Equalizer</b> .....	<b>224</b>
Overview .....	224
Neve 1081 Screenshot .....	224
Neve 1081 and 1081SE Controls .....	225
Neve 1081SE .....	230
Neve 1081 Latency .....	230
<b>Chapter 26. Helios Type 69 Equalizer</b> .....	<b>231</b>
Overview .....	231
Helios Type 69 Screenshot .....	231
Helios Type 69 Controls .....	232
Helios 69 Latency .....	235
WebZine Article .....	235
<b>Chapter 27. Roland CE-1</b> .....	<b>237</b>
Overview .....	237
Roland CE-1 Screenshot .....	237
Roland CE-1 Controls .....	238
<b>Chapter 28. Roland Dimension D</b> .....	<b>241</b>
Overview .....	241
Roland Dimension D Screenshot .....	241
Roland Dimension D Controls .....	242
<b>Chapter 29. Roland RE-201</b> .....	<b>243</b>
Overview .....	243
Roland RE-201 Screenshot .....	244
Roland RE-201 Interface .....	244
Roland RE-201 Controls .....	244
<b>Chapter 30. RealVerb Pro</b> .....	<b>250</b>
Overview .....	250
RealVerb Pro Background .....	251
Spectral Characteristics .....	252
Resonance (Equalization) .....	257
Timing .....	258
Positioning .....	260
Levels .....	262
Morphing .....	262
RealVerb Pro Preset Management .....	264
RealVerb Pro Preset List .....	264

---

# TABLE OF CONTENTS

<b>Chapter 31. DreamVerb</b> .....	<b>265</b>
Overview .....	265
Signal Flow .....	266
Resonance (Equalization) Panel .....	267
Shape Panel .....	269
Materials Panel .....	271
Reflections Panel .....	273
Reverberation Panel .....	275
Positioning Panel .....	276
Levels Panel .....	278
DreamVerb Preset Management .....	279
Spatial Characteristics .....	280
Preset Design Tips .....	281
<b>Chapter 32. Plate 140</b> .....	<b>283</b>
Overview .....	283
Plate 140 Screenshot .....	283
Plate 140 Controls .....	284
Reverb .....	284
EQ .....	285
Hidden Controls .....	288
<b>Chapter 33. Precision Maximizer</b> .....	<b>290</b>
Overview .....	290
Precision Maximizer Screenshot .....	291
Precision Maximizer Controls .....	291
Operating Tips .....	295
Precision Maximizer Latency .....	296
WebZine Article .....	296
<b>Chapter 34. Precision De-Esser</b> .....	<b>297</b>
Overview .....	297
Precision De-Esser Screenshot .....	297
Precision De-Esser Controls .....	298
Operating Tips .....	300
<b>Chapter 35. Precision Enhancer kHz</b> .....	<b>301</b>
Overview .....	301
Precision Enhancer kHz Screenshot .....	302
Precision Enhancer kHz Controls .....	302

---

# TABLE OF CONTENTS

<b>Chapter 36. SPL Transient Designer</b> .....	<b>305</b>
Overview .....	305
SPL Transient Designer Screenshot .....	305
SPL Transient Designer Controls .....	306
WebZine Article .....	307
Acknowledgement .....	308
Applications .....	308
Technology .....	312
<b>Chapter 37. Nigel</b> .....	<b>316</b>
Introducing Nigel .....	316
Preflex Plug-in .....	318
Preflex Modules .....	318
Gate/Comp Module .....	319
Amp Module .....	322
Amp Controls .....	323
Cabinet Module .....	326
Phasor Module .....	328
Mod Filter Module .....	331
TremModEcho plug-in .....	335
Trem/Fade Module .....	336
Mod Delay Module .....	339
Echo Module .....	343
<b>Chapter 38. History</b> .....	<b>345</b>
Bill Putnam Sr. ....	345
Classic Compressors .....	349
Pros Talk UA .....	352
Thank You .....	356

## CHAPTER 1

# Introduction

### Welcome!

Congratulations, and welcome to the UA Family! You now own the best sounding, most powerful sonic upgrade available for your DAW. The UAD-2 and version 5.0 software represents the culmination of a multi-year development effort delivering the latest in state-of-the-art audio processing technology and is the next evolution of the revolutionary, award-winning UAD-1 Powered Plug-Ins & DSP Card Platform

For many years our customers have been asking for a UAD with more power and the UAD-2 is all about putting more power in your hands – more power to track, mix and master. The UAD-2 Quad offers, on average, an incredible 10 times the power of the UAD-1, while the UAD-2 Duo offers 5 times, and UAD-2 Solo offers 2.5 times the power. The UAD-2 Quad supports an awe-inspiring 128-channel Neve 88RS mixer at 44.1k. That’s a full console for the largest of professional mixes on ONE incredibly priced UAD-2 card!

The UAD-2 of course, seamlessly works alongside up to 4 UAD-1’s or UAD-1e’s but also allows any 4 UAD-2 cards to be mixed and matched to conveniently scale the DSP power you want at the price you can afford. Start with a Nevana 32 and instantly run a 32 channel Neve 88RS console. Then, simply add more cards for additional outboard FX or more mix channels as your needs grow. Pro power-users can now use up to four UAD-2 Quads for the most demanding applications with equivalent potency to 40 UAD-1 cards! Now inside-the-box mixing is as powerful as outside.

Once you’re settled in with your new UAD-2 select from our ever growing Powered Plug-Ins Collection to custom build your own virtual mixing console, mastering console, mix sidecar, or inboard dream-FX-rack from UA’s exclusive collection of revered studio gear including classics from Neve®, Roland/BOSS®, Helios®, Fairchild, Pultec, SPL®, Moog® and of course UA’s own 1176LN, LA-2A, and LA-3A compressors, as well as our critically acclaimed line of Precision Mix Series and Mastering Series plug-ins. Digital recreations of other seminal analog studio gems from legendary analog manufactures are on the way including the Empirical Labs® Fatso, a channel strip from the famed Harrison® 4032c “Thriller” console, the Little Labs® IBP, and select Valley People® EQ’s, Compressors, and Gates.

The UAD-2 also introduces version 5.0 of the UAD software, which includes major driver enhancements and an all-new unified UAD Meter & Control Panel for UAD-1 and UAD-2. Version 5.0 features multicore-aware drivers, LiveTrack™ for low-latency tracking and monitoring through UAD-2 plug-ins, and L.O.D.E.™ [Live Optimizing DSP Engine], which dynamically balances the load on the UAD-2. The new UAD Meter & Control Panel offers improved status monitoring, easy Quick-Click Plug Purchasing, Help and Support resources, Software Updates, and improved rollover help. There's also a new streamlined web shopping experience via a completely re-designed UA website with integrated audio and video demo's, tutorials, in-depth webzine articles, FAQ's and enhanced support so you can really get the most out of your UAD-2.

Developing the UAD-2 as well as Universal Audio's entire line of quality audio products designed to meet the needs of the modern recording studio while retaining the character of classic vintage equipment—has been a very special experience for me and for all who have been involved. We hope that you will enjoy using your UAD-2 and Powered Plug-Ins as much as we do.

Thanks for your support of Universal Audio.

Sincerely,  
Bill Putnam, Jr.  
CEO, Owner

A handwritten signature in black ink, appearing to read 'Bill Putnam, Jr.', with a long horizontal line extending to the right.

## Features

- High-bandwidth x1 PCI Express card (PCIe 2.0 compatible)
- UAD-2 Solo: low-profile, half-height, short PCIe card
- UAD-2 Duo/Quad: full-height, short PCIe card
- 1, 2 or 4 Analog Devices SHARC 21369 floating-point processors\*
- Averages 2.5X(Solo), 5X(Duo), 10X(Quad) the power of UAD-1
- Multi-card support for up to 4 UAD-2's and 4 UAD-1's in one computer
- Cross-Platform for Mac OS X 10.4/10.5, Windows XP/x64, Vista32/64
- Supports VST, RTAS, and Audio Units plug-in formats
- 44.1, 48, 88.2, 96, 176.4, 192kHz sample rate support for all plug-ins\*
- Drivers optimized for modern multi-thread and multi-processor architectures
- Real-time and faster than real-time processing for mix bounces
- LiveTrack™ low-latency mode for monitoring, tracking and performance\*
- SessionMap™ bi-directional UAD-1 <> UAD-2 session compatibility
- L.O.D.E.™ (Live Optimizing DSP Engine) automatically balances DSP loads\*
- LoadLock™ ensures resource availability on loaded plug-ins\*
- Redesigned plug-in Toolbar includes improved preset management
- Redesigned UAD Meter & Control Panel application
- Simplified Registration/Authorization process via one button click
- Features UAi™, UA's unique analog modeling technology
- World's best plug-in library with premier titles from Neve®, Roland®, Moog®, SPL®, Pultec, and more
- 14-day full function demo for all plug-ins; try before you buy
- Powered Plug-Ins™ available 24/7 @ my.uaudio.com
- Easy license transfer for existing UAD-1/1e/Xpander users
- Generous launch crossgrade promotions for all existing UAD-1 users
- UAD v5.0 supports all existing UAD hardware
- All UAD hardware and software designed and manufactured in U.S.A.

\*UAD-2 Only

## The UAD System

The UAD Powered Plug-Ins package is a hardware-plus-software system that consists of one or more UAD DSP cards combined with the Powered Plug-Ins software. Multiple UAD package types are available in the product line to accommodate your particular hardware system, processing needs, and budget.

The difference between each package are the UAD card type and the selection of plug-ins that are bundled with the card. Each bundle has either a set of included plug-ins, or a voucher system that you use to specify the particular plug-ins you want at our online store.

For a detailed overview about the UAD Powered Plug-Ins system and how it operates, see [Chapter 3, “UAD System Overview.”](#)

## Package Contents

Each UAD retail package includes:

- UAD DSP hardware card
- UAD Software Installer CD-ROM (with PDF user documentation)
- UAD QuickStart DVD (video tutorials)
- UA Product Catalog DVD (video demonstrations)
- UAD plug-in voucher (if applicable; redeemable at UA online store)
- UAD-Xpander has additional contents (see [Chapter 10, “UAD-Xpander & UAD-Xtenda”](#))

## Documentation Overview

This section describes the various instructional and technical resources that are available for installing, using, and troubleshooting UAD Powered Plug-Ins. Documentation for the product line is available in written, video, and on-line formats.

## ReadMe

The ReadMe contains important, late-breaking information that is not available in other locations. Please review all the information in the ReadMe before installing or using UAD Powered Plug-Ins. The ReadMe file is presented for viewing during the software installation process.



<b>User Manual</b>	<p>This complete user manual for the product (the document you are reading now) is included in the software bundle. The filename of the manual is UAD-Manual.pdf.</p> <p>The User Manual is the primary product user documentation. It is on the software CD-ROM, and is also placed inside the Powered Plug-Ins Tools folder on the hard drive during software installation.</p> <p><b>Installed Locations</b></p> <p>The ReadMe and Manual files are copied to the hard drive by the software installer to the following locations:</p> <ul style="list-style-type: none"> <li>• Start Menu&gt;All Programs&gt;UAD Powered Plug-Ins</li> <li>• Startup Disk/Applications/Powered Plug-Ins Tools</li> </ul>
<b>Windows</b>	
<b>Macintosh</b>	
<b>Manual Conventions</b>	<p>UAD Powered Plug-Ins is a cross-platform solution for both Windows and Macintosh computers. The UAD hardware card can be installed into either platform; it is the exact same hardware for both platforms. Operation of the plug-ins is practically identical regardless of the host system platform and application. However, certain platform-specific instructions will differ according to the host system you are using.</p>
<b>Platforms</b>	<p>Instructions in this guide that are platform-specific are indicated with a heading in red letters. Instructions that are identical regardless of platform are not differentiated.</p>
<b>Windows</b>	Instructions specific to the Windows platform use this red Windows heading.
<b>Macintosh</b>	Instructions specific to the Mac platform use this red Macintosh heading.
<b>UAD Nomenclature</b>	<p>Unless specified otherwise, for descriptive purposes within this manual, “UAD-2” means all UAD-2 family products (Solo, Duo, Quad); “UAD-1” means all UAD-1 family products (UAD-1, UAD-1e, and UAD-Xpander); and “UAD” means all UAD-2 and UAD-1 family products.</p>
<b>Screen Shots</b>	<p>Screenshots in this manual may be taken from the Windows and/or Macintosh version of the software, and are used interchangeably when the content and functionality of the screenshot is the same on both platforms. Slight variations in the appearance of a screenshot between operating systems are inevitable.</p>

When the content of and function of the software represented in a screenshot is identical on both platforms, no differentiation is made in the screenshot title. If there is a significant difference between platforms, screenshots from both platforms are included.

## Video Documentation - QuickStart DVD



The QuickStart DVD provided in the retail package contains numerous helpful video movies that explain how to install the hardware and software, register and authorize your product, obtain optional plug-ins, and more. The QuickStart DVD can be viewed in a standard DVD player or computer. Many of the videos are online on our support website.

## Online Documentation

The technical support pages on our website offer a wealth of helpful information that is not included in the documentation contained within the software bundle. Please visit our support pages for important technical information including the latest release notes, host application notes, and more. The main UAD Powered Plug-Ins support website is:

**Support Website** • <http://uaudio.com/support/UAD>

**Webzine** Our online magazine is published regularly and contains lots of useful and interesting information. How-to pages, artist/producer/engineer interviews, support Q & A, detailed scientific notes, and other fascinating articles make the Webzine a great place to routinely visit:

• <http://www.uaudio.com/webzine>

**Users Forum** The unofficial UAD Powered Plug-Ins users forum, for the exchange of tips and information, is on the world wide web at:

• <http://www.chrismilne.com/uadforums>

## Customer Support

Customer support is provided by Universal Audio staff to all registered UAD Powered Plug-Ins users. See [“Registration” on page 47](#) for details.

**Support Hours** Our support specialists are available to assist you via email and telephone during our normal business hours, which are from 9am to 5pm, Monday through Friday, Pacific Standard Time.

**Email Support**

- Windows: pcsupport@uaudio.com
- Macintosh: macsupport@uaudio.com
- Online purchases & store support: onlinesupport@uaudio.com

**Phone Support** Customer Service & Technical Support  
USA toll-free: 877-MY-UAUDIO (1-877-698-2834)  
International: +1-831-440-1176

**Fax Number** +1-831-461-1550

**Factory Address** Universal Audio, Inc.  
1700 Green Hills Road  
Scotts Valley, CA 95066-4926  
USA

- <http://www.uaudio.com>

**Feedback** Your feedback on the performance and features of UAD Powered Plug-Ins is very important to us. Please send your comments and suggestions to us. Comments (not technical support issues) may be sent to [info@uaudio.com](mailto:info@uaudio.com).



Awards for UAD-1 and/or UAD-1 Plug-Ins

## CHAPTER 2

# UAD Installation

### Overview

UAD Powered Plug-Ins installation and configuration consists of four steps:

- UAD software installation  
*Insert the enclosed CD-ROM and run the installer.*
- UAD hardware installation  
*UAD-1 requires PCI slot, UAD-1e/UAD-2 works in all size PCIe slots.*
- UAD card registration  
*Add your card to your [my.uaudio.com](http://my.uaudio.com) [Account](#).*
- UAD plug-in authorization  
*Download and apply UAD authorization file. UAD vouchers can be redeemed and optional plug-in licenses can be purchased anytime.*

These steps are detailed in this chapter. Your host computer must meet the hardware and software requirements to operate properly, and you need a supported VST, RTAS, or Audio Units host application to run the UAD Powered Plug-Ins.

### QuickStart DVD

The QuickStart DVD provided in the retail package contains helpful videos guide you through the software and hardware installation process. The videos are also on our website:

- <http://uaudio.com/support/UAD>



## System Requirements

**UAD Powered Plug-Ins require the following hardware and software:**

### Windows:

- Microsoft Windows XP (Home, Professional, or x64 Edition), or Windows Vista (x86 or x64)

### Macintosh

- Mac OS X 10.4.x "Tiger" or 10.5.x "Leopard"  
(Processor upgrade cards are not officially supported)

### All Platforms:

- Available PCIe x1/x4/x8/x16 slot for each UAD-2 and UAD-1e card
- Available PCI or PCI-X slot for each UAD-1 card
- ExpressCard/34 or ExpressCard/54 expansion slot for each UAD-Xpander
- Available PCIe (PCI Express) slot for each optional UAD-Xtenda card
- 256 MB RAM (512 MB is strongly recommended)
- 125 MB available hard drive space for UAD-2 or UAD-1 install
- 250 MB available HD space for combined UAD-2 plus UAD-1 install
- 1024 x 768 or higher resolution monitor
- CD-ROM drive or internet connection for software installation
- Internet connection required for registration and plug-in authorization
- Compatible VST, RTAS, or Audio Units plug-in host application software (see [Table 1 on page 22](#))
- AGP or PCIe graphics video adapter card (PCI graphics not supported)

## Supported Hosts

UAD Powered Plug-Ins, when combined with a plug-in host application, is a technically complex system with many variables. Because the host application environment is integral to the system but is completely out of our control, we cannot claim compatibility with all hosts that may claim to support the use of VST, RTAS, and/or Audio Units plug-ins.

We test the specific host applications listed in [Table 1 on page 22](#) for compatibility with UAD Powered Plug-Ins, and only these hosts are supported by our technical staff. We recommend the latest versions of these host applications for optimum performance. Host applications that are not listed may work with UAD Powered Plug-ins, but compatibility with them cannot be guaranteed.

For detailed technical information about using UAD Powered Plug-Ins with these supported hosts, please review the Host Application Notes pages on the UAD support website.

Table 1. Supported Host Applications

<b>Windows VST</b>	<b>Macintosh VST</b>	<b>Win &amp; Mac RTAS</b>
Steinberg Cubase SX	Steinberg Cubase SX	Digidesign Pro Tools
Steinberg Nuendo	Steinberg Nuendo	
Steinberg Wavelab 6	BIAS Peak	
Ableton Live	Ableton Live	
Cakewalk Sonar	DSP Quatro Pro	
Mackie Tracktion	Mackie Tracktion	
Magix Samplitude		
Magix Sequoia	<b>Macintosh Audio Units</b>	
Image-Line FL Studio	MOTU Digital Performer (4.5+)	
Adobe Audition	Apple Logic 7, 8	
Sony Vegas	Apple Final Cut Pro	
Sony Acid Pro	Apple Soundtrack	
Sony Sound Forge	Apple Garage Band	
	Audiofile Wave Editor 1.3	

## Latest Information & Software Updates

### Technical Updates

Updated UAD technical information is regularly posted to the UA website. Please visit the UAD support pages for the latest bulletins:

- <http://www.uaudio.com/support/UAD>

### Software Updates

The CD-ROM in the retail package may not contain the latest UAD software. Check our website for software updates:

- <http://www.uaudio.com/downloads.html>

If the UAD software is already installed, the UAD Meter & Control Panel has a convenient button that links to the updates page ("[Check for Updates](#)" on [page 58](#)).

# UAD Software Installation

## Install Software First

If you are installing UAD Powered Plug-Ins for the first time, install the software before installing the UAD card(s). This is particularly important on Windows systems. If you are updating the software or installing additional UAD cards, it is not necessary to remove the previous UAD software or hardware from the system, but you should still install the newer software before adding new cards.

**Note:** *The UAD Powered Plug-Ins software installer is identical for all UAD hardware (there are only two UAD installers, one each for Win & Mac).*

### Win & Mac

Software installation and removal for Windows and Macintosh platforms have their own particular procedures; each are described below.

**Important:** *Close all open files and applications before starting the installation procedure. Specifically, make sure the UAD Meter & Control Panel and all host applications using UAD Powered Plug-Ins are not running.*

### Windows Install



#### Software Installation Procedure for Windows Systems

**Important:** *Verify the computer system date and time are set correctly before installing the software and/or launching the UAD Meter & Control Panel application for the first time.*

1. Launch the software installer.
  - To install from CD-ROM, insert the UAD Powered Plug-Ins CD. If the installer doesn't automatically run, double click the Setup.exe application located on the CD
  - To install from a download, double-click the downloaded software archive, which is an executable application. The installer will run automatically.
2. Setup will guide you through the installation procedure.
3. When installation has completed, power down your system to install the UAD card(s) following the instructions on [page 25](#). If the UAD card is already installed or you are updating, restart the system.
4. After restarting, the New Hardware Wizard will try to locate the new drivers. Follow these steps:

- a) Select the “Install the software automatically (Recommended)” option, and click “Next.”
- b) The UAD card driver will be installed, click “Finish” when it is complete.
- c) (UAD-1 only) The New Hardware Wizard will run again to look for the second UAD-1 driver. Select the “Install the software automatically (Recommended)” option, and click “Next.” The second UAD-1 driver will be installed; click “Finish” when it’s complete.

**Software installation is now complete. Proceed to the Authorization section (page 27).**

You can use the UAD Meter & Control Panel to verify installation (see “Verifying Installation” on page 31.)

**Note:** *If you want to install the UAD plug-ins into another application, run the installer again.*

## Macintosh Install



### Software Installation Procedure for Macintosh Systems

**Important:** *Verify the computer system date and time are set correctly before installing the software and/or launching the UAD Meter & Control Panel application for the first time.*

1. Launch the software installer.
  - To install from CD-ROM, insert the UAD Powered Plug-Ins CD. Open the CD window, then double-click the application named “UAD Powered Plug-Ins Installer.”
  - To install from a download, first decompress the downloaded .zip archive by double-clicking it. Then double-click the resulting .dmg file to mount the disk image. Double-click the disk image to open its window, then double-click the application named “UAD Powered Plug-Ins Installer.”
2. The installer will guide you through the installation procedure.
3. Restart the computer after the software is installed.

**Software installation is now complete. Proceed to hardware installation or if that is done already, proceed to the Authorization section (page 27).**

You can use the UAD Meter & Control Panel to verify installation (see “Verifying Installation” on page 31.)

## Installed Locations

The ReadMe, UADManual.pdf, and UAD Meter & Control Panel application are copied to these locations on the hard drive during installation:



## Windows



- C:\Program Files\Universal Audio\Powered Plugins

You can access these files from the Windows Start Menu at:

- Start>All Programs>UAD Powered Plug-Ins

The VST plug-in files are installed to the location specified during installation.

## Macintosh



- Startup Disk/Applications/Powered Plug-Ins Tools

The plug-in files are installed to the standardized OS X locations:

- VST: Startup Disk/Library/Audio/Plug-Ins/VST/Powered Plug-Ins
- Audio Units: Startup Disk/Library/Audio/Plug-Ins/Components
- RTAS: Startup Disk/Library/Application Support/Digidesign/Plug-Ins

## UAD Hardware Installation

The UAD software should be installed before installing the UAD DSP card(s). See the previous section for software installation instructions.

### UAD-Xpander

The UAD-Xpander has its own set of hardware connection and operation instructions. Refer to [Chapter 10, “UAD-Xpander & UAD-Xtenda”](#) for details.

### About PCI and PCI Express

PCI and PCI-X should not be confused with PCI Express (also known as PCIe). PCIe is not compatible with PCI or PCI-X because PCIe uses a completely different connector (see [Figure 1 on page 26](#)).

However, if a computer system has both PCI/PCI-X and PCIe slots, the UAD-1, UAD-1e, and UAD-2 can all be installed and used simultaneously as a multocard system. See [Chapter 5, “Using Multiple UAD Cards.”](#)

**Important:** *The UAD-1 will ONLY work in PCI and PCI-X slots, and the UAD-1e, UAD-2, and UAD-Xtenda will ONLY work in PCI Express (PCIe) slots. Be extremely careful to only install the UAD card(s) into a compatible slot!*

**PCI/PCI-X:  
UAD-1 only**

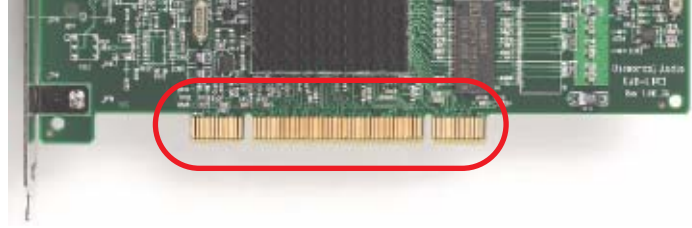

**PCI Express (PCIe):  
UAD-1e  
UAD-2  
UAD-Xtenda**

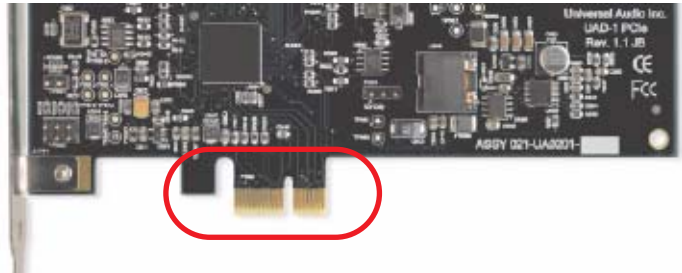

Figure 1. PCI and PCIe connectors are incompatible

### PCIe x1

UAD-2, UAD-1e, and UAD-Xtenda are “x1” PCIe cards. Although these cards can be installed in any x1/x4/x8/x16 PCIe slot, putting a them in any PCIe slot faster than x1 will not improve performance.

### Installing the UAD Cards

After installing the UAD Powered Plug-Ins software, install the UAD DSP card(s). Hardware installation is the same for all platforms.

#### To install the UAD DSP and/or UAD-Xtenda card(s):

1. Install the UAD software first ([page 23](#)).
2. Power down the computer system.
3. Open the computer case. If necessary, refer to the computer manufacturer’s documentation for instructions.
4. Remove the rear slot cover and screw of an available expansion slot.
5. Before handling the UAD card, discharge any static electricity by touching the outer casing of the power supply.
6. Remove the UAD card from its protective anti-static bag. Do not touch the gold edge connector contacts.

7. Hold the card gently by the top edges, and line up its connector with the slot inside the computer.

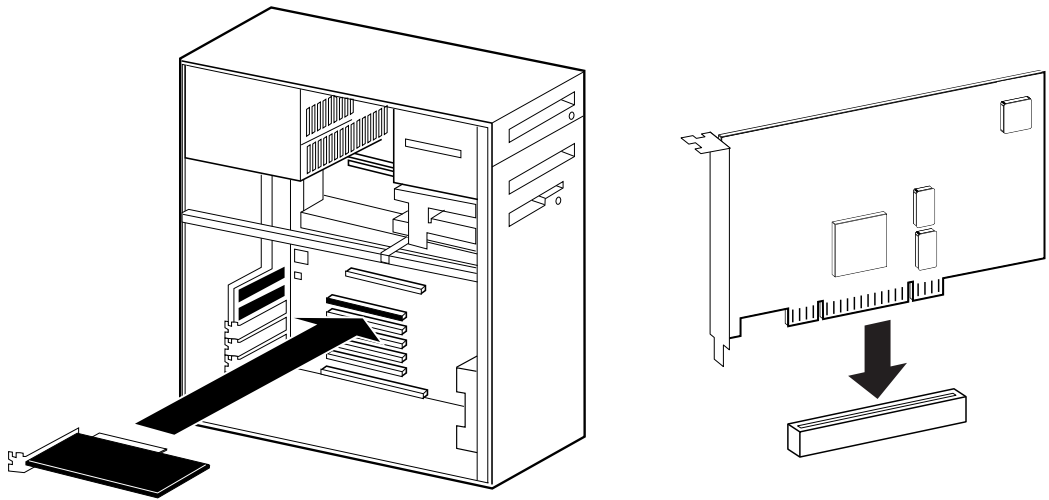

Figure 2. UAD-1 card installation in PCI slot. UAD-2 in PCIe is similar.

8. When the connector and slot are aligned, press the card into the slot with firm, even pressure. The card should “pop” into place. The top of the slot on the motherboard should be flush and parallel with the edge of the UAD card.
9. Secure the card with the previously removed screw.
10. Replace the computer case

**Hardware installation is now complete. Proceed to Authorization in the next section.**

## Authorization

Your UAD card must be registered at [my.uaudio.com](http://my.uaudio.com) to download an authorization file, and you need a [my.uaudio.com](http://my.uaudio.com) account to register the card. As of UAD v5.0, these procedures are significantly simplified, and are detailed in the “[Authorize Plug-Ins Procedure](#)” on page 27.

**Important:** All UAD plug-ins must be authorized before they can be used. Authorization is accomplished by clicking the “[Authorize Plug-Ins...](#)” button in the UAD Meter & Control Panel. The procedure is in the next section.

## Authorize Plug-Ins Procedure

This procedure provides only the step-by-step process for UAD authorization. A complete overview of UAD authorization, [my.uaudio.com](http://my.uaudio.com), and the UA on-line store is in [Chapter 4, “My.uaudio.com.”](#)

**Note:** The following procedure requires an internet connection on the UAD host computer. To authorize from a system that is not online, see [Offline Authorization](#).

## Online Authorization

**To download and apply the UAD authorization file when connected to the internet:**

1. Install UAD v5.0 (or higher) software and the UAD hardware using the procedures detailed in this chapter (the system must be operating properly).
2. Launch the UAD Meter & Control Panel application (see [page 55](#)) and open the Plug-Ins panel (see [page 57](#)).
3. Click the “Authorize Plug-ins...” button ([page 61](#)). The my.uaudio.com online store opens in the default web browser.
  - If you don’t already have a my.uaudio.com account, you are directed to create one. Follow the instructions online.
  - If you already have a my.uaudio.com account, login with your email address and password. If your password is lost, the store can email it to you.
4. Your card will be automatically registered and added to your “My Systems” Computer group, and your authorization file is generated.
5. The authorization file should begin downloading automatically. Click the “Download Authorization” link to download the auth file if not. The authorization file is downloaded by the browser to the location specified in the browser preferences.
6. “Drag and drop” the authorization file onto any UAD Meter & Control Panel application icon/shortcut/alias. Drag and drop means click then hold the downloaded authorization file with the mouse, drag it on top of any UAD Meter & Control Panel application icon until the icon is highlighted, then release the mouse (see [Figure 3 on page 29](#)).
7. The authorization is loaded onto the UAD card(s) and after a few seconds the “Authorizations Updated Successfully” window appears ([Figure 3](#)).

**Online UAD authorization is now complete, and UAD Powered Plug-Ins are ready for use.**

## Load Authorization File

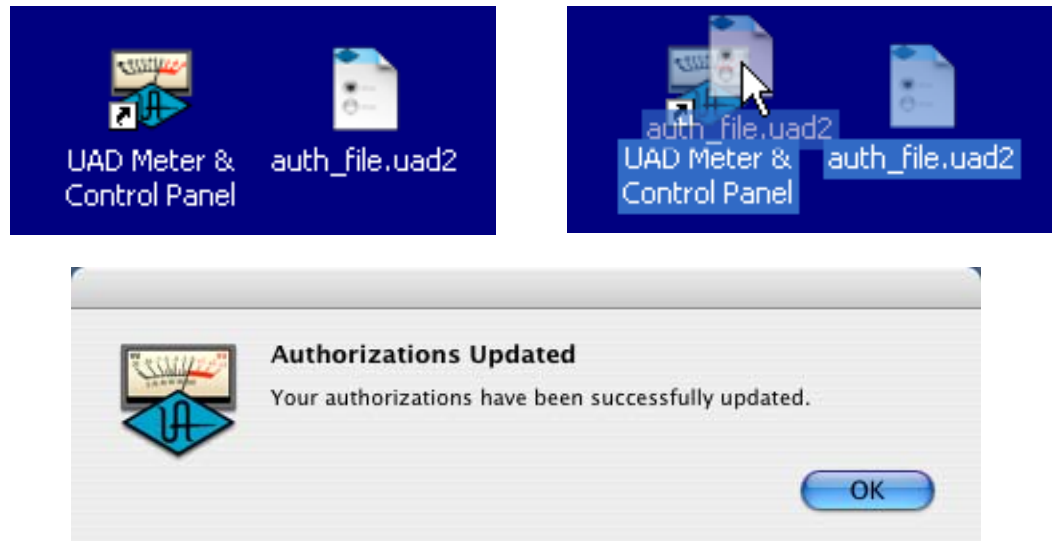

Figure 3. Drag-and-drop to load the UAD authorization file.

## Offline Authorization

If the UAD computer is not connected to the internet, you will need to manually transfer the registration URL into the browser of a web-enabled computer.

**To download and apply the UAD authorization file if not connected to the internet:**

1. Install UAD v5.0 (or higher) software and the UAD hardware using the procedures detailed in this chapter (the system must be operating properly).
2. Launch the UAD Meter & Control Panel application (see page 55) and open the Plug-Ins panel (see page 57).
3. Click the "Authorize Plug-ins..." button (page 61). The default web browser opens with the registration URL in the address bar (and you may get an error that the computer is not connected to the internet).
4. You must enter this URL into a web-connected computer, so either:
  - a) Drag the URL icon to the Desktop to create a weblink shortcut then transfer the weblink shortcut to the internet computer (preferred, Figure 4), OR
  - b) Carefully write down the URL, EXACTLY as it appears.
5. Go to the URL using a web browser on an internet-connected computer. Double-click the transferred weblink shortcut, or enter the URL as noted.
  - If you don't already have a my.uaudio.com account, you are directed to create one. Follow the instructions online.

- If you already have a my.uaudio.com account, login with your email address and password. If your password is lost, the store can email it to you.
6. Your card will be automatically registered and added to your “My Systems” Computer group, and your authorization file is generated.
  7. The authorization file should begin downloading automatically. Click the “Download Authorization” link to download the auth file if not.
  8. Transfer the authorization file to the UAD computer.
  9. “Drag and drop” the authorization file onto any UAD Meter & Control Panel application icon/shortcut/alias. Drag and drop means click then hold the downloaded authorization file with the mouse, drag it on top of any UAD Meter & Control Panel application icon until the icon is highlighted, then release the mouse (see [Figure 3 on page 29](#)).
  10. The authorization is loaded onto the UAD card(s) and after a few seconds the “Authorizations Updated Successfully” window appears ([Figure 3](#)).

**Online UAD authorization is now complete, and UAD Powered Plug-Ins are ready for use.**

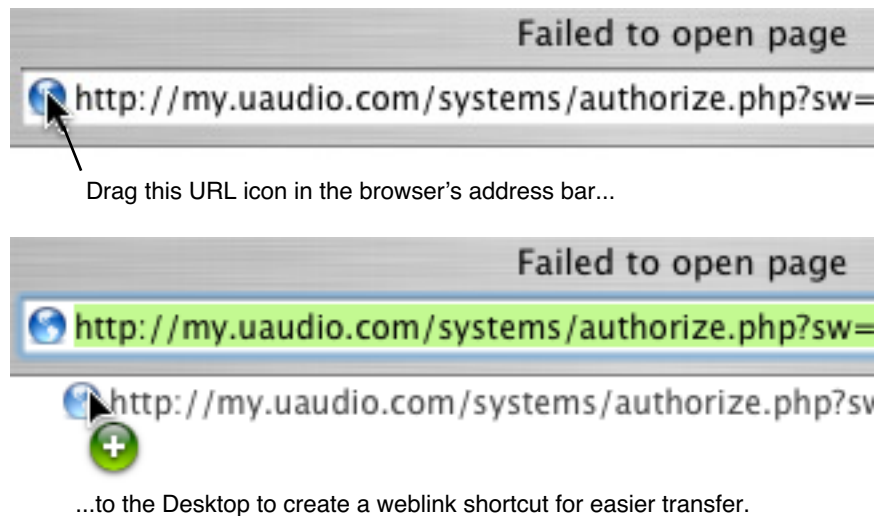

Figure 4. Creating the URL shortcut

## Using Unlicensed Plug-Ins

To run unlicensed UAD plug-ins after authorization, see “[Demo Mode](#)” on [page 45](#). To redeem vouchers or coupons, or purchase additional UAD plug-in licenses, see “[UA Online Store](#)” on [page 46](#).

## Verifying Installation

The [UAD Meter & Control Panel](#) displays the current resource loads of the UAD DSP hardware card in realtime. It also contains the System Information panel, where UAD software and hardware installation can be verified to ensure the system is working properly.

**To confirm proper UAD installation and operation:**

1. Launch the UAD Meter & Control Panel application ([see page 55](#)).
2. Open the System Information panel ([see page 57](#)).
3. When the UAD card is displayed in the Hardware area and its status is “OK” then the UAD driver is communicating with the UAD card and the system is operating properly. Done!

## UAD-2 LED

The UAD-2 has an LED on its mounting bracket. The UAD-2 LED provides certain indications about the operational state of the UAD-2.

### Flashing red and green

The card is powered up properly but the UAD driver is not yet loaded or communicating with the card. This is the expected state if the card is installed but the software is not yet installed, or when booting the system and the UAD driver is not yet loaded.

### Solid green

The UAD driver is loaded and properly communicating with the card. This is the normal state when using UAD Powered Plug-Ins.

### Solid red

There is a problem with communication between the driver and the card. Try a cold reboot (complete power down) and/or reinstalling the UAD software.

## Learn More

After installation, registration, and authorization, you're ready to use UAD Powered Plug-Ins. The videos in the UAD Quickstart and Product Catalog DVD's in the retail package are there to help you learn more about using the product, and available optional plug-ins.

Just pop into any standard DVD player or computer and browse the available video selections.

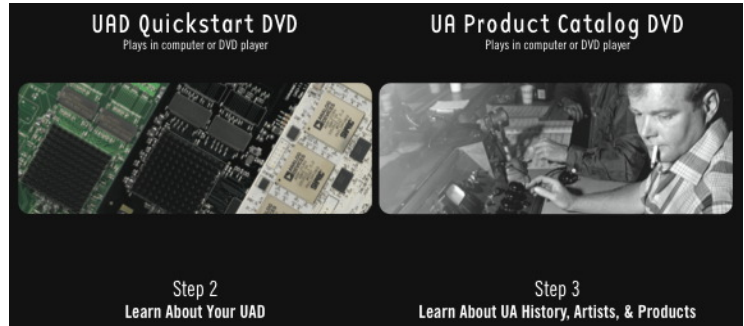

## Software Removal

**To remove all UAD software from the computer:**

### Windows



1. From the Windows Start Menu at, select:
  - Start>All Programs>UAD Powered Plug-Ins>Remove UAD Powered Plug-Ins

### Macintosh



1. Launch the UAD Powered Plug-Ins Installer application. Click through the splash screen and license agreement.
2. When you get to the install screen, select "Uninstall" from the drop menu.
3. Click the "Uninstall" button. The software is removed.
4. Drag the UAD Meter & Control Panel icon out of the Dock.

**UAD software removal is complete.**

**Important:** *Power down the computer before removing any UAD cards!*



## CHAPTER 3

# UAD System Overview

### The UAD Environment

The complete UAD Powered Plug-Ins environment consists of many components. These components are:

- One or more UAD DSP hardware cards
- The UAD card drivers
- The UAD plug-ins
- The host computer system
- The plug-in host application software
- An audio I/O interface and its drivers

All these components operate together simultaneously within one computer to form the complete audio processing system.

The other UAD component is your account at [my.uaudio.com](http://my.uaudio.com) (page 41) and the UA online store, where UAD cards are registered, UAD vouchers are redeemed, and UAD plug-in licenses and authorizations are obtained. Although [my.uaudio.com](http://my.uaudio.com) is not required during normal system use, it is essential for initializing the overall UAD system because authorization is required to use UAD-Powered Plug-Ins (see “[Authorization Overview](#)” on page 42).

### The UAD Hardware

The UAD DSP (Digital Signal Processing) hardware cards provide the “power” behind UAD Powered Plug-Ins. Most of the UAD plug-ins use extremely complex algorithms to provide the quality sound and accurate modeling Universal Audio is famous for. The UAD processor engines are significantly more optimized to perform the complex DSP routines required for these algorithms than a standard desktop computer CPU can deliver.

Two main UAD card “families” are available: UAD-2 and UAD-1. Each card family has its own set of drivers which are specified during UAD software installation. All UAD card types can be used in either Windows or Macintosh computers that meet the system requirements (the cards are identical for both OS platforms).

**Note:** Multiple UAD hardware types can be used concurrently in the same computer. For details, see [Chapter 5, “Using Multiple UAD Cards.”](#)

## UAD-2 Family



UAD-2 is our second-generation UAD DSP card that offers many improvements over the UAD-1, most notably significantly more DSP horsepower and lower latencies.

All UAD-2 cards use the PCI-Express (PCIe) architecture. UAD-2's are “x1” PCIe cards. Up to four UAD-2 cards can be run concurrently in one system.

### Solo/Duo/Quad

Three different UAD-2 cards are available, the only functional difference between them is the number of DSP chips on each card: Solo (one DSP), Duo (two DSP's), and Quad (four DSP's). One Quad offers approximately 10 times the processing power of UAD-1.



Each UAD-2 DSP provides approximately 2.5x the processing power of the UAD-1. When comparing the processing power of UAD-2 to UAD-1, a range is given because there are many variables that affect UAD-2 DSP loads (such as plug-in type, host system, etc). Therefore, a single direct comparison cannot be made.

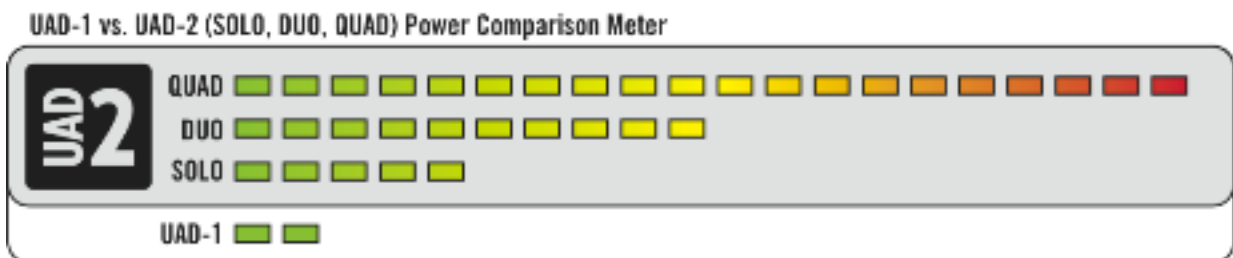

### UAD-2 Bundles

Each UAD-2 card type is available in three different retail packages to best accommodate your budget and processing requirements. All UAD-2 products include the “Mix Essentials” plug-ins so you can get great sound right out of the box, and a “good as cash” voucher for purchasing optional plug-ins.

## UAD-1 Family



The UAD-1 card family includes UAD-1, UAD-1e, and UAD-Xpander. All are functionally identical and have the same processing power.

The UAD-1 family includes products for use with PCI/PCI-X, PCIe, and ExpressCard expansion slots. Up to four UAD-1 cards can be run concurrently in one system.

### UAD-1

The UAD-1 uses PCI connectivity. It can only be used in PCI or PCI-X slots.

### UAD-1e

The UAD-1e uses PCI Express connectivity. It can only be used in PCIe slots. UAD-1e's are "x1" PCIe cards.

### UAD-Xpander & Xtenda

The UAD-Xpander is a UAD-1e card housed in an external chassis that interfaces to the computer using an ExpressCard expansion slot.

UAD-Xpander has special instructions for installation, connectivity, and use. See the UAD-Xpander chapter for complete details.

The UAD-Xtenda is an optional ExpressCard-to-PCIe adapter card that enables the UAD-Xpander to be used in desktop computers that have PCIe expansion slots. The UAD-Xpander/Xtenda system provides a convenient way to switch the same UAD-Xpander unit between desktop and notebook computers.



### Mackie UAD-1

The Mackie card is a UAD-1. Mackie was the worldwide distributor of UAD Powered Plug-Ins for its first two years on the market. Universal Audio has been the developer and manufacturer of UAD Powered Plug-Ins hardware and software since its inception.

## The UAD Software

The UAD Powered Plug-Ins software consists of the UAD installer, the UAD plug-ins, the UAD Meter & Control Panel application, the UAD card drivers, and the user documentation.

### Installer



The UAD Powered Plug-Ins software installer contains all the UAD software components (plug-ins, drivers, and documentation) and copies them to disk during installation. There is one UAD software installer for each OS platform (Windows and Macintosh). The UAD software installer is identical for all UAD hardware variations.

### Powered Plug-Ins



Powered Plug-ins are the VST, RTAS, and Audio Units plug-in files that are loaded within the host application. The plug-ins are where the graphical user interface (GUI) is seen (Figure 16 on page 73) and where the various control parameters can be manipulated to achieve the desired result.

The UAD software installer always installs the complete suite of all available Powered Plug-Ins. All of the installed UAD plug-ins may not be licensed however. The included licenses depends on the retail package bundle (see “Bundled Plug-Ins” on page 42).

### Optional Plug-Ins

Most UAD plug-ins require optional licenses to run without restrictions. Optional plug-in licenses are obtained at [my.uaudio.com](http://my.uaudio.com), the Universal Audio online store. Licenses can be purchased separately, or they can be purchased with “vouchers” that are bundled in most retail packages.

#### Demo Mode

UAD plug-ins that are unlicensed can be run in Demo Mode in a 14-day trial period without any functional restrictions. See [page 45](#) for details.

#### Vouchers and Licenses

Your account at the [my.uaudio.com](http://my.uaudio.com) online store is where bundled Powered Plug-In vouchers are redeemed and where additional licenses can be purchased. See [Chapter 4, “My.uaudio.com”](#) for details.

**Note:** When you purchase an optional license, you don’t download that individual plug-in. Instead, you download a newer authorization, which enables the plug-in file that is already installed.

## UAD Meter & Control Panel



The UAD Meter & Control Panel ([page 54](#)) is a utility application that is used to monitor and configure UAD card resources. It has two main windows: the UAD Meter, and the UAD Control Panel.

The UAD Meter window ([Figure 7 on page 54](#)) displays the current DSP, program, and memory status of the UAD hardware in realtime. The UAD Control Panel window ([page 57](#)) has multiple panels that display and modify various system, plug-in, and global configuration parameters.

## UAD Drivers

The UAD card device drivers are the low-level system software files that instruct the host computer system on how to communicate with the UAD card(s). The UAD drivers are loaded during system startup so the UAD cards are ready to be used when the plug-in host application is launched.

In addition to instructing the OS on how to control the UAD hardware, the driver acts as a software “middleman” between the host application and the UAD hardware. The host application uses the driver to route UAD signals in the DAW.

Each UAD card family (UAD-2 or UAD-1) has its own set of drivers. One or both are specified during UAD software installation, depending on which card type(s) you have installed.

### UAD Buffers and Latency

The UAD drivers use “buffers” to shuttle audio signals to and from the card. This means the digital data is transferred in small batches instead of continuously. Buffering induces a very small audio latency (delay) that is inherent in most digital audio systems and can be detected in certain situations.

UAD latency is managed automatically by most host applications and can be reduced to undetectable levels in the UAD-2 (see “[LiveTrack Mode](#)” on [page 76](#)). Latency and buffers are discussed in greater detail in [Chapter 9](#), “[UAD Delay Compensation](#).”

## User Documentation



Various instructional and technical resources are available for installing, using, and troubleshooting UAD Powered Plug-Ins. UAD documentation is available in written, video, and online formats. For details about user documentation, see “[Documentation Overview](#)” on [page 16](#).

## The DAW Environment

The digital audio workstation (“DAW”) environment is an overall system where audio production takes place, either with or without UAD Powered Plug-Ins. The UAD system is an add-on to the computer-based DAW that can dramatically improve the sonic quality and performance of the DAW, while still working entirely from within the DAW.



A computer-based DAW consists of the host computer hardware and its operating system (“OS”) software, the plug-in host application (DAW software), and an audio input/output interface and its drivers.

### Host Computer

The host computer is the system that the host DAW application software runs on and the UAD cards are installed into. The host computer must meet minimum technical requirements and have one or more compatible expansion slots to use with UAD hardware. See “[System Requirements](#)” on page 21 for complete details.

#### Operating System



The host computer runs an operating system, either Windows or Mac OS X, that defines the OS “platform” of the system. UAD Powered Plug-Ins is a cross-platform product that is (for all practical purposes) functionally identical on Windows and Macintosh computers.

### Host Application

The plug-in host application is the software DAW environment where audio recording, playback, mixing, and other production functions are controlled. UAD plug-ins are accessed and operated from within the host software application.

Each host application has a unique feature set and different methods of operation, including how to use plug-ins. However, once UAD plug-ins are loaded, UAD plug-in operation is the same in all host applications.

Each host application has its own set of system requirements. In addition to the UAD-specific system requirements, the host computer must meet the host application system requirements.

Because the host application environment is integral to the UAD system but is completely out of our control, we cannot claim compatibility with all hosts that may support use of the UAD plug-in formats. See [“Supported Hosts” on page 21](#) for complete details.

## Plug-In Formats

UAD Powered Plug-Ins includes support for VST, RTAS, and Audio Units plug-in formats. These formats define the software protocols that the host application uses for plug-in processing.

UAD Powered Plug-Ins operations are (for all practical purposes) functionally identical in all three plug-in formats. The format of the installed UAD plug-in files are specified during UAD software installation.

### VST

The VST (“Virtual Studio Technology”) plug-in format is developed by Steinberg and is supported by various Windows and Macintosh host applications.



### RTAS

The RTAS (“Real-Time Audio Suite”) plug-in format is developed by Digidesign and is supported by Pro Tools host applications on Windows and Macintosh platforms.



### Audio Units

The Audio Units (“AU”) plug-in format protocol was developed by Apple and is supported by various host applications on the Macintosh platform only.



Audio Units

## Audio Interface

The audio input/output (“I/O”) interface is how audio signals get into and out of the host computer. An audio interface is a hardware+driver device that can have analog or digital I/O, or both. The interface is usually where the analog-to-digital (“A/D”) and digital-to-analog (“D/A”) audio conversions take place.

## I/O Drivers

The audio interface is a hardware device that requires a software device driver for the host computer OS. In addition to instructing the OS on how to control the interface hardware, the driver acts as a software “middleman” between the host application and the I/O ports. The host application uses the driver to access the I/O for signal routings.

## I/O Buffers and Latency

Like the UAD card, audio interface driver also uses “buffers” to shuttle audio signals to and from the I/O (see [“UAD Buffers and Latency” on page 37](#)).

Smaller I/O buffer settings produce lower latencies which is useful when monitoring tracks while recording performances, but usually results in a higher host computer CPU load since the system has to work harder transferring data. Latency and buffers are discussed in greater detail in [Chapter 9, “UAD Delay Compensation.”](#)

## My.uaudio.com

My.uaudio.com is the UA online store, where UAD cards are registered to your account and authorization files can be obtained. Bundled plug-in vouchers are redeemed at the store and optional plug-in licenses can be purchased there as well. For complete details about my.uaudio.com, including accounts, registration, purchasing plug-ins at the online store, and more, see [Chapter 4, “My.uaudio.com.”](#)

## Authorization

Finally, all UAD plug-ins must be authorized before they can be used. Authorization is accomplished by simply clicking the “Authorize Plug-Ins...” button ([page 61](#)) in the UAD Meter & Control Panel. For complete details about the authorization system, see [“Authorization Overview” on page 42](#).



## CHAPTER 4

# My.uaudio.com

My.uaudio.com is the Universal Audio online store where UAD cards are registered to your account and UAD plug-in authorizations are obtained. Bundled plug-in vouchers are redeemed at the store and optional plug-in licenses can be purchased at my.uaudio as well. This chapter provides details about UAD plug-in authorization and licensing, and the my.uaudio.com store.

**Important:** All UAD plug-ins must be authorized before they can be used. Authorization is accomplished by clicking the “Authorize Plug-Ins...” button (page 61) in the UAD Meter & Control Panel. For instructions, see “Authorize Plug-Ins Procedure” on page 27. For complete details, see “Authorization Overview” on page 42.



Figure 5. My.uaudio.com

### Optional Plug-Ins

Most UAD Powered Plug-Ins require optional licenses to run without restrictions. Optional plug-in licenses are obtained at my.uaudio.com, the Universal Audio online store. Licenses can be purchased separately (page 48), or they can be purchased with “vouchers” that are bundled in most retail packages.

### Retail Packages

The UAD cards are available in a variety of retail packages. The difference between each package (besides the UAD card itself) is the selection of plug-ins that are included. Each package includes a set of bundled plug-ins, and a voucher that can be redeemed at my.uaudio.com for UAD plug-in licenses.

**Bundled Plug-Ins** UAD plug-ins that are bundled with the UAD card are automatically licensed when the card is registered. This includes the “Mix Essentials” (plug-ins that come with all cards) as well as bundled optional plug-ins. After registration, the authorization file must be loaded.

**Note:** UAD cards must be authorized to run bundled (included) plug-ins. See “Authorization Overview” on page 42 for details.

**Vouchers** Vouchers included in UAD retail packages have dollar values that are as “good as cash” for buying UAD plug-ins at my.uaudio.com. Vouchers are applied to your my.uaudio.com account automatically when you register your card by clicking the “Authorize Plug-ins button...” button. After registration, the voucher dollar amount is in your account as a credit, ready to be applied to your store purchase.

**Coupons** Like vouchers, coupons are as “good as cash” and are redeemed for UAD plug-ins at my.uaudio.com. Unlike vouchers however, coupons expire after a limited time period. Coupons are used for promotional offers only; they are not included in retail packages.

Coupons are a great reason to subscribe to promotional announcements. Email subscription preferences are specified on your “My Profile” page at my.uaudio.com (see “My Profile” on page 47).

**Plug-Ins are already installed**

The UAD software installer always installs the complete suite of available UAD plug-ins to the hard drive during installation. Therefore when you purchase an optional license, you don’t download that individual plug-in. Instead, you download a newer authorization file, which enables the plug-in file that is already installed.

**Important:** Older versions of the UAD software may not include all the latest UAD plug-ins. To ensure all UAD plug-ins are installed, and for optimum performance, we recommend updating to the latest UAD version. See “Check for Updates” on page 58.

## Authorization Overview

All UAD plug-ins must be authorized before they can be used. Authorization is accomplished by clicking the “Authorize Plug-Ins...” button in the UAD Meter & Control Panel, then loading the downloaded authorization file.

## QuickStart Video

The QuickStart DVD ([page 18](#)) contains a tutorial video on UAD authorization. The tutorial is also online at:

- <http://www.uaudio.com/support/UAD>

## Procedure

This section is a detailed overview of the entire UAD authorization system. For the step-by-step authorization instructions, see “[Authorize Plug-Ins Procedure](#)” on [page 27](#) in [Chapter 2, “UAD Installation.”](#)

**Note:** *Without authorization, UAD plug-ins can be enabled to run for 14 days without functional limitations in a timed demo mode (see “[Demo Mode](#)” on [page 45](#)).*

Your UAD card must be registered at [my.uaudio.com](http://my.uaudio.com) to download an authorization file, and you need a [my.uaudio.com](http://my.uaudio.com) account to register the card. As of UAD v5.0, these procedures are significantly simplified.

## Authorize Plug-Ins

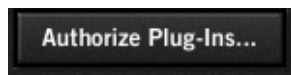

The registration/account/authorization process isn't as complicated as it may seem. The entire routine involves simply clicking the “[Authorize Plug-ins...](#)” button ([page 61](#)) in the UAD Control Panel. Clicking the button automatically registers the installed UAD cards, generates the authorization, and downloads it to disk.

Then just drag the file to any UAD Meter & Control Panel icon and you're ready to use UAD Powered Plug-Ins. When authorizing, you'll be prompted to log into your account if you aren't already, and if you don't already have an account, you'll be prompted create one.

## Authorization File

The authorization file, which is obtained by clicking the “[Authorize Plug-Ins...](#)” button ([page 61](#)), contains the license key(s) that enable UAD plug-ins to run on associated UAD cards. The authorization file is generated at [my.uaudio.com](http://my.uaudio.com) then downloaded to the local hard drive automatically.

## .uad/.uad2

The downloaded authorization files have either the `uad` or `uad2` file extension. “.uad” files are for UAD-1-only systems, while “.uad2” files are for UAD-2-only and mixed UAD-1/UAD-2 systems. When mentioned in the documentation, “.uad” refers to both `.uad` and `.uad2` files.

## Loading

To load a downloaded authorization file, just drag-drop it onto any UAD Meter & Control Panel application icon/shortcut/alias (see [Figure 3](#) on [page 29](#)).

## My Systems

The UAD cards and plug-ins that you own and can authorize can be found in your My Systems page at [my.uaudio.com](http://my.uaudio.com). My Systems keeps track of which UAD cards are in which computer, and the authorization status of each UAD plug-in.

My Systems is managed automatically by [my.uaudio.com](http://my.uaudio.com) and the UAD software. When “Authorize Plug-Ins...” is clicked, cards in the host system are added to My Systems. When an authorization file is downloaded, it reflects the current state of My Systems.

## System

All the UAD cards installed in a single host computer system, and the UAD plug-in license status for those cards, is referred to as a “System” (formally known as “Group”) on the My Systems page at [my.uaudio.com](http://my.uaudio.com). When you click the Authorize Plug-Ins...” button, UAD cards in the host computer are automatically registered and added to a System.

The UAD hardware identification numbers for each UAD card in a single host computer are stored in the same System. Authorization files generated at [my.uaudio.com](http://my.uaudio.com) are constrained to only authorize the licensed UAD plug-ins running on the UAD cards in the same System. The same authorization file authorizes all the cards and plug-ins in the host computer.

If you register a UAD card that is in a second host computer using the same [my.uaudio](http://my.uaudio.com) account, a second System is automatically created at My Systems. In accordance with the [“Plug-In License Policy” on page 50](#), you can’t have UAD cards from two separate computers in the same System. Each System generates a unique authorization file.

## Authorization Notes

- UAD cards must be authorized to run bundled (included) plug-ins. See [“Authorization Overview” on page 42](#) for details.
- Without authorization, UAD plug-ins can be enabled to run for 14 days without functional limitations in a timed demo mode (see [“Demo Mode” on page 45](#)).
- Older versions of the UAD software may not include all the latest UAD plug-ins. To ensure all UAD plug-ins are installed, and for optimum performance, we recommend updating to the latest UAD version. See [“Check for Updates” on page 58](#).

- Optional plug-ins are contained within the UAD software installer, not the .uad authorization file. Download and install the latest UAD software version to ensure the optional plug-ins that you are authorizing are installed.
- The .uad/.uad2 authorization file contains plug-in license keys for the specific UAD cards in each computer group at [My Systems](#). The file will not authorize any other UAD cards.
- An authorization file is not associated to the host computer or the UAD installer in any way. Instead, it is associated with the UAD cards at [My Systems](#) (it's the UAD hardware that is authorized, not the UAD plug-ins or computer).
- (UAD-2 only) During authorization, the UAD plug-in license state is stored on the UAD-2 card. If the UAD-2 is moved to another computer, it is not necessary to reload an authorization file.
- (UAD-1 only) If a UAD-1 card is installed into a different system, an authorization file must be loaded on the different computer. The auth file can be one obtained on the previous computer, or via Authorize Plug-Ins... button.

## Demo Mode

All unlicensed UAD plug-ins include a free 14-day trial evaluation period. When the demonstration mode is activated, the plug-in will run without functional limitations for 14 days. Demo mode can be activated once only. After the demo trial period has expired, demo mode cannot be activated again on the same UAD card.

If an unlicensed plug-in is loaded and its demo has never been started, a dialog appears with instructions to start the demo and the option to visit the online store to purchase the license. If you don't start the demo or purchase a license, the plug-in interface appears and can be manipulated, but audio is not processed by the plug-in.

**Important:** *The 14 day demo period can only be activated once, and cannot be stopped or restarted during this period! We recommend you do not activate demo mode until you have the time to thoroughly check out its sound and functionality.*

## Demo Activation **To activate demo mode:**

1. Ensure UAD Powered Plug-Ins version 5.0 or higher is already installed and configured properly (see [Chapter 2, "UAD Installation"](#)).

2. Launch the UAD Meter & Control Panel application (page 55).
3. Select "Plug-Ins..." from the Control Panel Menu (page 57). The UAD Plug-Ins panel (Figure 11 on page 63) appears.
4. Click the **Start Demo** button for the desired UAD plug-in. A confirmation window appears and the timed demo can be activated or demo activation can be cancelled.

**The timed demo is activated for 14 days.**

### Demo Notes

- (UAD-2 only) In addition to the Plug-Ins panel, Demo mode can also be activated directly from the UAD Toolbar (see page 74).
- (UAD-1 only) Demos cannot be started if any UAD-1 plug-ins are running. If they are, a message instructing you to quit the host application is displayed.
- Manipulating the computer's system date and time will result in a decreased demo period.

### UA Online Store

The UA online store at [my.uaudio.com](http://my.uaudio.com) (Figure 6 on page 46) is where optional UAD plug-in licenses and other UA products can be purchased. Vouchers and promotional coupons are also redeemed here. All UAD card registrations and plug-in authorizations are managed here.

[My.uaudio.com](http://my.uaudio.com) can be accessed from most pages at [www.uaudio.com](http://www.uaudio.com) by clicking the link in at the upper left of a webpage. The direct URL for the [my.uaudio.com](http://my.uaudio.com) online store is: <http://my.uaudio.com>.

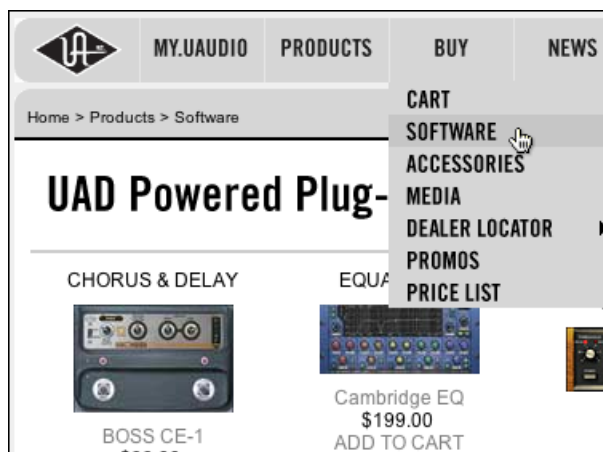

Figure 6. The UA online store at [my.uaudio.com](http://my.uaudio.com)

## **Registration**

Registration at my.uaudio.com is required for all UAD users to obtain UAD card authorizations, redeem vouchers, purchase optional UAD plug-in licenses, get software updates, and receive customer support. It is also an opportunity for you to inform us of your system details so we can serve you better, and for us to keep you informed about important updates and new product announcements.

## **Account**

A my.uaudio.com account is required to use UAD- Powered Plug-Ins, because UAD plug-ins must be authorized for use, and authorization can only occur after the UAD card is registered to an account. UAD registration also entitles you to free UAD [Customer Support](#) and special promotional offers.

### **Creation**

The first time you visit my.uaudio.com you are prompted to create your account. Your email address is your account login. You'll be prompted to enter your name, address, and password, and set your email notification preferences.

### **Login**

When you revisit my.uaudio.com, you are prompted to login to your account. Your email address is your account login; the password was specified when the account was created. If you forget your password you can have the store email your password to you. You have the option to stay logged in (via a browser cookie) if desired so you don't have to keep entering the credentials.

## **My Profile**

"My Profile" is where product registration details such as name and mailing address are stored and edited. Your email subscription preferences are also set here so you can choose whether or not to receive email announcements for our webzine and promotional offers.

Your email address is your my.uaudio.com account identifier and login. You can change the email address (and the my.uaudio.com login) on the My Profile page. We respect your privacy and your email address will never be shared with any other parties.

## Buying Plug-Ins

To obtain optional UAD plug-in licenses, simply visit [my.uaudio.com](http://my.uaudio.com), browse the complete line of plug-ins at our secure online store, and complete your purchase with several payment options or use the voucher credit that was applied during card registration.

Lots of product information such as features, specifications, audio/video demos, and reviews are available on the plug-in product pages at the store to help you make your buying decisions.

### Purchase Procedure

#### To purchase and authorize an optional UAD plug-in:

1. Login to your [Account](#) at [my.uaudio.com](http://my.uaudio.com). Your email address is your login.
2. Click the “Products” menu and browse the available plug-in selections.
3. Add the items you wish to purchase to your shopping cart.
4. Click the shopping cart icon when ready to proceed to checkout. The payment page appears.
5. Select payment method: credit card, Paypal, personal check, or voucher.
6. Add any promotional discount coupons, then click Continue. The order confirmation page appears.
7. Verify the order confirmation page, then click Confirm Order *once*. The transaction is processed, and the “order complete” page appears.
8. Purchased UAD plug-in licenses are issued immediately to [My Systems](#). Any authorization file downloaded after this point contains the new license.
9. Download a new [Authorization File](#) by clicking the [Authorize Plug-ins button](#) in the [UAD Meter & Control Panel](#).
10. Drag-drop the authorization file onto any UAD Meter & Control Panel application icon/shortcut/alias. (Windows only: or drag to an open Meter/Control Panel window).
11. The authorization is loaded onto the UAD card(s) and after a few seconds the “Authorizations Updated Successfully” window appears.

**The purchased UAD plug-in is now licensed and fully authorized. Enjoy!**



## **Transferring UAD cards and licenses**

Ownership of UAD cards and UAD plug-in licenses can be transferred from one my.uaudio.com account to another to accommodate the used equipment marketplace. Certain restrictions apply. Please visit the UAD transfer page for instructions, policies, and FAQ:

- <http://my.uaudio.com/support/transfer.html>

### **Transfer Video**

Our Demonstration Videos page has a video about UAD card transfers:

- <http://www.uaudio.com/support/software/UAD/tips/starting.html>

## CHAPTER 5

# Using Multiple UAD Cards

### Overview

When multiple UAD cards are installed in the host computer, the DSP and memory load of the cards are automatically balanced dynamically as UAD plug-ins are loaded and unloaded. With multiple cards, there is no major difference in operating procedures, except that more Powered Plug-Ins can be loaded simultaneously in the session.

### Mixed UAD System

The UAD drivers support up to four UAD-2 and four UAD-1 cards running in the same host computer system concurrently. The cards can be any combination of UAD-2 family and/or UAD-1 family cards, up to four of each, for a total of up to eight UAD cards in one computer.

#### UAD-Xpander

The UAD-Xpander can be used as part of a the multicard desktop system via the UAD-Xtenda ExpressCard to PCIe adapter card, which is optionally available at [my.uaudio.com](http://my.uaudio.com). The UAD-Xpander contains a single UAD-1e card and will count as one of the four UAD-1 cards that will run concurrently.



### Plug-In License Policy

The Universal Audio End-User License Agreement (“EULA”) on [page 3](#) grants you the non-exclusive right to use UAD Powered Plug-Ins on a single computer at a single location.

Since you can run up to four of each card type (UAD-2 and UAD-1) in the same computer, each individual UAD plug-in license will authorize all the cards in one computer (up to eight cards, four of each type).

However, as an example, if you have four UAD cards but run a dual-card system in two separate computers, you are required to purchase separate licenses for the second system.

## Authorizing Multiple Cards

When you buy an optional plug-in, your purchased license is valid for all the cards in the computer. The license is tied to the specific UAD cards in the [System](#) (see [page 44](#)) when the license was purchased. For example, if you have two cards when you purchase a plug-in, your authorization file will authorize both cards.

If you have one card during purchase then later acquire another card(s), you will need to download a new authorization file containing the licenses for the new card(s). However, there is no charge for the new authorization file containing the additional licenses. Your purchase buys licenses for all the cards in the same computer.

Each individual card must be authorized in order to run optional plug-ins, however multiple installed cards are authorized simultaneously. If one card is authorized then another card is added without downloading a new authorization, the optional plug-in will only load on the previously authorized card. To obtain a new authorization file for additional cards, use the “Authorize Plug-ins...” button ([page 61](#)) in the UAD Meter & Control Panel.

## Power Requirement

Each UAD card draws power from the expansion slot bus that it is installed in (PCI, PCI-X, or PCIe). The total power draw of all the installed cards must not exceed the power that can be adequately delivered by the host computer.

The UAD card power requirements are listed in [Table 2 on page 52](#). These figures are measurements of the actual power draw for these devices when running at full DSP load.

**Important:** If insufficient power is available to the UAD cards, unpredictable behavior may result.

Table 2. UAD Power Requirements by Card Type

UAD Card Type	Maximum Power Draw
UAD-1	15 Watts
UAD-1e	9 Watts
UAD-2 Solo	3.5 Watts
UAD-2 Duo	5 Watts
UAD-2 Quad	7 Watts

## Windows



The PCI specification provides for up to 25W per device, however some host systems don't provide (or require) this much power. When designing a computer DAW system, a common rule of thumb is to provide an extra 50%–100% of headroom over the estimated maximum total power draw of all components in the system. Don't skimp on the power supply unit! When building a custom system a quality sufficiently-rated PSU is critical for system stability.

## Multicard DSP Loading

DSP loading in a multicard system behaves the same as in a single UAD-2 Duo or Quad system, and is managed automatically by the UAD software. See ["DSP Loading Information" on page 80](#) for details.

## Card Info Display

UAD DSP and memory resources used for each installed card, and the ability to enable/disable individual cards, is displayed in the System Information window. See ["System Information Panel" on page 58](#) for complete details.

## Disabling Cards

Individual UAD cards can be disabled using the Card Enabled function (see [page 60](#)). This can be useful, for example, if creating a session on a system with multiple cards that will be transferred to a system with fewer cards.

Cards are disabled only while the UAD Meter & Control Panel application open. When the UAD Meter & Control Panel is quit, disabled cards are re-enabled.

**Note:** For optimum results, quit any applications using UAD plug-ins before disabling/enabling cards.

If a UAD Powered Plug-In is loaded on a card then that card is subsequently disabled, an error message will be displayed. This occurs because a plug-in is assigned to a card when it is first instantiated. It stays assigned to the same card until it is de-instantiated (for example, removed from the insert slot).

## Host CPU

Using more than one card can cause a slight increase in host CPU requirements, so disabling unused cards can help you squeeze in a bit more host performance if you need it. Using additional devices on the PCI bus requires host resources, so running 15 UAD plug-ins on three cards at five plug-ins per card may require more host CPU than running the same 15 UAD plug-ins on one card.

For example, if you are trying to minimize latency during tracking by using a smaller buffer size (which will increase host CPU) and need a bit more host CPU, disabling one or more UAD cards during tracking may give the extra pinch of host CPU you need. The buffer size can then be increased and the UAD card(s) re-enabled for mixing.

## CHAPTER 6

# UAD Meter & Control Panel

### Overview



The UAD Meter & Control Panel application is used to monitor UAD card resources, confirm the UAD system is operating properly, and configure the global UAD Powered Plug-Ins system parameters.

The UAD Meter window displays the current DSP, program, and memory status of the UAD hardware in real-time. Figure 7 shows how the UAD Meter appears on when a UAD-1 and UAD-2 are installed together in the same system. When only one card type is installed, only that card type is displayed.

The UAD Control Panel Window (page 57) has multiple panels that display and modify various system, plug-in, and configuration parameters.

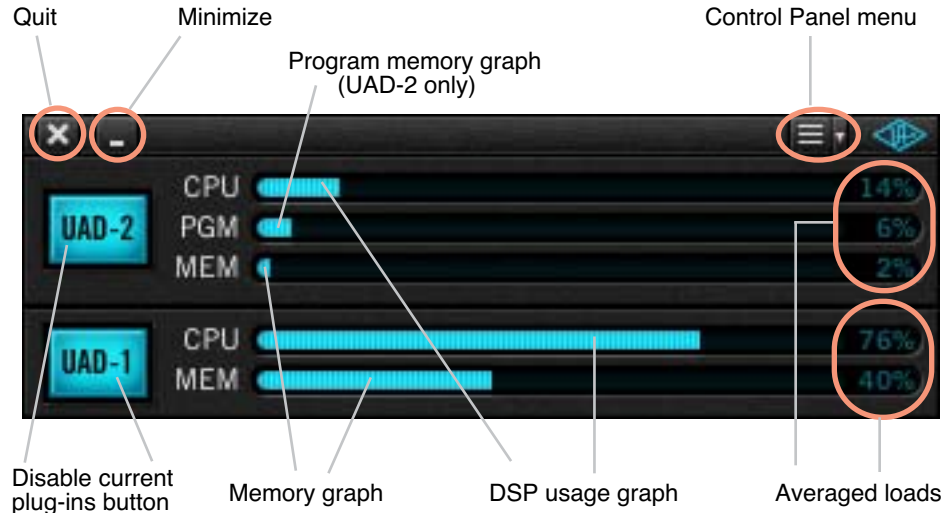

Figure 7. The UAD Meter window

**Note:** The Quit, Minimize, and Menu button positions shown in Figure 4 are as they appear on Macintosh systems. The button positions are reversed on Windows systems, reflecting the conventions for each OS platform.

## Launching the UAD Meter & Control Panel Application

### Windows



To launch the UAD Meter in Windows:

1. Double-click the UAD Meter & Control Panel shortcut that was placed on the Desktop during installation. OR,
2. Access the application from the Start Menu at Programs/UAD Powered Plug-Ins/UAD Meter & Control Panel. OR,
3. Double-click the executable file on the hard drive located at C:\Program Files\Universal Audio\Powered Plug-Ins\UADPerfMon.exe.

### Macintosh



To launch the UAD Meter in Mac OS X:

1. Single-click the UAD Meter & Control Panel alias that was optionally placed in the Dock during installation. OR,
2. Double-click the UAD Meter & Control Panel application that was installed to Applications/Powered Plug-Ins Tools during installation.

## Using the UAD Meter

The UAD Meter & Control Panel can be launched or quit at any time. It does not need to be open or active to use UAD Powered Plug-Ins. It is completely independent and does not require a host application. You can move the UAD Meter to a convenient location on your screen by dragging its window title bar.

### Always On Top

The UAD Meter window can be set to normal or “Always on top” (floating) view mode. In normal mode, the window can be covered by windows of the foreground application. When in ‘Always on top’ mode, the Meter window always “floats” on top of other windows, even when other applications are in the foreground, so you can always see the meter and access the disable buttons (page 56). This setting is saved when the meter is quit.

To enable Always on top mode, click the control panel menu in the Meter window title bar (Figure 8 on page 58) and select “Always on top.” The mode is active when a checkbox appears next to the item in the menu.

**Note:** If “No Cards Found” appears in the UAD Meter window instead of the expected buttons and gauges, then the UAD drivers are not communicating with the UAD hardware. If this occurs, double-check hardware and software installations and/or contact customer support.

## UAD Meter Elements

Refer to [Figure 7 on page 54](#) for these element descriptions.

### Title Bar

The title bar at the top of the UAD Meter window contains buttons to quit the UAD Meter & Control panel application and minimize the UAD Meter window, and a drop-menu to access the Control Panel window functions.

### Disable Current



The Disable Current button disables all UAD Powered Plug-Ins that are currently running. This enables you to add new UAD plug-ins for offline processing, or easily compare the sound of the processed and unprocessed audio.



When the button glows blue, UAD plug-ins are active. Click the button to disable the active plug-ins; the button changes to black with blue lettering. New UAD plug-ins can then be added. Click the button again to re-activate all UAD plug-ins.

**Note:** *Disable Current stays active only while the UAD Meter & Control Panel application is open. When the UAD Meter & Control Panel is quit, Disable Current is deactivated.*

### Resource Gauges

The UAD resource loads are displayed in the UAD Meter window, which are constantly updated in realtime even when the UAD Meter is not the foreground application. This allows you to monitor UAD loads as needed, for example when deciding which UAD plug-ins to load, based upon how much DSP is available.

The UAD resources are displayed as bar graphs and as percentages.

#### Averaged Loads

The load for each gauge represents the average for each card type. For example, if one UAD-2 Quad is installed, the UAD-2 DSP load is an average of the four DSP processors on the Quad. If two UAD-2 Quads are installed, then the eight processors are averaged. Similarly, if multiple UAD-1 cards are installed, then the UAD-1 loads represent the average of all UAD-1 cards.

#### Individual Loads

The loads of individual cards in a multicard setup (or the individual DSP loads in a multi-DSP UAD-2 card) can be viewed in the UAD System Information panel (see [page 58](#)).



**DSP** The DSP gauges display the amount of digital signal processing resources that are being used by the UAD Powered Plug-Ins algorithms. DSP is the primary hardware “juice” that powers the UAD Powered Plug-Ins algorithms.

When UAD plug-ins are disabled, DSP requirements are decreased.

**Program** This resource shows how much “program memory” is in use by the UAD-2. Program memory is an on-chip memory that is specific to the UAD-2 DSP processor(s) and is used for certain UAD plug-in resources.

Each unique UAD-2 plug-in uses a bit of program memory. If many different UAD-2 plug-ins are loaded simultaneously, it is possible for this resource to run out before DSP overload occurs. This point is considered and factored in by the automatic UAD-2 load balancing routines.

**Note:** *The UAD-1 uses a different processor which does not have program memory. The PGM gauges are not displayed for UAD-1 cards.*

**Memory** The Memory gauges indicate the percentage of UAD RAM that is currently in use. It indicates the total available UAD memory available, regardless of the number of UAD processors that are installed.

Memory is used for echo, delay lines, reverb, and similar spatial processing. When UAD plug-ins are disabled, memory requirements are *not* decreased. In this case, memory remains loaded so that reverb tails and delay lines are not cut off when the plug-in is disabled (if supported by the host).

## UAD Control Panel

The UAD Control Panel is where detailed system information is displayed and global UAD Powered Plug-Ins settings are modified. The UAD Control panel has four panels, organized into similar areas of functionality: System Information, Plug-Ins, Configuration, and Help & Support.

### Accessing the Control Panels

The main UAD Control Panel window is accessed from the UAD Meter window. To open the Control Panel, click the menu button in the UAD Meter window title bar (Figure 8 on page 58). After clicking the menu button, the available functions are listed in the drop menu.

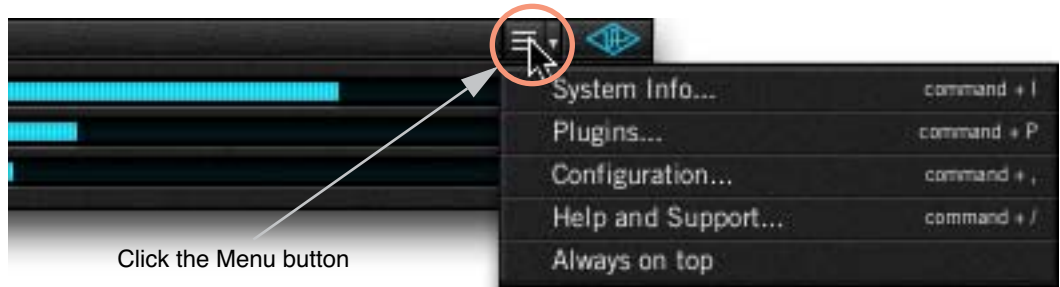

Figure 8. Accessing the UAD Control Panel

Once the main UAD Control Panel window is open, the individual window panels are accessed by clicking the title buttons (Figure 9).

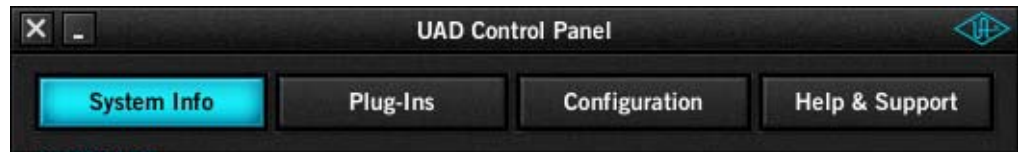

Figure 9. The Control Panel window panel buttons

## System Information Panel

The System Information panel (Figure 10 on page 59) displays detailed UAD software and hardware information and contains several useful buttons.

### Software Section

#### Version String

The currently installed UAD Powered Plug-Ins software version is displayed.

**Important:** The UAD driver and plug-in versions must match. If they don't, a "driver mismatch" error will occur when attempting to process audio. If this occurs, you must reinstall and/or reauthorize the UAD software.

#### Check for Updates

This button links to the current software download page at the UAD support website so you can quickly see if the latest available version matches the installed version. We recommend running the latest version of UAD Powered Plug-Ins for maximum stability and the latest features, such as new plug-ins.

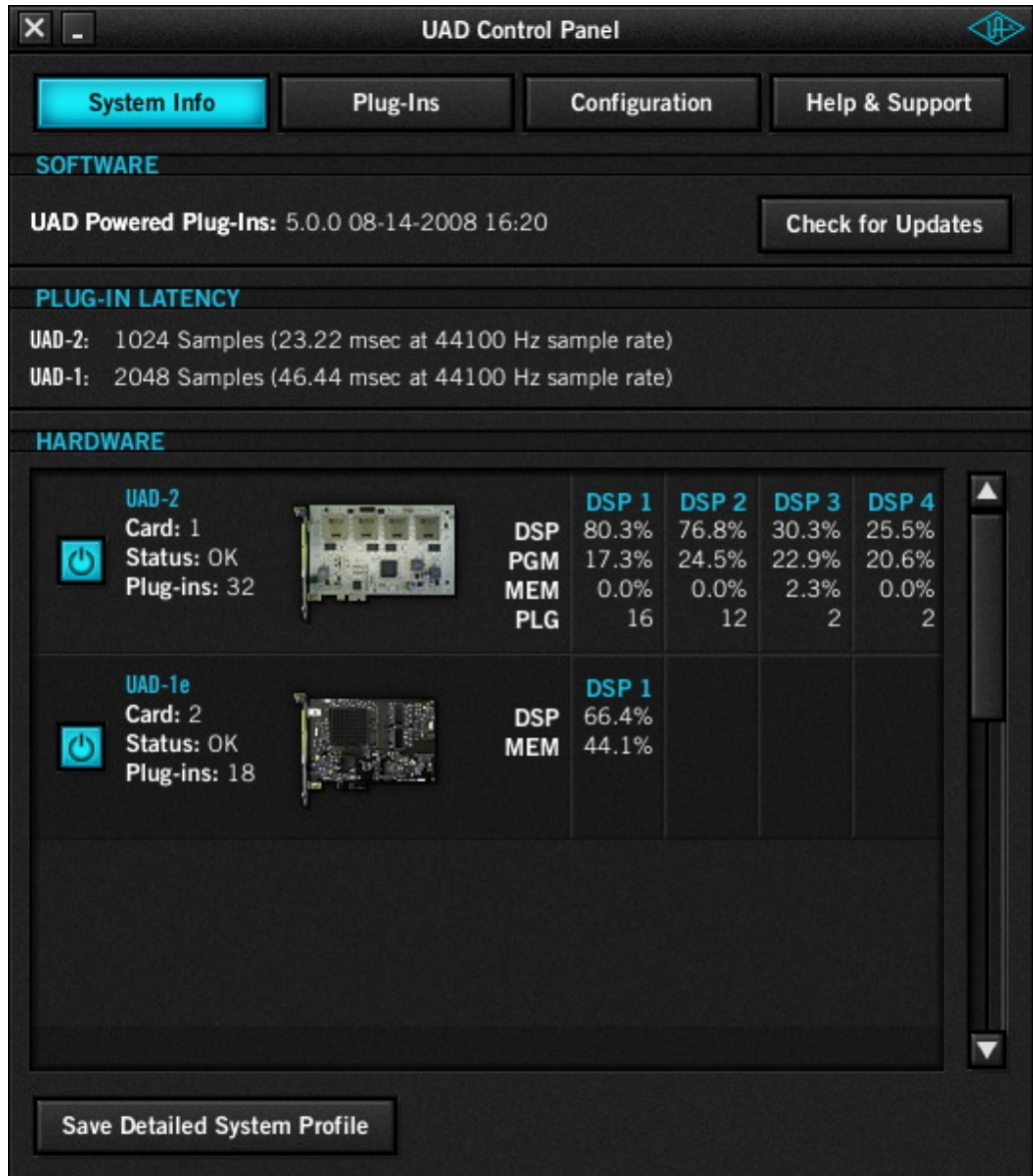

Figure 10. The UAD System Information panel

### Plug-In Latency Section

UAD plug-in latency for each card type (UAD-2 and UAD-1) is displayed here. The calculation is based on the audio I/O interface buffer size and the sample rate. The window uses this information to calculate and display the resulting latency in samples and milliseconds.

The buffering methods used by UAD-2 and UAD-1 drivers are different for the two card types, which is why the latency differs between the cards.

**Note:** Displayed latency does not reflect the actual lowered latency value when LiveTrack mode (page 76) is active.

## UAD-2

The displayed latency is the audio I/O interface buffer size when Extra Buffering (page 67) is off. When Extra Buffering is on, the displayed latency is the audio I/O interface buffer size plus 64 samples.

## UAD-1

The displayed latency is twice the audio I/O interface buffer size.

**Note:** The displayed sample latency number does not include the extra samples produced by upsampled UAD plug-ins. For more detailed information about the extra samples and latency, see “Compensating Upsampled Plug-Ins” on page 95.

### Hardware Section

Detailed information about each UAD card and its DSP is displayed in the Hardware area (Figure 10 on page 59). If you have several cards installed, use the scrollbar to see the other cards.

### Card Status

For each installed card type (UAD-2 and UAD-1), a small picture of the hardware and its status is displayed. When the card displays Status: OK the hardware is operating properly. The total number of UAD plug-ins loaded on each card is also displayed here.

### Card Enabled



Individual UAD cards can be disabled using the Card Enabled button.

This can be useful, for example, if creating a session on a system with multiple cards that will be transferred to a system with fewer cards, to streamline the performance of the host system when multiple cards are not needed, or to manually balance loads on UAD-1-only multicard systems.



Click the button to disable an individual card. The card is enabled when the button is blue. For additional information regarding multicard use, see Chapter 5, “Using Multiple UAD Cards.”

Cards remain disabled only while the UAD Meter & Control Panel application is open. When the UAD Meter & Control Panel is quit, disabled cards are re-enabled.

**Note:** Disabling cards does not disable plug-ins already running on the card; it only prevents additional plug-ins from being loaded onto it.

**Important:** For optimum results, quit any host applications using UAD plug-ins before disabling/enabling cards.

## DSP Load

If more than one UAD DSP is installed, information for each of the processors is displayed. DSP, Program (“PGM”), and Memory (“MEM”) loads are displayed as a percentage of total available load for that processor.

The number of UAD plug-ins (“PLG”) running on each individual processor is also displayed (not available for UAD-1).

## Save Detailed System Profile

Clicking this button will generate a detailed system profile and prompt you for a location to save the file to disk. This file contains an even greater level of detail than the System Information panel, which can be useful for troubleshooting or if UA Customer Support requests this document when providing assistance.

The profile lists the version strings of the individual UAD software components, installed card type(s) with serial and hardware ID numbers, host computer information, and detailed authorization status for all UAD plug-ins.

## Plug-Ins Panel

The Plug-Ins panel ([Figure 11 on page 63](#)) displays the current authorization status of all UAD plug-ins. This is also where you can activate plug-in Demo Mode (“[UA Online Store](#)” on [page 46](#)) and configure UAD plug-ins to run on a specific card. Use the scrollbar to view plug-ins that are not visible in the list.

## Authorize Plug-ins button



This important button links directly to your account at the UA online store to automatically generate and download an authorization file for your UAD plug-ins. If you do not already have an account, you are redirected to the registration page to create one.

**Important:** *UAD plug-ins require authorization before they can be used. For detailed information, see “[Authorization Overview](#)” on [page 42](#). Without authorization, UAD plug-ins can be enabled to run for 14 days without functional limitations in a timed demo mode (see “[Demo Mode](#)” on [page 45](#)).*

The complete procedure for UAD card authorization is detailed in [Chapter 2, “UAD Installation.”](#) See “[Authorize Plug-Ins Procedure](#)” on [page 27](#) for complete step-by-step instructions. If the UAD computer is not connected to the internet, see “” on [page 29](#).

## Plug-In Column

All currently installed UAD Powered Plug-Ins are displayed in the Plug-In column. Use the scrollbar to view the entire list if necessary.

## Status Column

The Status column reflects the current state of each UAD plug-in. The status depends on which card (UAD-2 or UAD-1) the plug-in is running on; the status may change if the “Run On” card is changed ([page 64](#)). After the authorization file is loaded (“[Authorization Overview](#)” on [page 42](#)), the status will show one of the following:

### **Authorized for all cards**

The plug-in is fully licensed and authorized to run on all cards in the system.

### **Start Demo**

The demo period has not been started for the plug-in. Click the “START DEMO” button to begin the 14-day trial period.

### **Demo (days remaining)**

If the 14-day trial period has been activated but is not yet expired, the number of days remaining is displayed here in green text.

**Important:** *The 14-day demo period can only be activated once, and cannot be stopped or restarted during this period! We recommend you do not activate demo mode until you have the time to thoroughly check out its sound and functionality. See “[Demo Mode](#)” on [page 45](#) for detailed information.*

### **Not available for UAD-2**

The plug-in has not been ported to the UAD-2 and is available to run on UAD-1 cards only. In this case, the Run On menu is unavailable.

### **No UAD-1 cards found**

This is displayed for unported UAD-1 plug-ins when both card types were selected during software installation, but only the UAD-2 is currently installed. In this case, the Run On menu is unavailable.



Figure 11. The UAD Plug-Ins panel

### Run On Column

The Run On column indicates which card (UAD-2 or UAD-1) the specified plug-in will load onto. When both UAD-2 and UAD-1 are installed, you can select between them with the Run On menu in order to better manage your DSP resources.

For example, you could run low-DSP plug-ins such as the UAD CS-1 on the UAD-1, while specifying that resource-hungry plug-ins such as Neve 33609 run on the UAD-2.

### Run On Menu



The Run On column contains a drop menu for each plug-in. Specify which card type (UAD-2 or UAD-1) the plug-in will load onto with the Run On drop menu. Click the disclosure triangle to see the menu, then drag and release on the desired card type.

**Tip:** Hold Shift when specifying a card to quickly change all plug-ins in the list to that card type.

If plug-ins for only one card type (UAD-2 or UAD-1) are installed, the disclosure triangle is not displayed and the drop menu is unavailable.

**Note:** The Run On menu should not be used dynamically; it is designed to be “set and forget” because the value is not stored within sessions.

### Help Column



Click the Help button (“?”) to open the UADManual.pdf (the file you are reading now).

### Buy Column



If the computer is connected to the internet, clicking Buy links to the plug-in product pages at the UA online store. See “[UA Online Store](#)” on [page 46](#) for purchasing details.

## Configuration Panel

The UAD Configuration Panel is where most of the global UAD settings and preferences are specified. Refer to [Figure 12 on page 65](#) for the parameter descriptions.

The parameters that are displayed in the Configuration Panel are dependent upon the UAD hardware that is currently installed and the OS platform (Windows or Mac). For example, if you have only UAD-2 cards installed in a Windows system, you will not see the UAD-1 or Macintosh parameters.



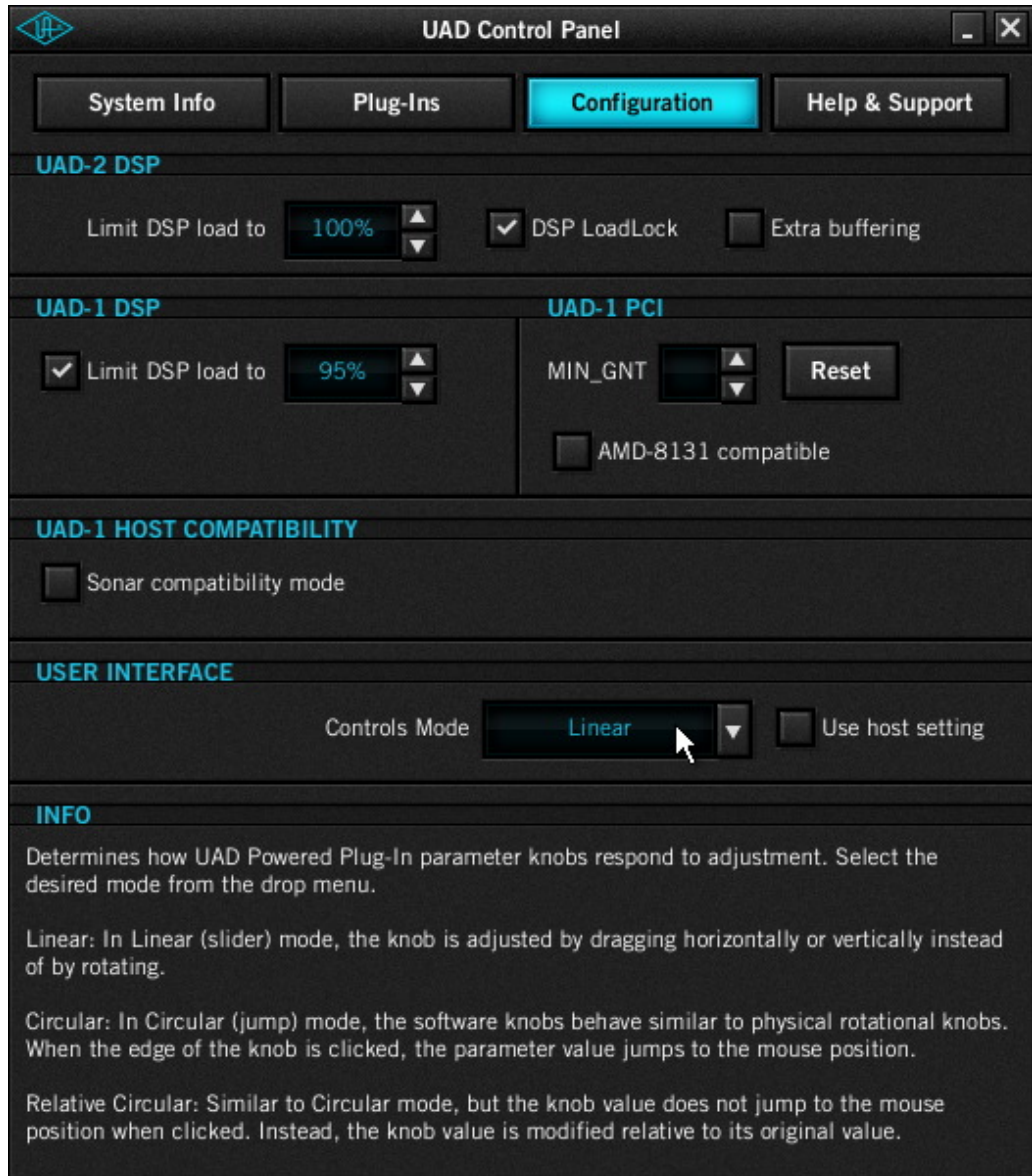

Figure 12. The UAD Configuration panel

## DSP Load Limiting Overview

Without UAD Powered Plug-Ins installed, overloading the host system with native (host based) plug-ins can cause dropouts and possibly system lockup. Steinberg hosts, for example, provide a switch that allows you to trade latency for stability when the system is overloaded. Similarly, the UAD DSP load cannot exceed 100% without unpredictable behavior.

With the Limit DSP Load feature, the UAD DSP can also be limited so the load cannot exceed 100%, thereby increasing overall system stability in high load situations. With very heavy UAD loads, DSP load limiting may also improve host CPU performance.

There are many variables that affect DSP load (sample rate, buffer size, parameter values, mono/stereo, automation, host system, etc). Although these variables are taken into account, the resulting measurement cannot be absolutely accurate. This is due to variations in system configurations, specifically PCI/PCIe bus loading which is impossible to predict. Systems that are heavily loaded due to the presence of other devices or suboptimal configuration may cause additional DSP loading that cannot be predicted by the UAD plug-in load calculator. The DSP load limit should be reduced in this case.

It is possible for certain (non-typical) conditions to be met where another UAD plug-in can't be added, even when the UAD Meter says you should have DSP available when compared to the DSP Load Limit value.

**Note:** *When Limit DSP Load is enabled and the DSP load limit is exceeded when instantiating a new UAD plug-in, an overload message will appear and the plug-in toolbar will display "DISABLED." Even though its interface will load, the plug-in will not process audio.*

## UAD-2 DSP

Settings in this area apply to the UAD-2 card only. If no UAD-2 card(s) are installed, these settings are not displayed.

## Limit DSP Load

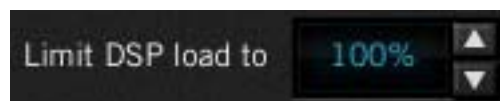

This setting determines the maximum UAD DSP load. If performance issues such as overloads, dropouts, stuttering, and/or crackles persist, change the UAD DSP load value by clicking the triangles to the right of the percentage display.

UAD-2 DSP load limiting is always on; 100% is the maximum value.

Unlike the UAD-2, which has a different architecture, load limiting on UAD-1 can be disabled altogether by unticking the checkbox. However, enabling UAD-1 DSP load limiting is recommended for optimum performance.

## UAD-2 DSP LoadLock

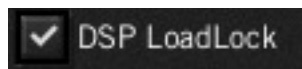

DSP LoadLock (UAD-2 only) reserves the maximum UAD-2 DSP load required by each plug-in, even if certain plug-in features are disabled. This ensures there will always be enough DSP if those features are later enabled, or when automating parameters that affect the DSP load.

Disabling LoadLock increases available UAD-2 DSP by turning off unused features in certain plug-ins, but may cause problems with previously saved sessions that had all plug-in features enabled, or when automating parameters that affect the DSP load.

Enabling DSP LoadLock is recommended for optimum performance. Disable LoadLock when you need to squeeze in that extra bit of DSP resources.

## UAD-2 Extra Buffering

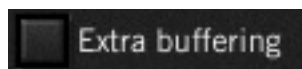

Extra Buffering adds an additional 64 samples of buffering for increased host application compatibility. Applications that are known to require Extra Buffering include Sony Vegas, Acid, and Soundforge, and Sonar Cakewalk.

In other hosts, you can disable this mode to reduce latency. If your application is incompatible with reduced latency when Extra Buffering is off, a dialog will be displayed indicating that Extra Buffering is required.

## UAD-1 PCI

Settings in this area apply to the UAD-1 card only. If no UAD-1 card(s) are installed, these settings are not displayed.

## MIN\_GNT

MIN\_GNT is a low-level system setting that affects PCI bandwidth. If you are experiencing crackles or dropouts, our technical support team may recommend a different value. Clicking the Reset button sets the value to 64, which is recommended for most systems.

**Important:** *System performance can be adversely affected by changing this value. MIN\_GNT does NOT affect audio latency in any way!*

## AMD-8131 Mode

If your computer uses the AMD-8131 PCI controller chipset, check the “AMD-8131 Compatible” box. This will improve UAD performance on these systems. For the new setting to take effect, you must reset the audio interface using one of the following methods:

- Close the re-open the session
- Stop then restart the audio engine
- Modify or reset the audio device settings

AMD-8131 Compatible Mode is only required when the card is attached directly to an AMD-8131 PCI bus. If the UAD is in an external PCI expansion chassis, this mode should be disabled (unchecked).

**Important:** Do not enable AMD-8131 Mode unless your computer uses this PCI controller chipset, or performance may be compromised.

### Macintosh G5 Systems

The AMD-8131 chipset is used in most Macintosh G5 systems. The UAD software automatically determines when it is running on a G5 with AMD-8131 and sets the mode appropriately. If the UAD is in an external PCI expansion chassis, AMD-8131 mode should be unchecked.

## Host Compatibility

### Windows



#### Sonar Compatibility Mode

Tick the Sonar Compatibility Mode checkbox to improve UAD-1 plug-in performance when used with Cakewalk Sonar. This mode should be disabled when using different hosts, otherwise audio degradation could occur.

### Macintosh



#### Release all DSP resources on Audio Unit bypass

Some Audio Unit hosts dynamically bypass plug-ins when they are not being used during playback, for example when no audio is present at the current playback position. During this dynamic bypassing, UAD plug-ins stay loaded on the card, which reduces glitches in playback.

Checking the “Release all DSP resources on AudioUnit bypass” option will unload UAD plug-ins from the card during dynamic bypassing. When the option is checked, UAD DSP usage may be reduced during dynamic bypassing, but the possibility of glitching during playback is increased.

**Note:** This setting affects the Audio Units platform only.

### Macintosh



#### Force Logic to use “live mode” for tracks with UAD-1 plug-ins

When UAD-1 plug-ins and Logic 7.2.1 (and higher) are used together and this setting is checked, all Logic tracks with UAD-1 plug-ins are forced into “Live Mode” and latency is reduced. Reduced latency is useful for tracking when Logic's Software Monitoring feature is active.

When Live Mode is active, UAD-1 latency is twice the hardware I/O buffer size. In Logic versions prior to 7.2.1 (and later versions when live mode is disabled), UAD-1 latency is determined by the larger of the hardware I/O buffer size and the Process Buffer Range setting within Logic. Since the minimum Process Buffer Range setting (“Small”) in Logic 7 corresponds to 512 samples, this means the minimum possible UAD-1 latency is 1024 samples (the current latency is displayed in the UAD Meter System Information panel) when Live Mode is inactive.

**Note:** *On multi-processor machines Live Mode forces all plug-ins on tracks with UAD-1 plug-ins (and any aux/buses fed by those tracks) to run on one processor only. To allow host plug-ins to run on all processors under these conditions, deactivate this setting.*

## User Interface Settings

### Controls Mode

This setting determines how UAD Powered Plug-In parameter knobs respond to adjustment. Three control modes are offered: Circular, Relative Circular, and Linear. Select the desired mode from the drop menu.

**Note:** *To increase resolution when in adjusting rotary controls in circular and relative circular modes, increase the radius of the mouse relative to the knob while dragging (i.e. move the mouse farther away from the knob while dragging in a circular motion).*

### Linear (slider)

In Linear mode, the knob is adjusted by dragging horizontally or vertically instead of by rotating. This behavior is similar to moving a physical fader.

### Circular (jump)

In Circular mode, the software knobs behave similar to physical rotary knobs. Values are changed by clicking on the knob then rotating in a circular direction. When the edge of the knob is clicked, the parameter value jumps to the mouse position.

### Relative Circular (grab)

Relative Circular mode operates similar to Circular mode, but the knob value does not jump to the mouse position when clicked. Instead, the knob value is modified relative to its original value.

In this mode you can click anywhere on the knob to make an adjustment originating at the original value. You don't have to click on the current knob position.

### Use Host Mode

When Use Host Mode is checked, the control mode set within the host application preferences is used if this feature is supported by the host. This setting forces the host to override the control mode set in the UAD user interface settings.

**Note:** When Use Host Mode is checked, the UAD Meter user interface settings have no effect unless control mode is NOT supported by the host.

### Macintosh



### Toggle initial value modifier

Holding the specified modifier key while clicking a parameter control will toggle between the value of the control when the editor was opened and its last edited value. This feature is not supported under Windows.

This parameter also affects the “select + click” modifier. For a complete list of keyboard shortcuts, see [“Shortcuts” on page 79](#).

### Info Display

This area displays helpful text about parameters in the Configuration panel. Hover the mouse over a Configuration setting to view the text.

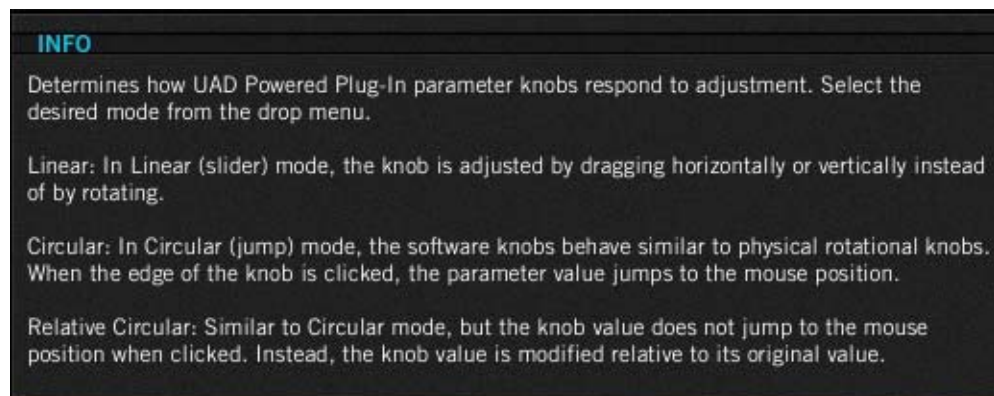

### Help & Support Panel

The Help & Support panel ([Figure 13](#)) contains numerous helpful weblinks to help you get the most out your UAD Powered Plug-Ins experience.

The button names are self-explanatory. Click a button to launch the URL in your default web browser (you must be connected to the internet to launch the web pages). If the UAD computer isn't online, most of the information is in the manual you're reading now; find it in Table of Contents, Index, or search.

“View User Manual” is the only button that doesn’t link to the internet. Instead, clicking this button opens the UAD User Manual (the file you’re reading now).

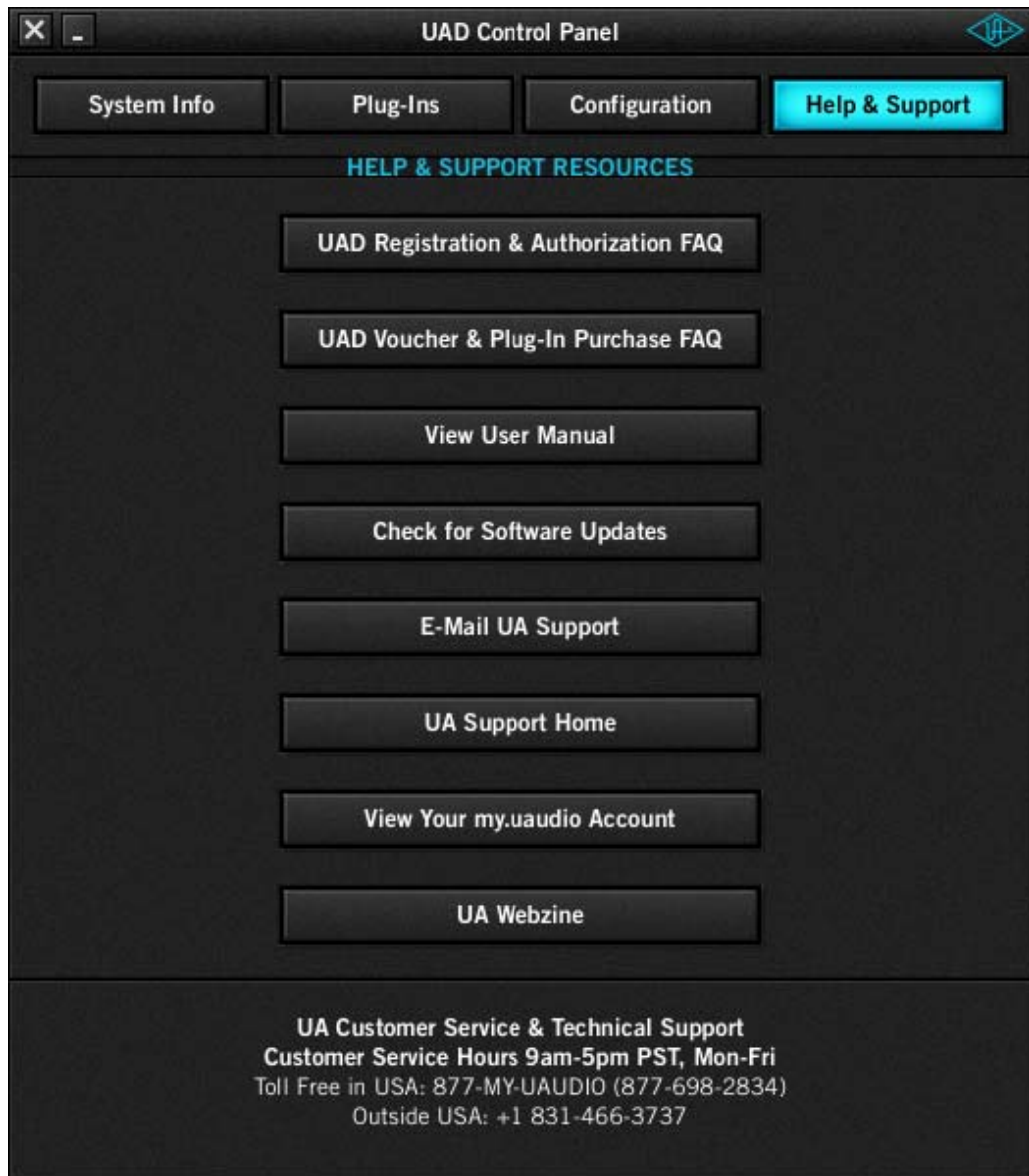

Figure 13. The UAD System Help & Support panel

## CHAPTER 7

# Using UAD Powered Plug-Ins

### Overview

Once the UAD card(s) and Powered Plug-Ins have been properly installed, the UAD Powered Plug-Ins are accessed and used just like any host-based plug-in. All UAD Powered Plug-Ins can run concurrently with each other and with host-based plug-ins simultaneously, in any combination.

Most UAD Powered Plug-Ins support up to 32-bit, 192KHz operation (exceptions: Plate 140, Precision Multiband, Nigel, Roland RE-201, and Neve 1073SE/1081SE/33609 cannot run at 176.4kHz and above on UAD-1). Resolution is limited only by the resolution of the host application. Please note that Powered Plug-Ins running at 96KHz use twice as much UAD DSP resources than those used at 48KHz, and so forth.

### Launching a UAD Powered Plug-In

Each host application has its own particular methods for instantiating (launching) a plug-in. Consult the host application documentation for specific instructions on loading and using plug-ins with the application.

### Cubase SX & Nuendo SX



Figure 14. Launching a UAD Powered Plug-In in Steinberg Cubase and Nuendo



## Logic Pro



Figure 15. Launching a UAD Powered Plug-In in Apple Logic Pro

## The UAD Plug-In Window

A typical UAD Powered Plug-In window is shown in Figure 16. The graphical user interface (GUI) typically contains several control parameters, for modifying the behavior of the plug-in, and display elements such as meters, for visual feedback. The UAD Toolbar is also displayed.



Figure 16. A typical UAD plug-in window

## Controls View

Some host applications have an alternate plug-in display mode feature called Controls View, Parameter Mode, or similar nomenclature. This mode typically displays the control parameters as a list with simple sliders, switches, and menus (the appearance is controlled by the host), which some users prefer. Consult the host documentation for how to display this view.



Figure 17. A UAD plug-in showing controls view

## UAD Toolbar

Below every UAD Powered Plug-In (when displayed in normal GUI view) is the UAD Toolbar (Figure 18). The Toolbar has several useful features that make using UAD plug-ins more convenient.

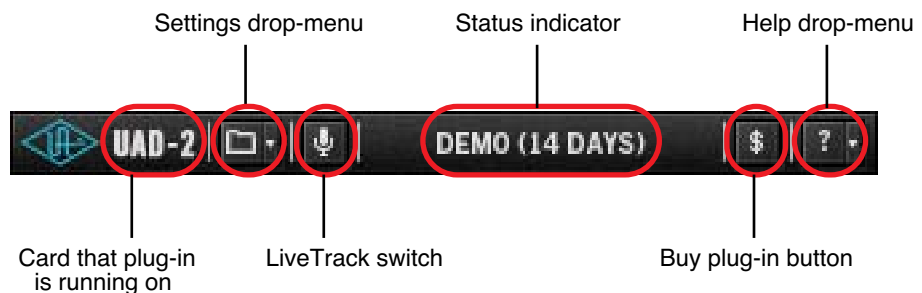

Figure 18. Anatomy of the UAD Toolbar

## Card Indicator



The text at the left of the Toolbar indicates which UAD card the plug-in is running on, either UAD-1 or UAD-2. If both cards are installed, you can specify which card the plug-in runs on (see “Run On Menu” on page 64).

## Settings Menu



The Settings menu provides a convenient way to manage your UAD plug-in parameter settings. To select the functions, click the folder icon in the Toolbar, then select an action from the drop-menu that appears.

The Settings load/save feature supports presets but not banks. To load and save banks, use the host's bank management feature (if available).

**Note:** *UAD plug-in settings are saved within a project session file by the host software, and settings are recalled when the project file is loaded. This occurs automatically without using the preset load/save feature.*

## Preset/Settings Compatibility

Load/save and copy/paste of parameter values between the same UAD plug-in type is supported. You can also load/save/copy/paste between "SE" and "full" plug-ins of the same type, for example between UAD Neve 33609 and UAD Neve 33609SE when you need to squeeze out a bit more DSP performance without losing your settings.

### Preset Families

Functions in the menu are also supported between "family" based plug-ins. For example, preset load/save and settings copy/paste are all interchangeable within the UAD CS-1 family, which includes CS-1, DM-1, DM-1L, EX-1, and RS-1. The Nigel family can share presets and settings as well.

## Load/Save Preset

When the Load Preset or Save Preset function is selected, the standard operating system load/save file dialogs are presented. Preset files can then be loaded (if the plug-in is the same type), or saved to any disk location.

### Default Preset Locations

When the load/save functions are used, the OS load/save file dialogs default to the standard UAD preset location. Although UAD presets can be loaded from (and saved to) any disk location, using the default location is a convenient method to organize all your presets in one location.

When saving, the Presets folder is created if it doesn't already exist. A subfolder with the UAD plug-in name is also created, so presets for the same plug-in are all in the same folder. When loading presets, the open file dialog looks inside the subfolder for that plug-in.

## Windows



The default preset location is inside the Presets folder, which is created within the folder specified during software installation. For example, if the default location was selected when running the installer, the location would be:

- C:\Program Files\Universal Audio\Powered Plugins\Presets

**Note:** This default location can be changed during installation; the new location will be remembered as the default.

## Macintosh



On Mac OS X systems, the default preset location is:

- Startup Disk/Library/Application Support/Universal Audio/Presets

## Copy/Paste Settings



Settings can be copied and pasted directly between UAD plug-ins (within the compatibility guidelines) without using the interim step of creating a preset file.

To copy/paste settings between UAD plug-ins, select Copy Settings from the drop-menu of the source plug-in, then select Paste Settings from the drop-menu of the destination plug-in.

**Note:** If the menu displays “Cannot Paste Settings” then settings were not copied first, or the paste destination is an incompatible plug-in.

## LiveTrack Mode

### Overview



LiveTrack Mode reduces latency on an active UAD-2 plug-in to the lowest possible amount. This feature is highly useful for monitoring processed audio when recording live performances.

**Note:** Due to differing architectures, this mode is not available with UAD-1.

Reduced latency in LiveTrack Mode is accomplished by circumventing the standard buffering processes. Normally, UAD-2 signal data is buffered at the audio interface I/O sample buffer size (such as 128, 512, or 1024 samples) which results in a processing delay.

In LiveTrack Mode, UAD-2 signal data is transferred and processed “immediately” instead of being buffered, resulting in reduced latency.

### Increased Host Loading using LiveTrack

When LiveTrack is active, host CPU loading increases. The host load is directly proportional to the DSP load of the UAD plug-in(s) in LiveTrack mode, however host CPU is never used for Powered Plug-in processing.

### Extra Latency using LiveTrack

When extra buffering is enabled (page 67) or when upsampled UAD plug-ins (page 95) are used with LiveTrack, latency is increased. Extra buffering adds 64 samples, and each upsampled plug-in using LiveTrack add the value from Table 7 on page 96.

**Note:** For more detailed information about latency and buffers, see Chapter 9, “UAD Delay Compensation”.

### LiveTrack Activation



To activate LiveTrack Mode, click the microphone icon in the UAD-2 Toolbar. The mode is active when the mic icon is red.

LiveTrack Mode can be activated simultaneously on multiple UAD-2 plug-ins. However, host system CPU loads will increase with each LiveTrack Mode instance.

### Status Indicator

The Status indicator (see Figure 18 on page 74) displays information about the current state of the plug-in. Each state is described below.

#### Start Demo



When “START DEMO” is displayed, the 14-day trial period for the particular plug-in has never been activated. Clicking this button will start the demonstration period (you can also start the demo in the Control Panel’s Plug-In Status column (page 62)).

#### Demo Active

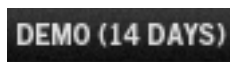

After starting the demo, and when the plug-in is still within the active 14-day trial period, the number of days remaining in demo mode is displayed here.

**Important:** The 14 day demo period can only be activated once, and cannot be stopped or restarted during this period! We recommend you do not activate demo mode until you have the opportunity to thoroughly check out its sound and functionality. See “Demo Mode” on page 45 for more information.

### Disabled



When “DISABLED” is displayed in red, the plug-in will not process audio. This can occur in two ways. Either the demo period has expired (click the Buy button!), or the UAD DSP is overloaded and there is not enough card resources to run the plug-in.

### Status Blank

When no text is displayed in the Status area, the plug-in is fully authorized (licensed) and operating normally. In this state, the Buy button is not displayed.

### Buy Button



When the plug-in is not fully licensed, the Buy button is displayed. If the computer is connected to the internet, clicking Buy links to the UA online store so you can purchase the license. See [“UA Online Store” on page 46](#) for purchasing details.

### Help Menu



The Help drop-menu contains a couple handy shortcuts for your convenience. To select the shortcuts, click the “question” icon in the Toolbar, then a shortcut from the drop-menu that appears.

Select “Manual” to open the UADManual.pdf (the file you are reading now). Select “Web Info” to visit the product pages for the plug-in on our website (requires internet connection).

## Adjusting Parameters

The parameter settings for each of the UAD Powered Plug-Ins can be adjusted to achieve a desired effect. Parameter values are easily modified by dragging sliders, rotating knobs, clicking switches and buttons, or by selecting values in a drop-menu. The functions of all parameters are detailed in later chapters.

The parameter adjustment style can be Circular, Relative Circular, or Linear. For more information, see [“User Interface Settings” on page 69](#).

**Note:** *To increase resolution when adjusting rotary controls in circular and relative circular modes, increase the radius of the mouse relative to the knob while dragging (i.e. move the mouse farther away from the knob while dragging).*

## Text Entry

Parameter values can be modified directly with text entry. To enter a parameter value using text entry, single-click the parameter value text. The text value will highlight, indicating it is ready to receive a new value. Type in a new value, then press Return, Enter, or Tab, or click outside of the text box. Press Esc if you want to revert to the prior setting without entering the new value.

Values entered via text entry are rounded to the closest significant digit. If an entered value is out of range, it will be ignored.

To enter time values, the units must be specified. m = milliseconds, and s = seconds. Examples: 400 milliseconds = .400s or 400m; 1.5 seconds = 1.5s or 1500m.

## Scroll Wheel

If your mouse has a scroll wheel, it can be used to adjust knob and slider controls if the host application supports this functionality. Place the mouse cursor over any knob or slider control to increment or decrement the parameter value with the scroll wheel.

## Keyboard Control (Macintosh)



If you control-click a control it selects that control for keyboard control. This is useful for when you're in circular mode, and you want to fine-adjust a control. Normally, clicking on a control in this mode makes the value jump to where you clicked. Control-clicking will select the control so that you can use the keyboard to adjust it, without making its value jump first.

## Shortcuts

Table 3 on page 80 lists the keyboard shortcuts that are available for modifying parameter values. When using keyboard shortcuts, the last edited control will be modified (or, on Macintosh, you can use control-click to select a different control as the target for keyboard shortcuts without changing the control's value).

**Note:** *Not all host applications support sending keystrokes to plug-ins.*

Table 3. Keyboard shortcuts

<b>Keyboard Action:</b>	<b>Result:</b>
Control + Click Parameter (Macintosh only)	Select parameter for keyboard control (without changing its value)
Shift + Drag	Fine Control
UpArrow RightArrow Shift + PageUp	Increment Fine
DownArrow LeftArrow Shift + PageDown	Decrement Fine
Shift + UpArrow Shift + RightArrow PageUp	Increment Coarse
Shift + DownArrow Shift + LeftArrow PageDown	Decrement Coarse
Home	Maximum
End	Minimum
Control + Click parameter (Windows) Modifier* + Click parameter (Macintosh) (*Modifier key set in Configuration Window)	Toggle initial editor setting (the value when the editor window was last opened)
Control + Shift + Click parameter (Windows) Modifier* + Shift + Click parameter (Mac) (*Modifier key set in Configuration Window)	Revert to initial editor setting (the value when the editor window was last opened)

## DSP Loading Information

The UAD cards feature either one (UAD-1 & UAD-2 Solo), two (UAD-2 Duo), or four (UAD-2 Quad) on-board DSP chips for processing Powered Plug-Ins.

In UAD-1-only systems, when there is more than one UAD-1 in the system, the UAD-1 card that has the lowest resource usage will receive the next Powered Plug-In load. Note that an individual UAD-1 plug-in cannot be split across two (or more) UAD-1 processors.

For example, let's say you have a two UAD-1 cards installed, the UAD Meter displays 90%, you load another UAD plug-in that requires 6% DSP, yet you get a "plug-in unable to load" message. This would occur if both cards are already at 95% (the meter shows the *total* available DSP, not the per-card DSP), so a 6% plug-in can't load.



Multi-DSP UAD-2 systems use significantly enhanced load balancing routines. UAD-2 plug-ins are always allocated as efficiently as possible, which is not necessarily on the DSP with the lowest resource usage.

### More Loading Notes

- UAD DSP usage is proportional to the host application sample rate and system PCI/PCIe bus speed. Therefore, more plug-ins can be used simultaneously in a 44.1K session than in a 96K session, and likewise a higher speed bus will use less DSP load than a slower bus.
- Bypassing individual components will conserve DSP on some UAD plug-ins. For example, bypassing the compressor in the EX-1 when only the EQ is in use, and/or bypassing any of the unused bands of the EX-1 EQ will use less UAD DSP.
- The UAD DSP resources required by each successive UAD Powered Plug-In instance will slightly decrease.
- A chart showing expected plug-in counts can be found on our website: <http://www.uaudio.com/support/software/UAD/charts.html>

### Host CPU Loads

- The host system memory and CPU are never used for Powered Plug-Ins processing. However, there will always be a small amount of load on the host CPU induced by data transfers and user interface operations. This is unavoidable when using a DSP card.
- When LiveTrack Mode is active, host CPU load is increased. See “[LiveTrack Mode](#)” on page 76 for details.

### Automation

Every UAD Powered Plug-In parameter can be automated if this feature is supported by the host application. Each host application has its own particular methods for automation. Consult the host application documentation for specific instructions on using automation with the application.

UAD Powered Plug-Ins reduce their DSP load when bypassed or disabled, but not their memory load. This feature allows for automatable load balancing of DSP power, and keeps the track delay constant to avoid on/off clicks.

**Note:** *If there is not enough DSP available when automating, the plug-in may not turn on. When this occurs, “DISABLED” is displayed in the UAD Toolbar.*

## External MIDI Control

UAD Powered Plug-In parameters can be controlled by an external MIDI controller, if this feature is supported by the host application. Each host application has its own particular methods for external MIDI control. Consult the host application documentation for specific instructions on using external MIDI control with the application.

analog ears | digital minds

## CHAPTER 8

# Tempo Sync

### Overview

The time-based parameters of several UAD Powered Plug-Ins can be synchronized to the tempo of the host application using the Tempo Sync feature.

When Tempo Sync is activated, the time-based parameters that are available for synchronization are changed to note duration values, and will sync to the tempo of the host application using the displayed note value.



Figure 19. The Tempo Sync feature within UAD DM-1L

**Note:** Not all host applications support Tempo Sync. In such hosts, the tempo sync features will not function.

### Tempo Sync Plug-Ins

Tempo Sync is supported in the UAD plug-ins listed in [Table 4](#).

Table 4. UAD Plug-Ins with Tempo Synchronization

UAD Roland RE-201	UAD Nigel
UAD CS-1	UAD Phasor
UAD DM-1	UAD ModFilter
UAD DM-1L	UAD TremModEcho
UAD RS-1	UAD Tremolo Fade

### Sync Activation

To activate Tempo Sync, click the “Sync” button within the plug-in interface. The Sync button “LED” will illuminate and the time parameters will change from a time-based display to a note value (see [Figure 19](#)).

**Note:** When Tempo Sync is activated, the plug-in will automatically switch the time or rate parameter(s) to the nearest available note value(s) given the range of the parameter in question and the current tempo.

## Available Note Values

The note values that are available for selection are listed in [Table 5 on page 84](#). The values are listed in musical notation as a division of measures. For example  $1/4$  = one quarter note,  $1/1$  = one whole note,  $4/1$  = four whole notes, and so forth.

The available note values were chosen to allow syncing to tempo in odd time signatures as well the common  $4/4$  time signature.

LFO rate parameters have their note values listed from longest to shortest, since long note values correspond to slow LFO rates.

Table 5. Tempo Sync available note values

$1/64D^*$	$1/8$	$5/8$	$4/1$	
$1/64$	$5/32^*$	$1/1T$	$5/1$	
$1/32T$	$1/4T$	$1/2D$	$6/1$	D = Dotted
$1/32$	$1/8D$	$1/1$	$8/1$	
$1/16T$	$1/4$	$5/4$	$9/1$	T = Triplet
$1/32D$	$5/16$	$1/1D$	$12/1$	
$1/16$	$1/2T$	$7/4$	$16/1$	* = RE-201 only
$1/8T$	$1/4D$	$2/1$		
$1/16D$	$1/2$	$3/1$		

A quarter note is always a quarter note, independent of the time signature. In different time signatures a quarter note can represent different numbers of musical beats (e.g.  $6/8$ ) or different fractions of a bar (e.g.  $5/4$ ). For example, say the time signature is  $6/8$  and the delay time tempo sync note value is  $1/4$ . If a sound occurs on beat one of the measure then its delay will occur on beat 3, which is  $1/4$  note (i.e. two 8th notes) later.

**Note:** The “beat” value in a sequencer’s BPM tempo setting always refers to a quarter note, independent of time signature.

## Range Limits

Some parameters in Tempo Sync mode cannot access the entire note value range in Table 4, because their maximum values would always be out of range above certain note values (assuming a maximum usable tempo of 300 BPM; 250BPM for Roland RE-201). These parameter limits are:

- DM-1, RS-1 time – 300ms: maximum 1/4D
- DM-1L time – 2400ms: maximum 3/1
- Nigel Echo time – 1200ms: maximum 1/1D
- Nigel Tremolo fade in/onset – 4000ms: maximum 5/1
- Roland RE-201 Head 1 range: 5/32 – 1/64
- Roland RE-201 Head 2 range: 1/4 – 1/32
- Roland RE-201 Head 3 range: 1/2T – 1/32D

## Entering Values

In addition to adjusting the parameter knob, the two following methods can be used for entering Tempo Sync values.

### Arrow Keys

After clicking the parameter to select it, the arrow keys can be used to scroll through available note values.

### Text Entry

Direct text entry is also available (see “Text Entry” on page 79). Any notation values can be entered (fraction or decimal), and the values are automatically converted to the nearest appropriate setting.

For example: If 3/4 or 6/8 is entered using text entry, 1/2D is displayed because a dotted half note equals three quarter notes, which is the duration of one measure in a time signature of 3/4 or 6/8. If 12/8 is entered with text entry, 1/1D is displayed because a dotted whole note equals six quarter notes, which is the duration of one measure in a time signature of 12/8 (or two measures in a time signature of 3/4 or 6/8).

This means you can create a tempo sync duration of one measure for any time signature by simply typing in the time signature (assuming there is a match in the beat table).

Similarly, if 1/12 is entered with text entry, 1/8T is displayed because an eighth note triplet is equivalent to one-twelfth of a measure (if in 4/4 time).

## Out of range

When a parameter note value is out of range of the current tempo note value, the note value is displayed in parentheses on a red background (Figure 20).



Figure 20. Tempo Sync note value display

## Modes with Tempo Sync

The UAD DM-1 and UAD DM-1L plug-ins (and DM-1 within CS-1) have a Mode menu (see “Mode Pop-up Menu” on page 188) that switches the plug-in operation between delay, chorus, and flanger mode. In these plug-ins, when the Mode is set to DualDelay and PingPong, the delay Time and modulation Rate parameters are simultaneously available for Tempo Sync.

However, when the plug-in is set to a Chorus or Flanger mode, only the Rate is available for Tempo Sync. This enables the more typical and musical chorus/flange effect by only syncing the modulation Rate to the tempo while the delay time remains constant.

In UAD Nigel (and the submodules within Nigel), there are several ModFilter modes that cannot be tempo-synchronized. Additionally, ModDelay does not sync to tempo when the LFO is set to one of the “Trem” types. In these cases, the Sync enable switch is greyed out and cannot be enabled.

Additionally, the UAD Nigel/TremFade Fade In and Onset parameters have a setting of “None” which allows you to set these parameters to the corresponding normal “None” value when in Tempo Sync mode. The Rate parameter has an “Off” setting which corresponds to a normal value of 0 Hz.

## Roland RE-201 Sync



When the RE-201 is in Tempo Sync mode, note values can be imprecise due to the fixed tape head relationships. Values that are imprecise approximations (but are within the available delay time range) are displayed with a “+” or “-” symbol. The leading head in the current mode is accurately synced; the other values are based on the fixed tape head relationship. Note that when a parameter note value is out of range of the current tempo note value, the note value flashes (instead of in parentheses on a red background as in [Figure 20](#)).

## CHAPTER 9

# UAD Delay Compensation

### Latency & Delay Compensation

When UAD Powered Plug-Ins are used, audio data to be processed by a Powered Plug-In is sent by the host application to the UAD card. The audio is then processed by the UAD card and sent back to the host application. This back-and-forth shuffling of audio data is called “buffering” and it produces a latency (delay) in the audio signal being processed.

Latency is inherent in digital audio systems and it can be detected in certain situations. Latency time in a DAW is usually determined by the sample rate and audio I/O interface device driver buffer size settings.

If this latency is not compensated, the processed audio will not be perfectly synchronized with unprocessed audio. Fortunately, most audio plug-in host applications automatically compensate for this latency when plug-ins are used on track inserts by simply turning on the “Plug-in Delay Compensation” (PDC) or similar Preferences setting. Many hosts even provide “Full Plug-in Delay Compensation” throughout the entire signal path, including sends, groups, and buses.

UAD latency and plug-in delay compensation is managed automatically by host applications that implement plug-in delay compensation. Additionally, latency can be reduced to undetectable levels in the UAD-2 by bypassing host buffering altogether (see “LiveTrack Mode” on page 76).

### Host PDC Implementation

Table 6 on page 89 lists the current implementation of plug-in delay compensation in the officially supported UAD host applications. The displayed version number is the version in which PDC was implemented; higher versions also have PDC.

**Important:** *Delay compensation is fully automatic and requires no user intervention when UAD Powered Plug-Ins are used in hosts that support “Full plug-in Delay Compensation.”*



Table 6. Host Application plug-in delay compensation Implementations

Full PDC	Platform	Partial PDC	Platform
Steinberg Cubase SX 2	Win / Mac	Logic 5, 6, 7.0	Win / Mac
Steinberg Nuendo 2	Win / Mac		
Steinberg Wavelab 6	Windows	<b>No PDC</b>	
Sony Vegas 6	Windows	Digidesign Pro Tools LE	Win / Mac
Sony ACID Pro 5	Windows	Image-Line FL Studio	Windows
Sony Sound Forge 8	Windows	Celemony Melodyne	Win / Mac
Ableton Live 5	Win / Mac	Tascam GigaStudio 3	Windows
Cakewalk Sonar 5	Windows	MOTU Digital Performer 4.12	Macintosh
Magix Samplitude 7	Windows	BIAS Peak 4	Macintosh
Mackie Traktion	Windows	Apple Waveburner	Macintosh
Adobe Audition 2	Windows	Apple Garageband	Macintosh
Apple Logic 7.1	Macintosh	Apple Soundtrack	Macintosh
MOTU Digital Performer 4.5	Macintosh	Apple Final Cut Pro	Macintosh
Pro Tools TDM HD 6.7*	Macintosh		
BIAS Peak 5	Macintosh	*Limited PDC; maximum compensation is 4096 samples	
Spark XL 2.8	Macintosh		
Audiofile Wave Editor 1.3	Macintosh		

**Important:** The following sections about delay compensation apply only when using hosts that do NOT implement full plug-in delay compensation!

Depending on the host application implementation, the delay compensation feature may not provide automatic compensation when UAD Powered Plug-Ins are inserted on sends, groups, or buses. In this situation, the solution is to use the UAD Delay Compensator plug-in (“UAD Delay Compensator” on page 90).

UAD Delay Compensator should not be used in situations where the host application provides delay compensation automatically, such as on track inserts. Some host applications provide fully automatic delay compensation throughout the entire signal path. UAD DelayComp is not needed at all in such hosts (see Table 6).

These explanations of delay compensation apply primarily to playback only. For more information about using UAD Powered Plug-Ins for live performance and during recording, see “Live Processing” on page 99.

For information about using UAD Powered Plug-Ins on audio tracks while simultaneously running MIDI tracks, see “Live Processing” on page 99.

## Host Application Settings

For optimum results, the “Plug-in Delay Compensation” option setting should be enabled in the host application. This will provide automatic latency compensation when UAD plug-ins are used on track inserts (and sends/groups/buses if full compensation is supported), so the UAD Delay-Comp will not have to be used. This option is usually found in the audio or plug-in preferences window. The specific location of the setting for this option within some popular applications is as follows:

- Cubase 5.x: Options Menu>Audio Setup>System...
- Nuendo 1.x, Cubase SX 1.x: File Menu>Preferences>VST
- Cubase SX 2/3, Nuendo 2/3: Always on.  
(Steinberg’s Constrain Delay Compensation feature can be used to disable delay compensation on individual plug-ins: Devices Menu>Plug-in Information)
- Emagic Logic Audio (PC): Options Menu>Preferences>Audio Preferences...
- Apple Logic Pro: Preferences>Audio...
- MOTU Digital Performer 4.5+: Setup menu>Configure Audio System>Configure Studio Settings...
- Cakewalk Sonar, Sony applications, Mackie Traktion: Automatic.  
(No preference for enabling/disabling other than turning off or removing plug-ins that require delay compensation.)
- Samplitude: Options Menu>Project Properties>Mixer Setup...  
(Project independent; session file must be open to configure)
- Ableton Live: Options>Delay Compensation

## UAD Delay Compensator

The UAD Delay Compensator (DelayComp for short) is a simple plug-in which can be used to synchronize unprocessed tracks with those that are processed by UAD Powered Plug-Ins. It provides a mechanism of delay compensation for situations when the host application does not implement automatic plug-in latency compensation, such as on sends, groups, and buses (see [Table 6 on page 89](#)).

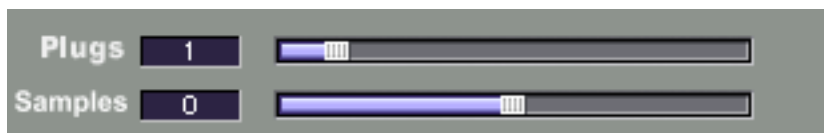

Figure 21. The UAD Delay Compensator plug-in window

The UAD Delay Compensator acts as a dummy UAD Powered Plug-In, automatically introducing the necessary amount of latency for tracks which are *NOT* processed by UAD Powered Plug-Ins. It requires no DSP from the UAD card and allows you specify the number of UAD Powered Plug-Ins instances you wish to compensate.

**When to use DelayComp**

UAD DelayComp should be used whenever unprocessed audio tracks are played alongside audio tracks that are assigned to a send/group/bus that is using a UAD plug-in(s). In this scenario, inserting a UAD DelayComp plug-in on the UNPROCESSED track(s) will automatically re-synchronize the audio.

**Virtual Instruments**

Cubase and Nuendo currently do not automatically compensate for latency on MIDI virtual instrument (VSTi) tracks. Therefore, UAD DelayComp should also be used on non-VSTi tracks when VSTi's are in use.

**Note:** Check out our *UAD DelayComp Examples on the UAD Powered Plug-Ins CD-ROM (or download them from our website) for "real-world" examples formatted for several popular host applications.*

**Plugs Parameter**

The DelayComp Plugs parameter value to be used on an unprocessed track or tracks is simply the number of UAD Powered Plug-Ins that are being used in sequence on the send, group, or bus.

For example, if three separate sends are used and each send has one instance of UAD plug-ins, the Delay Compensator Plugs value for the unprocessed tracks would be one. However, if one send/group/bus is used that has three instances of UAD Powered Plug-Ins stacked up, the Delay Compensator Plugs value for the dry tracks would be three.

**Note:** The Delay Compensator "Plugs" value matches the total of UAD Powered Plug-Ins used serially (stacked one above another in series), *NOT* the total number of UAD Powered Plug-Ins used.

**Samples parameter**

The Samples parameter shifts the audio with single-sample accuracy in either direction. It is provided mainly for compensation of the upsampled UAD plug-ins (see "[Compensating Upsampled Plug-Ins](#)" on page 95). However, it can be used anytime minute shifting of audio is desired. Audio can be shifted up to 128 samples in either direction.

The keyboard shortcuts PageUp/PageDown and Shift+Arrow automatically add shift the Samples value in 13-sample increments.

## Grouping Tracks Requiring DelayComp

The UAD DelayComp plug-in is generally used on track inserts. However, when many tracks require delay compensation, instead of placing individual Delay Compensator plug-ins on each track you may find it easier to send the output of each unprocessed tracks to a bus or group. Then simply put one UAD Delay Compensator on that bus or group.

## DelayComp Examples

**Important:** *Delay compensation is fully automatic and requires no user intervention when UAD Powered Plug-Ins are used in hosts that support full plug-in delay compensation. See “Host PDC Implementation” on page 88.*

### Insert

Situation: You have a song with bass, drums, and guitar. You want a room simulator on the guitar so you put an RS-1 on an insert of the guitar track. Result: All tracks are perfectly aligned.

Solution: None needed. Delay compensation on track inserts is handled automatically by most host applications.

### Send

Situation: You have a song with bass, drums, guitar, and 2 vocal tracks. You want a fantastic reverb on the vocals so you send both vocal tracks to the UAD RealVerb Pro via an effect send. Result: The RealVerb Pro effect return plays late in relation to the dry tracks.

Solution: Send the output of all the tracks (including the dry vocal tracks but NOT the RealVerb Pro return) to a different send/group/bus and put one UAD DelayComp with a Plugs value of 1 on this send/group/bus that contains the dry tracks. Keep the Sample value at zero.

### Group/Bus

Situation: You have a song with bass, drums, guitar, and 2 vocal tracks. You want a smoother vocal blend so you put both vocal tracks on a group/bus for compression with the infamous LA2A. Result: The vocal tracks play late in relation to the instrument tracks.

Solution: Send the output of the unprocessed instrument tracks (but not the vocal tracks or LA2A return) to a different group/bus and put one DelayComp with a Plugs value of 1 on this group/bus that contains the unprocessed tracks. Keep the Sample value at zero.

**Note:** *Check out our UAD DelayComp Examples on the UAD Powered Plug-Ins CD-ROM (or download them from our website) for “real-world” examples formatted for several popular host applications.*

## UAD Track Advance

### Overview

The previous discussions on delay compensation (see “[Latency & Delay Compensation](#)” on page 88) apply mainly when using only audio tracks. When MIDI tracks are played simultaneously alongside audio tracks, a different (but related) synchronization issue can arise.

Let’s say you have a MIDI track and an audio track with a UAD plug-in on the audio track insert. In this scenario, the host application will automatically compensate for latency and no use of the UAD DelayComp or UAD Track Advance is required.

However, if the audio track is sent to a send/group/bus and that send/group/bus has a UAD plug-in on it, the audio track will be delayed in relation to the MIDI track because the host does not compensate for latency automatically on groups/buses (unless full-path latency compensation is implemented in the host). If the MIDI track was an audio track, you would use the UAD DelayComp on it to compensate for the latency. But you can’t put a UAD DelayComp on a MIDI track, so what to do?

Enter the UAD Track Advance plug-in (TrackAdv for short). It operates just like the DelayComp plug-in, but backwards. Instead of delaying unprocessed tracks, it shifts them forward. It does this by reporting to the host application that a track has a UAD plug-in on it, so the host compensates for the latency. However, the track audio is not actually processed by the UAD so the net result is that the audio plays early.



Figure 22. The UAD Track Advance plug-in window

**Note:** *The Track Advance plug-in only works in hosts that support partial (track inserts only) automatic delay compensation.*

### When to use TrackAdv

UAD TrackAdv should be used whenever MIDI tracks are played alongside audio tracks that are assigned to a send/group/bus that is using UAD plug-in(s).

**Important:** *UAD TrackAdv should not be used in host applications that provide full PDC throughout the entire signal path. TrackAdv or DelayComp is not needed at all in such hosts. See “[Host PDC Implementation](#)” on page 88.*

## How to use TrackAdv

UAD TrackAdv is designed to be used on audio track inserts of tracks that are assigned to a send/group/bus that has one or more UAD plug-ins applied. By first advancing the audio with TrackAdv on the track insert then processing the same track on a send/group/bus that has a UAD plug-in, the “net latency result” is zero and the audio will be perfectly aligned with the MIDI tracks.

## Plugs parameter

The TrackAdv Plugs parameter value to be used on a track insert is simply the number of UAD plug-ins that are being used in sequence on the send, group, or bus that the track is assigned to.

For example, if three separate sends are used and each send return has one instance of UAD plug-ins, the TrackAdv plug-in value for the audio tracks insert would be one. However, if one send/group/bus is used that has three instances of UAD Powered Plug-Ins stacked up, the TrackAdv Plugs value for the tracks inserts would be three.

**Note:** The TrackAdv “Plugs” value on the track insert matches the total of UAD Powered Plug-Ins used serially (stacked one above another in series) on the send/group/bus that the track is assigned to, NOT the total number of UAD Powered Plug-Ins used.

## Samples parameter

The Samples parameter shifts the audio with single-sample accuracy in either direction. It is provided mainly for compensation of the upsampled UAD plug-ins (“Compensating Upsampled Plug-Ins” on page 95). However, it can be used anytime minute shifting of audio is desired. Audio can be shifted up to 128 samples in either direction.

**Note:** The keyboard shortcuts PageUp/PageDown and Shift+Arrow automatically add the 13-sample Pultec value for your convenience.

## TrackAdv Examples

### Insert

Situation: You have one track with MIDI and one track with audio. You put a UAD plug-in on the audio track. Result: All tracks are perfectly aligned.

Solution: None needed. Delay compensation on track inserts is handled automatically by most host applications.

### Send

Situation: You have a song with drums and guitar on audio tracks, and a MIDI bass line. You want a cohesive room reverb on the audio tracks so you send them to the UAD RealVerb Pro via an effect send. Result: The RealVerb Pro effect return plays late in relation to the MIDI track.

Solution: Put a TrackAdv plug-in on the track insert of the audio tracks with a Plugs value of 1. If you had an 1176LN and a RealVerb Pro on the send return, the TrackAdv Plugs value would be 2. Keep the Sample value at zero.

### **Group/Bus**

Situation: You have a song with 2 vocals on audio tracks, and a MIDI piano. You want a smoother vocal blend so you put both vocal tracks on a group/bus for compression with the infamous LA2A. Result: The vocal tracks play late in relation to the MIDI track.

Solution: Put a TrackAdv with a plug-in value of 1 on the track inserts of the vocal tracks. Keep the Sample value at zero.

Situation: You have a song with drums, guitar, and 2 separate vocals on audio tracks, and a MIDI bass line. You want a smoother vocal blend so you put both vocal tracks on a group/bus for compression with the 1176LN. Result: The vocal tracks play late in relation to the instrument tracks.

Solution: Put a TrackAdv with a plug-in value of 1 on the track inserts of the vocal tracks. Keep the Sample value at zero. Note that the DelayComp plug-in is not needed at all in this situation.

## **Compensating Upsampled Plug-Ins**

Some UAD plug-ins use an internal sample rate of 192kHz to achieve their sonic quality. This upsampling results in a larger latency than other UAD plug-ins. Therefore, they require more compensation to remain perfectly synchronized with other tracks.

When using the DelayComp or TrackAdv plug-in to manually compensate for an upsampled UAD plug-in, the latency value from [Table 7 on page 96](#) must be entered as the “Samples” value in addition to the appropriate “Plugs” value for each instance of the upsampled plug-in. Note that the compensation value to use depends on the session sample rate.

### **Upsampled Compensation Notes**

- Compensating for upsampled UAD plug-ins is not required if the host application supports full plug-in delay compensation throughout the signal path.
- Compensating for upsampled UAD plug-ins is not required when these plug-ins are used for program material on the output bus, where latency is not a consideration.
- If only one latency value is shown in [Table 7](#), the value applies to both UAD-1 and UAD-2. N/A means that sample rate is not supported.

- UAD Pultec-Pro only requires one compensation per instance. For example, if using both MEQ-5 and EQP-1A within a single Pultec-Pro, only one instance compensation is required.
- Since the maximum Samples value in one DelayComp instance is 128, more than one DelayComp instance will be required (in series) if the compensation value from [Table 7](#) exceeds 128.
- Latency compensation techniques for upsampled plug-ins apply to UAD Track Advance ([page 99](#)) as well.
- The latency in [Table 7](#) is also produced when LiveTrack mode ([page 76](#)) is used with upsampled plug-ins.
- Upsampled plug-in latency cannot be displayed in the “[Plug-In Latency Section](#)” on [page 59](#) due to technical limitations.

## Upsampling Values Table

[Table 7](#) lists the additional latency produced by upsampled UAD plug-ins. See the “[Compensating Upsampled Plug-Ins](#)” on [page 95](#) for details.

Table 7. Upsampled UAD plug-ins with additional latencies

Upsampled Plug-In	Sample Rate (kHz)					
	44.1	48	88.2	96	176.4	192
Pultec EQ/Pultec-Pro	UAD-1: 13 UAD-2: 31	UAD-1: 13 UAD-2: 31	13	13	0	0
Precision Limiter	64	69	129	140	259	281
Neve 33609	UAD-1: 67 UAD-2: 55	UAD-1: 67 UAD-2: 55	UAD-1: 67 UAD-2: 55	UAD-1: 67 UAD-2: 55	UAD-1: 42 UAD-2: 88	UAD-1: 42 UAD-2: 88
Precision Maximizer	67	67	67	67	42	42
Precision EQ Helios Type 69 Neve 1073 Neve 1081	31	31	13	13	0	0
Precision Multiband	15360	16,896	30,720	33,792	UAD-1: N/A UAD-2: 61,440	UAD-1: N/A UAD-2: 66,048



## Upsampled Compensation Examples

### Group/Bus Example

Situation: You have a session at 44.1 kHz with bass, drums, guitar, and 2 vocal tracks. You want a fat, warm vocal blend so you put both vocal tracks on a group/bus and apply one instance of UAD Helios 69 to the vocal bus. Result: The vocal tracks play late in relation to the instrument tracks.

- Solution: Send the output of the unprocessed instrument tracks (but not the vocal tracks or the Pultec return) to a different group/bus, and put one DelayComp with a Plugs value of 1 and a Samples value of 31 (the 44.1 kHz value for Helios 69 from [Table 7](#)) on this group/bus that contains the dry non-vocal tracks. If you put 2 Helios 69's stacked in series on the vocal bus, the unprocessed bus DelayComp plug-in value would be 2, and the Samples value would be 62.

### Compensating Precision Multiband

The Precision Multiband (PMB) has a significantly larger latency than other upsampled plug-ins because of the linear reconstruction of the filter bank.

Because manually compensating for Precision Multiband latency in hosts that don't support full plug-in delay compensation can be complicated, to avoid timing errors in these hosts we generally recommend using Precision Multiband only on outputs, so no manual compensation is required.

### The PMB Formula

To manually compensate for Precision Multiband latency when used on groups/buses in hosts that don't support full PDC, use the following formula:

$$L1 \div L2 = \text{UAD DelayComp(s) value}$$

Where "L1" is the Precision Multiband latency from [Table 7](#), and "L2" is the latency from the UAD Control Panel System Information window (note that at least one UAD plug-in must be running in the host to obtain a valid value).

This formula will arrive at the DelayComp Plugs parameter value (whole number result), or Plugs plus Samples value (non-whole number result) needed for compensation. Since the maximum Plugs/Samples value in one DelayComp instance is 10/128, more than one DelayComp instance will be required (in series) if the Plugs/Samples value exceeds 10/128, which can happen at lower buffer sizes and/or higher sample rates.

## PMB Group/Bus Examples

Situation: You have a session with bass, drums, piano, and 2 vocal tracks. The session is running at 44.1 kHz and your I/O buffer is set to 512 samples. You want to tighten up the rhythm section so you put the bass, drum, and piano tracks on a group/bus and apply one instance of Precision Multiband to the rhythm section group/bus. Result: The rhythm section plays late in relation to the vocal tracks.

Solution: Send the output of the vocal tracks (but not the rhythm tracks or the Precision Multiband return) to a different group/bus. Then enter the numbers into the formula:

$$15,360 \div 1,024 = 15$$

Now put one DelayComp with a Plugs value of 10, and another DelayComp with a Plugs value of 5 on the group/bus that contains the vocal tracks. The latency of both groups/buses is now the same, so the playback timing is correctly aligned.

Here's another example with the same track setup, but with a session sample rate of 48kHz and an I/O buffer size of 1024 samples. Use the formula to arrive:

$$16,896 \div 2048 = 8.25$$

When a non-whole number results from the formula, the Samples parameter must be used in addition to the Plugs parameter. The Samples value to use is the fraction (in this case 0.25) times the UAD latency (from the UAD System Info window, in this case 2048). Therefore in this example, the total Samples value is 512. To finish the example:

Insert one DelayComp with a Plugs value of 8 and a Samples value of 128, and three more DelayComps with a Plugs value of 0 and a Samples value of 128 each on the group/bus that contains the vocal tracks. The four Samples values sum to 512 samples, which is 0.25 of one Plugs value ( $2048 \times .25 = 512$ ). The latency of both groups/buses is now the same, so the playback timing is correctly aligned.

**Note:** *You can keep it simple: Use the Precision Multiband only on outputs (as its design was intended), or only in hosts that have full plug-in delay compensation!*

## Live Processing

The previous discussions of delay compensation applies primarily to playback and mixing of existing tracks. During recording (tracking), the primary concern usually centers around getting the absolute lowest possible latency out of your hardware and software combination. The lower the latency is, the closer you can get to a realtime, “ears match the fingers” performance situation in the digital environment where some latency is unavoidable.

Realtime latency is displayed in the System Information panel ([page 58](#)) within the UAD Meter & Control Panel application.

**UAD-1** Minimizing realtime latency is simply a matter of setting the audio I/O interface device driver buffer setting as low as possible before system overloads or diminished audio quality (such as distortion) occurs. The manufacturer of the sound output device in use may offer additional tips for optimizing latency on systems that use their hardware.

**UAD-2** The UAD-2 card has an advanced buffering architecture that delivers near-zero latency performance when tracking by using LiveTrack Mode, which bypasses the audio interface device driver buffers altogether. See “[LiveTrack Mode](#)” on [page 76](#) for details.

## CHAPTER 10

# UAD-Xpander & UAD-Xtenda

### Overview

The UAD-Xpander is the world's first ExpressCard audio DSP expansion system for Mac OS X and Windows Vista notebook computers. Using an ultra-fast ExpressCard 34 connection (2.5Gbps differential serial link), ExpressCard is the new expansion standard in the latest notebooks, such as the MacBook Pro. The UAD-Xpander has identical DSP power as the best-selling UAD-1 & UAD-1e PCI/PCIe series of desktop products, and is fully compatible with all Powered Plug-Ins. Like its desktop siblings, the UAD-Xpander can mix sessions from 44.1khz to 192k. The UAD-Xpander conveniently leaves slower, USB & Firewire connections free for dongles, Audio I/O, and hard drives, while it operates at full PCI Express bandwidth.

The UAD-Xpander comes in three bundles: Xpress, Xpert, and Xtreme. Like UA's existing UAD-1e Express & Expert PAK's, the difference is only in the bundled UAD vouchers. Each UAD-Xpander comes free with UA's base set of 14 Mix Essential plug-ins, plus the UAD-Xpander Xpress includes a \$500 voucher, and the UAD-Xpander Xpert a \$1000 voucher which allows complete flexibility in choosing from UA's premium collection of mixing and mastering plug-ins available 24/7 at [my.uaudio.com](http://my.uaudio.com). The UAD-Xpander Xtreme includes every Powered Plug-In up to and including those available in UAD software version 4.5.

### Features

- Noiseless, Fanless, Alumi-cool chassis design
- Ultra-fast (2.5Gbps) ExpressCard 34 interface
- 44.1-192k DSP Audio Accelerator for notebook computers
- Same potent DSP power as UAD-1 & UAD-1e
- Optional UAD-Xtenda Kit: 3m cable & PCIe desktop ExpressCard adapter

### Xpander Documentation

The UAD-Xpander is a hardware system designed for use with UAD Powered Plug-ins, which is the companion software package that includes the drivers, plug-ins, and software documentation.

In this chapter you will find instructions specific to the UAD–Xpander hardware system only. Further information and instructions for the hardware and software are also available. To get the most from your UAD–Xpander, please review the following additional information:

### **Critical Information**

Important user information is presented on a printed document within the UAD–Xpander retail package. It provides last-minute details not included in the manual. Please review this information carefully.

### **Technical Updates**

Updated UAD technical information is regularly posted to the UA website. Please visit the UAD support pages for the latest bulletins:

- <http://www.uaudio.com/support/software/UAD>

### **Xpander Videos**

The UAD DSP Family Quickstart Guide DVD included in the Xpander retail package contains a UAD–Xpander video which provides a convenient overview of the UAD–Xpander product and brief instructions on how to connect and use the UAD–Xpander. Detailed instructions for registering your UAD–Xpander, purchasing plug-ins, and authorizing your UAD–Xpander are also included. This QuickStart Guide DVD is different from the one in the UAD-2 retail package.

### **Xpander System Requirements**

To use the UAD–Xpander, your system must meet the minimum system requirements for UAD Powered Plug-Ins (see “[System Requirements](#)” on page 21) in addition to the Xpander-specific requirements.

#### **UAD–Xpander requires the following hardware and software:**

- UAD Powered Plug-ins software v4.7.1 or higher (included)
- Available ExpressCard/34 or ExpressCard/54 expansion slot
- Available PCI Express (PCIe) slot for each optional UAD–Xtenda card
- (Win) Windows notebooks are supported under Windows Vista only

## Xpander Installation

- Install Software First** Software installation for UAD-Xpander is the exact same procedure as those for UAD cards. Please refer to “[UAD Software Installation](#)” on page 23 for detailed procedures.
- Software Updates** The CD-ROM in the retail package may not contain the latest UAD software. The version is displayed on the CD. Check our website for software updates:
- <http://www.uaudio.com/support/software/UAD/downloads.html>
- If the UAD software is already installed, the UAD Meter & Control Panel has a convenient button that links to the updates page (“[Check for Updates](#)” on page 58).
- Package Contents** The UAD-Xpander package should contain the following items:
- UAD-Xpander Carry Case
  - UAD-Xpander Chassis
  - UAD ExpressCard/34 (ExpressCard/54 compatible)
  - 1-meter UAD Link Cable
  - AC Power Supply Unit with international adapters
  - UAD DSP Family Quickstart Guide DVD
  - UAD Powered Plug-Ins software CD-ROM
- Install Location** When selecting a location to position the UAD-Xpander during installation and use, consider these points:
- The UAD-Xpander should be positioned on a secure, stable surface and not moved during operation. This will help prevent the disruption of signals from cables and/or connectors if they are accidentally bumped (or worse).
  - For proper ventilation to prevent overheating, place the UAD-Xpander on a hard, flat surface and do not cover the unit. Allow air to circulate underneath the chassis.
  - High levels of radio-frequency radiation could interfere with proper operation. If possible, avoid placement near unshielded monitors, radio transmitters, and similar equipment.

**Note:** Do not bend sharp angles into or otherwise kink the UAD link cable. The cable has a ferrite core and multiple conductors that could be damaged by improper handling.

## Xpander Connections

This section describes how to set up the UAD–Xpander and connect it to the computer. Hardware installation is the same for all platforms.

### Power Down!

Before connecting the UAD–Xpander to your computer, make sure both systems are completely powered down.

**Important:** Because the Xpander drivers are loaded during startup, merely putting the system to hibernate or sleep is insufficient.

#### To connect the UAD–Xpander components:

1. Power down the host computer, and make sure the UAD–Xpander power switch is in the Off position.
2. Connect one end of the UAD Link cable to the UAD ExpressCard (the connector is keyed so it cannot be incorrectly inserted).
3. Connect the other end of the UAD Link cable to the UAD–Xpander chassis (the connector is keyed so it cannot be incorrectly inserted).
4. Select a suitable location for the UAD–Xpander chassis (see “[Install Location](#)” on page 102).
5. Insert the UAD ExpressCard fully into the ExpressCard/34 or ExpressCard/54 expansion slot on the host computer until it is firmly seated.
6. Connect the AC end of the power supply unit to the AC wall socket. If you need a different AC connector for your country, remove the attached connector and replace it with one of the supplied alternate connectors.
7. Connect the DC end of the power supply to the UAD–Xpander chassis. You can loop the power cable through the hook on the chassis to reduce cable strain and the chance of accidental disconnection.

#### UAD–Xpander connections are now complete.

If the UAD Powered Plug-Ins software is already installed (“[UAD Software Installation](#)” on page 23), you are now ready to use the UAD–Xpander. Refer to “[Using UAD–Xpander](#)” on page 105.

## UAD–Xtenda

The UAD–Xtenda is an optional package that enables the UAD–Xpander to be used in a desktop computer that has PCIe expansion slots. The UAD–Xpander/Xtenda system provides a convenient way to switch the same UAD–Xpander unit between desktop and notebook computers.

### Multicard Setup

If a computer system has both PCI/PCI-X and/or PCIe slots, the UAD–1, UAD–1e, and UAD–Xpander via UAD–Xtenda (or any combination thereof) can all be installed and used simultaneously as a multicard system (four cards maximum). The UAD drivers and plug-ins are the same for the UAD–1, UAD–1e, and UAD–Xpander. See [Chapter 5, “Using Multiple UAD Cards”](#) for detailed information.

### Xtenda Package Contents

The UAD–Xtenda package should contain the following items:

- UAD–Xtenda PCIe expansion card
- UAD Link Cable

### Xtenda Installation

Installing the UAD–Xtenda card uses the exact same procedures as UAD card installation. Please see [“UAD Hardware Installation” on page 25](#) for step-by-step procedures.

Connect the UAD–Xpander to the UAD–Xtenda. [“Xpander Connections” on page 103](#)

If the UAD Powered Plug-Ins software is already installed (see [page 23](#)), you are now ready to use the UAD–Xpander using the instructions in the next section.

## Xpander Operation

After UAD Powered Plug-Ins software v4.7.1 (or higher) is installed and the UAD–Xpander is connected to the notebook computer or desktop computer via UAD–Xtenda, the system is ready to be powered up and used.

**Note:** All UAD–Xpander instructions apply regardless of whether the unit is attached to a notebook computer or a desktop computer via UAD–Xtenda.

### Startup Sequence

For optimum results, specific steps must be followed when starting the UAD–Xpander and host computer system. Following this sequence ensures the Xpander electrical and UAD driver requirements are properly met.



### UAD–Xpander Pre-Flight Check

1. Ensure UAD Powered Plug-Ins v4.7.1 (or higher) is already installed (see “UAD Software Installation” on page 23).
2. Ensure both the host computer and UAD–Xpander are powered off.
3. Ensure the UAD–Xpander is properly connected (see “Xpander Connections” on page 103).

### UAD–Xpander Startup Sequence

1. Turn on the UAD–Xpander power switch on the rear of the unit. The UA logo glows red, indicating UAD–Xpander power is on but is not electrically connected to the computer.
2. Boot the computer. The UA logo glows blue, indicating an electrical connection has been established with the computer.
3. – (Windows) The UAD drivers are installed automatically by the New Hardware Wizard during the first boot following initial software installation.  
– (Mac) The UAD drivers are loaded during boot.
4. You can confirm UAD driver communication is established by using the UAD Performance Meter. See “Using the UAD Performance Meter to Check Installation” in the QuickStart.pdf.

**The UAD–Xpander startup sequence is complete.**

### Using UAD–Xpander

After the UAD–Xpander is installed and powered up properly with the computer system (see “Startup Sequence” on page 104), the UAD Powered Plug-Ins software is ready to be used. Refer to other chapters in this manual for software operating instructions.

**Note:** All UAD–Xpander operations (except for hardware setup and startup sequence) are identical to the UAD-1/UAD-1e/UAD-2 cards.

### Power Indicator

When power is applied to the UAD–Xpander via the rear switch, the UA logo on the front panel glows. The color of the logo indicates the power state

- When UAD–Xpander power is on but there is no electrical connection to the computer (such as when the computer is off), the UA logo glows red.

- When power is on and there is an electrical connection to the computer, the UA logo glows blue (Figure 23).



Figure 23. UAD-Xpander Power Indicator

**Note:** The Power Indicator displays the state of the electrical connections only. It does not indicate when UAD driver communication is established (use the UAD Meter to check driver communication status).

### Hot Swapping

Hot swapping is not supported. Hot swapping refers to the ability to disconnect the UAD ExpressCard while the notebook computer is active or sleeping, and reconnect it at a later time without rebooting.

**Note:** For proper functionality, you must reboot the computer with the Xpander connected every time the UAD ExpressCard has been removed.

### Disconnect

The UAD-Xpander can be disconnected when the notebook computer is active or sleeping only if these two conditions are met:

1. No host applications (including UAD Meter & Control Panel) are running.
2. The ExpressCard is properly powered down by the operating system.

**To disconnect the UAD-Xpander while the notebook is active:**

1. Quit all UAD host applications, including the UAD Performance Meter. This ensures that all UAD Powered Plug-Ins are inactive.
2. Power down the ExpressCard, using the following method as defined by the operating system:
  - (Windows) In the Windows Task Bar, click the Safely Remove Hardware icon, and select "Safely remove Universal Audio UAD-1 DSP card" (Figure 24 on page 107).
  - (Macintosh) In the Menu Bar, click the ExpressCard status menu icon, and select "Power off Card" (Figure 25 on page 107)

3. Turn off the power switch on the back of the UAD-Xpander.
4. Remove the UAD ExpressCard from the expansion slot.

**UAD-Xpander disconnection is complete.**

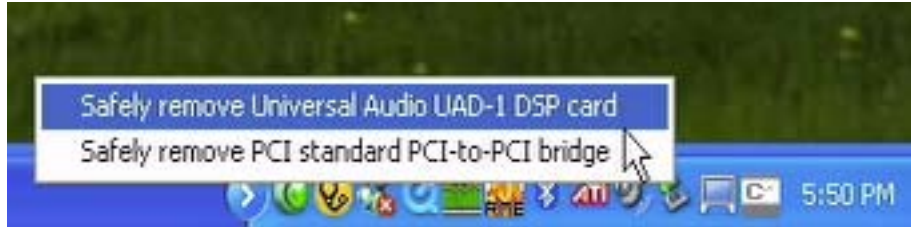

Figure 24. ExpressCard Power Down (Windows)



Figure 25. ExpressCard Power Down (Macintosh)

## Reconnect

Once the UAD-Xpander has been disconnected for any reason, the computer must be rebooted with the UAD-Xpander connected. Follow the ["Startup Sequence"](#) on page 104 for reconnection instructions.

## System Sleep

### Windows



System Sleep (hibernate) is not supported when using UAD-Xpander under Windows. Sleep should be disabled while the UAD-Xpander is connected.

#### To disable Sleep in Windows:

1. In the Control Panel>Performance and Maintenance>Power Options>Power Scheme panel, set the Power Scheme to "Always On"
2. To disable Sleep in when notebook lid is closed: In Control Panel>Performance and Maintenance>Power Options: Click the "Change when the computer sleeps" option on the left side of the screen, then select "Never"

## Macintosh



System Sleep is supported under Mac OS X. If the machine is put to sleep with the transport running, the UAD plug-ins will typically be disabled several seconds before audio stops. Therefore, a change in the audio may be noticed. Similarly, when the system is awakened, it may take several seconds for the UAD plug-ins to be reinitialized.

### Important Xpander Notes

- Do not remove the UAD Link Cable or the UAD ExpressCard, or power down the UAD-Xpander while the Xpander is connected to the computer. Doing so could cause the computer to crash, unless the ExpressCard is properly powered down (see [“Disconnect” on page 106](#)).
- Disable system Sleep while the UAD-Xpander is connected under Windows (see [“System Sleep” on page 107](#)).
- The ExpressCard slot on notebook computers is non-latching, so it is possible to accidentally pull the card out.
- Select a suitable location for the unit. See [“Install Location” on page 102](#).
- Do not bend sharp angles into or otherwise kink the UAD link cable. The cable has a ferrite core and multiple conductors that could be damaged by improper handling.
- The UAD ExpressCard/34 can be used in an ExpressCard/54 slot.
- The UAD-Xpander contains a UAD-1e card that looks similar to the UAD-1e model for desktop computers. However, the cards are not the same.

**Important:** Do not attempt to install a UAD-Xpander card into a computer slot, or put a UAD-1e into the Xpander chassis. Doing so will damage the cards and/or the computer logic board.

## CHAPTER 11

# LA-2A and 1176LN

### Overview

The LA-2A and 1176LN compressor/limiters long ago achieved classic status. They're a given in almost any studio in the world - relied upon daily by engineers whose styles range from rock to rap, classical to country and everything in between. With so many newer products on the market to choose from, it's worth looking at the reasons why these classics remain a necessary part of any professional studio's outboard equipment collection.

The basic concept of a compressor/limiter, is of course, relatively simple. It's a device in which the gain of a circuit is automatically adjusted using a predetermined ratio that acts in response to the input signal level. A compressor/limiter "rides gain" like a recording engineer does by hand with the fader of a console: it keeps the volume up during softer sections and brings it down when the signal gets louder. The dynamic processing that occurs at ratios below 10 or 12 to one is generally referred to as compression; above that it's known as limiting.

Modern day compressors offer a great degree of programmability and flexibility; older devices such as the 1176LN and the LA-2A are more straightforward in their design. Perhaps it is this fact that has contributed to their appealing sound and the longevity of their popularity.

### Compressor Basics

Before discussing the LA-2A and 1176LN plug-ins, this section will cover some compressor basics. A *compressor* automatically adjusts the gain of a signal by a predetermined ratio. In a sense, a compressor "rides" gain—much like a recording engineer does (by hand) with a fader—keeping the volume up during softer sections and bringing it down when the signal gets louder.

Figure 26 depicts the input and output characteristics of a compressor and perfect amplifier. When operated within its specified range, an amplifier provides a constant amount of gain regardless of the input signal level. In Figure 26, the signal level of a perfect amplifier is represented with a constant output gain of 10 dB. In this example, a signal with an input level of  $-30$  dB results in an output level of  $-20$  dB, which is an increase of 10 dB. Similarly, an input level of 0 dB results in an output level of 10 dB (the gain stays fixed at 10 dB regardless of the input level).

In contrast to an amplifier, whose function is to present a constant gain, a compressor varies its gain in response to the level of the input signal. Large input signals result in less gain, thus reducing or *compressing* the dynamic range of the signal. In Figure 26, a compressed signal with an input level of  $-30$  dB results in an output level of  $-20$  dB, indicating a gain of 10 dB. However, with input levels of  $-20$  dB and  $-10$  dB, the compressor exhibits gains of 5 dB and 0 dB (respectively), thereby illustrating that the gain decreases as the input signal increases. This increase in output level by 5 dB for every 10 dB is defined as a compression ratio of 2:1 (reduced from 10:5).

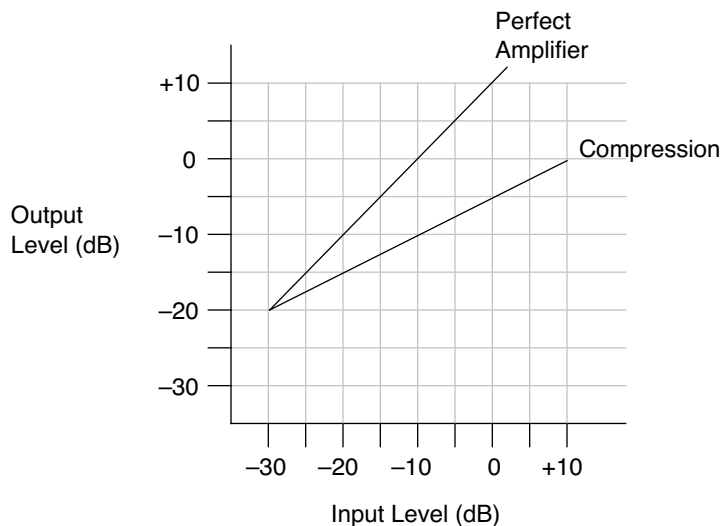

Figure 26. Input and output characteristics of a compressor and perfect amplifier

The amount of compression, or gain reduction, typically expressed in decibels (dB), is defined as the amount by which the signal level is reduced by the compressor. Graphically, this can be represented (see Figure 27) by the difference in output levels between the original signal (without compression) and the compressed signal. The LA-2A and 1176LN display this value when their VU Meters are set to Gain Reduction.

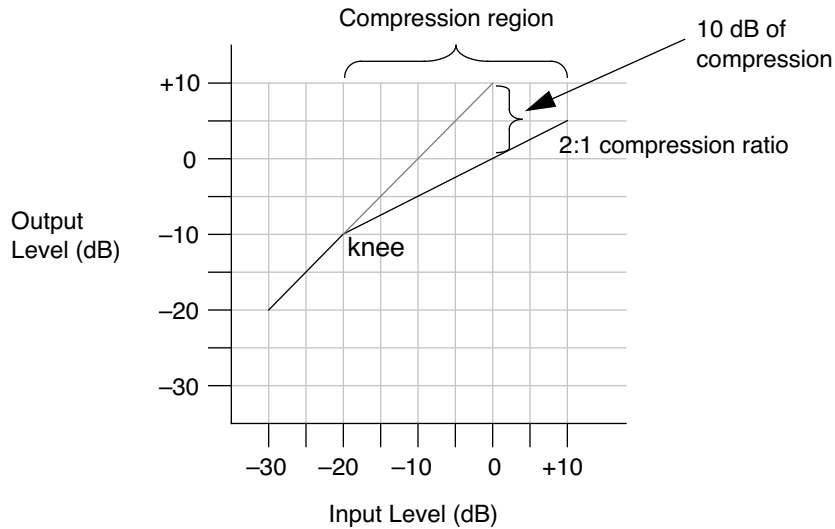

Figure 27. Input and output curve of compressor with 2:1 ratio and -20 dB threshold

As mentioned previously, the compression ratio is defined as the ratio of the increase of the level of the input signal to the increase in the level of the output signal. In [Figure 27](#), the input level is increased by 10 dB while the output level increases 5 dB. This is a compression ratio of 2:1. Lower compression ratios such as 2:1 result in mild compression. A compression ratio of 1:1 yields no compression.

**Note:** Compression ratios above 10:1 are commonly referred to as “limiting” or “peak-limiting,” where amplitude peaks are reduced.

Compressors often let you set a threshold, the point at which gain reduction starts to take place. When the level of an audio signal is below this threshold there is no gain reduction. As the level of the signal increases above the threshold level, gain reduction and compression occurs. The point at which a signal transitions into compression is commonly referred to as the *knee*. In practical compressors, this transition is more gentle than what is depicted in [Figure 27](#).

Most modern compressors provide a control that adjusts the threshold directly. In the case of the LA-2A, the Peak Reduction control adjusts both the threshold and the amount of gain reduction. Similarly, the 1176LN uses its Input control to adjust the threshold and amount of gain reduction.

## Teletronix LA-2A Leveling Amplifier

### Background

Audio professionals passionate about their compressors revere the LA-2A. The original was immediately acknowledged for its natural compression characteristics. A unique electro-optical attenuator system allows instantaneous gain reduction with no increase in harmonic distortion – an accomplishment at the time, still appreciated today.

The LA-2A is known for adding warmth (such as for vocals, guitar, or synths) and fatness (such as for drums or bass) to signals.

### LA-2A Signal Flow

A functional block diagram of the LA-2A Leveling Amplifier is provided in [Figure 28](#). The input transformer provides isolation and impedance matching. After this the signal is fed into both the side-chain circuit and the gain reduction circuit. The side-chain is comprised of a voltage amplifier, a pre-emphasis filter, and a driver stage that provides the voltage necessary to drive the electro-luminescent panel. This signal controls the gain of the compressor. After the gain reduction circuit, the signal is sent through an Output Gain control and a two-stage output amplifier, followed by the output transformer.

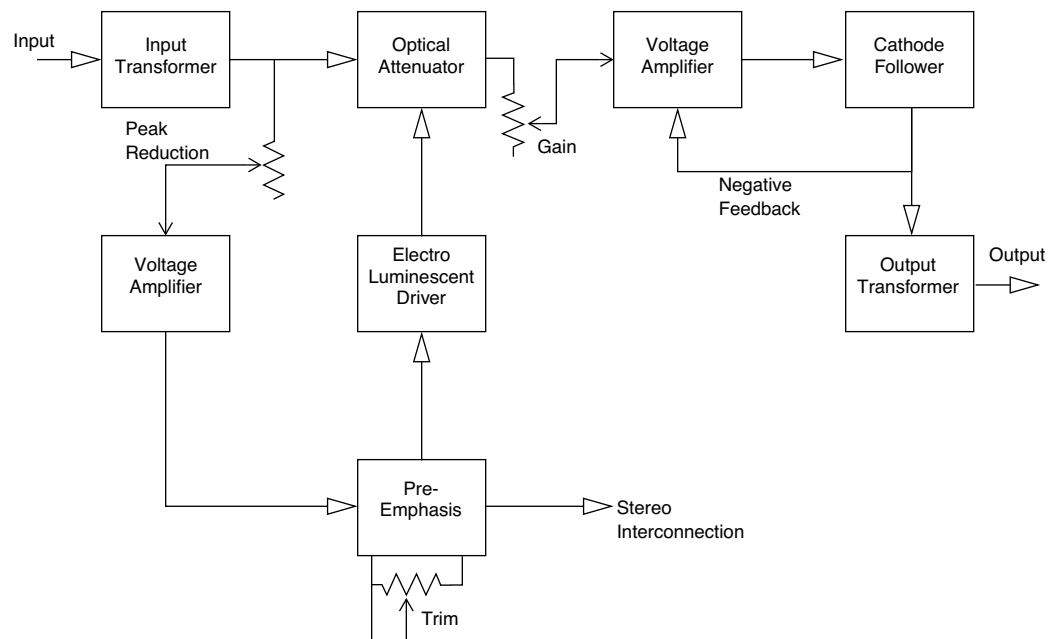

Figure 28. LA-2A signal flow



## LA-2A Controls



Figure 29. The LA-2A plug-in window.

- Limit/Compress** Changes the characteristics of the compressor I/O curve. When set to Compress, the curve is more gentle, and presents a low compression ratio. When set to Limit, a higher compression ratio is used.
- Gain** Adjusts the output level (by up to 40 dB). Make sure to adjust the Gain control *after* the desired amount of compression is achieved with the Peak Reduction control. The Gain control does not affect the amount of compression.
- Peak Reduction** Adjusts the amount of gain reduction, as well as the relative threshold. A Peak Reduction value of 0 yields no compression. Rotate this control clockwise until the desired amount of compression is achieved (to monitor the Peak Reduction, set the VU Meter to Gain Reduction). The Peak Reduction should be adjusted independently of the Gain control.
- Meter** This knob (in the upper right) sets the mode of the VU Meter. When set to Gain Reduction, the VU Meter indicates the Gain Reduction level in dB. When set to +10 or +4, the VU Meter indicates the output level in dB.
- On/Power Switch** Determines whether the LA-2A plug-in is active. When the Power switch is in the Off position, the plug-in is disabled and UAD DSP usage is reduced.
- Stereo Operation** Phase-coherent stereo imaging is maintained when the LA-2A plug-in is used on a stereo signal.

## 1176LN Solid-State Limiting Amplifier

The 1176LN is known for bringing out the presence and color of audio signals, adding brightness and clarity to vocals, and “bite” to drums and guitar.

### 1176LN Signal Flow

A functional block diagram of the 1176LN Limiting Amplifier is provided in [Figure 30](#). Signal limiting and compression is performed by the Gain Reduction section. Before the signal is applied to the Gain Reduction section, the audio signal is attenuated by the Input stage. The amount of attenuation is controlled by the input control potentiometer. The amount of gain reduction as well as the compressor Attack and Release times are controlled by Gain Reduction Control circuit. After Gain Reduction a pre-amp is used to increase the signal level. The Output Control potentiometer is then used to control the amount of drive that is applied to the output amplifier. The 1176LN is a feedback style compressor since the signal level is sensed after the gain reduction is applied to the signal.

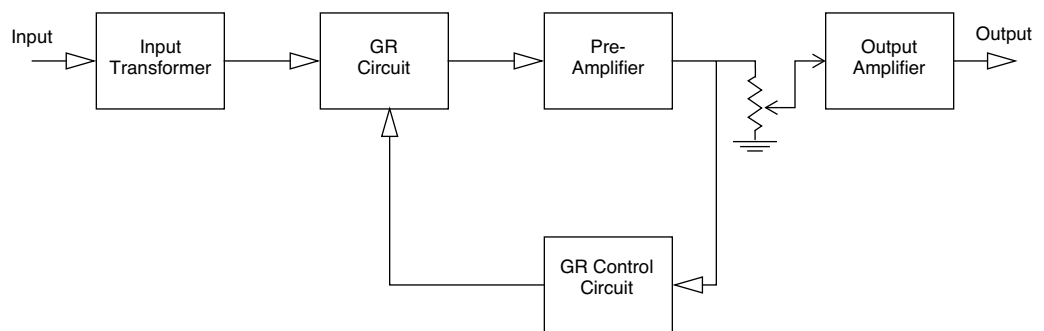

Figure 30. 1176LN signal flow

## 1176LN Controls

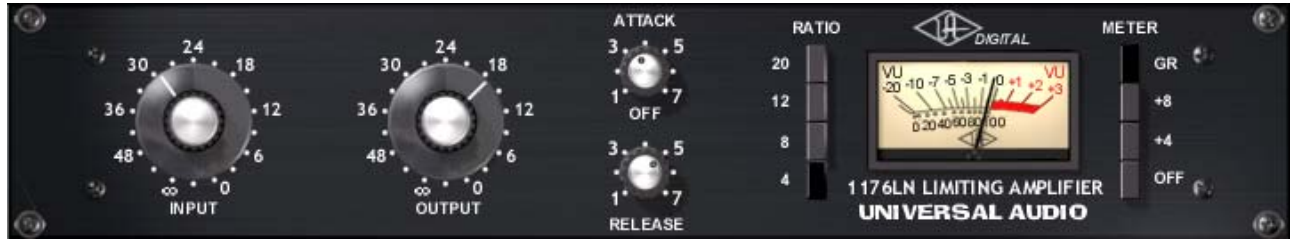

Figure 31. The 1176LN plug-in window

- Input** Adjusts the amount of gain reduction as well as the relative threshold. An Input value of  $\infty$  (turned fully counterclockwise) yields no compression (and no signal level). Rotate this control clockwise to increase the amount of compression.
- Output** Adjusts the output level (by up to 45 dB). Make sure to adjust the Output control *after* the desired amount of compression is achieved with the Input and Attack controls. To monitor the Output level, set the VU Meter to +8 or +4. The Output control does not affect the amount of compression.
- Attack** Sets the amount of time (from 20–800 microseconds) that must elapse once the input signal reaches the Threshold level before compression is applied. Faster attack times are achieved by rotating the Attack control clockwise. The faster the Attack, the more rapidly compression is applied to signals above the threshold.
- Release** Sets the amount of time (from 50–1100 msec.) it takes for compression to cease once the input signal drops below the threshold level. Faster release times are achieved by rotating the Release control clockwise. Slower release times can smooth the transition that occurs when the signal dips below the threshold, especially useful for material with frequent peaks. However, if you set too large of a Release time, compression for sections of audio with loud signals may extend to lengthy sections of audio with lower signals.
- Ratio** These four pushbutton switches (to the left of the VU Meter) determine the compression ratio. Ratios of 20:1, 12:1, 8:1, and 4:1 are provided. The 20:1 and 12:1 settings are typically used when peak-limiting is desired, while the 4:1 and 8:1 settings are used for general dynamic range compression.

**All Buttons mode** Just like the hardware version of the 1176LN, it is possible to depress all the Ratio buttons simultaneously, a well-known studio trick.

In this mode, the ratio is around 12:1, and the release happens faster, and the shape of the release curve changes. With lower amounts of compression, the attack is delayed slightly, as there is a slight lag before the attack attenuated the signal. That attack value remains at whatever the value is on the Attack control.

**To enter All Button Mode**

Shift-click any of the Ratio buttons. All of the buttons will appear depressed.

**To exit All Button Mode**

Click any Ratio button without the shift key modifier.

**Meter** These four pushbutton switches (to the right of the VU Meter) determine the mode of the VU Meter, and whether the plug-in is enabled. When set to GR, the VU Meter indicates the Gain Reduction level in dB. When set to +8 or +4, the VU Meter indicates the output level in dB; when set to +4, a meter reading of 0 corresponds to an output level of +4 dB.

In gain reduction mode with all buttons depressed, the VU meter will appear to behave strangely. This is normal behavior in the hardware 1176LN, and is faithfully recreated in the plug-in.

When the Meter Off switch is selected, the 1176LN plug-in is disabled and UAD DSP usage is reduced.

**Grit** One trick you can do with the 1176 is turning the attack and release up all the way to their fastest setting. This has the audible effect of adding distortion to the audio source, and is especially pronounced in all-buttons mode. What happens here is the attack and release are happening so fast that minute level fluctuations sound like distortion. It can add a very useful, gritty compression effect.

This effect is useful on bass, where you might need compression and distortion at the same time, and the 1176 can provide both in a unique way. This trick also sounds great on screaming lead vocals. And yes, the hardware does this too!

**Stereo Operation** Phase-coherent stereo imaging is maintained when the 1176LN plug-in is used on a stereo signal.

## 1176SE “Special Edition”



Figure 32. The 1176SE plug-in window

### Overview

The 1176SE is derived from the 1176LN. Its algorithm has been revised in order to provide sonic characteristics similar to the 1176LN but with significantly less DSP usage. It is provided to allow “1176LN-like sound” when DSP resources are limited.

The 1176SE behavior is practically identical to the 1176LN. Its sound is nearly identical too, but certain compromises had to be made in order to squeeze the extra DSP performance that the 1176SE provides. At nominal settings the sonic difference is negligible. At extreme (cranked) settings, nobody with “golden ears” will say it sounds exactly like the 1176LN, but it still sounds great and is very usable in most situations.

### 1176SE Controls

The 1176SE controls are exactly the same as the 1176LN. Please refer to the the 1176LN section for 1176SE control descriptions (see [“1176LN Controls” on page 115.](#)).

## CHAPTER 12-

# LA-3A Compressor

### Overview

The original Teletronix LA-3A Audio Leveler made its debut at the 1969 New York AES show. Marking a departure from the tube design of the LA-2A Leveling Amplifier, the solid-state LA-3A offered a new sound in optical gain reduction, with faster attack and release characteristics that were noticeably different from its predecessor. Immediately embraced as a studio workhorse, the LA-3A is still widely used today. Engineers and producers the world over favor the LA-3A for its unique compression characteristics and sonic signature. Modeled from a unit in UA's vintage collection, our digital emulation of the LA-3A faithfully captures the hardware's sound, working magic on vocals, guitars and drums.

### LA-3A Screenshot



Figure 33. The LA-3A plug-in window

## LA-3A Controls

- Background** For detailed information about compressors, see [“Compressor Basics”](#) on page 109.
- Comp/Lim** This switch changes the characteristics of the compressor I/O curve. When set to Compress, the curve is more gentle, and presents a low compression ratio. When set to Limit, a higher compression ratio is used.
- Gain** The Gain knob adjusts the output level (by up to 50 dB). Make sure to adjust the Gain control *after* the desired amount of compression is achieved with the Peak Reduction control. The Gain control does not affect the amount of compression.
- Peak Reduction** This control adjusts the amount of gain reduction, as well as the relative threshold. A Peak Reduction value of 0 yields no compression. Rotate this control clockwise until the desired amount of compression is achieved (to monitor the Peak Reduction, set the VU Meter to Gain Reduction). The Peak Reduction should be adjusted independently of the Gain control.
- Meter** This switch sets the mode of the VU Meter and also disables the plug-in. When set to Gain Reduction, the VU Meter indicates the Gain Reduction level in dB. When set to output, the VU Meter represents the output level (the output meter is not calibrated).
- When in the Off position, the plug-in is disabled and UAD DSP usage is reduced.
- Stereo Operation** Phase-coherent stereo imaging is maintained when the LA-3A plug-in is used on a stereo signal.

## CHAPTER 13

# Fairchild 670

### Overview

In the annals of compressor history, the products produced by Fairchild are some of the best built and most highly prized on the vintage market. The most famous Fairchild products produced were the 660 and 670 compressor/limiters, which are famous for their fantastic sound quality.

The stereo Fairchild 670 is probably the “Holy Grail” of compressors in studio gear esoterica, not only because of its price (known to fetch \$30,000 and beyond on the vintage market), but also its extreme rareness and the difficulties in maintaining such a unit. With its 14 transformers, 20 vacuum tubes, 6 rack-space encompassing girth and weighing in at 65 pounds, the Fairchild 670 is truly the heavyweight champion of compression.

Originating from the early 1950’s, the design of the 670 uses a single push-pull stage of amplification with an extremely high control voltage. The Fairchild 670 is a variable-mu tube limiter. Variable-mu limiters are unique in that they use tubes for gain reduction, and not just as amplifiers. The audio path is quite simple, and compression happens directly in the audio path, rather than sending out to a separate compression circuit.

The unit can be used as a limiter or compressor, depending upon personal taste and program material. It can go from a 2:1 ratio as a compressor to a peak limiter with a 30:1 ratio. The unit can also be adjusted to operate anywhere between these two extremes using the Threshold and DC Bias controls.

The UAD Fairchild was created by meticulously modeling (down to the component level as usual) a carefully selected hardware unit. Our “golden unit” was the Fairchild 670 (SN #505) at Ocean Way Recording in Hollywood. The Fairchild was advertised as “The World Accepted Standard for Level Control” back in the 1950’s when it was originally sold. It is still revered for its extremely smooth, artifact-free sound, and now Universal Audio has made it easily accessible to you. And you don’t have to let it warm up for 30 minutes before use!



## Fairchild Screenshot



Figure 34. The Fairchild plug-in window

## 2 Compressors, 4 Modes

There are two compressors within the Fairchild 670. They can be used as dual L/R, dual mono/stereo, or they can be linked together and used on either the L/R or mono/stereo signals.

The mode in which the compressors operate is determined by the combination of the AGC switch and the Sidechain Link switch. See [“Fairchild Modes” on page 123](#) for detailed mode information.

## Controls Overview

Most of the controls are associated with one or the other of the compressors, as opposed to being strictly associated with one channel of input/output (depends on active mode). These controls include Threshold, Time Constant, Bias Current Balance, and DC Bias.

There are two sets of controls that always work on the left and right signals: input level and output level. In Lat/Vert mode, left is the mono input, and right is the stereo input.

Controls on the main panel are all original Fairchild controls, except for the meter select switch which was used to calibrate bias currents on the original hardware. The hardware does not have provision for monitoring input/output or gain reduction levels. For the plug-in, the 'zero' screw-slot control has been disabled, since the meter cannot become uncalibrated on the plug-in.

Controls on the lower auxiliary panel are original controls, modifications, or additions as follows:

- The DC Bias controls are original controls, but were on the back of the hardware units.
- The sidechain link control is a common modification which had been performed on the unit we modeled.
- The Controls Link is a plug-in-only switch.
- The output level controls are an addition for the plug-in.



### Parameter Labels

Some hosts use plug-in parameter names in place of the graphical interface, for example when viewing automation or using control surfaces. Some Fairchild parameters are named with "A" and "B" instead of "L" and "R" because that's how the plug-in operates; depending on the mode (i.e. lat/vert), the channel parameters are not always associated with the left and right channels.

## Fairchild Modes

### Dual Left/Right

In Dual L/R mode, the Fairchild operates as two monophonic compressors with completely independent controls for the left and right channels. There is no interaction between the left and right channels.

### Lateral – Vertical

In Lat/Vert mode, the 670 acts on the lateral and vertical (the sum and difference) components of the two stereo channels. This is accomplished by first bringing the two stereo channels through a matrixing network which divides them into their respective lateral and vertical components, limiting these lateral and vertical components, then recombining them through a second matrixing network into the left and right channels again.

The L+R (mono) signal is sent to one compressor, and the L-R (stereo) signal is sent to the other. The two compressors work independently of each other, and after compression the L and R signals are recovered once again by sum and difference. This mode was created for use in mastering records, where the mono and stereo components of the signal are encoded in this way. It also has application for psychoacoustic processing, since the stereo panning will change dynamically in this mode.

Lat/Vert processing provides maximum usable level and efficient use of available groove space in phonograph mastering. This results in higher volume recordings with longer playing times.

**Note:** *The terms lateral (side-to-side) and vertical (up-and-down) refer to the mechanical modulations in a vinyl record groove that are transduced into electrical audio signals by the phonograph stylus and cartridge.*

### Stereo, coupled left/right

In this mode, the left channel is fed to one compressor, and the right channel is fed to the other. The two compressors are constrained so that they both compress the same amount at any instant. This prevents transients which appear only on one channel from shifting the image of the output. Any big transient on either channel will cause both channels to compress. The amount of compression will be similar to the amount of compression for a transient which appears on both channels at the same time. Also, the attack and release times for the two compressors will be the same, and attack and release behavior will be the average of the settings for the two channels. Mono transients should have an effective attack time of about one half the attack time for transients on only one of the two channels.

## Stereo, coupled mono/stereo

This mode, like stereo couple left/right, causes the two compressors to be linked together so that they always compress the same amount. But here, the inputs to the two compressors are fed with the mono and stereo components of the signal. This means that in general a transient which occurs in both channels will cause a bit more compression than a transient which only appears on left or right. The attack and release behavior is determined by the average of the settings for the two channels.

## Modes Table

The mode in which the compressors operate is determined by the combination of the AGC switch and the Sidechain Link switch. The switch positions required for each mode is shown in [Table 8](#) below.

Table 8. Fairchild Operating Modes

AGC Switch	Sidechain Link	Operating Mode
Left - Right	Unlinked	Dual Left -Right (Dual Mono)
Lat - Vert	Unlinked	Lateral - Vertical (Dual mono - stereo)
Left - Right	Linked	Stereo, couple left - right
Lat - Vert	Linked	Stereo, couple mono - stereo

## Gratuitous Question

Is there any reason I would want to link the two sidechains together and still have the settings for the two channels different?

Yes. Linking the sidechains simply prevents left-right image shifting. Threshold and input gains can be set independently to cause the compressor to be more sensitive to instruments which are panned to one side or the other. Output controls can be set separately in order to correct an overall image shift at the output.

## Controls

### Power Switch

This switch determines whether the plug-in is active. When the Power switch is in the Off position, plug-in processing is disabled and UAD DSP usage is reduced.

### Metering

#### VU Meters

There are two calibrated VU meters, one for each channel. What the Meter displays is determined by the Meter Switch.

### **Meter Select Switch**

This switch determines what is displayed on the VU meters. If GR is selected, the meter will show gain reduction in dB for the corresponding compressor channel (which is not necessarily left or right; depends on the active mode).

If the AGC switch has been set to left/right, the GR shown will be for the left or right channel. If the AGC switch has been set to lat/vert, the GR shown will be for the mono or stereo channel. In GR mode, the upper labels show gain reduction in dB.

If the meter select switch is set to IN or OUT, then that meter will reflect the level of the right or left input or output signal (however, the meters are not calibrated).

### **Zero**

On the hardware unit this screw adjusted the meter pointer to compensate voltage fluctuation and tube wear. Because the meter in the plug-in cannot go out of calibration, this control is permanently disabled.

## **AGC Mode**

This control determines whether the two compression channels will receive L/R or mono/stereo as the inputs. When used in conjunction with the Sidechain Link switch, the operating mode of the compressor can be modified.

See the “Fairchild Modes” on page 123 and Table 8 on page 124 for detailed mode descriptions.

### **Left – Right**

If Left – Right is selected and Sidechain Link is off, the compressor is in dual mono mode. If Sidechain Link is on, the mode is stereo, trigger left/right.

### **Lateral – Vertical**

If Lat/Vert is selected and Sidechain Link is off, the compressor is in lateral/vertical mode and will receive mono/stereo as the inputs. If Sidechain Link is on, the mode is stereo, trigger mono/stereo.

## **Threshold**

This continuously variable control determines the amount of compression to be applied. Turn clockwise for more compression. When fully counter-clockwise, the unit behaves as a simple unity gain line amplifier.

## Time Constant

This 6-position switch provides fixed and variable time constants (attack and release times) to accommodate various types of program material. Positions 1-4 provide successively slower behavior, and 5 and 6 provide program dependent response. The values published by Fairchild for each position are in [Table 9](#) below. The actual measured times are a bit different, but the overall trend is the same.

Table 9. Fairchild Time Constants

Time Constant	Attack Time	Release Time
Position 1	200 microseconds	300 milliseconds
Position 2	200 microseconds	800 milliseconds
Position 3	400 microseconds	2 seconds
Position 4	800 microseconds	5 seconds
Position 5	200 microseconds	Program dependent: 2 seconds for transients 10 seconds for multiple peaks
Position 6	400 microseconds	Program dependent: 300 milliseconds for transients 10 seconds for multiple peaks 25 seconds for consistently high program level

## Sidechain Link

When this control is set to Link, it causes the two channels of the compressor to compress equal amounts. This does not mean that the compressor will be equally sensitive to either channel however; that depends on the settings of the other controls. It simply means that the instantaneous amount of compression for the two channels will always be the same.

## Balance

Balance controls the bias current balance, and always goes with one channel of the compressor, regardless of what the nearby 'metering' switch is set to. The point of perfectly calibrated bias currents is achieved when the "dot" in the screw slot is at 12 o'clock. At this setting, the amount of additive signal deflection ("thud") which happens due to an attack is minimized. Setting this control counter-clockwise from this position results in a thud of one polarity on transients, and going clockwise produces a thud of opposite sign.

**DC Bias**

DC Bias controls the ratio of compression as well as the knee width. As the knob is turned clockwise, the ratio gets lower and the knee gets broader. The threshold also gets lower as the knob is turned clockwise. The 'factory cal' tick mark should be aligned with the screw slot "dot" for factory specification.

It would probably be more technically accurate to say that this control simply changes the knee width, since no matter where it's set the ratio always approaches true limiting eventually. However, the knee becomes so broad that it becomes more practical to speak of the ratio changing, because for reasonable (<25 dB) amounts of compression, this is the case.

**Channel Input Gain**

This is a stepped attenuation control which always applies to left or right input, regardless of the AGC control setting. The steps are approximately 1 dB apart, with approximate unity gain coming at a value of 18, where the gain is -0.33 dB.

In Lat/Vert mode, left is the mono input, and right is the stereo input.

**Output Gain**

These controls always apply to the L and R channels, even when in Lat/Vert mode. The labels around the knobs are in dB and the controls are stepped, 49-position controls, with each step being separated by 0.5 dB.

**Controls Link**

This allows the two sets of controls for the interface to be linked. If the controls are given an offset while unlinked and the controls are subsequently linked, the offset is preserved up to the range of travel of the linked controls.

## CHAPTER 14

# Precision Multiband

### Overview

The Precision Multiband is a specialized mastering tool that provides five spectral bands of dynamic range control. Compression, expansion or gate can be chosen separately for each of the five bands. The unparalleled flexibility and easy to follow graphical design of the Precision Multiband make it the ideal tool for the novice as well as the seasoned mastering engineer.

The Precision Multiband can be used for anything from complex dynamic control to simple de-essing. Two filter bank modes offer precise linear-phase or minimum-phase gain control; use the linear-phase option for perfectly phase-coherent results, or minimum-phase for a more “analog” sound. Both filter bank modes achieve the magnitude response of a Linkwitz-Riley filter and provide perfect magnitude reconstruction.

### Precision Multiband Screenshot

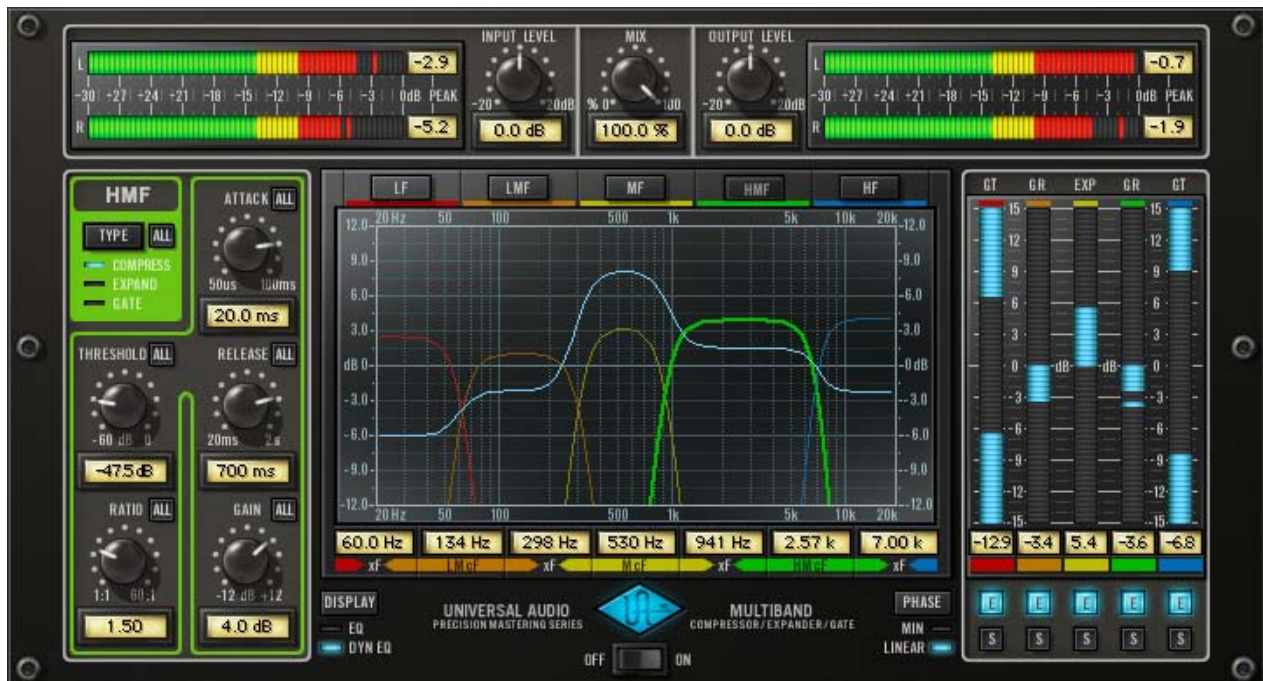

Figure 35. The UAD Precision Multiband plug-in window



## Precision Multiband Interface

The Precision Multiband interface is designed to make this complex processor easier to use.

Five separate frequency bands are available for processing. Each band is identified by a unique color, and all controls specific to the band have the same color. This helps to visually associate parameters to the band that they affect. The band names and their colors are:

- Low Frequency (LF): Red
- Low-Mid Frequency (LMF): Orange
- Mid Frequency (MF): Yellow
- High-Mid Frequency (HMF): Green
- High Frequency (HF): Blue

The interface is divided into four primary areas of control:

- The Band Controls section contains the dynamic response parameters for each of the five bands. One set of band controls is displayed at a time. See [“Band Controls” on page 130](#).
- The EQ Display contains the band frequency parameters and shows a graphic representation of the band frequency response. The overall equalization response is also displayed (if enabled). See [“EQ Display” on page 135](#).
- The Dynamics Meters display the amount of gain reduction or expansion occurring on each band. The band enable and solo controls are here also. See [“Dynamics Meters” on page 138](#).
- The Global controls affect aspects of the plug-in not associated with individual bands. These include input/output controls and meters, power, and other controls. See [“Global Controls” on page 139](#).

## Band Controls



The Band Controls contain the parameters that are used to specify all the settings for each band (except the frequencies; see “Frequency Controls” on page 137).

The Band Controls for each of the five bands are identical.

Only one set of Band Controls is displayed at a time. The control set for any particular band is displayed by selecting the band (see “Band Select” on page 130).

## Band Select

Selecting a band causes the controls for that band to be displayed in the Band Controls area. Bands can be selected by using the Band Select buttons, or by clicking in the EQ display.

### Band Select Buttons

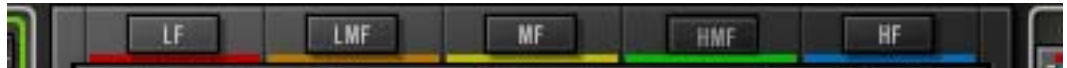

The Band Select buttons at the top of the EQ Display specify which band parameters are displayed in the band controls section. Click the button to display the parameters for the band.

## EQ Display Selection

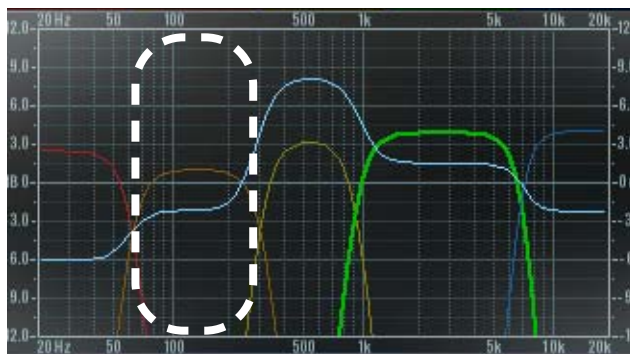

A band can also be selected by clicking within the area of the band in the EQ Display. For example, clicking within the area shown here will select the LMF band.

## Band Parameters

Because the Band Controls for each of the five bands are identical, they are only described once.

### All Button



The ALL button provides a facility to link controls and copy parameter values to all bands when adjusting the current band. Each of the Band Controls has an ALL button. The behavior of the ALL button is the same for all the Band Controls in all the bands (with the exception of the Type switch; see “Type Switch” on page 132)

The ALL button can perform three functions: Relative Link, Absolute Link, and Copy Value. Note that the ALL button cannot be automated.

### Relative Link



In Relative mode, changes to a band control will change the same control in the other bands by a relative amount (i.e. the same amount), until any single band reaches its minimum or maximum value.

Single-click the ALL button to enter Relative mode; the button background changes to blue.

When adjusting a control in Relative mode, it may appear that the full range of the active control is unavailable; this occurs when a different band (not the active band) has reached the end of its range.

In Relative mode the Gain value can also be adjusted by dragging the Gain “handle” in the EQ Display (see “EQ Display” on page 135).

**Note:** No change occurs to the parameter values unless the control is actually moved. This allows you turn off relative linking without making any changes.

**Note:** Relative mode is not available for the Type parameter because the available Type values are discrete. Click and shift-click both activate Absolute mode for Type.

### Absolute Link

 In Absolute mode, changes to a band control will force the same control in the other bands to snap to the same value as the current band.

Shift-click the ALL button to enter Absolute mode; the button background changes to red.

In Absolute mode the Gain value can also be adjusted by dragging the Gain “handle” in the EQ Display (see “EQ Display” on page 135).

**Note:** No change occurs to the parameter values unless the control is actually moved. This allows you turn off absolute linking without making any changes.

### Copy

 Ctrl-click the ALL button when it is NOT in Relative or Absolute modes (not blue or red) to copy the current value of the active band control to the same control value in the other bands.

**Note:** Careful with the control Copy function! It will delete the existing values in the other bands, and no undo is available.

## Type Switch

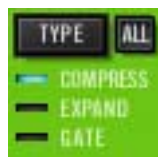

The Type button defines the dynamic nature of the band, allowing each band to function as a compressor, expander, or noise gate, independent of the Type value in the other bands.

Click the Type switch to scroll through the three available values.

The Type text (compress, expand, gate) behaves as a vertical “slider” and can be used for changing the Type as well. Alternately, the Type can be changed using the Dynamics Meters label text (see “Dynamics Meters” on page 138).

**Note:** When changing the band Type, the Ratio value for the band changes to 1:1. This prevents dramatic jumps in the output level that could result from extreme values of other band parameters.

## COMPRESS

When a band is set to Compress, the dynamic range of the band will be reduced (dependent upon the band threshold and input level). This is the typical value in multiband compression.

## EXPAND

When a band is set to Expand, the dynamic range of the band will be increased (dependent upon the band threshold and input level).

## GATE

When a band is set to Gate, the band behaves as a gate. A gate stops the signal from passing when the signal level drops below the specified threshold value.

Gates are generally used to reduce noise levels by eliminating the noise floor when the 'main' signal is not present, but they are also useful for special effects.

## Threshold

This parameter determines the threshold level for compression/expansion/gating. Any signals that exceed this level are processed. Signals below the level are unaffected. A Threshold of 0dB yields no processing. The available range is -60dB to 0dB.

As the Threshold control is decreased and more processing occurs, output level is typically reduced (compression) or increased (expansion). Adjust the Gain control to modify the output of the band to compensate if desired.

## Ratio

Ratio determines the amount of gain reduction (or expansion) for the band. For example: When a band is set to Compress, a value of 2 (expressed as a 2:1 ratio) reduces the signal by half, with an input signal of 20 dB being reduced to 10 dB.

The available range depends on the value of the Type parameter, as follows:

- Ratio range in Compress mode is 1:1 to 60:1
- Ratio range in Expand mode is 1:1 to 1:4
- Ratio range in Gate mode is 1:1 to 8:1

- Attack** Attack sets the amount of time that must elapse once the input signal reaches the Threshold level before processing is applied. The faster the Attack, the more rapidly processing is applied to signals above the threshold.
- The available range is 50 microseconds to 100 milliseconds.
- Release** Release sets the amount of time it takes for processing to cease once the input signal drops below the threshold level. Slower release times can smooth the transition that occurs when the signal dips below the threshold, especially useful for material with frequent peaks. However, if you set too large of a Release time, processing for sections of audio with loud signals may extend to lengthy sections of audio with lower signals. The available range is 20 milliseconds to 2 seconds.
- Gain** The Gain control adjusts the output level of the band. Generally speaking, adjust the Gain control *after* the desired amount of processing is achieved with the Threshold control. The Gain control does not affect the amount of processing. The available range is  $\pm 12$ dB.
- Note: The Gain for each band can also be modified by control points in the EQ Display (see “Curve Control Points” on page 135).*
- Band Frequencies** For details about the band frequencies, see “Frequency Controls” on page 137.
- Band Enable & Solo** For details about the band enable and solo controls, see “Dynamics Meters” on page 138.

## EQ Display

In the EQ Display, the entire audio spectrum from 20Hz to 20KHz is displayed along the horizontal axis. Gain and attenuation of the five band frequencies (up to  $\pm 12$ dB) are displayed along the vertical axis.

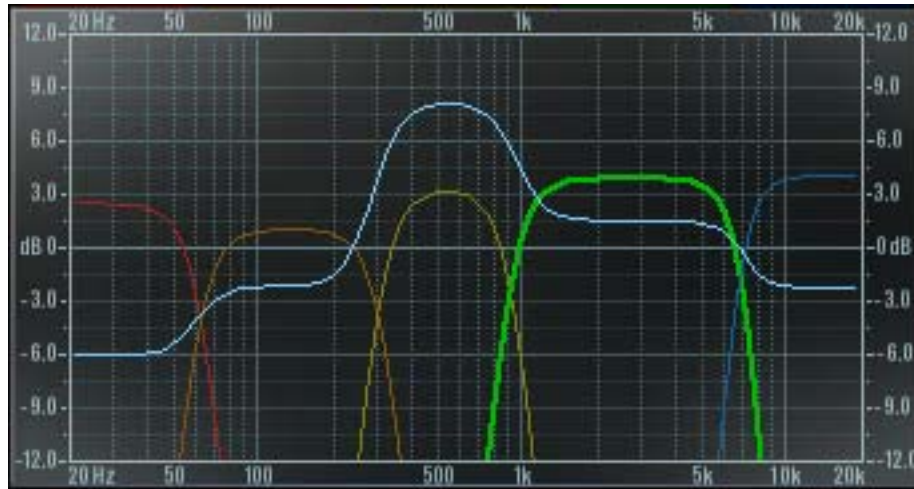

Figure 36. Precision Multiband EQ Display

### Band Curves

The Band Curves show the relative frequency and gain settings of the bands. The sides of the colored curves are a representation of each band's frequency settings, and the top of each curve represents the band's gain setting.

**Note:** The currently selected band is displayed with a thicker bold line. Disabled bands (see “Band Enable & Solo” on page 134) are displayed with a thinner line.

### EQ Response

The EQ Display also shows the processed EQ response dynamically as a light blue line across all bands (if the Dynamic EQ display option is enabled; see “EQ Display Switch” on page 140).

### Curve Control Points

Band gain, center frequencies (cF), crossover frequencies (xF), and bandwidth can be modified by manipulating the colored band curves in the EQ Display with the cursor.

When the cursor is moved over the pre-defined “hot spots” in the EQ Display, the cursor changes shape to indicate that adjustments can be made. Each of these control points and their corresponding available adjustments are detailed below.

### Adjusting Gain

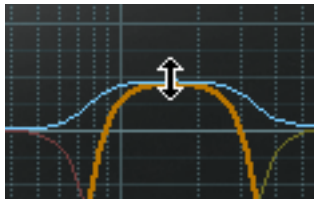

The gain of a band can be adjusted by click-dragging the top of its colored line. In this case the cursor changes to an up/down arrow when hovered over the hot spot to indicate the direction available for dragging.

### Adjusting Gain and cf

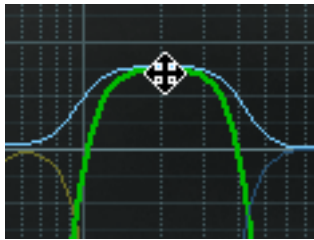

If the cursor is moved slightly lower than the above example, the gain and center frequency can be adjusted simultaneously, without adjusting the bandwidth. In this case the cursor changes to an up/down/left/right arrow when hovered over the hot spot to indicate the direction available for dragging.

### Adjusting Gain and Bandwidth

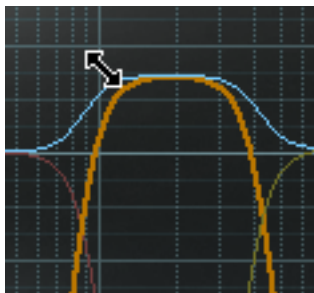

If the cursor is moved to the upper-left region of the three center bands (LMF, MF, HMF), the gain and bandwidth can be adjusted simultaneously, without changing the center frequency. In this case the cursor changes to a diagonal arrow when hovered over the hot spot to indicate the direction available for dragging.

### Adjusting xF

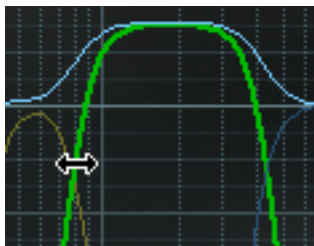

If the cursor is moved to where two bands crossover, the crossover frequencies can be adjusted, without changing the gain or center frequency. In this case the cursor changes to a left/right arrow when hovered over the hot spot to indicate the direction available for dragging.

**Note:** Frequencies can also be adjusted by using the *Frequency Value* parameters (see “*Frequency Values*” on page 137).



## Frequency Controls

The crossover frequency (xF) between the bands and the center frequency (cF) of the Mid bands is shown at the bottom of the EQ Display (see [“EQ Display” on page 135](#)).

The frequencies for each band can be modified by entering the values directly and by manipulating the colored band curves.

### Frequency Values



All band frequency values are always displayed. Values can be input directly using text entry (see [“Text Entry” on page 79](#)).

If a value is entered that is outside of the minimum and maximum allowable value, the entry field will not accept the change and the value for the entry field will remain unchanged.

For the center frequencies, if a value is entered that is still within the acceptable min/max range but the center frequency can not reach the input value because it would require a change to the width, then the nearest allowable value is set. If a lower or greater center frequency value is desired (i.e., the original center frequency value attempt), the width of the band must be reduced first, then the center frequency adjusted again. It's easiest to see the cF limits at the given width by dragging the center frequency with the mouse.

To modify the frequency (and gain) values using the EQ Display, see [“Curve Control Points” on page 135](#)).

## Dynamics Meters



Realtime display of Precision Multiband dynamics processing is shown in the Dynamics Meters. This area also contains the band enable and band solo controls.

There is one vertical dynamics meter for each band. They are color coded to match the bands, and represent (from left to right) the LF, LMF, MF, HMF, and HF bands respectively. Dynamics processing for each band is indicated by light blue "LED-style" metering.

Zero dB is at the center of the meter, and the range is  $\pm 15$  dB. Downward/negative metering indicates compression is occurring on the band. Upward/positive metering indicates expansion is occurring.

In Gate mode, there is simultaneous inward metering from the top and bottom to the center, which provides a visual "gate" that opens and closes along with the gate processing.

Dynamics Meters signal peaks are held for 3 seconds before resetting.

### Meter Labels



The labels above the Dynamics Meters reflect the mode that each band is in: GR (Gain Reduction) for compression, EXP for expansion, and GT for Gate.

### Band Enable Buttons



Each band has an Enable button. The Enable button for the band is just below its dynamics meter.

The band is active when its Enable button is light blue. Click the button to toggle the active state of the band. Disabling bands does not reduce UAD CPU usage.

### Band Solo Buttons



Each band has a Solo button. The Solo button for the band is just below its Enable button.

When one or more bands are in Solo mode, only the soloed bands can be heard and the other bands are muted.

The band is soloed when its Solo button is red. Click the button to toggle the solo state of the band. Soloing bands does not reduce UAD CPU usage.

### Solo Display

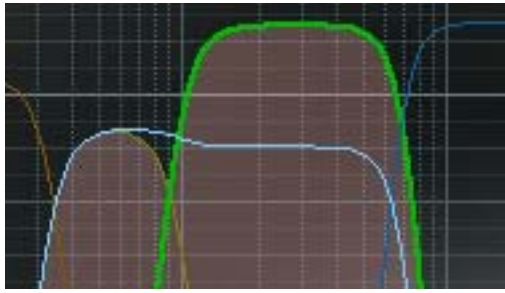

When a band is in Solo mode, its curve in the EQ Display is highlighted.

**Note:** In addition to the Solo buttons, you can also control-click a band in the EQ Display to put any band (or bands) into Solo mode.

### Global Controls

#### Input Level Meter

The stereo peak/hold Input Meter displays the signal level at the input of the plug-in. Signal peaks are held for 3 seconds before resetting.

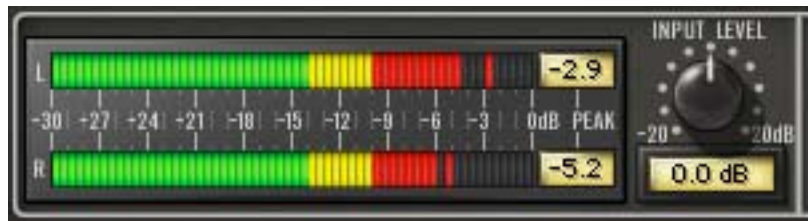

#### Input Level Knob

The Input Level knob controls the signal level that is input to the plug-in. Increasing the input may result in more processing, depending on the values of the band parameters. The default value is 0dB. The available range is  $\pm 20$ dB.

#### Mix

The Mix control determines the balance between the original and the processed signal. The range is from 0% (no dynamics processing) to 100% (wet, processed signal only). The default value is 100%.



Note that at 0% the signal is still being processed by the band splitter in the plug-in. In linear phase mode the splitter is inaudible, but in minimum phase mode you may hear a slight coloration of the signal at 0%.

## Output Level Meter

The stereo peak/hold Output Meter displays the signal level at the output of the plug-in.

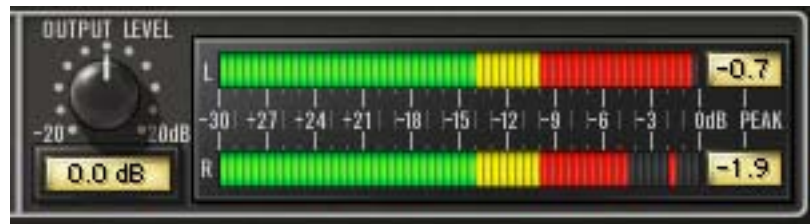

Signal peaks are held for 3 seconds before resetting.

## Output Level Knob

The Output Level knob controls the signal level that is output from the plug-in. The default value is 0dB. The available range is  $\pm 20$ dB.

## EQ Display Switch

The EQ Display mode can be static or dynamic. The EQ Display switch determines the active mode. Click the switch to toggle the mode.

### EQ

In this mode, the EQ Display is static. Only the colored frequency bands are displayed.

### Dynamic EQ

In Dynamic EQ mode, a light blue line in the EQ Display indicates the actual frequency response of the processor in realtime.

## Phase Mode Switch

The filter bank mode of Precision Multiband can be specified with the Phase Mode switch. Click the switch to toggle the mode. The default mode is Linear.

Both filter bank modes achieve the magnitude response of a Linkwitz-Riley filter and provide perfect magnitude reconstruction.

### Linear

Use linear phase mode when perfectly phase-coherent results are desired.

### Minimum

Minimum phase mode provides a more “analog” (i.e., colored) sound and uses slightly less UAD CPU.

While the DSP savings are rather negligible, there is a functional advantage to Min phase mode. When Precision Multiband is used as a track compressor, Min phase mode provides the advantage of rapid response time of the filters for smooth automation and filter sweeps.

## Power Switch

The Power Switch determines whether the plug-in is active. Click the toggle button or the UA logo to change the state.

When the Power switch is in the Off position, plug-in processing is disabled and UAD DSP usage is reduced.

When the plug-in is bypassed with this switch (but not by the host bypass), the I/O meters and the Input Level knob remain active.

## Precision Multiband Latency

The Precision Multiband requires a large processing buffer to perform its sonic wonders. This buffer results in a significantly larger latency than other UAD plug-ins, including all other upsampled plug-ins. You may use Delay-Comp or TrackAdv to compensate. See [“Compensating Upsampled Plug-Ins” on page 95](#) for more information.

**Important:** *Compensating for Precision Multiband latency is not required if the host application supports full plug-in delay compensation throughout the entire signal path, or when it is used only on the outputs. See [“Host PDC Implementation” on page 88](#).*

## CHAPTER 15

# Precision Limiter

### Overview

The Universal Audio Precision Limiter™ is a single-band, look-ahead, brick-wall limiter designed primarily for mastering with program material. The easy-to-use Limiter achieves 100% attack within a 1.5ms look-ahead window, which prevents clipping and guarantees zero overshoot performance. Both the attack and release curves are optimized for mastering, which minimizes aliasing.

Since the Precision Limiter is a colorless, transparent mastering limiter—no up-sampling is used, nor does the UA Precision Limiter pass audio through any filters—audio remains untouched unless the compressor is working, in which case only gain is affected.

To really be considered a professional limiter, the metering needs to be superb. The Precision Limiter features comprehensive, high-resolution metering and conforms to the Bob Katz “K-System” metering specifications. This metering allows the user to see what is happening to audio with a great deal of accuracy, with simultaneous RMS and Peak metering and adjustable Peak Hold. And since we know how valuable good metering is, the plug-in can also be bypassed and used strictly as a high-resolution meter.

Key features include user-adjustable Release or intelligent Auto Release, which allows for fast recovery—minimizing distortion and pumping—and a unique selectable Mode switch, which allows you to delicately tailor the attack shape and control the “presentation” for different material. Mode A is the default shape, suitable for most material, while Mode B can be particularly useful on minimal and/or acoustic program material, yielding a more subtle touch.

The Precision Limiter is yet another indispensable UAD tool for your audio arsenal.

## Precision Limiter Screenshot



Figure 37. The Precision Limiter plug-in window

## Controls Overview

Control knobs for the Precision Limiter behave the same way as all UAD plug-ins. Input, Output, and Release values can be modified with text entry. See [“Text Entry” on page 79](#) for more information.

The Precision Limiter introduced a new control style for UAD plug-ins. For the Mode, Meter, Scale, and Clear parameters, click the parameter label, the value text, or the LED to toggle between available values.

## Precision Limiter Controls

### Input

The Input knob controls the signal level that is input into the limiter. Increasing the input will result in more limiting as the input signal exceeds 0dB.

The default value is 0dB. The available range is  $-6\text{dB}$  to  $24\text{dB}$ .

### Output

The Output knob determines the maximum level at the output of the plug-in. This control does not affect the actual limiting.

The Precision Limiter always limits the signal to 0dB internally, and the actual output is set by attenuating this internal level. Likewise, the input control can drive the signal over 0dB to get more limiting.

If the Precision Limiter is the last processor in the signal path when mixing down to disk (bouncing), the Output value will be the level of the highest peak in the resultant audio file.

The default value is  $-0.10\text{dB}$ . The available range is from  $-12\text{dB}$  to  $0\text{dB}$ . Non-zero values are always negative, therefore during text entry operations positive or negative values may be entered and the result will be negative.

**Release** The Release knob sets the value of the limiter release time. The default value is Auto. The available range is from 1 second to 0.01 milliseconds.

**Auto Mode**

When the Release knob is fully clockwise, Automatic mode is active. In Auto mode, release time is program-dependent. Isolated peaks will have a fast release time, while program material will have a slower release.

**Note:** You can type "A" or "a" to enter Auto mode during text entry.

**Mode** The Mode switch affects the attack shape of the limiter. Subtle tonal variations are possible by switching the Mode between A and B.

Mode A is the default shape, suitable for most material, while Mode B can be particularly useful on minimal and/or acoustic program material, yielding a more subtle touch.

**Power** The Power switch determines whether the plug-in is active. When the Power switch is in the Off position, plug-in processing is disabled and UAD DSP usage is reduced. When the plug-in is bypassed with this switch (but not by the host bypass), the VU meter displays the unprocessed input signal level.

## Precision Limiter Meters Overview

**K-System** The Precision Limiter has precise, calibrated stereo metering. It offers the option to use K-System metering, which is a method devised by renown audio engineer Bob Katz (<http://digido.com>). The K-System is essentially a method of integrating metering and monitoring levels to standardize the apparent loudness of audio material while providing useful visual feedback of average and peak levels.

**Integrated Meter/Monitor System**

The K-System is not just a metering system; it is designed to be integrated with calibrated monitoring system levels. In a full K-System implementation, 0dB on the level meter yields 83dB sound pressure level (SPL) per channel in the monitor output level (86dB running two channels in stereo), when measured with 20-20kHz pink noise on an SPL meter set to C-weighted slow (i.e. average) response. It is this calibrated meter/monitor relationship that establishes a consistent average "perceived loudness" with reference to 0dB on the meter.



### Sliding Meter Scale

With the K-System, programs with different amounts of dynamic range and headroom can be produced by using a loudness meter with a sliding scale, because the moveable 0dB point is always tied to the same calibrated monitor SPL. The Precision Limiter provides several meter ranges for various types of program material (see “Type” on page 145).

### Long Live Dynamic Range!

The K-System can help combat the bane of the “loudness wars” which is all-too common in today’s music, whereby material is made to appear louder when compared to other material at the same playback volume, at the expense of dynamic range and fidelity. Detailed K-System information can be found on the world wide web at:

- [http://digido.com/portal/pmodule\\_id=11/pmdmode=fullscreen/pageadder\\_page\\_id=59](http://digido.com/portal/pmodule_id=11/pmdmode=fullscreen/pageadder_page_id=59)

### Type

The Type switch defines the 0dB point in the meter scale (see “Sliding Meter Scale” on page 145). There are three different K-System meter scales, with 0dB at either 20, 14, or 12 dB below full scale, for typical headroom and SNR requirements of various program materials.

Each of these modes displays the The RMS and instantaneous peak levels, which follow the signal, and the peak-hold level (see “Meter Response” on page 146).

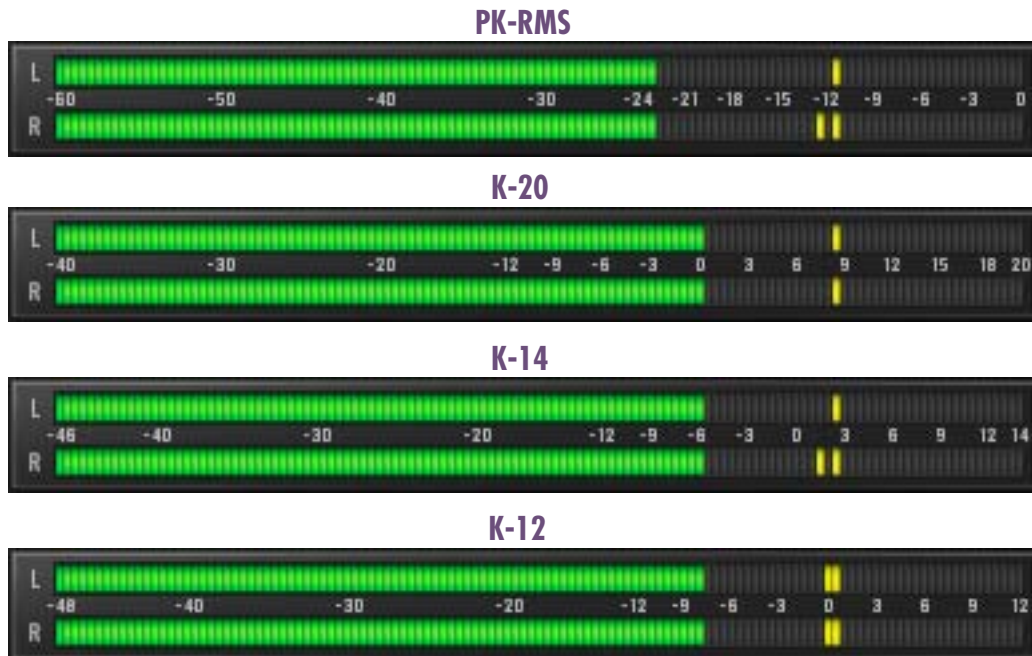

Figure 38. Precision Limiter Meter Types

## K-20

K-20 mode displays 0dB at -20dB below full scale. K-20 is intended for material with very wide dynamic range, such as symphonic music and mixing for film for theatre.

## K-14

K-14 mode displays 0dB at -14dB below full scale. K-14 is intended for the vast majority of moderately-compressed material destined for home listening, such as rock, pop, and folk music.

## K-12

K-12 mode displays 0dB at -12dB below full scale. K-12 is recommended for material intended for broadcast.

## Peak-RMS

This is what is often considered a “normal” digital meter, where 0dB is full-scale digital code.

**Note:** *When the meters are in the K-modes, the displayed RMS level is 3.01dB higher when compared to the same signal level in the Peak-RMS mode. This is done to conform to the AES-17 specification, so that peak and average measurements are referenced to the same decibel value with sine waves.*

## Meter Response

The main stereo Input/Output meter actually displays three meters simultaneously: The RMS and instantaneous peak levels, which follow the signal, and the “peak-hold” (also known as global peak) level.

The peak-hold level is the maximum instantaneous peak within the interval set by the Hold button, and is also displayed as text to the right of the meters. To reset the peak hold levels, press the Clear button.

Precision Limiter metering is also active when plug-in processing is deactivated with the Precision Limiter Power switch. Metering is disabled when the plug-in is bypassed by the host application.

## Gain Reduction Meter

The Gain Reduction meter displays the amount of limiter gain reduction. More green bars moving to the left indicate more gain reduction is occurring.

Gain reduction only occurs when the input signal level exceeds 0dB. Therefore, increasing the Input knob usually results in more gain reduction.

## Meter

The Meter switch specifies the signal source for the main stereo meter, either input or output.

### Input

When the Meter switch is in Input mode, the main level meters display the signal level at the input of the plug-in (and is not affected by the Input knob).

### Output

When the Meter switch is in Output mode, the main level meters display the level at the output of the plug-in. When the Limiter is enabled, the Output and Input knobs will affect this display.

## Scale

The meter Scale switch increases the resolution of the main stereo level meter (See [Figure 39](#) below). The meter range that is displayed in Normal and Zoom modes is dependent upon the meter Type setting (see “Type” on [page 145](#)).

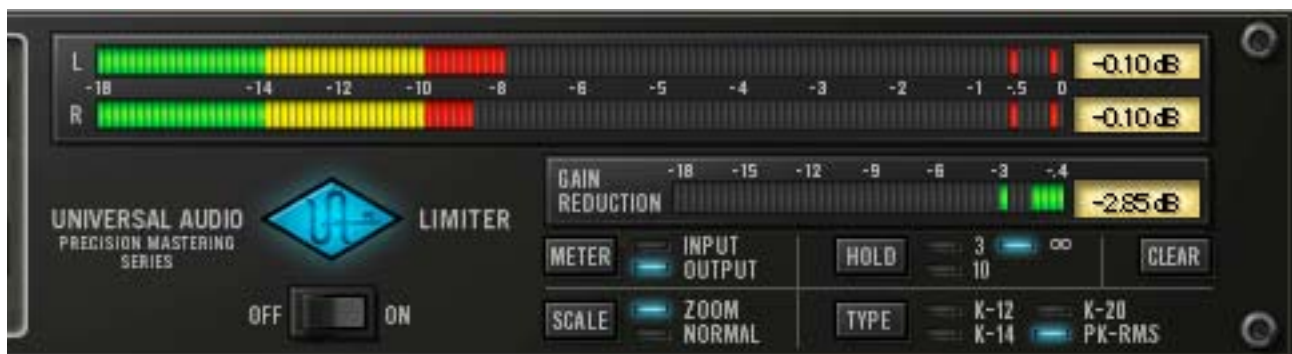

Figure 39. Precision Limiter meter scale in PK-RMS Zoom mode

The main level meters in Normal mode, and the gain reduction meter in both Normal and Zoom modes, are linear (level differences between LED segments is the same). In PK-RMS and K-20 Zoom modes however, the main level meters use two different linear ranges for increased accuracy.

The ranges and response for each meter type and scale is detailed below.

### PK-RMS

In Normal mode, the meter range is  $-60\text{dB}$  to  $0\text{dB}$  with a linear response of  $0.5\text{dB}$  per segment. In Zoom mode, the range is  $-18\text{dB}$  to  $0\text{dB}$  with two different linear responses:  $0.2\text{dB}$  per segment from  $-18$  to  $-6\text{dB}$ , and  $0.1\text{dB}$  per segment from  $-6$  to  $0\text{dB}$ .

## K-20

In Normal mode, the meter range is  $-40\text{dB}$  to  $20\text{dB}$  with a linear response of  $0.5\text{dB}$  per segment. In Zoom mode, the range is  $-8\text{dB}$  to  $20\text{dB}$  with two different linear responses:  $0.2\text{dB}$  per segment from  $-8$  to  $15\text{dB}$ , and  $0.1\text{dB}$  per segment from  $15\text{dB}$  to  $20\text{dB}$ .

## K-14

In Normal mode, the meter range is  $-46\text{dB}$  to  $14\text{dB}$  with a linear response of  $0.5\text{dB}$  per segment. In Zoom mode, the range is  $-10\text{dB}$  to  $14\text{dB}$ , with linear response of  $0.2\text{dB}$  per segment.

## K-12

In Normal mode, the meter range is  $-48\text{dB}$  to  $12\text{dB}$  with a linear response of  $0.5\text{dB}$  per segment. In Zoom mode, the range is  $-12\text{dB}$  to  $12\text{dB}$ , with linear response of  $0.2\text{dB}$  per segment.

### Hold

The meter Hold Time switch determines how much time will pass before the peak values for the main meter and the gain reduction meter are reset. It affects both the peak LED's and the peak text display.

Values of 3 seconds, 10 seconds, or Infinite (indicated by the lazy-8 symbol) can be selected.

### Clear

The meter Peak Clear switch clears the meter peak value display. It affects both the peak LED's and the peak text display.

## Precision Limiter Latency

The Precision Limiter has a  $1.5\text{ms}$  look-ahead window to ensure clipping does not occur. This look-ahead function results in a slightly larger latency than other UAD plug-ins. You may use DelayComp or TrackAdv to compensate. See ["Compensating Upsampled Plug-Ins"](#) on page 95 for more information.

**Note:** *Compensating for Precision Limiter is not required if the host application supports full plug-in delay compensation throughout the signal path, or when it is used only on the outputs. See ["Host PDC Implementation"](#) on page 88.*

## CHAPTER 16

# Precision Buss Compressor

### Overview

The Precision Buss Compressor is a dual-VCA-type dynamic processor that yields modern, transparent gain reduction characteristics. It is specifically designed to “glue” mix elements together for that cohesive and polished sound typical of master section console compressors. A flexible and intuitive tool, the Precision Buss Compressor is intended primarily for controlling the final output of your mix, but can be usefully applied to a variety of sources from drum busses or overheads to vocal groups, or even as a channel compressor on individual track inserts.

The Precision Buss Compressor’s control set features Threshold, Ratio, Attack and Release, with all parameters specifically tailored to buss compressor usage. The Release control includes a multi-stage Auto Release also designed for a wide variety of program material. Input and Output Gain control is offered with metering for input, output and gain reduction. A high pass Filter is offered for the internal control signal sidechain to reduce the sensitivity of the compression to lower frequencies while retaining them in the output signal. An automatic Fade feature is included, which allows the user to set a custom fade-out or fade-in of the mix between 1 and 60 seconds long. Rounding out the feature set is a Mix control that allows the user to achieve “parallel” style dynamics control, without the need for a second buss or channel.

## Precision Buss Compressor Screenshot



Figure 40. The Precision Buss Compressor plug-in window

## Precision Buss Compressor Controls

Control knobs for the Precision Buss Compressor behave the same way as with all UAD plug-ins. Parameters with text values can be modified with text entry. See “Text Entry” on page 79 for more information.

### Filter



Filter regulates the cutoff frequency of the filter on the compressor's control signal sidechain. Removing low-frequency content from the sidechain can reduce excessive gain reduction and/or “pumping” on bass-heavy audio signals without reducing bass content of the audio signal itself.

The filter is an 18dB per octave, coincident-pole high-pass filter. The available range is 20Hz–500Hz and Off.

**Note:** The Filter parameter affects the control signal (sidechain) of the compressor only. It does not filter the audio signal.

### Threshold



This parameter determines the threshold level for the onset of compression. Incoming signals that exceed this level are compressed. Signals below the level are unaffected.

The available threshold range depends on ratio setting. At higher Ratio values, more headroom is available. Since the plug-in is designed primarily as a buss compressor, where signal levels typically run hotter than individual tracks, this feature increases the control resolution for fine-tuning these higher levels.

When Ratio is changed, the Threshold value is updated accordingly:

When Ratio is set to 2:1, the Threshold range is -55dB to 0dB.

When Ratio is set to 4:1, the Threshold range is -45dB to +10dB.

When Ratio is set to 10:1, the Threshold range is -40dB to +15dB.

**Note:** When Ratio is changed, Threshold numerical values are updated but the Threshold knob position does not move.

As the Threshold control is decreased and more compression occurs, output level is typically reduced. Adjust the Gain control to modify the output to compensate if desired.

### Ratio



Ratio determines the amount of gain reduction for the compressor. For example, a 2:1 ratio reduces the signal above the threshold by half, with an input signal of 20dB being reduced to 10dB.

The available Ratio values are 2:1 (default), 4:1, and 10:1.

### Attack



Attack sets the amount of time that must elapse once the input signal reaches the Threshold level before compression is applied. The faster the Attack, the more rapidly compression is applied to signals above the threshold.

The Attack range is from 0.10 milliseconds to 32 milliseconds. The availability of relatively slow attack times (as compared to other compressors) is one factor that can provide the in-your-face-pumping quality that is so popular with large console VCA-style compressors.

### Release



Release sets the amount of time it takes for compression to cease once the input signal drops below the threshold level.

The available range is from 0.10 seconds to 1.20 seconds, with Automatic release available at the full-clockwise position.

The Auto release characteristic for Precision Buss Compressor has a unique quality that is optimized for program material.

Slower release times can smooth the transition that occurs when the signal dips below the threshold, especially useful for material with frequent peaks. However, if you set too large of a Release time, compression for sections of audio with loud signals may extend to lengthy sections of audio with lower signals.

## Fade

The Precision Buss Compressor provides a Fade function that, upon activation, automatically reduces the plug-in output to minimum within a specified time period. This function enables extremely smooth-sounding fade outs (and fade ins), plus it can be automated as well. The Fade function processes the signal at the output of the compressor.



### Fade Set

Fade Set determines the amount of time that will pass between the Fade button being activated and the plug-in output level being reduced to minimum (or being raised to 0dB in the case of a fade in). The available range is from 1.0 second to 60 seconds.

Fade times immediately reflect the current Fade Set value. Therefore a fade out that has already been initiated can be accelerated by changing Fade Set during the fade out. Conversely, a fade in can be accelerated by changing Fade Set during the fade in.

Note that although the Fade Set control itself has linear taper, the fade signal level that is output has an exponential curve.



### Fade Switch

Activating the Fade switch initiates a fade out. The fade out time is determined by the Fade Set parameter.



The Fade switch flashes red when a fade out is in progress, and glows solid red when the fade out is complete (when the Fade Set time has elapsed).

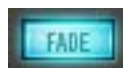

Deactivating Fade initiates a fade in. During a fade in, the signal level is increased from the current level of attenuation to 0dB of attenuation. The Fade switch flashes blue when a fade in is in progress, and is no longer illuminated when the fade in is complete (when the Fade Set time has elapsed).



Toggling the Fade switch causes an already active fade to reverse direction, without a jump in output level. The Fade Set rate is constant even if an active fade is interrupted. For example: If the Fade Set value is 30 seconds and a fade out is initiated, then Fade is clicked again after 20 seconds, it will take 20 seconds to fade back in.

**Note:** Shift+click the Fade button to instantly return the level back to 0dB (this feature cannot be automated).

### Input Level



Input controls the signal level that is input to the plug-in. Increasing the input may result in more compression, depending on the values of the Threshold and Ratio parameters.

The default value is 0dB. The available range is  $\pm 20$ dB.

### Mix



The Mix control determines the balance between the original and the processed signal. The range is from 0% (dry unprocessed signal only) to 100% (wet processed signal only). The default value is 100%.

### Output Level



Output controls the signal level that is output from the plug-in. The default value is 0dB. The available range is  $\pm 20$ dB.

Output controls both the dry unprocessed and wet processed signals (as determined by the Mix control).

Generally speaking, adjust the Output control after the desired amount of compression is achieved with the Threshold and Ratio controls. Output does not affect the amount of compression.

### Level Meters



The stereo peak/hold Input and Output Meters display the signal level at the input and output of the plug-in.

The range is from -30dB to 0dB. Signal peaks are held for 3 seconds before resetting.

## Gain Reduction Meter



The Gain Reduction meter displays the amount of gain reduction occurring within the compressor.

More blue bars moving to the left indicate more gain reduction is occurring.

The meter range is from -16dB to 0dB. Signal peaks are held for 3 seconds before resetting.

## Power



The Power switch determines whether the plug-in is active. Click the toggle button or the UA logo to change the state.

When the Power switch is in the Off position, plug-in processing is disabled and UAD DSP usage is reduced. When the plug-in is bypassed with this switch (but not by the host bypass), the I/O meters and the Input Level knob remain active.

## Extra Presets

Extra presets for the UAD Precision Buss Compressor that are not in the factory bank can be downloaded from our website. These presets replicate all the fixed attack and release setting combinations that are found on large console VCA-style compressors. The extra presets can be found here:

<http://www.uaudio.com/support/software/UAD/downloads-support.html>

## WebZine Article

An interesting article about the Precision Buss Compressor is available in the "Ask The Doctors" section of our December 2007 WebZine:

- <http://www.uaudio.com/webzine/2007/december/index2.html>

# Neve 33609 Compressor

### Overview

Derived from the original Neve 2254 compressor, circa 1969, the 33609 stereo bus compressor/limiter utilizes a bridged-diode gain reduction circuit and many custom transformers. The uniquely musical character of this circuit made the 33609 a studio standard since its release. The UAD Neve 33609 is the only Neve-sanctioned software recreation of the Neve 33609 (revision C). Every detail of the original unit is captured, and matches its hardware counterpart with absolute precision. The 33609 plug-in includes a DSP-optimized 33609SE which allows for higher instance counts.

The completely step-controlled 33609 is made up of separate compression and limiter sections, each with their own threshold, recovery and bypass controls. Two of the recovery selections for each section are dedicated to a program dependent auto release. The compressor section also offers five ratio selections and 20 dB make-up gain, while the limiter offers a fast or slow attack. The mono/stereo switch couples and decouples the left and right gain reduction elements.

The UAD Powered Plug-In version of the Neve 33609 adds a few control enhancements not found on the hardware: An additional stepped output control with 20db of gain, a link switch allowing ganged left/right control of all parameters, and a headroom switch, which allows the DAW user to take advantage of the full range of 33609 gain coloration.

## Neve 33609 Screenshot



Figure 41. The Neve 33609 plug-in window

## Operation

The UAD Neve 33609 is a two-channel device capable of running in stereo or dual-mono modes. The active mode is determined by the mono/stereo switch (see “[Mono/Stereo](#)” on page 160). When the 33609 is used in a mono-in/mono-out configuration, the channel 2 controls are disabled.

Each channel consists of a compressor and a limiter. Each of these functions has its own separate group of controls. Since the controls for each of the two channels are identical, they are detailed only once.

**Note:** For a detailed explanation on how compressors and limiters operate, see “[Compressor Basics](#)” on page 109.

## Signal Flow

In the 33609, the output of the compressor is fed to the input of the limiter. Like the original hardware, the signal does not flow “from the left to the right” of the interface. Understanding this signal flow will help you obtain a more predictable result (see [Figure 42](#) below).

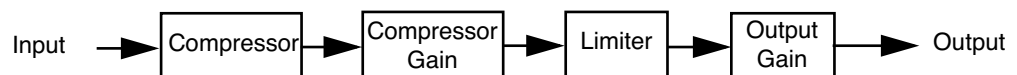

Figure 42. Signal flow within UAD Neve 33609

## Modeling

The UAD Neve 33609 models all aspects of the original 33609 hardware, including the desirable harmonic distortion characteristics. These qualities are more prominent at higher input levels (see “[Headroom](#)” on page 161” for more info).

When the compressor and limiter are both disabled, some (good) coloration of the signal occurs, just like the hardware. If a true bypass is desired, use the power switch (“[Power](#)” on page 163) to disable the plug-in.

**Technical Article** The article “Ask the Doctors: Modeling of the Neve 33609 compressor/limiter” contains interesting technical details about the 33609. It is available at our online webzine:

- <http://www.uaudio.com/webzine/2006/august/index2.html>

## Neve 33609 Controls

Each feature of the UAD Neve 33609 interface is detailed below.

### Limiter



Controls in this section only function when the limiter is enabled with the “limit In” switch (the Power switch must also be on).

**Note:** The compressor precedes the limiter (see “Signal Flow” on page 156).

### Limiter Threshold

Threshold determines how much limiting will occur. When the input signal exceeds the threshold level, the signal above the threshold is limited. A smaller value results in more limiting. The available range is from +4dB to +15dB, in .5dB increments.

If the compressor is enabled, the Gain control in the compressor section (“Compressor Gain” on page 158) will affect the input level into the limiter. In this case, the compressor gain can affect the limiter threshold response.

### Limiter Recovery

Recovery (release) is the time it takes for the limiter to stop processing after the signal drops below the threshold value. The available values (in milliseconds) are 50, 100, 200, 800, a1, and a2.

The automatic settings (a1 and a2) are program dependant. The value for a1 can be as fast as 40ms, but after a sustained period of high signal level, the period is  $\approx 1500$ ms. The value for a2 can be as fast as 150ms, but after a sustained period of high signal level, the period is  $\approx 3000$ ms.

### Limiter In

This toggle switch enables the limiter portion of the plug-in. The limiter has no effect unless this switch is in the “In” (down) position.

## Attack

Attack determines how fast limiting will engage when the signal exceeds the limiter threshold. The Fast setting is 2 milliseconds, and the Slow setting is 4 milliseconds.

## Compressor



Controls in this section only function when the compressor is enabled with the “compress In” switch (the Power switch must also be on).

**Note:** The compressor precedes the limiter (see “Signal Flow” on page 156).

### Compressor Threshold

Threshold determines how much compression will occur. When the input signal exceeds the threshold level, the compressor engages. A smaller value results in more compression. The available range is from -20dB to +10dB, in 2dB increments.

### Compressor Recovery

Recovery (release) is the time it takes for the compressor to stop processing after the signal drops below the threshold value. The available values (in milliseconds) are 100, 400, 800, 1500, a1, and a2.

The automatic settings (a1 and a2) are program dependant. The value for a1 can be as fast as 40ms, but after a sustained period of high signal level, the period is ≈800ms. The value for a2 can be as fast as 150ms, but after a sustained period of high signal level, the period is ≈1500ms.

### Compressor Gain

This makeup gain control increases the signal level out of the compressor to compensate for reduced levels as a result of compression. The available range is 0 to +20dB, in 2dB increments.

Make sure to adjust the Gain control *after* the desired amount of compression is achieved with the Threshold control. The Gain control does not affect the amount of compression.

**Note:** If the limiter is also enabled, this gain is applied before the limiter stage.

**Ratio** This control determines the compressor ratio. The available values are 1.5:1, 2:1, 3:1, 4:1, and 6:1, selectable in discrete increments.

**Compressor In** This toggle switch enables the compressor portion of the plug-in. The compressor has no effect unless this switch is in the “In” (down) position.

## Other Controls



The interface elements that are not directly contained within the compressor or limiter are detailed below.

**Output Gain** This control is a software-only addition not found on the original hardware. It is an overall makeup gain stage at the output of the plug-in to compensate for reduced levels as a result of compression and/or limiting. The available range is -2 to +20 in 1 dB increments.

**Gain Reduction Meters** The Gain Reduction Meters indicate the amount of gain reduction that is occurring in dB. There is one meter for each channel. The gain reduction displayed is the total reduction of the limiter plus the compressor.

***Note:** The meter indicator moves farther to the right as more gain reduction is occurring. This meter behavior is opposite that of many compressors.*

**Link** This switch is a software-only addition that allows the two sets of controls for each channel to be linked for ease of operation when both channels require the same values, or unlinked when dual-mono operation is desired. The Link parameter is stored within presets and can be accessed via automation.

### **Unlink**

When set to unlink (up position), the controls for channels one and two are completely independent. Unlink is generally used in mono mode. When unlinked, automation data is written and read by each channel separately.

***Note:** When unlink is switched to link, channel 1 controls are copied to channel 2. Control offsets between channels are lost in this case.*

### **Link**

When set to link (down position), modifying any channel one or channel two control causes its adjacent stereo counterpart control to snap to the same position (channel 1 & 2 controls are ganged together in link mode).

When link is active, automation data is written and read for channel one only. In this case, the automation data for channel one will control both channels.

***Note:** When link is active, changing channel two parameters from a control surface or when in "controls only" (non-GUI) mode will have no effect.*

## **Mono/Stereo**

The Neve 33609 can operate in true stereo or dual-mono mode. This switch determines the active mode.

### **Mono**

In mono mode, channels 1 and 2 are completely independent and the 33609 functions as a dual-mono device, each channel with its own compressor and limiter.

***Note:** To read and write automation data for both channels independently when in mono mode, link mode must be disabled.*

### **Stereo**

In stereo mode, the left channel is fed to the channel one compressor, and the right channel is fed to the channel two compressor. The two compressors are constrained so that they both compress the same amount at any instant. This prevents transients which appear only on one channel from shifting the image of the output. Any big transient on either channel will cause both channels to compress. The amount of compression will be similar to the amount of compression for a transient which appears on both channels at the same time.



In stereo operation the controls for channels 1 and 2 are independent and can be set separately. Generally, the channel with the “most processing occurring” controls the processing for the other channel. For example, if the same signal is fed to both channels in stereo mode and channel 1 has a lower threshold setting than channel 2, the channel 1 threshold value is used for both channels. Similarly, if channel 1 were disabled (using “In” switches), channel 2 settings would be used because “more processing” occurs with the channel 2 settings. It's not always so simple though, as in the following cases:

- If you feed the same signal into both channels, you can have a lower threshold with a lower ratio on one channel, and a higher threshold with a higher ratio on the other channel. In this case, you will get a double knee, with the lower ratio being used between the knees, and the higher ratio above both knees.
- If you feed the same signal into both channels, you can have a lower threshold with a faster release on one channel, and a higher threshold with a slower release in the other channel. In this case, you will get a two-stage release after a transient, with the first channel releasing at the fast rate until you get down to where the other one is; then the release will continue at the slower rate.

#### **Gratuitous Question**

Is there any reason I would want to use stereo mode and still have the settings for the two channels different?

Yes. Linking the sidechains simply prevents left-right image shifting. Threshold, attack, and recovery can be set independently to cause the compressor to be more sensitive to instruments which are panned to one side or the other. Output controls can be set separately in order to correct an overall image shift at the output.

## **Headroom**

### **Background**

The hardware Neve 33609 can accept an analog signal level of approximately +26dBu before undesirable signal clipping occurs. As the signal increases up to this point however, desirable audio-path nonlinearities and “good” harmonic distortion characteristics occur. This musically pleasing “warmth” at higher levels is what gives the unit much of its revered sonic character. Because analog mixing consoles can typically output high signal levels, audio engineers often take advantage of the ability to “push” the hardware 33609 into the colorful arena.

This complete pallet of sonic nuance, including the dynamic input response, is captured in the UAD Neve 33609 model. The plug-in is calibrated internally so that 0dBFS at its input is equivalent to an input level of approximately +26dBu on the 33609 hardware, where the coloring is more prominent. The result is that a typical signal within a DAW will drive the UAD Neve 33609 into these “virtual” higher levels, resulting in fairly high amounts gain reduction.

### **Headroom Switch**

The Headroom switch is provided to accommodate applications where high amounts of gain reduction are not desired. Headroom simply lowers the internal operating level so that the plug-in is not “pushed” into gain reduction as much.

Headroom can be set to 22db, 18db, or 14db. At 22dB, signals will push the plug-in into gain reduction (and more non-linearity and “good” harmonic distortion) more easily. Set the switch to a lower value when less gain reduction and color is desired.

The numbers on the switch indicate where 0dBFS falls relative to nominal +4dBu. For example, with 22dB of headroom, 0dBFS corresponds to +4dBu + 22dB = 26dBu. With 18dB of headroom, 0dBFS corresponds to +4dBu + 18 db = 22dBu. The headroom selected will cause the plug-in to behave as though it were a hardware 33609 connected to a nominal +4dBu interface with the selected amount of headroom. Industry standards for most DAW interfaces are +14dB and +18dB headroom. The +22dB setting approximates some analog mixing environments, and allows the entire useful dynamic range of the 33609 to be exercised.

The following settings are application guidelines for the Headroom switch:

#### **22dB**

Typical starting point for individual track inserts where maximum gain reduction is desired. This setting is equivalent to having a real hardware 33609 connected to a +4 interface with +22dB headroom.

#### **18dB**

Typical starting point for buses and groups where nominal gain reduction is desired. This setting is equivalent to having a real hardware 33609 connected to a +4 interface with +18dB headroom.

## 14dB

Typical starting point for mastering where minimal gain reduction is desired. This setting is equivalent to having a real hardware 33609 connected to a +4 interface with +14dB headroom.

***Note:** Keep in mind there are no hard and fast rules. Use the above recommendations as guidelines and feel free to experiment with the various positions of the headroom switch regardless of the audio source. If it sounds good, use it!*

## Factory Presets

The UAD Neve 33609/33609SE includes a bank of factory presets. These presets can be useful starting points for your particular source audio.

The factory preset names begin with MSTR, BUSS, or TRAK. These indicate the setting of the headroom parameter. (14dB, 18dB, and 22dB respectively).

Mastering (MSTR) presets are optimized for mixed program material that is already at a relatively high level.

Buss/group (BUSS) presets are optimized for subgroups of audio, such as a drum group or vocal group. This type of application often has lower levels than full mixes, but higher levels than a track insert.

Track (TRAK) presets are optimized for track inserts where signal levels typically aren't as hot as groups or outputs.

The preset names are guidelines and not rules. In many cases, you can use any preset on any source with good results. You will probably need to adjust the threshold and/or gain controls to obtain the optimum results with your particular source audio.

## Power

The Power switch determines whether the plug-in is active. This is useful for comparing the processed settings to that of the original signal, or to bypass the plug-in to reduce the UAD DSP load. Toggle the switch to change the Power state; the switch is illuminated in red when the plug-in is active.

***Note:** You can click-hold the power switch then drag it like a slider to quickly compare the enabled/disabled state.*

## Neve 33609SE



Figure 43. The Neve 33609SE plug-in window

### Overview

The UAD Neve 33609SE is derived from the UAD Neve 33609. Its algorithm has been revised in order to provide sonic characteristics very similar to the 33609 but with significantly less DSP usage. It is provided to allow 33609-like sound when DSP resources are limited. Nobody with “golden ears” will claim it sounds exactly like the 33609, but it still sounds great and is very usable in most situations.

The 33609SE interface can be differentiated from the 33609 by color and the module name. The 33609SE background is black instead of the 33609’s blue/grey, and the module name below the link switch includes “SE”.

### Neve 33609SE Controls

The Neve 33609SE controls are exactly the same as the Neve 33609. Please refer to the Neve 33609 section for Neve 33609SE control descriptions (see “[Neve 33609 Controls](#)” on page 157).

### Neve 33609 Latency

The Neve 33609 (but not the 33609SE) uses an internal upsampling technique to facilitate its amazing sonic quality. This upsampling results in a slightly larger latency than other UAD plug-ins. You may enter a value in the “Samples” parameter in DelayComp or TrackAdv to compensate. See “[Compensating Upsampled Plug-Ins](#)” on page 95 for more information.

The Neve 33609SE does not require additional latency compensation because it is not upsampled.

**Note:** *Compensating for Neve 33609 is not required if the host application supports full plug-in delay compensation throughout the signal path, or when it is used only on the outputs. See “[Host PDC Implementation](#)” on page 88.*

Neve® and 33609® are registered trademarks of AMS-Neve, England and are used under license with kind permission from Neve.

## CHAPTER 18

# VCA VU

### Overview

The VCA VU Compressor/Limiter is a faithful emulation of the first commercially available VCA (Voltage-Controlled Amplifier) compressor, the dbx 160. Originally designed and sold by David Blackmer in 1971, this solid-state design set the standard for performance and affordability. “VU” is the common nickname for this widely regarded studio staple, famous for its simple control set and firm compression characteristics. The original unit is still considered the very best VCA compressor ever made. Unlike later monolithic IC units, the “VU” uses a series of discrete components for gain reduction, and therefore has unique nonlinearities not found in other VCA compressors—thus giving it a sonic distinction from later models. The VCA VU captures all the sonic nuances from our “golden” modeling unit and the simple control set of the hardware, including Threshold, Compression (Ratio) and Output Gain. Like the hardware, LED threshold indicators are provided, as well the Input/Output/Gain Change VU meter for which the unit is famous.

### VCA VU Screenshot



Figure 44. The VCA VU plug-in window

## VCA VU Controls

The minimal controls on the UAD VCA VU make it very simple to operate.

### Threshold



#### Knob

The Threshold knob defines the level at which the onset of compression occurs. Incoming signals that exceed the Threshold level are compressed. Signals below the Threshold are unaffected.

The available range is from -55dB to 0dB. The numbers on the graphical interface indicate volts, as on the original hardware.

As the Threshold control is decreased and more compression occurs, output level is typically reduced. Adjust the Output Gain control to increase the output to compensate if desired.

#### Below

When the input signal is below the compression threshold value, the Below LED illuminates. No compression is occurring when Below is lit.

#### Above

The Above LED illuminates when the input signal has exceeded the Threshold value, indicating that compression is occurring. The higher the signal is above the Threshold, the brighter the LED glows.

### Compression



The Compression parameter determines the ratio for the compressor. Less compression occurs at lower values. The available range is continuous, from 1.00:1 to Infinity:1.

**Note:** For compression to occur, signals must exceed the Threshold value.

At values above approximately 10:1, the compressor behaves more like a peak-limiter. See [“Compressor Basics” on page 109](#) for more information about compressor/limiter theory of operation.

## Output Gain



Output Gain controls the signal level that is output from the plug-in. The available range is  $\pm 20$ dB.

Generally speaking, adjust the Output control after the desired amount of compression is achieved with the Threshold and Compression controls. Output does not affect the amount of compression.

## Meter Buttons



The Meter buttons define the mode of the VU Meter. The buttons do not change the sound of the signal processor. The active button has a darker appearance when compared to the inactive buttons.

## VU Meter



When set to Input, the VU Meter indicates the plug-in input level in dB. When set to Output, the VU Meter indicates the plug-in output level in dB. When set to Gain Change, the VU Meter indicates the amount of Gain Reduction in dB.

## Power



The Power switch determines whether the plug-in is active. Click the button to toggle the state. When the Power switch is in the Off (lighter) position, plug-in processing is disabled and UAD DSP usage is reduced.

## WebZine Articles

Some interesting technical articles are available in our online Webzine at [www.uaudio.com](http://www.uaudio.com):

### Ask the Doctors: Signal Detection in the dbx 160

- <http://www.uaudio.com/webzine/2008/march/index2.html>

### Analog Obsession: David Blackmer and the dbx 160

- <http://www.uaudio.com/webzine/2008/march/index4.html>

### Ask the Doctors: VCA Compressors

- <http://www.uaudio.com/webzine/2007/december/index2.html>

# Neve 88RS Channel Strip

### Overview

In 2001, Neve launched the 88 Series: A new, large-format analog console that represented the best of all Neve designs that came before it. Considered the ultimate console for modern features and reliability, it is also heralded as one of the best-sounding consoles ever made by veterans of both the audio and film communities. The 88RS has found a home in some of the finest rooms and scoring stages around the world, including Ocean Way, Abbey Road, AIR, The Village, Sony Pictures, 20th Century Fox and Skywalker Sound.

With a rich palette of modern sound-sculpting tools, the Neve 88RS Channel Strip captures the EQ and dynamics section from Neve's flagship console. The controls comprise 12 dB per octave high and low cut filters, a four-band EQ plus limiting, compression, gate and expansion. The middle EQ bands are fully parametric, while the flexible high and low bands provide the user with two fixed-Q types and the ability to switch to shelving EQ.

The VCA-type Limit/Comp provides a 0.01 to 3s release, Auto Release and a continuously variable ratio control with a fixed fast or slow attack time. The Gate/Exp provides 0.01 to 3s release times, fast or slow attack times plus Threshold, Range and Hysteresis to tailor your gate or expansion effect to the perfect response for any source.

Additionally, the user may engage the P-DYN button to reorder the signal chain so that the EQ is first. With the SC-EQ button, the user may engage a sidechain feature to achieve frequency-dependent compression for such useful tasks as de-essing.



# Neve 88RS Screenshot



Figure 45. The Neve 88RS plug-in window

## Neve 88RS Controls

### Overview

The UAD Neve 88RS controls are divided into four main sections: dynamics, EQ, cut filters, and global. Each section and control is detailed below.

In the UAD Neve 88RS plug-in, 0dBFS is calibrated to +4dBu plus 18dB of headroom, so 0dBFS is equivalent to 22dBu.

### Signal Flow

The output of the cut filters is fed to the input of the dynamics or EQ section (dependent upon the Pre-Dyn switch). Understanding this signal flow will help you obtain a more predictable result (see [Figure 46](#) below).

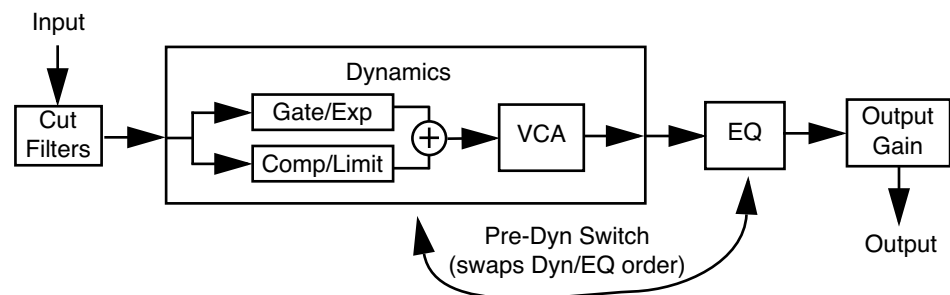

Figure 46. Simplified signal flow within UAD Neve 88RS

## Dynamics

The dynamics section consists of a gate/expander and a limiter/compressor. The controls for each of these two dynamics processors are arranged in vertical columns, with the gate/expander controls in the left column, and the limiter/compressor controls in the right column. Both processors can be individually activated or disabled.

The settings of the gate do not affect operation of the compressor, and vice versa. The same sidechain signal (EQ'd or not, depending upon Pre EQ switch) is sent to both the gate and compressor. The gains for both the gate and compressor are computed based on that same signal, then both the gate and compressor gains are applied in the same place, by a single gain-reduction VCA (see [Figure 46](#) above).



## Gate/Expander

The gate/expander module operates in either gate or expansion mode. In gate mode, signals below the threshold are attenuated by the range (RGE) amount (see [Figure 47 on page 171](#)), and hysteresis is available (see [Figure 48 on page 172](#)).

Expansion mode is enabled by rotating the hysteresis (HYST) control fully counter-clockwise (or clicking the EXP label). In expansion mode, the gate applies downwards expansion at a fixed 1:2 ratio, with the amount of gain reduction determined by the range control. Two attack speeds and a continuously variable release time are available in both modes.

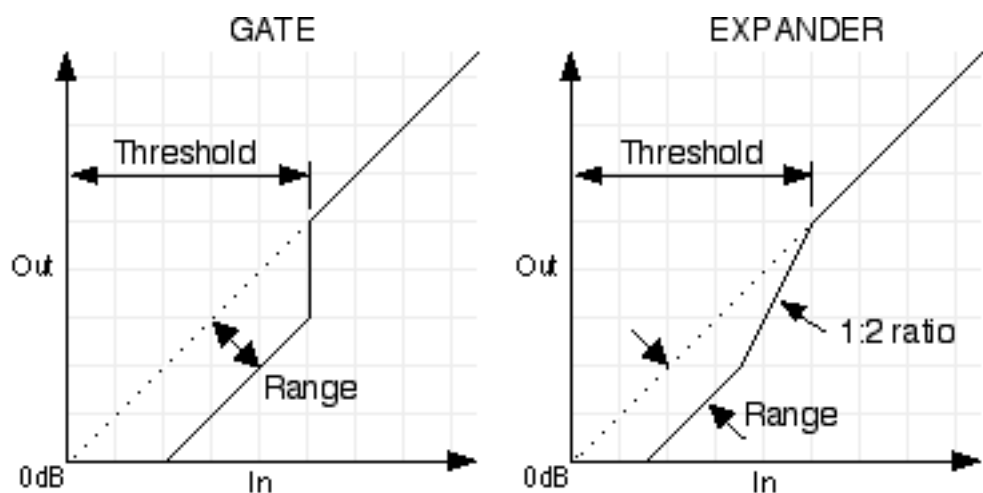

Figure 47. The Neve 88RS Gate/Expander diagram

### Gate/Exp Enable (G/E)



This button activates the gate/expander module. The module is active when the button is gray and the green indicator illuminates.

You can use this button to compare the gate/expander settings to that of the original signal, or to bypass the module altogether. UAD DSP load is reduced when this module is inactive.

### Gate/Exp Hysteresis (HYST)



The Hysteresis knob sets the difference in threshold for signals that are either rising or falling in level. Signals that are rising in level are passed when the level reaches the threshold value plus the hysteresis value. Signals that are falling in level are not passed at the lower threshold level. Up to 25dB of hysteresis is available. See [Figure 48 on page 172](#).

Hysteresis makes the gate less susceptible to “stuttering” by making the threshold value dependent upon whether the gate is off or on. Raising the threshold for rising signal levels prevents noise from turning the gate on, while allowing a lower threshold for falling levels. This prevents reverb tails from being prematurely gated. For example, if the threshold is set at  $-50$  and the hysteresis is set at 10, the level would have to rise above  $-40$ dB before the signals pass, and the gate would remain open until the level falls below  $-50$ dB.

This control also activates expander mode. Rotating Hysteresis fully counter-clockwise switches the gate off and the 1:2 downward expander on.

**Note:** Expander mode can also be activated by clicking the EXP label text near the knob. When EXP is clicked again, the knob returns to the previous value in gate mode.

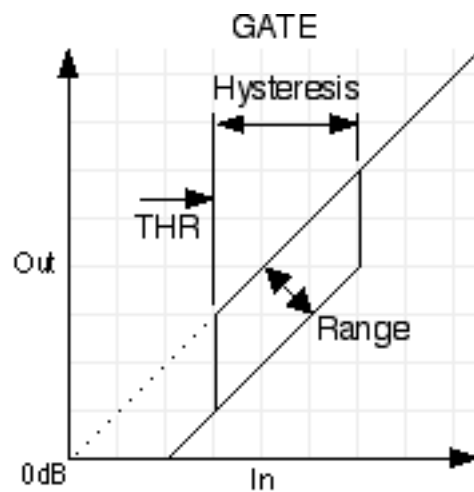

Figure 48. Hysteresis in the Neve 88RS Gate

### Gate/Exp Threshold (THR)



Threshold defines the input level at which expansion or gating occurs. Any signals below this level are processed. Signals above the threshold are unaffected.

The available range is  $-25\text{dB}$  to  $+15\text{dB}$ . A range of  $-25\text{dB}$  to  $-65\text{dB}$  is available when the  $-40\text{dB}$  switch is engaged (see “Gate/Exp Threshold  $-40\text{dB}$ ” on page 173).

In typical use it's best to set the threshold value to just above the noise floor of the desired signal (so the noise doesn't pass when the desired signal is not present), but below the desired signal level (so the signal passes when present).

### Gate/Exp Threshold $-40\text{dB}$



The  $-40\text{dB}$  button increases the sensitivity of the gate and expander by lowering the range of the available threshold values. When  $-40\text{dB}$  mode is active, the threshold range is  $-25\text{dB}$  to  $-65\text{dB}$ . When  $-40$  is inactive, the threshold range is  $-25\text{dB}$  to  $+15\text{dB}$ .

To activate  $-40\text{dB}$  mode, click the “pull  $-40$ ” label text or the red indicator just below the Threshold control.  $-40\text{dB}$  mode is active when the red indicator illuminates.

### Gate/Exp Range (RGE)



Range (RGE) controls the difference in gain between the gated/expanded and non-gated/expanded signal. Higher values increase the attenuation of signals below the threshold. When set to zero, no gating or expansion occurs. The available range is  $0\text{dB}$  to  $-60\text{dB}$ .

### Gate/Exp Fast



The Fast mode switch defines the gate/expander attack time, which is the duration between the input signal reaching the threshold and processing being applied. Two times are available:  $500$  microseconds (when Fast is off) and  $50$  microseconds (when Fast is active).

To activate Fast mode, click the “pull FAST” label text or the red indicator just below the Range (RGE) control. Fast mode is active when the red indicator illuminates.

### Gate/Exp Release (REL)



Release sets the amount of time it takes for processing to engage once the input signal drops below the threshold level. The available range is  $10$  milliseconds to  $3$  seconds.

Slower release times can smooth the transition that occurs when the signal dips below the threshold, which is especially useful for material with frequent peaks.

**Note:** Fast release times are typically only suitable for certain types of percussion and other instruments with very fast decays. Using fast settings on other sources may produce undesirable results.

### Gate/Exp Meter



This meter displays the amount of gain attenuation (downward expansion) occurring in the gate/expander module.

### Limiting/Compressor

The limiter/compressor module offers a continuously variable ratio between 1:1 (no compression) and infinity:1 (limiting). Signals above the threshold are attenuated according to the ratio (RAT) value. Two attack speeds and continuously variable release times are available, along with a pleasing automatic triple time-constant program-dependent release mode (auto mode has a three-stage release). A makeup gain control and a hard/soft knee setting are also available in the module.

From the AMS-Neve 88RS User Manual: “Anti pumping and breathing circuitry allows the unit to operate on the source musically whilst retaining absolute control over the dynamic range.”

The 88RS compressor has another nifty property: Two thresholds. When the signal falls below the threshold, the compressor is releasing. But, if the signal falls below a second (non-adjustable) threshold, which is roughly 40 dB below the adjustable threshold value, then the release slows down drastically. This acts as a “silence detector.” The concept is that if there is a quiet signal, then the compressor should release to reduce the dynamic range. But if there is a sudden onset of silence, it is likely that, when the signal returns, it will be at about the same level as the region before the silence. So in that case, the compressor doesn't release quickly.

An example: When compressing a snare track with a standard compressor, if the snare hits are sparse, the compressor will release between each hit, so that each hit has a squashed sound. With the 88R compressor, distortion will be reduced, because the compressor will not come out of compression as much between the snare hits. The compressor will still release somewhat during the snare hits, however.

**Note:** For additional information, see “Compressor Basics” on page 109.

### L/C Enable (L/C)



This button activates the limiter/compressor module. The module is active when the button is gray and the green indicator illuminates.

You can use this button to compare the limiter/compressor settings to that of the original signal, or to bypass the module altogether. UAD DSP load is reduced when this module is inactive.

### L/C Gain



The Gain control adjusts the output level of the limiter/compressor module. The available range is 0dB to 30dB.

Generally speaking, adjust this makeup gain control after the desired amount of processing is achieved with the Threshold control. The Gain control does not affect the amount of processing.

### L/C Hard Knee (HN)



Normally, the limiter and compressor operate with soft knee characteristics. This switch gives the limiter and compressor a hard knee instead.

To activate Hard Knee mode, click the “pull HN” label text or the red indicator just below the Gain control. Hard Knee mode is active when the red indicator illuminates.

### L/C Threshold



Threshold defines the input level at which limiting or compression begins. Signals that exceed this level are processed. Signals below the threshold are unaffected.

The available range is +20dB to –10dB. A range of 0dB to –30dB is available when the –20dB switch is engaged (see “L/C Threshold –20dB” on page 176).

**Note:** As the Threshold control is increased and more processing occurs, output level is typically reduced. Adjust the Gain control to modify the output of the module to compensate if desired.

### L/C Threshold -20dB

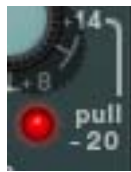

The -20dB switch increases the sensitivity of the limiter/compressor by lowering the range of the available threshold values. When -20dB mode is active, the threshold range is 0dB to -30dB. When -20 is inactive, the threshold range is +20dB to -10dB.

To activate -20dB mode, click the “pull -20” label text or the red indicator just below the Threshold control. -20dB mode is active when the red indicator illuminates.

### L/C Ratio (RAT)



Ratio defines the amount of gain reduction to be processed by the module. For example, a value of 2 (expressed as a 2:1 ratio) reduces the signal by half, with an input signal of 20 dB being reduced to 10 dB.

A value of 1 yields no gain reduction. When the control is at maximum (“lim”), the ratio is effectively infinity to one, yielding the limiting effect. The available range is 1 to infinity.

### L/C Fast



The Fast mode switch defines the attack time (the duration between the input signal reaching the threshold and processing being applied) of the limiter and compressor.

Attack time is program dependent. Two ranges are available: 3 milliseconds to 7 milliseconds (Fast off) and 1 millisecond to 7 milliseconds (Fast active).

To activate Fast mode, click the “pull FAST” label text or the red indicator just below the Ratio (RAT) control. Fast mode is active when the red indicator illuminates.

### L/C Release



Release sets the amount of time it takes for processing to cease once the input signal drops below the threshold level. The available range is 10 milliseconds to 3 seconds, and automatic.

Automatic triple time-constant program dependent release time is activated by turning the release control fully clockwise (to 3s) or by clicking the “AUTO” label text.



Slower release times can smooth the transition that occurs when the signal dips below the threshold, which is especially useful for material with frequent peaks. However, if the release is too long, compression for sections of audio with loud signals may extend to sections of audio with lower signals.

**Note:** *Fast release times are typically only suitable for certain types of percussion and other instruments with very fast decays. Using fast settings on other sources may produce undesirable results.*

## L/C Meter



This meter displays the amount of gain attenuation occurring in the limiter/compressor module.

## Equalizer

The UAD Neve 88RS “Formant Spectrum Equaliser” (AMS-Neve's descriptor) is divided into four frequency bands (see [Figure 49 on page 178](#)): High Frequency (HF), High Midrange Frequency (HMF), Low Midrange Frequency (LMF), and Low Frequency (LF). The high and low bands can be switched into shelving and/or High-Q modes. The two midrange bands are fully parametric. The EQ module can be disabled altogether.

When the high frequency (HF) and/or low frequency (LF) band is in shelf mode, the band gain affects the band frequency. As gain is increased, the shelf frequency more closely matches the knob value. As gain is reduced however, the low shelving frequency moves higher, and the high shelving frequency moves lower.

With the UAD Neve 88RS EQ, the Q value and range is dependent on the gain setting of the band. With any non-zero gain setting, the Q will be calculated in real-time for that band. But if the band gain is zero, Q will always display zero.

“The unique sound of AMS Neve equalisers is the result of years of research and extensive studio experience.”

## 88RS EQ Band Layout

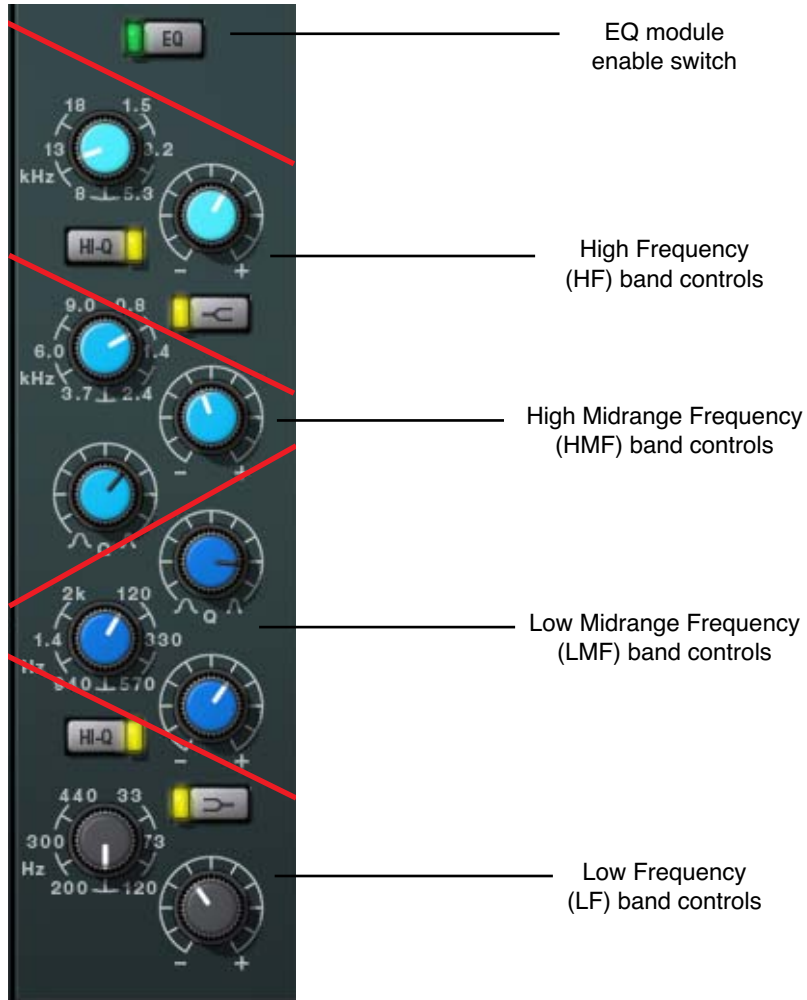
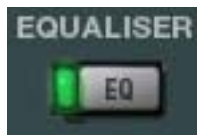

Figure 49. Neve 88RS EQ Controls Layout

### EQ Enable (EQ)



This button activates the equalizer module. The module is active when the button is gray and the green indicator illuminates.

You can use this button to compare the equalized signal to the original signal or bypass the EQ altogether. UAD DSP load is reduced when this module is inactive.

### HF Freq



This parameter determines the HF band center frequency to be boosted or attenuated by the band Gain setting. The available range is 1.5kHz to 18kHz.

### HF Gain



This control determines the amount by which the frequency setting for the HF band is boosted or attenuated. The available range is  $\pm 20$  dB.

### HF Hi-Q Enable

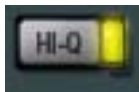

The filter slope of the HF band can be changed with this control. When Hi-Q is off, the Q is 0.7. When Hi-Q is active, the Q is 2. Higher Q values mean the peak (or trough) has steeper slopes.

Hi-Q is active when the button is gray and the yellow indicator illuminates. Hi-Q is off by default.

*Note: Hi-Q has no effect when the band is in shelf mode.*

### HF Shelf Enable

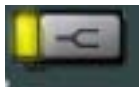

The HF band can be switched from bell mode to shelving mode by clicking the shelf enable button. Shelf mode is active when the button is gray and the yellow indicator illuminates. Shelf is off by default.

### HMF Freq



This control determines the HMF band center frequency to be boosted or attenuated by the HMF Gain setting. The available range is 800Hz to 9kHz.

### HMF Gain



This control determines the amount by which the frequency setting for the HMF band is boosted or attenuated. The available range is  $\pm 20$ dB.

### HMF Q



The Q (bandwidth) control defines the proportion of frequencies surrounding the HMF band center frequency to be affected by the band gain control. The filter slopes get steeper (narrower) as the control is rotated clockwise. The available range is 0.4 to 10.

- LMF Freq** This control determines the LMF band center frequency to be boosted or attenuated by the LMF Gain setting. The available range is 120Hz to 2kHz.
- LMF Gain** This control determines the amount by which the frequency setting for the LMF band is boosted or attenuated. The available range is  $\pm 20$ dB.
- LMF Q** The Q (bandwidth) control defines the proportion of frequencies surrounding the LMF band center frequency to be affected by the band gain control. The filter slopes get steeper (narrower) as the control is rotated clockwise. The available range is 0.4 to 10.
- LF Freq** This parameter determines the LF band center frequency to be boosted or attenuated by the band Gain setting. The available range is 33Hz to 440kHz.
- LF Gain** This control determines the amount by which the frequency setting for the LF band is boosted or attenuated. The available range is  $\pm 20$  dB.
- LF Shelf Enable** The LF band can be switched from bell mode to shelving mode by clicking the shelf enable button. Shelf mode is active when the button is gray and the yellow indicator illuminates. Shelf is off by default.
- LF Hi-Q Enable** The filter slope of the LF band can be switched with this control. When Hi-Q is off, the Q is 0.7. When Hi-Q is active, the Q is 2. Higher Q values mean the peak/trough has steeper slopes.
- Hi-Q is active when the button is gray and the yellow indicator illuminates. Hi-Q is off by default.
- Note:** *Hi-Q has no effect when the band is in shelf mode.*

## Cut Filters

In addition to the four-band EQ, UAD Neve 88RS offers two cut filters, one each for low and high frequencies. The slope of the cut filters is 12dB per octave. Each cut filter has two controls: Cut Enable and Frequency. Both controls are detailed below.

**Note:** *UAD DSP load is not reduced when the cut filters are disabled.*



### Cut Enable



This button activates the cut filter. The cut filter is active when the button is gray and the red indicator illuminates.

### Cut Frequency



This knob determines the cutoff frequency for the cut filter. The available range is 7.5kHz to 18kHz for the high cut filter (lighter blue control), and 31.5Hz to 315Hz for the low cut filter (darker blue control).

## Global

### Sidechain EQ (SC-EQ)

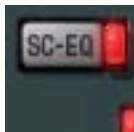

This control enables the UAD Neve 88RS sidechain function. When sidechain is active, signal output from the EQ module is removed from the audio path and is instead routed to control the dynamics module.

Sidechaining is typically used for de-essing and similar frequency-conscious techniques. To listen to the sidechain key, simply disengage SC-EQ to hear the EQ'd signal. The sidechain dynamics/EQ implementations are true stereo when used in a stereo in/stereo out configuration.

***Note:** The EQ module must be active in conjunction with SC-EQ for the sidechain to function (see "EQ Enable (EQ)" on page 178).*

### Pre-Dynamics (P-DYN)



This button re-routes the UAD Neve 88RS signal. Normally, the audio signal is routed from the dynamics module into the EQ module (i.e., the EQ is post-dynamics). When P-DYN is enabled, the EQ module precedes the dynamics module.

Pre-dynamics is active when the button is gray and the red indicator illuminates.

### Phase



The Phase button reverses (inverts) the signal by adding a 180° phase shift. The signal is inverted when the button is gray and the red indicator illuminates. Leave the button inactive (unlit) for normal phase.

## Output



The Output knob controls the signal level that is output from the plug-in. The default value is 0dB. The available range is  $\pm 20$ dB.

## Power

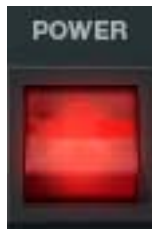

The Power switch determines whether the plug-in is active. This is useful for comparing the processed settings to the original signal or bypassing the plug-in to reduce the UAD DSP load.

Toggle the switch to change the Power state; the switch is illuminated in red when the plug-in is active.

**Note:** You can click-hold the power switch then drag it like a slider to quickly compare the enabled/disabled state.

## WebZine Article

An article about the Neve 88RS console can be found in the “Analog Obsession” article of the Universal Audio May 2007 Webzine (Volume 5, Number 4), published on the internet at:

- <http://www.uaudio.com/webzine/2007/may/index4.html>



*The 88RS at Skywalker Sound in California*

## CHAPTER 20

# CS-1 Channel Strip

### Overview

The CS-1 Channel Strip provides the EX-1 Equalizer and Compressor, DM-1 Delay Modulator, and RS-1 Reflection Engine combined into one plug-in. Individual effects in the CS-1 Channel Strip can be bypassed when not in use to preserve UAD CPU use.

The CS-1 effects can also be accessed individually by using the individual plug-ins. This is useful if you want to use the plug-ins in a different order, or if you want to use multiple instances of the same plug-in (such as a flange routed to a ping-pong delay with the DM-1 plug-in).



Figure 50. The CS-1 Channel Strip plug-in window

## EX-1 Equalizer and Compressor



Figure 51. The EX-1 EQ/Compressor plug-in window

The EX-1 plug-in consists of a five-band parametric EQ and compressor.

### EX-1 Equalizer Controls

The Equalizer portion of the EX-1 is a five-band fully parametric EQ. Each band has its own set of controls. The first two bands can also be enabled to function as low-shelf or high-pass filter. Similarly, the last two bands can be enabled to function as either a high-shelf or low-pass filter.

#### Band Disable Button

Each band can be individually deactivated with the Band Disable button. All bands default to enabled (brighter blue). To disable any band, click the Disable button. The button is darker blue when the band is disabled.

You can use these buttons to compare the band settings to that of the original signal, or to bypass the individual band.



<b>Gain (G) Knob</b>	The Gain control determines the amount by which the frequency setting is boosted or attenuated. The available range is $\pm 18$ dB.
<b>Frequency (fc) Knob</b>	Determines the center frequency to be boosted or attenuated by the Gain setting. The available range is 20 Hertz to 20 kiloHertz. When operating at sample rates less than 44.1 kHz, the maximum frequency will be limited.
<b>Bandwidth (Q) Knob</b>	<p>Sets the proportion of frequencies surrounding the center frequency to be affected. The Bandwidth range is 0.03–32; higher values yield sharper bands.</p> <p>In either of the first two bands, when the Bandwidth value is at minimum the band becomes a low-shelf filter, and at maximum the band becomes a high-pass filter.</p> <p>Similarly, in either of the last two bands, when the Bandwidth value is at minimum the band becomes a high-shelf filter, and at maximum the band becomes a low-pass filter.</p>
<b>Enable/Bypass Switch</b>	Globally enables or disables all bands of the Equalizer. You can use this switch to compare the EQ settings to that of the original signal or bypass the entire EQ section to reduce UAD DSP load.
<b>Output Knob</b>	Adjusts the signal output level of the plug-in. This may be necessary if the signal is dramatically boosted or reduced by the EQ and/or compressor settings.

## EX-1 Compressor Controls

<b>Attack Knob</b>	Sets the amount of time that must elapse, once the input signal reaches the Threshold level, before compression will occur. The faster the Attack, the more rapidly compression is applied to signals above the Threshold. The range is 0.05 milliseconds to 100.00 milliseconds.
<b>Release Knob</b>	Sets the amount of time it takes for compression to cease once the input signal drops below the Threshold level. Slower release times can smooth the transition that occurs when the signal dips below the threshold, especially useful for material with frequent peaks. However, if you set too large of a Release time, compression for sections of audio with loud signals may extend to lengthy sections of audio with lower signals. The range is 25 milliseconds to 2500 milliseconds (2.5 seconds).

<b>Ratio Knob</b>	Determines the amount of gain reduction used by the compression. For example, a value of 2 (expressed as a 2:1 ratio) reduces the signal by half, with an input signal of 20 dB being reduced to 10 dB. A value of 1 yields no compression. Values beyond 10 yield a limiting effect. The range is 1 to Infinity.
<b>Threshold Knob</b>	<p>Sets the threshold level for the compression. Any signals that exceed this level are compressed. Signals below the level are unaffected. A Threshold of 0dB yields no compression. The range is 0dB to -60dB.</p> <p>As the Threshold control is increased and more compression occurs, output level is typically reduced. However, the EX-1 provides an auto-makeup gain function to automatically compensate for reduced levels. Adjust the Output level control if more gain is desired.</p>
<b>Meter Pop-up Menu</b>	Determines whether the VU Meter monitors the Input Level, Output Level, Gain Reduction, or Meter Off. Click the menu above the meter display to select a different metering function.
<b>Enable/Bypass Switch</b>	Enables or disables the Compressor. You can use this switch to compare the compressor settings to that of the original signal or bypass the entire compressor section to reduce UAD DSP load.
<b>Compressor Output Knob</b>	Adjusts the relative output of the plug-in.

## EX-1M Overview

The EX-1M is a monophonic version of EX-1 that enables independent left and right EQ settings in master effects chains and allows Logic Audio users to conserve UAD DSP resources.

EX-1M requires half the processing power compared to that of EX-1 when used on a mono audio track within Logic Audio. Therefore, EX-1M should be used on monophonic audio tracks within Logic whenever possible to conserve UAD resources.

## DM-1 Delay Modulator



Figure 52. The DM-1 Delay Modulator plug-in window

The DM-1 Delay Modulator provides stereo effects for delay, chorus, and flange.

### DM-1 Controls

#### Sync Button

This button puts the plug-in into Tempo Sync mode. See [Chapter 8, “Tempo Sync”](#) for more information.

#### L-Delay Knob

Sets the delay time between the original signal and the delayed signal for the left channel. When the Mode is set to one of the delay settings, the maximum delay is 300 msec. When the Mode is set to one of the chorus or flange settings, the maximum delay is 125 msec.

#### R-Delay Knob

Sets the delay time between the original signal and the delayed signal for the right channel. When the Mode is set to one of the delay settings, the maximum delay is 300 msec. When the Mode is set to one of the chorus or flange settings, the maximum delay is 125 msec.

In the Flanger modes, the L and R delay controls have a slightly different functions than in the chorus modes. The high peak of the flanger is controlled by the settings of the L and R delay controls. The low Peak of the flanger is determined by the setting of the Depth control.

When delay times longer than 300ms are desired, use the DM-1L plug-in instead. DM-1L has a maximum time of 2400ms per channel.

**Mode Pop-up Menu**

Determines the DM-1 effect mode. The available modes are: Chorus, Chorus180, QuadChorus, Flanger1, Flanger2, Dual Delay, and Ping Pong Delay. In addition to reconfiguring the DM-1's settings, the Mode also determines the available parameter ranges for L/R Delay and Depth.

In Chorus mode, both oscillators (or modulating signals) are in phase.

In Chorus 180 mode, both oscillators (the modulating signals) are 180 degrees out of phase.

In QuadChorus mode, both oscillators (the modulating signals) are 90 degrees out of phase.

In Ping Pong delay mode, you will only get a ping-pong effect if you have a mono source feeding the DM-1 on a stereo group track or send effect. On a mono disk track, it works exactly like Dual Delay.

**Rate Knob**

Sets the modulation rate for the delayed signal, expressed in Hertz.

**Depth Knob**

Sets the modulation depth for the delayed signal, expressed as a percentage.

In Dual Delay and Ping Pong Delay modes, adjusting the Depth and Rate controls can offer some very otherworldly sounds.

**LFO Type Pop-up Menu**

Determines the LFO (low frequency oscillator) waveshape and phase used to modulate the delayed signal. The waveshape can be set to triangle or sine, each with a phase value of 0, 90, or 180-degrees.

**Recirculation (RECIR) Knob**

Sets the amount of processed signal fed back into its input. Higher values increase the number of delays and intensity of the processed signal.

Recirculation allows both positive and negative values. The polarity refers to the phase of the delays as compared to the original signal. If Recirculation displays a positive value, all the delays will be in phase with the source. If it displays a negative value, then the phase of the delays flips back and forth between in phase and out of phase.

In the flanger mode, Recir has the potential to make some very interesting sounds. Try turning RECIR fully clockwise or counter-clockwise, and set the delay to very short but different values.

The RECIR units are expressed as a percentage in all Modes except Dual Delay and Ping Pong. In these modes, RECIR values are expressed as T60 time, or the time before the signal drops 60 decibels.

**Damping Knob**

This low pass filter reduces the amount of high frequencies in the signal. Turn down this control to reduce the brightness. Higher values yield a brighter signal. Damping also mimics air absorption, or high frequency rolloff inherent in tape-based delay systems.

**Wet/Dry Mix Knob**

This control determines the balance between the delayed and original signal. Values greater than 50% emphasize the wet signal, and values less than 50% emphasize the dry signal. A value of 50% delivers equal signals. A value of 0% is just the dry signal.

Wet/Dry Mix allows both positive and negative values. The polarity refers to the phase of the delays as compared to the original signal. If a positive value is displayed, then all the delays will be in phase with the source. With a negative value, the delayed signal is flipped 180 degrees out of phase with the source.

**L-Pan Knob**

Sets the stereo position for the left channel, allowing you to adjust the width or balance of the stereo signal. For a mono signal, L-Pan behaves as the level control for the left delay tap.

**R-Pan Knob**

Sets the stereo position for the right channel, allowing you to adjust the width or balance of the stereo signal. For a mono signal, R-Pan behaves as the level control for the right delay tap.

**Enable/Bypass Switch**

Enables or disables the Delay Modulator. You can use this switch to compare the DM-1 settings to that of the original signal or bypass the entire DM-1 section to reduce UAD DSP load.

**Output Knob**

Adjusts the relative output of the plug-in.

**DM-1L**

DM-1L is identical to the DM-1 except that the maximum available delay time per channel is 2400 milliseconds. DM-1L requires significantly more memory resources of the UAD than the DM-1. Therefore, we recommend using the DM-1L only when very long delay times are needed.

## Link Button

This button links the left and right delay knobs so that when you move one delay knob, the other follows. The ratio between the two knobs is maintained.



Figure 53. The DM-1L includes a Link button

## RS-1 Reflection Engine



Figure 54. The RS-1 Reflection Engine plug-in window

## Overview

The RS-1 Reflection Engine simulates a wide range of room shapes, and sizes, to drastically alter the pattern of reflections. While similar to that of the RealVerb Pro plug-in, the RS-1 does not offer the same breadth of features (such as room hybrids, room materials, morphing, and equalization). However, if you do not need the advanced capabilities that RealVerb Pro offers, you can use the RS-1 to achieve excellent room simulations, while also preserving DSP resources on the UAD card.

The Delay control sets the time between the direct signal and the first reflection. The Size parameter controls the spacing between the reflections. The Recir control affects the amount of reflections that are fed back to the input and controls how many repeats you hear.

## RS-1 Controls

**Sync Button** This button puts the plug-in into Tempo Sync mode. See [Chapter 8, “Tempo Sync”](#) for more information.

**Shape Pop-up Menu** Determines the shape of the reverberant space, and the resulting reflective patterns.

Table 10. Available RS-1 Shapes

Cube	Square Plate
Box	Rectangular Plate
Corr	Triangular Plate
Cylinder	Circular Plate
Dome	Echo
Horseshoe	Ping Pong
Fan	Echo 2
Reverse Fan	Fractal
A-Frame	Gate 1
Spring	Gate 2
Dual Spring	Reverse Gate

**Delay Knob** Sets the delay time between the original signal and the onset of the reflections.

**Size Knob** Sets the size of the reverberant space (from 1–99 meters) and defines the spacing of the reflections.

**Delay/Size Settings Interaction** You may notice that when Delay is set to its maximum value (300 ms) and you move the Size control to its maximum value (99), the Delay value is decreased to 16.85. This occurs because the maximum delay time available to the plug-in has been reached. The available delay time is limited and it needs to be divided among the Delay and Size values. Therefore, if the value of the Delay or Size setting is increased towards maximum when the other control is already high, its complementary setting may be reduced.

**Recirculation (RECIR) Knob** Sets the amount of processed signal fed back into its input. Higher values increase the number of reverberations/delays and intensity of the processed signal.

Recirculation allows both positive and negative values. The polarity refers to the phase of the delays as compared to the original signal. If Recirculation displays a positive value, all the delays will be in phase with the source. If it displays a negative value, then the phase of the delays flips back and forth between in phase and out of phase.

**Damping Knob**

This low pass filter reduces the amount of high frequencies in the signal. Turn down this control to reduce the brightness. Higher values yield a brighter signal. Damping also mimics air absorption, or high frequency rolloff inherent in tape-based delay systems.

**Wet/Dry Mix Knob**

This control determines the balance between the delayed and original signal. Values greater than 50% emphasize the wet signal, and values less than 50% emphasize the dry signal.

Wet/Dry Mix allows both positive and negative values. The polarity refers to the phase of the delays as compared to the original signal. If a positive value is displayed, then all the delays will be in phase with the source. With a negative value, the delayed signal is flipped 180 degrees out of phase with the source.

**L-Pan Knob**

Sets the stereo position for the left channel, allowing you to adjust the width or balance of the stereo signal. For a mono signal, set both the L-Pan and R-Pan to the left.

**R-Pan Knob**

Sets the stereo position for the right channel, allowing you to adjust the width or balance of the stereo signal. For a mono signal, set both the L-Pan and R-Pan to the left.

**Enable/Bypass Switch**

Enables or disables the Reflection Engine. You can use this switch to compare the RS-1 settings to that of the original signal or bypass the entire RS-1 section to reduce UAD DSP load.

**Output Knob**

Adjusts the relative output of the plug-in.



# Precision Equalizer

## Overview

The Universal Audio Precision Equalizer™ is a stereo or dual-mono four band EQ and high-pass filter designed primarily for mastering program material. The Precision Equalizer may also be used in recording and mixing where the utmost in EQ quality is required. The Precision Equalizer is based on industry standard analog mastering filters, and uses the classic parametric controls arrangement. The Precision Equalizer utilizes the best from those designs while incorporating features convenient to digital mastering. To preserve the greatest sonic detail and ensure a minimum of artifacts in the upper frequency range, the Precision Equalizer is upsampled to 192khz.

## Precision Equalizer Screenshot



Figure 55. The UAD Precision Equalizer plug-in window

## Precision Equalizer Controls

The easy to use Precision Equalizer features stepped controls throughout for easy recall. Both the left and right channels feature four bands of EQ, grouped in two overlapping pairs. There are two bands for low frequencies (L1 and L2), and two for highs (H1 and H2). There is also a shelving or peak/notch filter available for each band, along with five peak/notch (Q) responses per band. The high-pass filter is a far-reaching 18dB per octave, which enables precise filtering of power-robbing sub-harmonic content, or other creative uses.

The Precision Equalizer also features flexibility in auditioning. There are three separate EQ configurations, allowing selection of two complete sets of stereo parameters or the Dual mode when disparate channel adjustments are necessary. In addition, parameter values can be easily transferred between parameter groups using the Copy buttons.

## Control Grouping



The L and R equalizer sections are independent groups of parameters, each controlling one side (left or right) of the stereo source signal.

The L and R controls are linked except when in Dual mode. In Dual mode, control groups L and R can be independently adjusted.

## Modes



The Mode switches define the operating mode of Precision Equalizer. The currently active mode is indicated by a blue light. Each mode is detailed below.

### Stereo Mode

In Stereo mode, the L and R equalizer sections both control one side of the stereo source signal. The L and R controls are linked in stereo mode.

In stereo mode there are two sets of EQ settings (referred to as A and B), with each set containing the full set of L and R parameter values (the high-pass filter value is global per preset). This feature enables easy switching between two EQ settings for comparison purposes. Both the A and B parameter sets are contained within a single Precision Equalizer preset.

## Dual Mode

In Dual mode (dual-mono mode), the left and right parameters can be independently adjusted so that each side of the stereo signal can have different EQ settings. Note that this mode is infrequently used during mastering because phase, imaging, and level inconsistencies may be induced in the resulting stereo signal.

### Mode Selection

Any of the below methods may be used to modify the Mode value:

- Click the Stereo button to cycle through modes A and B
- Click the Dual button to activate dual-mono mode
- Click the indicator light above each mode
- Click+hold+drag the indicator light above each mode.

## Parameter Copy Buttons



The Parameter Copy buttons provide an easy method for copying parameter values. The behavior of the buttons is determined by the current operating mode of Precision Equalizer.

**Note:** *The values that existed at the destination before copying are lost.*

### Stereo Mode

When in Stereo mode (see “Stereo Mode” on page 194), clicking A > B copies the left AND right parameter values from parameter set A to parameter set B, and clicking the A < B button copies all the values from parameter set B to parameter set A.

This feature is useful when you want to make an EQ change to a stereo signal while maintaining the original values so the two settings can be easily compared.

**Note:** *The high-pass filter parameter is global per preset and is not affected by this control.*

### Parameter Copy in Dual Mode

When in Dual mode, the A and B buttons behave as left and right channel copy buttons. Clicking A > B copies all the values from the left channel parameters to the right channel parameters, and clicking A < B copies all the values from the right channel parameters to the left channel parameters.

## Power Switch



The Power Switch determines whether the plug-in is active. This is useful for comparing the processed settings to that of the original signal, or to bypass the plug-in to reduce the UAD DSP load.

Click the rocker switch to change the Power state. Alternately, you can click the blue UA logo to toggle the Power state.

## Band Controls

Each control set (L and R) has four EQ bands. Two bands are overlapping low frequency bands labeled L1 and L2, and two bands are overlapping high frequency bands labeled H1 and H2.

Each of the four bands has a control for bandwidth, enable, frequency, and gain. All four of the EQ bands can be used in parametric or shelf mode. The controls are exactly the same for each band; only the available frequency values differ.

## Bandwidth Knob

The Bandwidth (Q) knob defines the proportion of frequencies surrounding the band center frequency to be affected by the band gain control.

The numbers represent the filter slope in dB per octave. The available selections are 4, 6, 9, 14, 20, and Shelf.

When set to Shelf on the L1 and L2 bands, the band becomes a low shelving filter. When set to Shelf on the H1 and H2 bands, the band becomes a high shelving filter.

## Band Enable Button



Each band can be individually engaged with the Enable button. All bands default to disabled. When a band is enabled, the button glows blue. To enable a band, click the Enable button or move the band Gain knob.

You can use these buttons to compare the band settings to that of the original signal, or to bypass the individual band. UAD DSP usage is slightly decreased when a band is disabled.

## Frequency Knob

The Frequency knob determines the center frequency of the filter band to be boosted or attenuated by the band Gain setting.

This knob is stepped with 41 values for easy reproducibility during mastering. To double the resolution of the available knob values (for fine control), press the shift key on the computer keyboard while adjusting the knob. This increased 2x frequency resolution (within the available range) can also be specified using text entry, parameter automation, or 'controls' mode. The available values for each of the four bands is the same in both parametric and shelf modes, and are listed in [Table 11](#) below.

**Note:** *Not all host applications support automation and/or controls mode.*

Table 11. Precision Equalizer Band Frequency Ranges

Low Frequencies (L1 and L2)	19 – 572 Hertz
High Frequencies (H1 and H2)	617 – 27k Hertz

## Gain Knob

The Gain knob determines the amount by which the frequency setting for the band is boosted or attenuated. The available Gain values are listed in [Table 12](#) below.

Table 12. Precision Equalizer band gain values

0.0dB	±2.0dB	±5.0dB
±0.5dB	±2.5dB	±6.0dB
±1.0dB	±3.0dB	±8.0dB
±1.5dB	±4.0dB	

## High-Pass Filter



The high-pass filter is useful for reducing low frequency content. It is a global filter; it always affects both left and right channels, regardless of the active mode. See [Table 13](#) below for available settings.

Table 13. Precision Equalizer high-pass filter frequencies

Off (disabled)	40Hz
10Hz	60Hz
20Hz	80Hz
30Hz	100Hz

## Precision Equalizer Latency

The Precision Equalizer uses an internal sample rate of 192kHz to facilitate its amazing sonic quality. This upsampling results in a slightly larger latency than other UAD plug-ins. You may enter a value in the “Samples” parameter in DelayComp or TrackAdv to compensate. See [“Compensating Upsampled Plug-Ins” on page 95](#) for more information.

**Note:** *Compensating for Precision Equalizer is not required if the host application supports full plug-in delay compensation throughout the signal path, or when it is used only on the outputs. See [“Host PDC Implementation” on page 88](#).*

## CHAPTER 22

# Cambridge EQ

### Overview

The UAD Cambridge EQ plug-in is a mastering-quality, no-compromise equalizer that enables powerful tonal shaping of any audio source. Its algorithm was modeled from various high-end analog filters, providing a sonically rich foundation for timbral manipulation. Special attention was given to the handling of higher frequencies, resulting in a much smoother and more satisfying high-end response than is found in most digital filters.

Cambridge EQ is highly flexible, offering a broad spectrum of options facilitating surgical precision and delivering superior aural results in every application. This may be the most satisfying, full-featured equalizer in your arsenal of creative tools.

### Cambridge EQ Screenshot



Figure 56. The UAD Cambridge EQ plug-in window

## Cambridge EQ Controls

Each feature of the Cambridge EQ interface is detailed below.

### Response Curve Display

The Response Curve Display plots the frequency response of the current Cambridge EQ settings. It provides instant visual feedback of how audio is being processed by the equalizer.

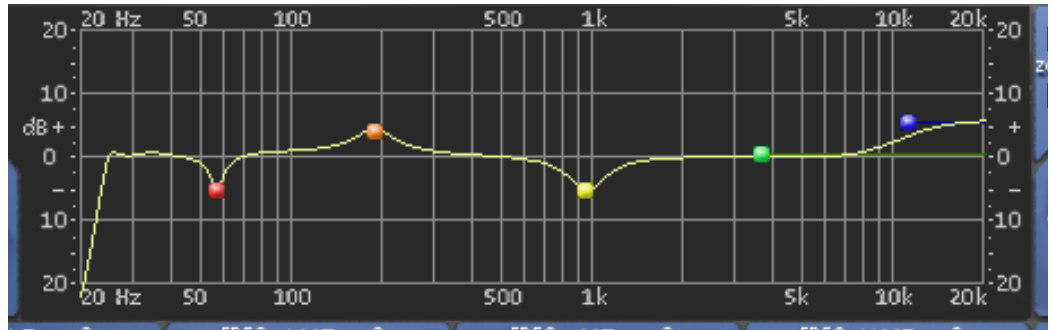

Figure 57. Cambridge EQ Response Curve display

The entire audio spectrum from 20Hz to 20KHz is displayed along the horizontal axis. Gain and attenuation of frequencies (up to +/- 40dB) are displayed along the vertical axis. The vertical resolution of this display can be modified with the Zoom buttons.

### Response Curve Color

The color of the response curve depends on the value of the A/B Selector control. When A is active, the curve is yellow. When B is active, the curve is green (see [“A/B Selector Button”](#) on page 202). When Cambridge EQ is disabled, the response curve is grey.



## Zoom Buttons

The vertical scale of the Curve Display can be increased or reduced with the Zoom buttons. This function allows the resolution of the Curve Display to be changed for enhanced visual feedback when very small or very large amounts of boost or cut are applied. Four vertical ranges can be selected with the Zoom buttons: +/- 5, 10, 20, and 40dB.

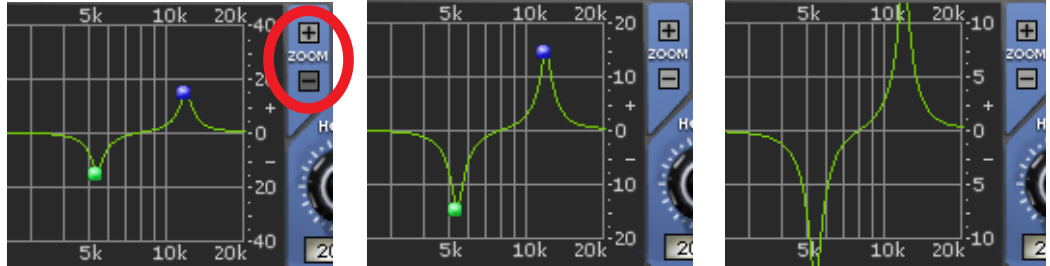

Figure 58. Vertical resolution of the Response Curve can be changed with the Zoom buttons

## Curve Control Bats

There are five control “bats” on the curve display. Each bat is color coded and corresponds to each of the five EQ bands. The position of the bat on the curve display reflects the frequency and gain of its corresponding band, even if the band is disabled.

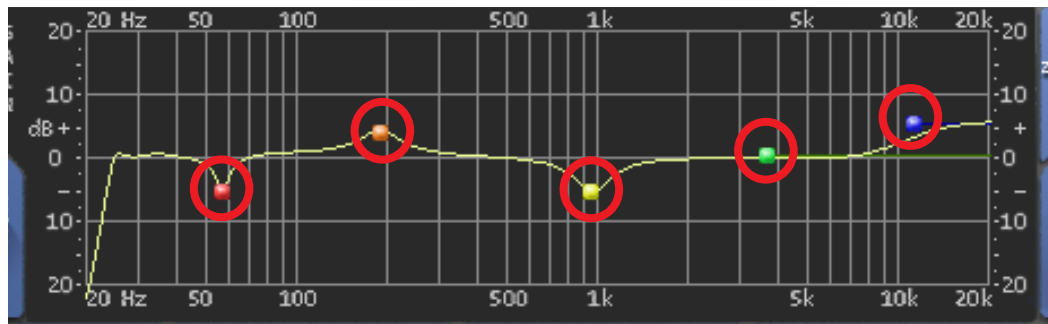

Figure 59. The Curve Control Bats can be used to control EQ band frequency, gain, and Q

The gain and frequency of an EQ band can be modified simultaneously by dragging its bat with the mouse. If a band is disabled when its bat is touched for the first time, the band is enabled.

**Note:** To modify the Q of a band with its bat, hold down the Control key while dragging vertically.

When a band is enabled, the EQ curve usually touches the bat. However, because the EQ curve always displays the actual frequency response of Cambridge EQ, if two bands are close together in frequency and/or at extreme gain values, the bat may not touch the curve itself.

### Master Level Knob



This control adjusts the signal output level of Cambridge EQ. This may be necessary if the signal is dramatically boosted or reduced by the EQ settings. The available range is +/- 20dB.

### A/B Selector Button



The A/B Selector switches between two separate sets of Cambridge EQ plug-in values. This feature enables easy switching between two completely independent EQ curves which can be useful for comparison purposes or for automating radical timbre changes. Both the A and B curves reside within a single Cambridge EQ preset.

Click the A/B Selector button to switch between the two curves. When A is displayed, the button and the EQ response curve is yellow. When B is displayed, the button and the curve is green.

**Note:** To reset the A or B curve to a null (flat) response, control-click the A/B Selector button. The active curve will be nulled.

**Note:** To copy one curve to another, shift-click the button. The active curve will be copied to the inactive curve.

### EQ Enable Button

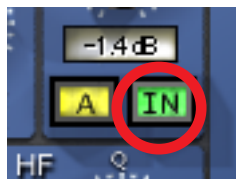

This button enables or disables the Cambridge EQ altogether. You can use this switch to compare the processed settings to that of the original signal, or to bypass the plug-in to reduce UAD DSP load.

## Low Cut / High Cut Filters



The Low Cut and High Cut filters are offered in addition to the five parametric/shelf bands. A wide range of filter types is provided to facilitate tonal creativity. Many filters that are available are represented.

Three controls are offered: Cut Type, Enable, and Frequency. Each control is detailed below.



### Cut Type Menu

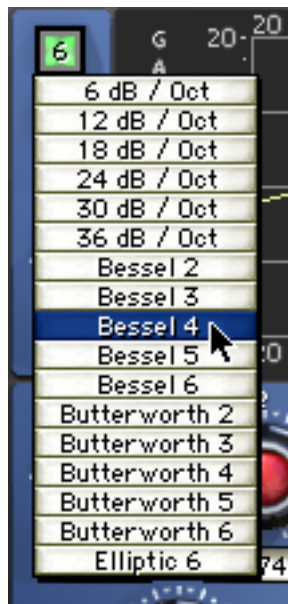

The Cut Type menu determines the sound of the low and high cut filters. To view the Cut Type menu, click and hold the green cut type button.

Four types of responses are provided: Coincident Pole, Bessel, Butterworth, and Elliptic. The numbers represent the filter order, i.e. Bessel 4 is a fourth-order filter. Each offers a different sound. To select a new cut response, drag to the desired response and release.

The responses are more gentle on filters with lower numbers, and get steeper and more aggressive as the numbers increase. The coincident-pole filters are first-order filters cascaded in series and offer gentle slopes. Bessel filters are popular because of their smooth phase characteristic with decent rejection. Butterworth filters offer even stronger rejection. The Elliptic setting is about as “brick wall” as you can get. Generally speaking, more phase shifting occurs as the response gets steeper.

**Note:** UAD DSP usage does increase some as the filters get stronger.

### Cut Enable Button

This button activates the cut filters. The filters are enabled when the “In” button is green. UAD DSP usage is slightly reduced when the cut filters are disabled.

### Cut Frequency Knob

This knob determines the cutoff frequency for the Cut filters. The available range is from 20Hz-5kHz for the low cut filter, and 20Hz-20kHz for the high cut filter.

## EQ Bands

All five of the EQ bands can be used in parametric or shelf mode. Each band has identical controls, the only difference is the frequency range values.

The function of the controls is similar in both parametric and shelf modes. The two modes are described separately (see “Parametric EQ” on page 205 and “Shelf EQ” on page 208).



Figure 60. The EQ Band controls

### Enable Button

Each band can be individually engaged with the Enable button. The button is green when the band is enabled. All bands default to disabled. To enable any band, click the Enable button.

You can use these buttons to compare the band settings to that of the original signal, or to bypass the individual band. UAD DSP usage is slightly decreased when a band is disabled.

### Frequency Knob

This parameter determines the center frequency to be boosted or attenuated by the Gain setting. The available range for each of the five bands is the same for both parametric and shelf modes. The ranges are shown in Table 14.

Table 14. Available ranges for the Band Frequency parameter

Low Frequencies (LF)	20-400Hz
Low-Mid Frequencies ((LMF)	30-600Hz
Mid Frequencies (MF)	100-6kHz
High-Mid Frequencies (HMF)	900-18kHz
High Frequencies (HF)	2k-20kHz

**Note:** When operating at sample rates less than 44.1kHz, the maximum frequency will be limited.

**Gain Knob** This parameter determines the amount by which the frequency setting for the band is boosted or attenuated. The available range is  $\pm 20$  dB.

**Q (Bandwidth) Knob** The behavior of the Q parameter varies depending on the band mode and the gain. For this reason Q is detailed separately in the parametric and shelf mode sections (see [“Parametric Q” on page 205](#) and [“Shelf Q” on page 208](#)).

## Parametric EQ

A band is in parametric mode when shelf mode is disabled (see [“Shelf Enable Button” on page 208](#)). Three types of parametric EQ are available, as determined by the Parametric Type selector.

### Parametric Type Selector



The Parametric Type selector changes the response of the band controls to reflect the behavior of various analog equalizers. It is a global control for all 5 bands, and has no effect on the low and high cut filters. Click the Parametric Type display to rotate between Types I, II, and III.

The filter algorithm is the same in all three parametric types. The difference is in the dependency between the gain and Q parameters. Each parametric type has its own response characteristics.

In Type I mode, the Q remains constant regardless of the gain setting. In Type II mode, the Q increases as gain is boosted, but remains constant as gain is attenuated. In Type III mode, the Q increases as gain is boosted and attenuated. See [Figure 61](#), [Figure 62](#), and [Figure 63](#).

### Parametric Q

The Q (bandwidth) knob sets the proportion of frequencies surrounding the center frequency to be affected by the gain control. The Q range is 0.25–16; higher values yield sharper slopes.

Note that the Q numeric value in relation to its knob position is warped (i.e. not linear) and varies according to the parametric type.

## Type I

When set to Type I, the bandwidth remains at a fixed Q regardless of the gain setting for the band; there is no Q/Gain interdependency. In addition, there is a finer resolution of the Q knob in the middle of its range. This makes it easier to achieve subtle bandwidth changes. Note that the Q value and knob positions do not change as the gain is modified. See [Figure 61](#).

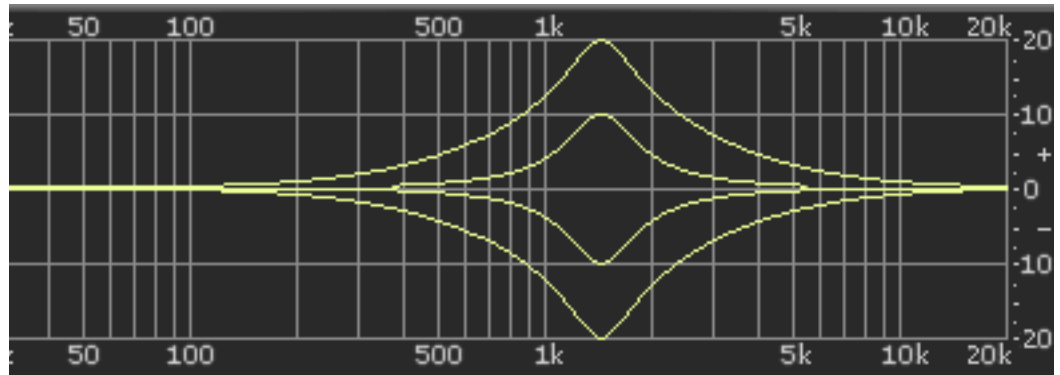

Figure 61. Parametric Type I response

## Type II

When set to Type II, there is a Q/Gain dependency on boost. The bandwidth increases continuously as the gain is boosted, but not when attenuated. The Q knob position determines the maximum Q at full gain.

Filter bandwidth is broader at lower boost settings and narrower at higher boost settings. This can produce a smoother, more natural response when boosting filter gain.

Note that the Q value increases as gain is boosted but the knob position does not change. The Q value is approached as gain increases, and reaches the knob position at maximum gain. See [Figure 62](#).

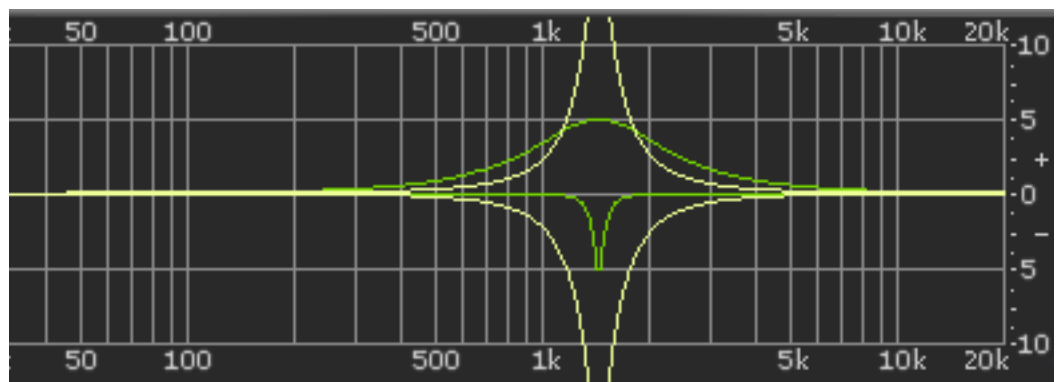

Figure 62. Parametric Type II response

### Type III

When set to Type III, there is a Q/Gain dependency on boost and attenuation. The bandwidth increases continuously as the gain is boosted and attenuated. The Q knob position determines the maximum Q at full gain.

Filter bandwidth is broader at lower gain settings and narrower at higher gain settings. This can produce a smoother, more natural response when adjusting filter gain.

Note that the Q value increases as gain is increased but the knob position does not change. The Q value is approached as gain increases, and reaches the knob position at maximum gain. See [Figure 63](#).

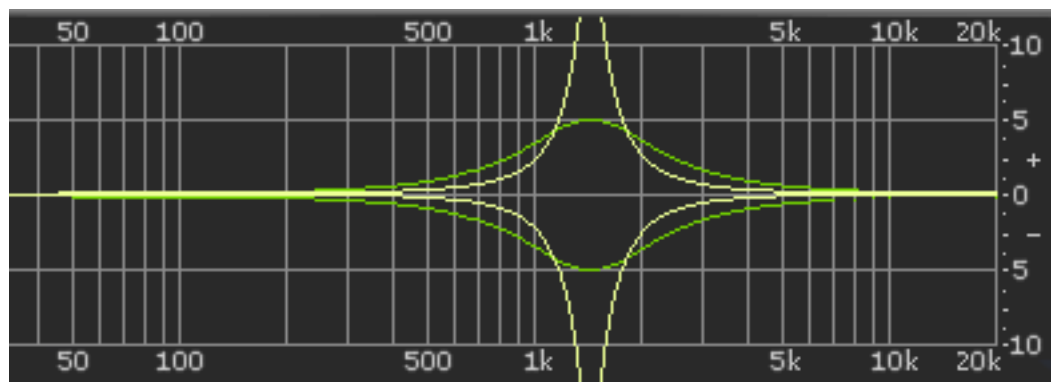

Figure 63. Parametric Type III response

## Shelf EQ

### Shelf Enable Button



Each band can be switched from parametric mode to shelf mode by clicking the shelf enable button. The button is off by default. To enable shelving on any band, click the shelf button.

The button is green when shelving is enabled. Additionally, the control bar associated with the band has a horizontal shelf indicator line in the response curve display (see [Figure 65 on page 209](#)) when shelf mode is active.

### Shelf Type Button



When a band is in shelf mode and its Q is above the minimum value, a resonant peak occurs in the filter response. The Shelf Type button affects where this resonant peak occurs in relation to the shelf frequency.

Its purpose is to emulate the response curves of classic high-end analog mixing consoles. It's yet another tool to help you find the exact sound you are looking for.

The Shelf Type button places the resonant peak at (A) the edge of the stopband ([Figure 64 on page 209](#)), (B) the edge of the passband ([Figure 65](#)), or (C) at the edge of the stopband and the passband ([Figure 66](#)).

### Shelf Q

When a band is in shelf mode, the Q knob sets the resonance of the band. The range of the Q knob is 0-100% when in shelf mode.

**Note:** When a band is in shelf mode, the Gain setting will affect the Q of the band.

When the Q is at its minimum value, there is no resonant peak. The resonance increases and becomes more prominent as the Q is increased. Therefore, for the shelf type to have any effect the Q must be above its minimum value.

**Note:** In order for this button to have any effect, the band must be in shelving mode, some gain must be applied, and the Q must be above its minimum value.



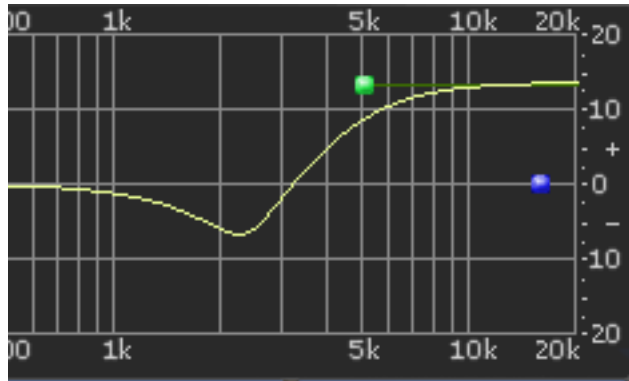

Figure 64. Shelf Type A

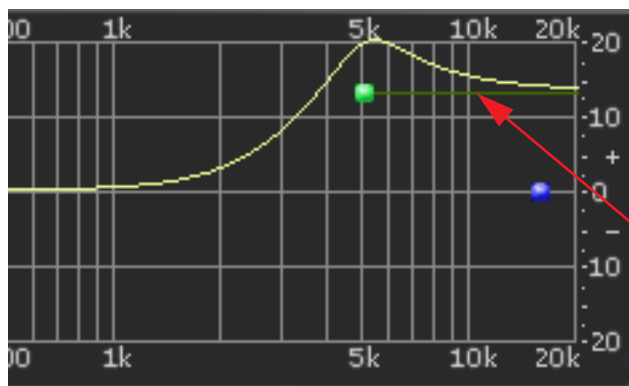

Figure 65. Shelf Type B

Shelf Mode Indicator Line

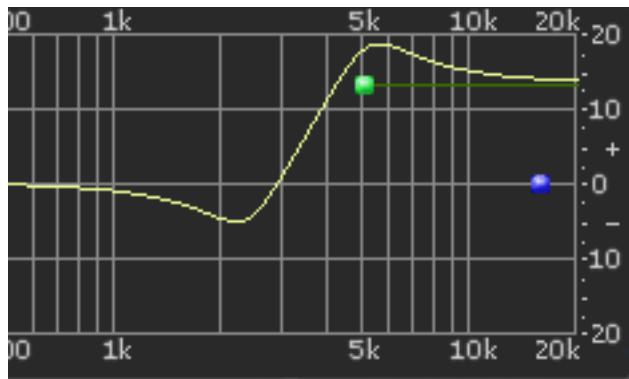

Figure 66. Shelf Type C

## CHAPTER 23

# Pultec and Pultec-Pro

### Overview

The Pultec EQP-1A Program Equalizer and Pultec MEQ-5 plug-ins are faithful electronic reproductions of the classic hardware equalizers. Our DSP wizards have ensured that every revered sonic nuance of these vintage processors are faithfully maintained.

#### **UAD Pultec and UAD Pultec-Pro**

The UAD Pultec plug-in is the EQP-1A Program Equalizer that was introduced in version 2.2 to much acclaim. UAD Pultec-Pro was introduced in version 3.5, and includes both the EQP-1A and MEQ-5 modules. The EQP-1A is identical in UAD Pultec and UAD Pultec-Pro.

In designing the Pultec equalizer plug-ins, we performed detailed analyses of the signal path and equalization characteristics of selected well-maintained, in-spec Pultec equalizers used regularly in professional studios. A “golden unit” was selected, and the resulting model reproduces the measured equalization and signal path characteristics to within a fraction of a dB mean error for all knob settings.

All of the unique features of the original Pultec EQ’s are included in the plug-ins, including the separate boost and attenuation controls, the smooth, sweet top end, and the ability to dial in seemingly dangerous amounts of boost without getting into trouble. All front panel controls are included, and all of the knob tapers are accurately modeled. The Pultec has long been a choice of recording and mastering engineers for its ability to bring out individual frequency ranges without significantly altering other frequencies. In addition, the Pultec is one of those magical pieces of gear that makes audio program sound better just by passing through it. The sophisticated modeling technology used in the Pultec plug-ins captures both of these key attributes.

**Note:** *The Pultec and Pultec-Pro plug-ins always operates at a high internal sample rate for maximum accuracy. Therefore, the UAD DSP load does not increase even when processing audio at the highest sample rates.*

## Pultec Latency

The Pultec and Pultec-Pro plug-ins introduce an additional 13 samples of delay due to upsampling when the session sample rate is below 100kHz. This additional latency does not occur at sample rates above 100kHz. You may enter a value of 13 in the “Samples” parameter in DelayComp or TrackAdv to compensate. See “Compensating Upsampled Plug-Ins” on page 95 for more information.

**Note:** Compensating for Pultec and Pultec-Pro is not required if the host application supports full plug-in delay compensation throughout the signal path, or when it is used on outputs. See “Host PDC Implementation” on page 88.

## Pultec EQP-1A Screenshot



Figure 67. The Pultec EQP-1A Program Equalizer plug-in window

## Pultec EQP-1A Controls

The EQP-1A can control three frequency ranges simultaneously, using three groups of interacting parameters.

The first group controls the low frequencies and has three controls: boost, attenuation, and frequency select. The second group controls the high frequencies and has three controls: boost, bandwidth, and frequency select. The third group also controls the highs and has two controls: attenuation amount and frequency select.

The placement and grouping of the sections and their related controls are shown in Figure 68 on page 212.



Figure 68. Control grouping within the Pultec EQP-1A

### **In/Out Toggle Switch**

This is a signal bypass control. It allows you to compare the processed and un-processed signal. It does NOT reduce UAD DSP load.

In the hardware EQP-1A, the audio is still slightly colored even when the switch is in the Out position. This is due to the fact that the signal is still passing through its circuitry. Because the plug-in emulates the hardware in every regard, the signal will be slightly processed when this switch is in the Out position. If a true bypass is desired, use the On/Off rotary switch.

### **On/Off Rotary Switch**

This switch enables or disables the EQP-1A altogether. You can use this switch to compare the processed settings to that of the original signal, or to bypass the plug-in to reduce UAD DSP load.

## **Low Frequency Controls**

### **CPS Selector Switch**

This switch determines the frequency of the low shelf portion of the equalizer. CPS is an acronym for Cycles Per Second (Hertz). Four frequencies are available: 20, 30, 60, and 100 Hertz.

### **Boost Knob**

This knob determines the amount of low shelf gain to be applied to the frequency set by the CPS switch.

### **Attenuation Knob**

This knob determines the amount of low shelf cut to be applied to the frequency set by the CPS switch.

**Note:** In the documentation supplied with hardware version of the EQP-1A, it is recommended that both Boost and Attenuation not be applied simultaneously because in theory, they would cancel each other out. In actual use however, the Boost control has slightly higher gain than the Attenuation has cut, and the frequencies they affect are slightly different too. The EQ curve that results when boost and attenuation are simultaneously applied to the low shelf is an additional feature.

## High Frequency Controls

- KCS Selector Switch** This switch determines the frequency of the high boost portion of the equalizer. KCS is an acronym for KiloCycles per Second (kiloHertz). Seven frequencies are available (all in kiloHertz): 3, 4, 5, 8, 10, 12, and 16.
- Bandwidth Knob** This knob sets the proportion of frequencies surrounding the center frequency (determined by the KCS switch) to be affected by the high boost. This is a 'Q' control. Lower values yield a narrower band and effect fewer frequencies.
- Boost Knob** This controls sets the amount of gain for the high frequency portion of the equalizer.

## High Attenuation Controls

- Attenuation Selector Switch** This switch determines the frequency of the high frequency attenuator. Three frequencies are available (all in kiloHertz): 5, 10, and 20.
- Attenuation Knob** This knob determines the amount of high shelf cut to be applied to the frequency set by the Attenuation Selector switch.



## Pultec MEQ-5 Screenshot



Figure 69. The Pultec-Pro MEQ-5 Midrange Equalizer plug-in window

## Pultec MEQ-5 Controls

The MEQ-5 can control three frequency ranges simultaneously, using three groups of interacting parameters.

The first group controls the low -mid frequencies and has two controls: frequency select and boost. The second group controls the mid frequencies and has two controls: frequency select and attenuation. The third group controls high-mids and has two controls: frequency select and boost.

The placement and grouping of the sections and their related controls are shown in [Figure 70](#).



Figure 70. Control grouping within the Pultec-Pro MEQ-5

## On/Off Toggle Switch

This switch disables the MEQ-5 portion of Pultec-Pro. It allows you to compare the processed and unprocessed signal of the MEQ-5. When in the out position, the UAD DSP load is reduced.

In the hardware MEQ-5, the audio is still slightly colored even when the switch is in the Out position and the peak/dip controls are at zero. This is due to the fact that the signal is still passing through its circuitry. Because the plug-in emulates the hardware in every regard, the signal will be slightly processed when this switch is in the In position and the peak/dip controls are at zero. If a true bypass is desired, use the host disable switch.

## Low Peak Controls

**Frequency Selector Switch** This switch determines the frequency of the low-midrange portion of the equalizer. Five frequencies are available: 200Hz, 300Hz, 500Hz, 700Hz, and 1kHz.

**Boost Knob** This knob determines the amount of low-midrange “Peak” (gain) to be applied to the frequency set by the low-midrange frequency selector.

## Dip Controls

**Frequency Selector Switch** This switch determines the frequency of the midrange portion of the equalizer. Eleven frequencies are available: 200Hz, 300Hz, 500Hz, 700Hz, 1kHz, 1.5kHz, 2kHz, 3kHz, 4kHz, 5kHz, and 7kHz.

**Attenuation Knob** This knob determines the amount of midrange “Dip” (cut) to be applied to the frequency set by the midrange frequency selector.

## High Peak Controls

**Frequency Selector Switch** This switch determines the frequency of the high-midrange portion of the equalizer. Five frequencies are available: 1.5kHz, 2kHz, 3kHz, 4kHz, and 5kHz.

**Boost Knob** This knob determines the amount of high-midrange “Peak” (gain) to be applied to the frequency set by the high-mid frequency selector.

## MEQ-5 Response Curves

We’ve included a few frequency response plots that illustrate the response curves of the MEQ-5. All plots were taken at a sample rate of 192kHz.

## Low Peak Response

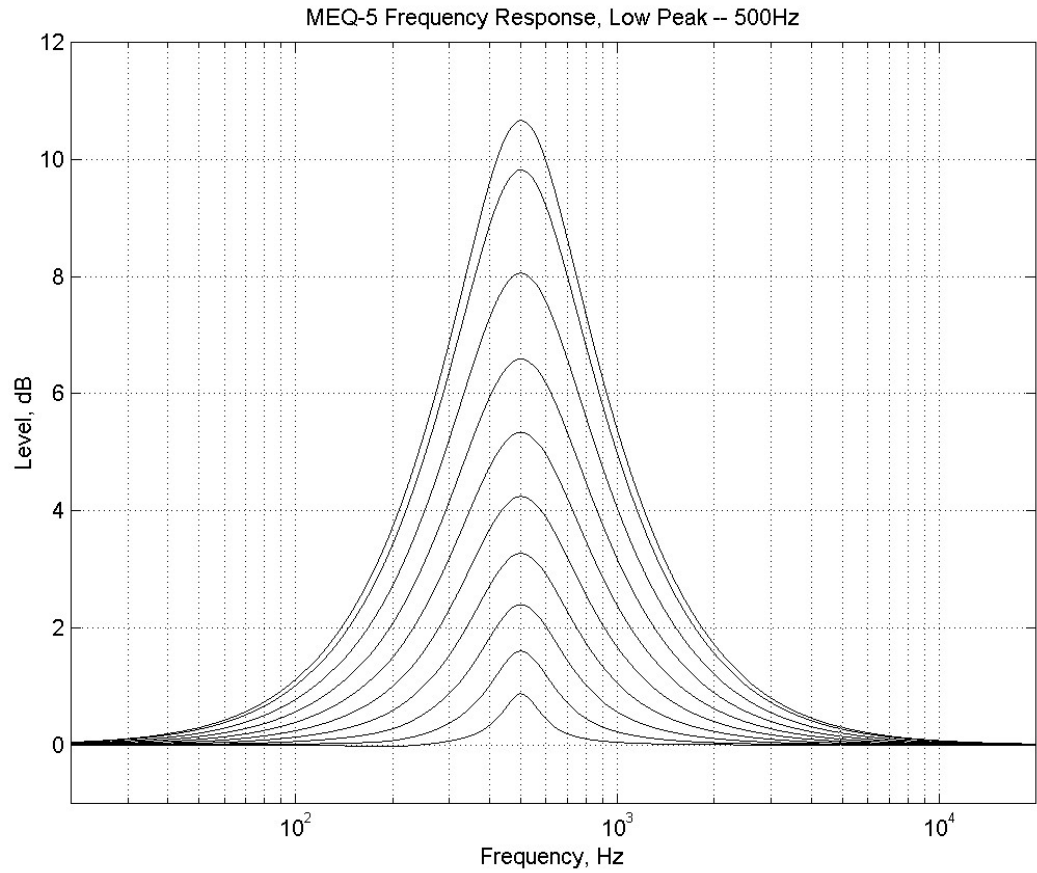

Figure 71. Pultec MEQ-5 Low Peak Response





## Dip Response

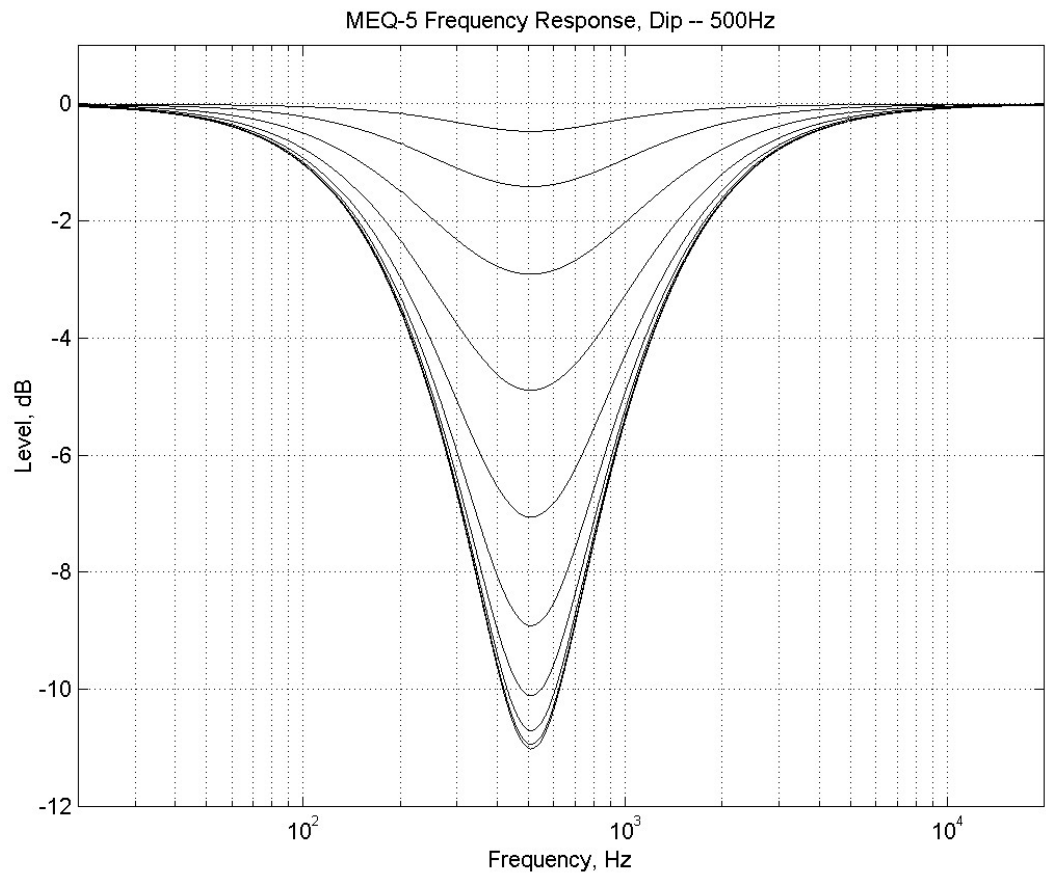

Figure 72. Pultec MEQ-5 Dip Response



## High Peak Response

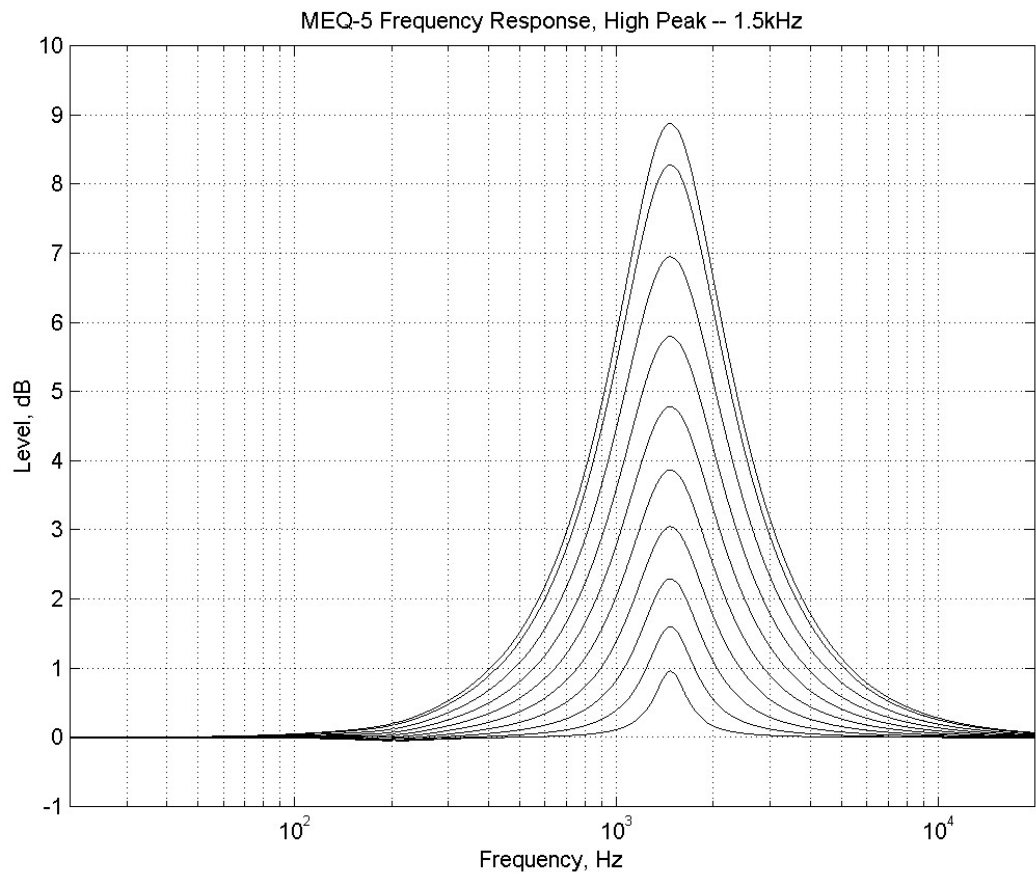

Figure 73. Pultec MEQ-5 High Peak Response

## CHAPTER 24

# Neve 1073 Equalizer

### Overview

Designed by the Rupert Neve company in 1970, perhaps no other studio tool is as ubiquitous or desirable as the Neve 1073 channel module. Without exaggeration, Neve consoles such as the 8014 (where the 1073 originated) have been used on a majority of popular recordings of the late 20th century, and the 1073 easily tops the short-list of audio design masterpieces.

The 1073 is famous for adding an unmistakable sheen and clarity of presence to elements in the mix that is deemed unattainable with any other unit. Modeling the 3-band EQ and high-pass filter in painstaking detail and thoroughness, Universal Audio's Neve 1073 EQ will deliver the same sonic experience expected from its analog cousin with exacting detail. Bundled together come two versions: The 1073 EQ with absolute sonic accuracy, and the 1073SE EQ for high instance counts.

### Neve 1073 Screenshot



Figure 74. The Neve 1073 plug-in window

## Neve 1073 and 1073SE Controls

Each feature of the UAD Neve 1073 and 1073SE interfaces are detailed below.

### Input Gain



The Input Gain control sets the level at the input of the plug-in. The range is from  $-20\text{dB}$  to  $+10\text{dB}$ .

When the Input Gain knob “snaps” to the OFF position, plug-in processing is disabled and UAD DSP usage is reduced.

**Note:** Clicking the OFF screen label toggles between OFF and the previously set Input Gain value. You can also click the Neve logo to toggle between OFF and the previous state.

### High Shelf



The High Shelf knob offers approximately  $\pm 18\text{dB}$  of smooth fixed frequency shelving equalization at  $12\text{kHz}$ .

Rotate the control clockwise to add the famous high-end Neve sheen, or counter-clockwise to reduce the treble response.

### Midrange Band



The midrange band is controlled by dual-concentric knobs, delivering smooth semi-parametric midrange equalization.

The response for this band has a dependence on the bandwidth as the gain is adjusted. At higher center frequencies, the Q goes up, for a more focused peak.

The inner knob controls the band gain, and the outer ring selects the frequency or band disable. These two controls are detailed below.

#### Midrange Gain

The equalization gain for the midrange band is selected with the inner knob of the dual-concentric control. The available range is approximately  $\pm 18\text{dB}$ .

#### Midrange Frequency

The Mid frequency is selected with the outer ring of the dual-concentric knob controls. The ring control can be dragged with the mouse, or click directly on the “silkscreen” text to specify a frequency or disable the Mid band.

**Note:** You can also click the midrange symbol above the knob to cycle through the available values, or shift + click to step back one frequency.

The available midrange center frequencies are 360Hz, 700Hz, 1.6kHz, 3.2kHz, 4.8kHz, 7.2kHz, and OFF. When OFF is specified, the band is disabled. UAD CPU usage is not reduced when the band is OFF.

## Low Band



The low frequency band is controlled by dual-concentric knobs, delivering smooth shelving equalization.

The inner knob controls the band gain, and the outer ring selects the frequency or band disable. These two controls are detailed below.

### Low Gain

The equalization gain for the low band is selected with the inner knob of the dual-concentric control. The available range is approximately  $\pm 15$ dB.

Rotate the control clockwise to boost the selected low band frequency, or counter-clockwise to reduce the bass response.

### Low Frequency

The Low frequency is selected with the outer ring of the dual-concentric knob controls. The ring control can be dragged with the mouse, or click directly on the "silkscreen" text to specify a frequency or disable the Low band.

**Note:** You can also click the low shelf symbol above the knob to cycle through the available values, or shift + click to step back one frequency.

The available low band center frequencies are 35Hz, 60Hz, 110Hz, 220Hz, and OFF. When OFF is specified, the band is disabled. UAD CPU usage is not reduced when OFF.

## Low Cut



This knob specifies the fixed frequency of the Low Cut filter. This filter has an 18dB per octave slope.

The available frequencies are 50Hz, 80Hz, 160Hz, 300Hz, and OFF. When OFF is specified, the low cut filter is disabled. UAD CPU usage is not reduced when OFF.

**Note:** You can also click the low cut symbol above the knob to cycle through the available values, or shift + click to step back one frequency.

## Phase



The Phase switch reverses (inverts) the signal by adding a 180° phase shift. When the switch is in the "In" (darker) position, the phase is reversed. Leave the switch "Out" (lighter) position for normal phase.

## EQL



The equalizer is engaged when the EQL switch is in the "In" (darker) position. To disable the EQ, put the switch in the "Out" (lighter) position. Click the button to toggle the state.

In the hardware 1073, the audio is still slightly colored even when the EQL switch is in the Out position. This is due to the fact that the signal is still passing through its circuitry. Therefore, the signal will be slightly colored when this switch is in the Out position. UAD DSP usage is reduced when the EQ is bypassed with this control.

If a true bypass is desired, use the OFF position of the "Input Gain" on [page 220](#) control.

## Neve 1073SE



Figure 75. The Neve 1073SE plug-in window

## Overview

The UAD Neve 1073SE is derived from the UAD Neve 1073. Its algorithm has been revised in order to provide sonic characteristics very similar to the 1073 but with significantly less DSP usage. It is provided to allow 1073-like sound when DSP resources are limited. Nobody with "golden ears" will say it sounds exactly like the 1073, but it still sounds great and is very usable in most situations.

The 1073SE interface can be differentiated from the 1073 by color and the module name. The 1073SE is black instead of the 1073's dark blue, and the module name on the lower right of the interface panel includes "SE".

## Neve 1073SE Controls

The Neve 1073SE controls are exactly the same as the Neve 1073. Please refer to the Neve 1073 section for Neve 1073SE control descriptions (see [“Neve 1073 and 1073SE Controls”](#) on page 220).

## Neve 1073 Latency

The Neve 1073 (but not the 1073SE) uses an internal upsampling technique to facilitate its amazing sonic quality. This upsampling results in a slightly larger latency than other UAD plug-ins. You may enter a value in the “Samples” parameter in DelayComp or TrackAdv to compensate. The latency, and its compensation, is identical to that of the UAD Precision Equalizer. See [“Compensating Upsampled Plug-Ins”](#) on page 95 for more information.

The Neve 1073SE does not require additional latency compensation because it is not upsampled.

**Note:** *Compensating for Neve 1073 is not required if the host application supports full plug-in delay compensation throughout the signal path, or when it is used only on the outputs. See [“Host PDC Implementation”](#) on page 88.*



Neve® and 1073® are registered trademarks of AMS-Neve, England and are used under license with kind permission from Neve.

## CHAPTER 25

# Neve 1081 Equalizer

### Overview

The Neve 1081 channel module was first produced in 1972 by Neve, and was used to provide the mic/line amp and EQ sections in consoles such as the Neve 8048. Vintage 8048 consoles, with 1081 modules, are still in wide use today at classic facilities such as The Village in Los Angeles, and have been chosen by artists ranging from The Rolling Stones to The Red Hot Chili Peppers.

Universal Audio's Neve 1081 EQ delivers the same sonic experience as its analog cousin with exacting detail. The 1081 EQ also includes a DSP optimized 1081SE EQ for higher instance counts.

### Neve 1081 Screenshot



Figure 76. The Neve 1081 plug-in window



## Neve 1081 and 1081SE Controls

### Overview

The Neve 1081 channel module is a four-band EQ with high and low cut filters. The 1081 features two parametric midrange bands, with “Hi-Q” selections for tighter boosts or cuts. Both the high and low shelf filters have selectable frequencies and may be switched to bell filters. Other features include a  $-20$  to  $+10$  db input gain control, phase reverse, and EQ bypass.

The bands are arranged and grouped as in Figure 77 below. The bands feature dual-concentric controls. For each of the main bands, the inner knob controls the gain while the outer ring controls the frequency. The low and high cut filters are grouped as one knob/ring set, but they are actually two independent filters.

### Band Layout

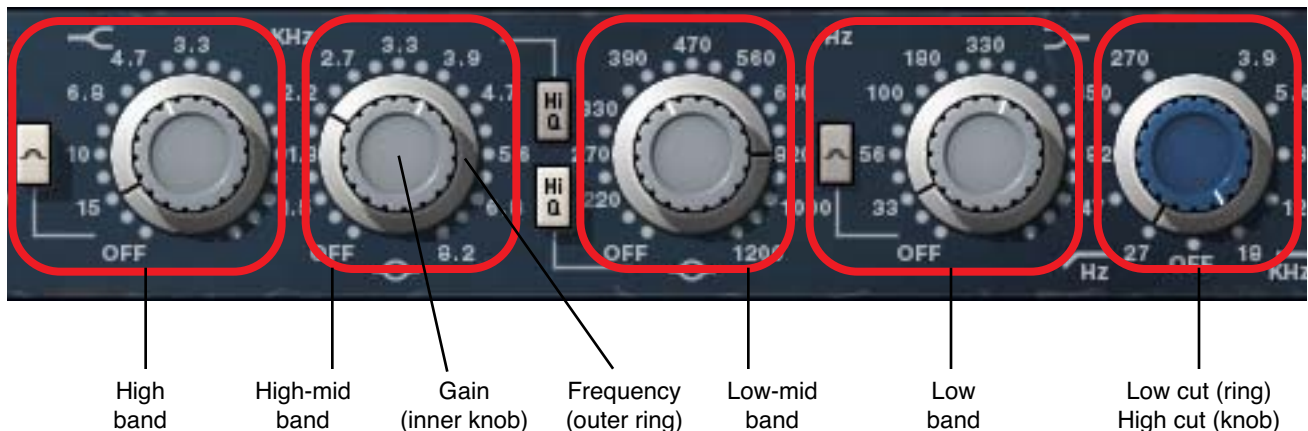

Figure 77. Neve 1081 band control layout

Each feature of the UAD Neve 1081 and 1081SE interfaces are detailed below.

### Input Gain



The Input Gain control sets the level at the input of the plug-in. The range is from  $-20$ dB to  $+10$ dB.

When the Input Gain knob “snaps” to the OFF position, plug-in processing is disabled and UAD DSP usage is reduced.

**Note:** Clicking the OFF screen label toggles between OFF and the previously set Input Gain value. You can also click the Neve logo to toggle between OFF and the previous state.

## High Band



The high band delivers smooth high frequency shelving or peak equalization. The inner knob controls the band gain, and the outer ring selects the frequency or band disable.

### High Gain

The equalization gain for the high band is selected with the inner knob of the dual-concentric control. Rotate the control clockwise to add the famous high-end Neve sheen, or counter-clockwise to reduce the treble response. The available range is approximately  $\pm 18$ dB.

### High Frequency

The high band frequency is selected with the outer ring of the dual-concentric knob controls. The ring control can be dragged with the mouse, or click directly on the “silkscreen” text to specify a frequency or disable the band.

***Note:** You can also click the shelving symbol above the knob to cycle through the available values, or shift + click to step back one frequency.*

The available high band center frequencies are 3.3kHz, 4.7kHz, 6.8kHz, 10kHz, 15kHz, and OFF. When OFF is specified, the band is disabled. UAD CPU usage is not reduced when the band is OFF.

### High Peak Select



The High Peak button switches the high band from a shelving EQ to a peaking EQ. The band is in shelf mode by default; it is in peak mode when the button is “down” (darker).

## High-Mid Band



The high-midrange band delivers smooth high-mid frequency peak equalization with a choice of two bandwidths. The inner knob controls the band gain, and the outer ring selects the frequency or band disable.

### High-Mid Gain

The equalization gain for the high-midrange band is selected with the inner knob of the dual-concentric control. The available range is approximately  $\pm 18$ dB.

### High-Mid Frequency

The high-midrange band frequency is selected with the outer ring of the dual-concentric knob controls. The ring control can be dragged with the mouse, or click directly on the “silkscreen” text to specify a frequency or disable the band.

**Note:** You can also click the midrange symbol below the knob to cycle through the available values, or shift + click to step back one frequency.

The available high-mid band center frequencies are 1.5kHz, 1.8kHz, 2.2kHz, 2.7kHz, 3.3kHz, 3.9kHz, 4.7kHz, 5.6kHz, 6.8kHz, 8.2kHz, and OFF. When OFF is specified, the band is disabled. UAD CPU usage is not reduced when the band is OFF.

### High-Mid Q Select

 The High Q button switches the response of the high-mid band from “normal” to a narrower bandwidth for a sharper EQ curve. The band is in normal mode by default; it’s in high Q mode when the button is “down” (darker).

## Low-Mid Band



The low-midrange band delivers smooth low-mid frequency peak equalization with a choice of two bandwidths. The inner knob controls the band gain, and the outer ring selects the frequency or band disable.

### Low-Mid Gain

The equalization gain for the low-midrange band is selected with the inner knob of the dual-concentric control. The available range is approximately  $\pm 18$ dB.

### Low-Mid Frequency

The low-midrange band frequency is selected with the outer ring of the dual-concentric knob controls. The ring control can be dragged with the mouse, or click directly on the “silkscreen” text to specify a frequency or disable the band.

**Note:** You can also click the midrange symbol below the knob to cycle through the available values, or shift + click to step back one frequency.

The available low-mid band center frequencies are 220Hz, 270Hz, 330Hz, 390Hz, 470Hz, 560Hz, 680Hz, 820Hz, 1000Hz, 1200Hz, and OFF. When OFF is specified, the band is disabled. UAD CPU usage is not reduced when the band is OFF.

#### Low-Mid Q Select



The High Q button switches the response of the low-mid band from “normal” to a narrower bandwidth for a sharper EQ curve. The band is in normal mode by default; it’s in high Q mode when the button is “down” (darker).

### Low Band



The low band delivers smooth low frequency shelving or peak equalization. The inner knob controls the band gain, and the outer ring selects the frequency or band disable.

#### Low Gain

The equalization gain for the low band is selected with the inner knob of the dual-concentric control. The available range is approximately  $\pm 18$ dB.

#### Low Frequency

The low band frequency is selected with the outer ring of the dual-concentric knob controls. The ring control can be dragged with the mouse, or click directly on the “silkscreen” text to specify a frequency or disable the band.

The available low band center frequencies are 33Hz, 56Hz, 100Hz, 180Hz, 330Hz, and OFF. When OFF is specified, the band is disabled. UAD CPU usage is not reduced when the band is OFF.

**Note:** You can also click the shelving symbol above the knob to cycle through the available values, or shift + click to step back one frequency.

#### Low Peak Select



The Low Peak button switches the low band from a shelving EQ to a peaking EQ. The band is in shelf mode by default; it is in peak mode when the button is “down” (darker).

## Cut Filters



The independent low and high cut filters are controlled by the dual-concentric knobs to the right of the low band (see [Figure 77 on page 225](#)). The controls specify the fixed frequency of the cut filter. The cut filters have an 18dB per octave slope.

Click+drag the control to change the value, or click the “silkscreen” frequency values.

**Note:** You can also click the high cut/low cut symbols below the knob to cycle through the available values, or shift + click to step back one frequency.

### High Cut

The inner (blue) dual-concentric knob controls the high cut filter. The available frequencies for the high cut filter are 18kHz, 12kHz, 8.2kHz, 5.6kHz, 3.9kHz, and OFF. When OFF is specified, the high cut filter is disabled. UAD CPU usage is not reduced when OFF.

### Low Cut

The outer (silver) dual-concentric ring controls the low cut filter. The available frequencies for the low cut filter are 27Hz, 47Hz, 82Hz, 150Hz, 270Hz, and OFF. When OFF is specified, the low cut filter is disabled. UAD CPU usage is not reduced when OFF.

## Phase



The Phase switch reverses (inverts) the signal by adding a 180° phase shift. When the switch is in the “In” (lit) position, the phase is reversed. Leave the switch in the “Out” (unlit) position for normal phase.

## EQ Enable



The equalizer is engaged when the EQ switch is in the “In” (lighted) position. To disable the EQ, put the switch in the “Out” (unlit) position. Click the button to toggle the state.

In the hardware 1081, the audio is still slightly colored even when the EQ switch is in the Out position. This is due to the fact that the signal is still passing through its circuitry. Therefore, the signal will be slightly colored when this switch is in the Out position. UAD DSP usage is reduced when the EQ is bypassed with this control.

If a true bypass is desired, use the OFF position of the [“Input Gain” on page 225](#) control.

## Neve 1081SE



Figure 78. The Neve 1081SE plug-in window

### Overview

The UAD Neve 1081SE is derived from the UAD Neve 1081. Its algorithm has been revised in order to provide sonic characteristics very similar to the 1081 but with significantly less DSP usage. It is provided to allow 1081-like sound when DSP resources are limited. Nobody with “golden ears” will say it sounds exactly like the 1081, but it still sounds great and is very usable in most situations.

The 1081SE interface can be differentiated from the 1081 by color and the module name. The 1081SE is black instead of the 1081’s dark blue, and the module name on the lower right of the interface panel includes “SE”.

### Neve 1081SE Controls

The Neve 1081SE controls are exactly the same as the Neve 1081. Please refer to the Neve 1081 section for Neve 1081SE control descriptions (see [“Neve 1081 and 1081SE Controls”](#) on page 225).

### Neve 1081 Latency

The Neve 1081 (but not the 1081SE) uses an internal upsampling technique to facilitate its amazing sonic quality. This upsampling results in a slightly larger latency than other UAD plug-ins. You may enter a value in the “Samples” parameter in DelayComp or TrackAdv to compensate. See [“Compensating Upsampled Plug-Ins”](#) on page 95 for more information.

The Neve 1081SE does not require additional latency compensation because it is not upsampled.

**Note:** *Compensating for Neve 1081 is not required if the host application supports full plug-in delay compensation throughout the signal path, or when it is used only on the outputs. See [“Host PDC Implementation”](#) on page 88.*

Neve® and 1081® are registered trademarks of AMS-Neve, England and are used under license with kind permission from Neve.

## CHAPTER 26

# Helios Type 69 Equalizer

### Overview

Helios consoles were used to record and mix some of the finest rock, pop and reggae classics ever produced. The Beatles, Led Zeppelin, The Rolling Stones, The Who, Roxy Music, Queen, Jimi Hendrix and Bob Marley are just a few that recorded with these amazing wrap-around consoles. Moreover, many great musicians of the era purchased Helios consoles for their personal use. Of all the Helios consoles produced between 1969 and 1979, the original "Type 69" is considered the most musical. Universal Audio modeled the EQ section of the very first Type 69. This console was originally found at Island's Basing Street Studio in London; it now resides with Jason Carmer in Berkeley, California, where it continues to record multi-platinum albums.

### Helios Type 69 Screenshot



Figure 79. The Helios Type 69 plug-in window

## Helios Type 69 Controls

### Overview

The simple yet powerful Helios Type 69 Passive EQ adds a unique sonic texture to the music that passes through it. It can be pushed to its most extreme boost settings while retaining openness and clarity. The Type 69 Passive EQ replicates all the controls of the original hardware. The Treble band is a fixed 10 kHz shelf EQ, while the Bass band functions as a stepped 50 Hz shelf filter (-3,-6,-9,-12,-15 dB) or frequency selectable Peak EQ (60, 100, 200, 300 Hz). The Mid band operates as a frequency selectable Peak or Trough (Notch) EQ with eight frequencies (.7, 1, 1.4, 2, 2.8, 3.5, 4.5, 6 kHz). Other features include Level Adjust, EQ Cut (bypassing the EQ circuit while retaining the native sound of the unit), and Phase Reverse.

### Band Layout

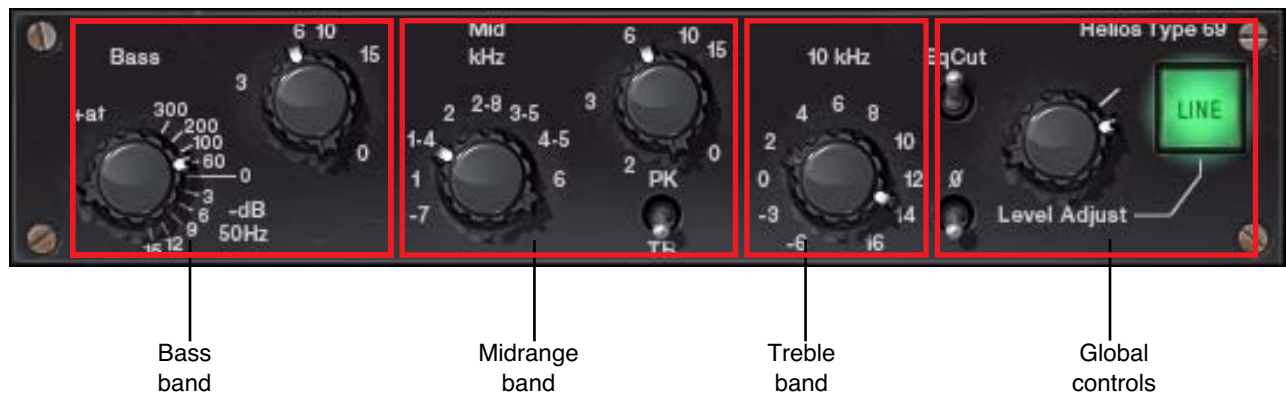

Figure 80. Helios 69 band control layout

The Helios Type 69 design works in such a way that (depending on the settings) entire EQ circuits are switched in and out. In the hardware that often meant audible popping. For the plug-in we use smoothing to reduce these audio spikes, but they may be more audible than with other UAD plug-ins. This is most audible when engaging the Bass or 10 kHz band from OFF to any other setting.

Each feature of the UAD Helios 69 interface is detailed below.



## Bass



The Bass knob has a dual purpose. It specifies the amount of attenuation when the low band is in shelving mode, and specifies the frequency of the low frequency peak filter when the Bass Gain knob is not zero.

When Bass is set to one of the frequency values (60Hz, 100Hz, 200Hz, or 300Hz) the low band is in peak mode. In this mode, the amount of gain (“bass boost”) applied to the specified frequency is determined by the Bass Gain knob.

When this knob is set to one of the decibel values (-3, -6, -9, -12, -15 dB) the low band is in “bass cut” shelving mode with a set frequency of 50Hz.

**Note:** Like the original hardware, simply putting this control on any frequency will yield approximately 3.5dB in gain increase even if the Bass Gain control is set to 0.

## Bass Gain



The Bass Gain knob determines the amount of low band gain to be applied when the Bass knob is in one of the frequency positions. Up to +15dB of boost is available.

**Note:** Bass Gain has no effect when the Bass knob is in shelving mode (when Bass set to one of the dB positions).

## Mid Freq



This control determines the frequency of the midrange band. The following frequencies can be specified: 700Hz, 1kHz, 1.4kHz, 2kHz, 2.8kHz, 3.5kHz, 4.5kHz, and 6kHz.

**Note:** The gain for the mid band is determined by the Mid Gain control. MidFreq has no effect if the Mid Gain control is set to zero.

In the graphic interface of this control, what may appear to be a dash (“-”) actually represents a decimal point. This anomaly mimics the original hardware.

## Mid Gain



This control determines the amount of gain or attenuation to be applied to the mid band. Up to 15dB of boost or cut is available.

The Q (bandwidth) on the midrange band is fairly wide and gentle at low settings, but gets progressively narrower as the gain value is increased.

**Note:** Whether gain or attenuation is applied is determined by the Mid Type control.

### Mid Type



Mid Type specifies whether the midrange band is in Peak or Trough mode. When switched to Peak, the Mid Gain control will boost the midrange. When switched to Trough, Mid Gain will cut the midrange.

**Note:** When using Trough, a 1 dB loss occurs on the overall output of the plug-in. This is normal; the behavior is the same in the original hardware.

### High Shelf Gain



The High Shelf Gain knob offers fixed frequency shelving equalization at 10kHz. This stepped control can cut the treble by -3dB or -6dB, or boost it in 2dB increments up to +16dB.

### EqCut



This switch is an EQ bypass control. It allows you to compare the processed and unprocessed signal. The EQ is active when in the "out" (down) position.

The EQ is bypassed when in the "in" (up) position. EqCut does not reduce UAD DSP load.

In the original Helios hardware, the audio is still slightly colored even when the EQ switch is in the Cut position. This is due to the fact that the signal is still passing through its circuitry. Because the plug-in emulates the hardware in every regard, the signal will be slightly processed when this switch is in the Cut position. If a true bypass is desired, use the Line switch instead.

### Phase

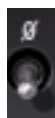

The Phase switch reverses (inverts) the signal by adding a 180° phase shift. When the switch is in the "Inverted" (up) position, the phase is reversed. Leave the switch in the "Normal" (down) position for normal phase.

### Level Adjust



This control adjusts the signal output level of Helios Type 69. This may be necessary if the signal is dramatically boosted or reduced by the EQ settings. The available range is -20dB to +10dB.

## Line



The Line switch determines whether the plug-in is active. This is useful for comparing the processed settings to that of the original signal, or to bypass the plug-in to reduce the UAD DSP load.

Click the switch to toggle the state; the switch is illuminated in green when the plug-in is active.

## Helios 69 Latency

The Helios 69 uses an internal upsampling technique to facilitate its amazing sonic quality. This upsampling results in a slightly larger latency than other UAD plug-ins. You may enter a value in the “Samples” parameter in Delay-Comp or TrackAdv to compensate. See “[Compensating Upsampled Plug-Ins](#)” on page 95 for more information.

**Note:** *Compensating for Helios 69 is not required if the host application supports full plug-in delay compensation throughout the signal path, or when it is used only on the outputs. See “[Host PDC Implementation](#)” on page 88.*

## WebZine Article

An interesting anecdotal article about the Helios console and Type 69 EQ can be found in the “Analog Obsession” article of the Universal Audio March 2007 Webzine (Volume 5, Number 2), published on the internet at:

- <http://www.uaudio.com/webzine/2007/march/index4.html>



*Basing Street—Home of the original Type 69 Helios desk*



*The same desk, now in Berkeley's Morningwood, nearly 40 years later*

## CHAPTER 27

# Roland CE-1

### Overview

The Roland CE-1 Chorus Ensemble is another classic effect faithfully reproduced by our ace modeling engineers. The CE-1 is considered by many to be the definitive chorus effect, renowned for its rich and unique timbres.

Even for the mix engineer, stomp boxes can provide “secret weapon effects” not found any other way. In 1976, BOSS originated the chorus effect pedal, and nobody has come close to matching the CE-1’s captivating chorus sound since then. Its unmistakable warm analog stereo chorus and vibrato have been heard on countless tracks; particularly on guitars, bass and electric keys. Universal Audio has been commissioned by Roland to accurately model the CE-1, and the results are nothing short of spectacular.

### Roland CE-1 Screenshot



Figure 81. The Roland CE-1 plug-in window

## Roland CE-1 Controls

The Roland CE-1 has two operating modes, chorus and vibrato. Only one mode can be active at a time. The operating mode is set using the Vibrato/Chorus switch.

### Clip LED



The red Clip LED illuminates when signal peaks in the plug-in occur.

### Normal/Effect Switch



This is an effect bypass switch. Click to enable/disable the chorus or vibrato effect. The effect that will be heard is determined by the Vibrato/Chorus switch.

The active state is black text. The inactive state has gray text. The default state is effect.

This is not a plug-in bypass switch. The hardware CE-1 has a slight affect on the sound even when the effect is “bypassed” in normal mode. We have modeled the plug-in faithfully and like the hardware unit, when the effect is bypassed with this switch, audio is still processed to sound like the CE-1 in “normal” mode. To disable audio processing, use the CE-1 Power Switch.

### Rate LED



The yellow Rate LED blinks according to the current low-frequency oscillator (LFO) rate. When CE-1 is in Vibrato mode, the LFO rate is determined by the vibrato rate knob. When in Chorus mode, this LED is affected by the Intensity knob.

**Note:** In Chorus mode, the fastest LFO rate is slower than the slowest LFO rate in Vibrato mode.

### Vibrato/Chorus Switch



This switch determines the operating mode of the plug-in. Click to switch between chorus and vibrato modes.

The active mode is black text. The inactive mode has gray text. The default mode is chorus.

## Stereo Mode Switch

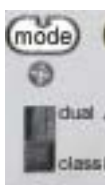

The Stereo Mode switch determines the operating mode of CE-1 when the plug-in is used in a configuration with stereo input, such as a stereo audio track insert or stereo effects bus.

The hardware CE-1 has only a monophonic input. Its output can be mono (wet and dry signal mixed at one output jack) or stereo (dry signal in one output jack, wet signal in other output jack). We've adapted the model for the modern era, enabling a true stereo input.

**Note:** This switch has no affect in a mono-in/mono-out or mono-in/stereo-out configuration.

When CE-1 is used in a stereo input configuration, the Stereo Mode switch affects the output as follows:

### Dual Mode

In Dual mode the CE-1 behaves as a dual-mono device, functioning as two independent CE-1's, each running in mono mode on one side of the stereo signal.

The left output contains a mix of the dry left input signal and the processed left channel signal, while the right output contains a mix of the dry right input signal and the processed right channel signal. Additionally, the LFO's of the dual CE-1 channels are 90 degrees out of phase (quadrature) for maximum effect.

### Classic Mode

In Classic mode, the CE-1 behavior is similar to that of a mono-in/stereo out configuration. The left and right channel inputs are mixed to mono, and the dry signal (mixed left and right channels) appear at the left output, and the wet effect signal appears at the right output.

## Output Level Knob



This knob determines the signal level at the output of the plug-in. The range is 0 – 100%.

**Note:** This is not a wet/dry mix control.

## Chorus Intensity Knob



When CE-1 is in chorus mode, the amount of chorusing effect is determined by this knob.

**Note:** When in vibrato mode, chorus intensity has no affect.

## Vibrato Controls



These two knobs control rate and depth of the vibrato effect when CE-1 is in vibrato mode.

### Depth Knob

The depth knob controls the intensity of the vibrato effect.

### Rate Knob

The rate knob controls the rate of the vibrato LFO. The rate is indicated by the the Rate LED indicator.

*Note: When in chorus mode, the vibrato controls have no affect.*

## Power Switch



This switch determines whether the plug-in is active. This is useful for comparing the processed settings to that of the original signal, or to bypass the plug-in to reduce the UAD DSP load.

Click the rocker switch to change the Power state.



## CHAPTER 28

# Roland Dimension D

### Overview

The Roland SDD-320 Dimension D is another classic effect faithfully reproduced by our ace modeling engineers. The Dimension D is a one of a kind studio gem that adheres to the principle of doing one thing, and doing it extremely well. Its one and only function: some of the best sounding stereo chorus ever made. However, the Dimension D is more than a chorus, it is really a unique sound enhancer for adding spatial effects to mono or stereo sources. The Dimension D does not create a dramatically new sound, but enhances the characteristics of any voice or instrument, and gives a new “dimension” without the apparent movement of sound produced by other chorus devices. The strength of the Dimension D is in its subtlety.

This classic 1979 Roland device has been heard on countless records, from luminaries such as Peter Gabriel, Talking Heads and INXS. Entrusted by the Roland company to emulate this classic studio tool, Universal Audio went to great lengths to preserve this Bucket Brigade chorus with all its unique design elements and sonic characteristics. With only four pushbutton ‘dimension’ settings, the Dimension D is the ultimate in functional simplicity.

### Roland Dimension D Screenshot

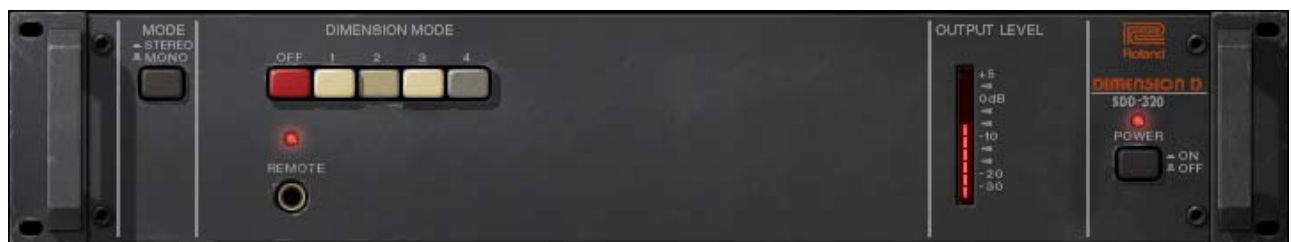

Figure 82. The Roland Dimension D plug-in window

## Roland Dimension D Controls

The Roland Dimension D is very simple device to operate; it has only three controls: Power, Mono, and Mode. Each control is detailed below.

### Dimension Mode



The Dimension Mode determines the effect intensity. Four different modes are available. Mode 1 is the most subtle effect, and Mode 4 is maximum intensity.

### Multiple Buttons

True to the original hardware, multiple Dimension Mode buttons can be engaged simultaneously for subtle sonic variations of the four main modes. To engage multiple Dimension Mode buttons, press the Shift key on the computer keyboard while clicking the Mode buttons.

### Input Mode Switch



The original Roland Dimension D has an input switch on the back that puts the unit into mono-in/stereo-out mode. We have included this function and moved the switch "to the front" for your processing convenience.

When in Mono mode, the input to Dimension D is monophonic even when used in a stereo-input configuration (stereo inputs are summed to mono). This can be useful for sonic variation, such as when the plug-in is used in an auxiliary/effect send configuration.

The default position (in) is stereo mode. Click the pushbutton switch (out) to enable Mono mode.

### Power Switch



This switch determines whether the plug-in is active. This is useful for comparing the processed settings to that of the original signal, or to bypass the plug-in to reduce the UAD DSP load. Click the pushbutton switch to change the Power state.

### Power LED

The Power LED is illuminated when the plug-in is active.

### Output Level



This LED-style meter indicates the level of the signal at the output of the plug-in.

When the Dimension Mode is OFF but the Power switch is ON, audio is not processed but the Output Level meter is still active.

# Roland RE-201



## Overview

In 1973, Roland created the Space Echo system that utilized multiple play heads to create warm, highly adjustable echo effects, which added wonderful tape character and chaos to performances and recordings. The Space Echo can be heard on numerous recordings, from 70's space rock like Pink Floyd and David Bowie, to countless Reggae and Dub albums, to more recent bands like Portishead and Radiohead. Universal Audio has been entrusted by Roland to re-create the highly beloved RE-201 unit, considered the best of the Space Echo line. Our team spent over a year developing our RE-201 Space Echo, which truly captures the physical behavior of this complex device "warts and all", down to the distortion, wow and flutter, pitch shifting, and warmth that tape based delays are famous for; but our plug-in goes even further, capturing the complex self-oscillation that makes the Space Echo more than an effect, but a unique instrument unto itself.

UA's RE-201 Space Echo faithfully retains all the controls and features of the original, such as the Mode Selector for various head combinations, Repeat Rate for fine timing control, and Intensity which sets repeat count and allows the unit to achieve self-oscillation. The all-important Echo/Normal "Dub" switch is retained for muting, as well as the simple tone controls. Last but certainly not least, the atmospheric shimmer of the Space Echo's spring reverb is faithfully captured, putting this fantastic plug-in on par with the original unit as a tool of infinite creativity.

## Roland RE-201 Screenshot



Figure 83. The Roland RE-201 plug-in window

## Roland RE-201 Interface

The RE-201 interface is true to the original hardware, with a few customizations to bring it into the digital era.

The original mic and instrument volume controls have been replaced with echo/reverb pan controls and an input control. We've also added a "Tape Age" switch to emulate new and older tape, a Wet Solo control for use as a bus/send effect, and an output volume control for utility. The clever "Splice" switch allows the user to trigger the tape splice at will.

Tempo synchronization controls round out the modernization of this classic analog processor. The fabulous sound of the original is untouched!

## Roland RE-201 Controls

Each feature of the Roland RE-201 interface is detailed below.

### Peak Level



The Peak lamp indicates when transient signal peaks and clipping are detected just after the input volume control. It begins illuminating at approximately  $-2\text{dB}$  to  $-1.5\text{dB}$ , then gets brighter as the level increases.

### VU Meter



The VU meter indicates the average signal that is about to be written to the "tape." Used in conjunction with the Peak lamp, an indication of signal level can be deduced.

**Note:** The Peak lamp and VU meter measure signal just after the input volume control. However, like the original hardware, echo intensity (feedback) is applied just before the level detection circuit. For this reason, the Intensity control will affect the level readings.

### Echo Pan



Echo Pan determines the placement of the echo signal in the stereo panorama when the plug-in is used in mono-in/stereo-out and stereo-in/stereo-out configurations. When the RE-201 is used in a mono-in/mono-out configuration, this control is disabled.

### Reverb Pan



Reverb Pan determines the placement of the reverb signal in the stereo panorama when the plug-in is used in mono-in/stereo-out and stereo-in/stereo-out configurations. When the RE-201 is used in a mono-in/mono-out configuration, this control is disabled.

### Input Volume



This control determines the signal level that is input to the plug-in. Unity gain is at the 12 o'clock position.

Like the original hardware, clipping distortion at the input to the plug-in affects the tone of the echo and reverb. Clipping is often used as part of the desired effect. At unity gain clipping can be easily induced. However if a cleaner sound is desired, reduce the input volume below unity and increase the plug-in output volume to compensate.

### Mode Selector



The RE-201 is a combination of a tape echo and a spring reverb effect. Echo, reverb, or both can be selected with the Mode Selector to determine which effect(s) are active.

The original Space Echo has three tape playback heads. By changing the combination and positions of the heads, a total of 12 different echo variations can be obtained (4 echo only, 7 echo/reverb, and 1 reverb only). These modes are faithfully reproduced with the UAD Roland RE-201.

**Note:** The RE-201 uses less UAD DSP in reverb-only or echo-only modes versus when both modes are used simultaneously.

The affect of each knob position is detailed in [Table 15 on page 246](#).

Table 15. RE-201 Mode Selector Positions

Mode Knob Position		REPEAT (echo only)				REVERB + ECHO						REVERB ONLY	
		1	2	3	4	5	6	7	8	9	10	11	Reverb
Active	1	•				•			•		•	•	
Tape Heads	2		•		•		•		•	•		•	
	3			•	•			•		•	•	•	
Active Reverb						•	•	•	•	•	•	•	•

### Bass



This knob controls the low frequency response in the tape echo portion of the signal. It does not affect the dry signal or the reverb signal. This is a cut/boost control; it has no effect when in the 12 o'clock (straight up) position.

### Treble



This knob controls the high frequency response in the tape echo portion of the signal. It does not affect the dry signal or the reverb signal. This is a cut/boost control; it has no effect when in the 12 o'clock (straight up) position.

### Reverb Volume



This control determines the volume of the spring reverb effect. Rotate the control clockwise for more reverb. Reducing the control to its minimum value will disable the reverb.

On the original hardware the reverb output is quite low, and with some sources, unusable due to a high noise floor. Our model of the spring reverb has no noise, and has an increased available output level to improve usability.

**Note:** *Reverb Volume has no affect when the Mode Selector is in positions 1 through 4.*

### Output Volume



This control determines the output volume of the plug-in. It affects the dry and effect signals.

The range of this control is  $\pm 20$ dB from unity gain. Therefore, some signal may still be heard when this control is set to its minimum value.

## Repeat Rate



This knob controls the time interval of the echo effect. Rotating the control clockwise will decrease the delay time, and counter-clockwise rotation will increase the delay time.

The available delay times are as follows:

- Head 1: 69ms – 177ms
- Head 2: 131ms – 337ms
- Head 3: 189ms – 489ms

The head times available with this control are dependent upon the “[Mode Selector](#)” on page 245. As with the original hardware, this control varies the tape playback speed in realtime by manipulating the tape capstan motor and therefore has a musically useful “ramp-up” and “ramp-down” effect.

When Tempo Sync is enabled, this control is quantized to allow only rhythmic notes available at the leading head.

## Intensity



This knob controls the repeat level (feedback) of the echo signal. Rotating the control clockwise increases the number of echoes. Higher values will cause self-oscillation; the exact position is program and Mode dependent.

The self-oscillation of the RE-201 is one of the magic features that really makes it more than a mixing tool, but also an instrument to be played. The effect may be used subtly, sending the unit into gentle oscillation on held notes, or can be put into “over the top” oscillation with extreme intensity settings. Different Modes will reveal different qualities of oscillation. Single head Modes tend to have simpler oscillation qualities, while multiple head modes will have a more complex sound when oscillating.

The RE-201’s oscillation qualities are heavily program and control dependent. Different sources of audio, gain, tone repeat rate and tape settings will all effect “oscillation performance.” The RE-201 can also achieve oscillation with no signal, making the RE-201 a truly unique instrument.

## Echo Volume



This control determines the volume of the echo effect. Rotate the control clockwise for louder echo. Reducing the control to its minimum value will disable the echo.

**Note:** Echo Volume has no effect when the Mode Selector is in the “Reverb Only” position.

### Power Switch



This switch determines whether the plug-in is active. This is useful for comparing the processed settings to that of the original signal, or to bypass the plug-in to reduce the UAD DSP load. Toggle the switch to change the Power state.

Toggle the power switch will also clear the tape echo. This can be useful if the RE-201 is self-oscillating and restarting the feedback loop is desired.

### Echo/Normal



This switch disables the signal sent into the echo portion of the processor when set to NORMAL. The switch will have no effect if “Mode Selector” on page 245 is set to “Reverb Only.” This control is sometimes affectionately referred to as the “dub” switch.

### Sync



This switch puts the plug-in into tempo sync mode. See Chapter 8, “Tempo Sync” for information, including additional sync info specific to the RE-201 (page 87).

### Delay Time Display



These LCD-style readouts display the current delay time(s) of the RE-201. The three displays correspond to the three virtual “heads” in the plug-in, and always maintain their proportional relationship to each other.

The delay time values are displayed in milliseconds unless tempo sync is active, in which case beat values are displayed. When a particular head is inactive (see “Mode Selector” on page 245), a dash is displayed.

When in tempo sync mode, note values that are out of range will flash. Imprecise note values due to head relationships are displayed with superscript + or – symbol before the note.

### Tape Age



In the original hardware, the tape loop is contained in a user-replaceable cartridge. As the tape wears out, it is subject to fidelity loss plus increased wow and flutter. The Tape Age switch allows the plug-in to mimic the behavior of new, used, and old tape cartridges.

Newer tape may be ideal for a pristine vocal track, while older tape could be described as having more “character” and might be more appropriate for sources where greater chaos may be musical.



## Splice



Normally, the splice on the tape loop comes around at regular intervals. This interval varies, and is determined by the selected Repeat Rate. Depending on what Tape Quality is selected, the splice can be subtle or obvious, and can work as a catalyst for chaos especially when the RE-201 is in a state of self-oscillation.

This switch resets the location of the tape "splice" when the switch is actuated. It is a momentary switch that pops back into the off position immediately after it is activated, allowing the user to trigger the splice point at will.

Note that the splice effect isn't immediate. It drops the splice at the write head, and it needs time to go over the read heads (at which point there will be a dropout), and then the tape capstan (where it will create some wow and flutter).

## Wet Solo



When this switch is OFF, the dry/unprocessed signal is mixed with the wet/processed signal. When set to ON, only the processed signal is heard.

Wet Solo is useful when the plug-in is placed on an effect group/bus that is configured for use with channel sends. When the plug-in is used on a channel insert, this control should generally be OFF.

***Note:** Wet Solo is a global (per RE-201 plug-in instance) control. Its value is not saved within presets.*

## Caution :-D

If the RE-201 generates noise after installation, changing the location or position is indicated to correct the situation. Avoid prolonged use in dusty, hot or high humidity places.

Roland® and RE-201 Space Echo® are registered trademarks of Roland Corporation, Japan and are used under license. Portions of this RE-201 manual section is ©copyright Roland Corporation, Japan and are used under license with kind permission from Roland.

## CHAPTER 30

# RealVerb Pro

### Overview

RealVerb Pro uses complex spatial and spectral reverberation technology to accurately model an acoustic space. What that gets you is a great sounding reverb with the ability to customize a virtual room and pan within the stereo spectrum.

### Room Shape and Material

RealVerb Pro provides two graphic menus each with preset Room Shapes and Materials. You blend the shapes and material composition and adjust the room size according to the demands of your mix. Controls are provided to adjust the thickness of the materials – even inverse thickness for creative effects. Through some very clever engineering, the blending of room shapes, size and materials may be performed in real-time without distortion, pops, clicks or zipper noise. Once you've created your custom room presets, you can even morph between two presets in real-time, with no distortion.

### Resonance, Timing and Diffusion

RealVerb Pro also includes intuitive graphic control over equalization, timing and diffusion patterns. To maximize the impact of your recording, we put independent control over the direct path, early reflections and late-field reverberation in your hands.

### Stereo Soundfield Panning

Capitalizing on the psychoacoustic technology that went into the design of RealVerb 5.1, we have incorporated some of those principals into RealVerb Pro. Our proprietary Stereo Soundfield Panning allows you to spread and control the signal between stereo speakers creating an impression of center and width. The ability to envelop your listener in a stereo recording is an entirely new approach to reverb design.

Don't rely on your old standby. Let RealVerb Pro bring new quality and space to your recordings!

# RealVerb Pro Background

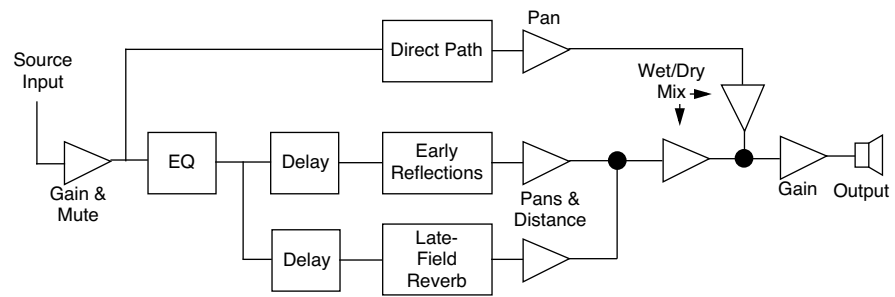

Figure 84. RealVerb Pro signal flow

Figure 84 illustrates the signal flow for RealVerb Pro. The input signal is equalized and applied to the early reflection generator and the late-field reverberation unit. The resulting direct path, early reflection, and late-field reverberation are then independently positioned in the soundfield.



Figure 85. The RealVerb Pro plug-in window

The RealVerb Pro user interface is similarly organized (see [Figure 85](#)). Reflected energy equalization is controlled with the Resonance panel. The pattern of early reflections (their relative timing and amplitudes) is determined by the room shapes and sizes in the Shape panel; early reflection predelay and overall energy is specified at the top of the Timing panel. The Material panel is used to select relative late-field decay rates as a function of frequency. The overall late field decay rate is chosen along with the room diffusion, late-field predelay, and late-field level at the bottom of the Timing panel. Finally, the Positioning panel contains controls for the placement of the source, early reflections, and late-field reverberation.

## Spectral Characteristics

The Shape and Material panels specify the room shape, room size, room material and thickness. These room properties affect the spectral characteristics of the room's reflections.

### Shape and Size

The pattern of early reflections in a reverb is determined by the room shape and size. RealVerb Pro lets you specify two room shapes and sizes that can be blended to create a hybrid of early reflection patterns. There are 15 room shapes available, including several plates, springs, and classic rooms; room sizes can be adjusted from 1–99 meters. The two rooms can be blended from 0–100%. All parameters can be adjusted dynamically in real time without causing distortion or other artifacts in the audio.

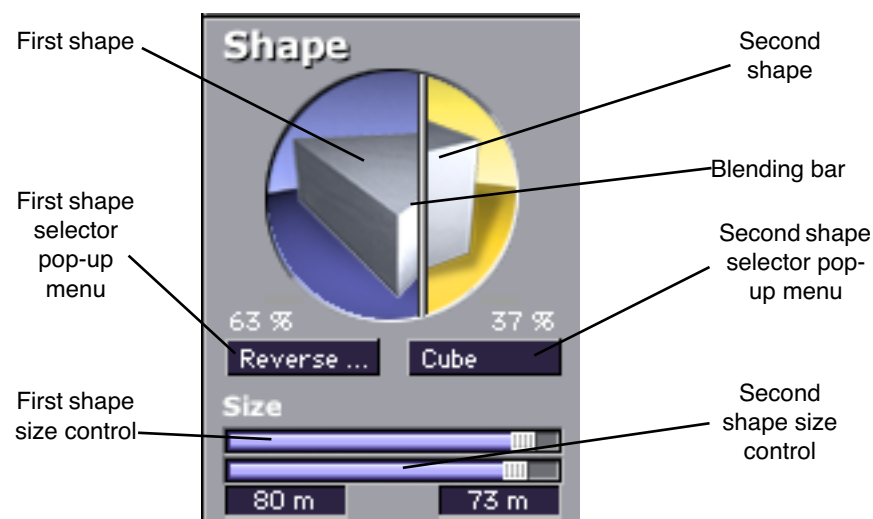

Figure 86. RealVerb Pro Shape panel

**To configure the room shape and size:**

1. Select a room shape from the first (left) pop-up menu. The selected shape appears in the left side of the Shape circle. Adjust the room size with the top horizontal slider.
2. Select a room shape from the second (right) pop-up menu. The selected shape appears in the right side of the Shape circle. Adjust the room size with the bottom horizontal slider.
3. Blend the early reflection patterns of the two rooms by dragging the Blending bar. The relative percentages of the two rooms appear above their pop-up menus. Drag to the right to emphasize the first room shape; drag to the left to emphasize the second room shape. To use only one room shape, drag the Blending bar so the shape is set to 100%.

The resulting early reflection pattern is displayed at the top of the Timing panel (see [Figure 89 on page 259](#)), where each reflection is represented by a yellow vertical line with a height indicating its arrival energy, and a location indicating its arrival time.

**Material and Thickness**

The material composition of an acoustical space affects how different frequency components decay over time. Materials are characterized by their absorption rates as a function of frequency—the more the material absorbs a certain frequency, the faster that frequency decays. RealVerb Pro lets you specify two room materials with independent thicknesses, which can be blended to create a hybrid of absorption and reflection properties. For example, to simulate a large glass house, a blend of glass and air could be used.

There are 24 real-world materials provided, including such diverse materials as brick, marble, hardwood, water surface, air, and audience. Also included are 12 artificial materials with predefined decay rates. The thickness of the materials can be adjusted to exaggerate or invert their absorption and reflection properties. For a description of the different room materials, see [“About the Materials” on page 255](#).

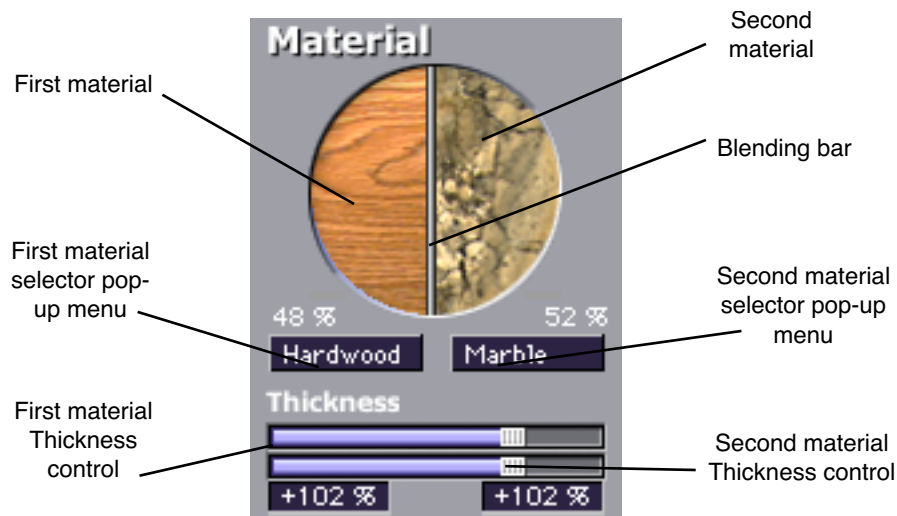

Figure 87. RealVerb Pro Material panel

**Note:** While materials are used to control decay rates as a function of frequency, the overall decay rate of the late-field reverberation is controlled from the Timing panel (see Figure 89 on page 259).

**To configure the room material and thickness:**

1. Select a room material from the first (left) pop-up menu. The selected material appears in the left side of the Material circle.
2. Adjust the thickness for the first material with the top horizontal slider:
  - A default thickness of +100% yields normal, real-world decays for the material.
  - Thicknesses beyond the default (up to +200%) exaggerate how the frequencies are absorbed and reflected.
  - Negative thicknesses invert the response of the material. If the material normally absorbs high frequencies (causing them to decay quickly) and reflects low frequencies (causing them to decay slowly), a negative thickness will instead absorb low frequencies (causing them to decay quickly) and reflect high frequencies (causing them to decay slowly).
  - A thickness of 0% yields decay rates that are not affected by the material.
3. Select a material from the second (right) pop-up menu. The selected material appears in the right side of the Material circle. Adjust the material thickness with the bottom horizontal slider.

## About the Materials

4. Blend the absorption properties of the two materials by dragging the Blending bar. The relative amount of each material, expressed as a percentage, appears above their respective pop-up menu. Drag the Blending bar to the right to emphasize the first material, and drag it to the left to emphasize the second material. To use only one room material, drag the Blending bar so the material is set to 100%.

Some materials absorb high frequencies and reflect low frequencies, while other materials absorb low frequencies and reflect high frequencies. This characteristic is determined by the material surface and density.

Fiberglass, for example, absorbs high frequencies. When high frequencies strike fiberglass they bounce around inside the fibers and lose much of their energy.

At a thickness of 100%, fiberglass rolls off the high frequencies, a little bit each millisecond. After a while the high frequencies dissipate and the low frequencies linger. If we were to take fiberglass and increase its thickness to +200%, the high frequencies would roll off even faster. At +200%, this high frequency decay happens at twice its normal rate, producing a very heavy reverberant tail. At -200%, a very “sizzly” late field is created.

Some materials, such as plywood, naturally absorb low frequencies while reflecting high frequencies. Since plywood is usually very flat with little surface texture to capture high frequencies, high frequencies tend to be reflected. At +100%, the reverberation produced is very sizzly and increasingly bright. At -100%, it is very heavy.

Keeping this in mind, if you look at the graphics in the material control panel, you can get a sense of how chosen materials, material blend, and thickness will affect the decay rate as a function of frequency. Hard materials that have lots of small cavities (Brick, Gravel, Plaster on Brick) and soft materials (Carpet, Grass, Soil) tend to absorb high frequencies. Flat, somewhat flexible materials (Heavy Plate Glass, Hardwood, Seats) tend to reflect high frequencies. Marble is the one material that tends to uniformly reflect all frequencies.

You probably noticed the artificial materials the top of the Materials menu. These are materials designed to have predictable behavior and can be very handy for achieving a desired reverberation preset when you know what decay rates you desire. All these materials preferentially absorb high frequencies; they give the selected decay time at low frequencies, and a much shorter decay time at high frequencies. The frequency in each graphic is the transi-

tion frequency, the frequency at which the decay rate is halfway between the low-frequency and high-frequency values. At 100% thickness, the ratio of low-frequency to high-frequency decay times is 10:1. This means that the high frequencies will decay 10 times faster than the low frequencies. At 200% thickness, this is multiplied by two (high frequencies decay at 20x the rate of the low frequencies). At negative 100%, the sense of low frequency and high frequency is swapped —low frequencies decay 10 times faster than the high frequencies.

Many hardware and software reverbs tend to compensate for the high frequency absorption that air provides. RealVerb Pro instead provides “Air” as a material. If you do not choose to use Air as one of the materials, you can effectively compensate for the high frequency absorption properties of air with the Resonance filters. Set the right-hand Transition Frequency slider to 4.794 kHz, and bring the level down about -10 dB to -15 dB for large to huge rooms, and down about -4 dB to -9 dB for small to medium rooms.

To help you out, the following lists classify the materials under two headings: those that tend to reflect high frequencies, and those that tend to absorb them. They are listed in order of their transition frequencies, from lowest to highest.

Table 16. Materials with high-frequency absorption

Audience	Fiberglass
Cellulose	Grass
Drapery	Plaster on Brick
Plaster on Concrete Block	Water Surface
Soil	Sand
Gravel	Brick
Paint on Concrete Block	Air
Carpet	

Table 17. Materials with high-frequency reflection

Heavy Plate Glass	Seats
Plywood	Marble
Hardwood	Concrete Block
Glass Window	Linoleum
Cork	



## Resonance (Equalization)

The Resonance panel has a three-band parametric equalizer that can control the overall frequency response of the reverb, affecting its perceived brilliance and warmth. By adjusting its Amplitude and Band-edge controls, the equalizer can be configured as shelf or parametric EQs, as well as hybrids between the two.

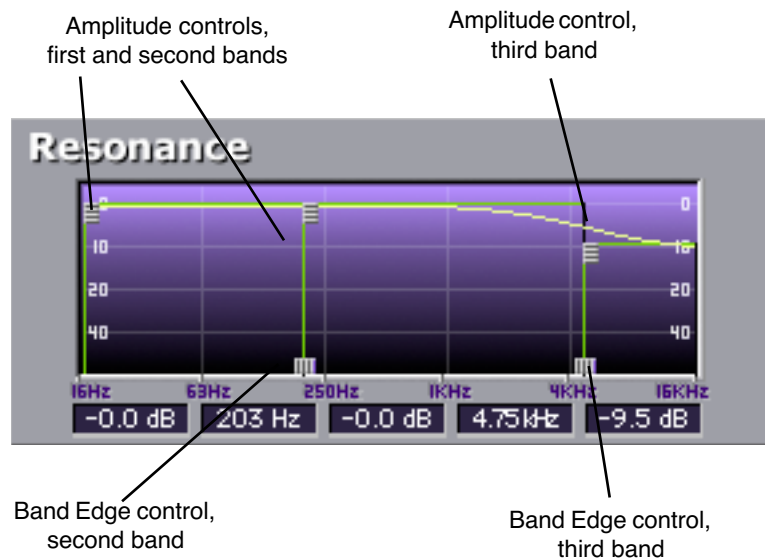

Figure 88. RealVerb Pro Resonance panel

### To configure the reverb's Resonance as a parametric EQ:

1. Drag the Band Edge controls horizontally for the second and third bands to the desired frequencies. The first band is preset to 16 Hz. The frequencies for all three bands are indicated in the text fields at the bottom of the Resonance panel.
2. Adjust the amplitude of the bands (from -60 dB to 0 dB) by dragging their Amplitude controls either up or down. The amplitude values for all three bands are indicated in the text fields at the bottom of the Resonance panel. The shape of the EQ curve is displayed in the Resonance graph.

### To configure the reverb's Resonance as a high-shelf EQ:

1. Drag the Amplitude control for the second EQ band all the way down.
2. Drag the Amplitude controls for the first and third bands all the way up, to equal values.

3. Adjust the Band-edge controls for the second and third bands so they are adjacent to each other. To raise the frequency for the high-shelf, drag to the right with the Band-edge control for the second band. To lower the frequency for the high-shelf, drag to the left with the Band-edge control for the third band.
4. To attenuate the frequencies above the shelf frequency, drag the Amplitude controls for the first and second bands up or down. For a true shelf EQ, make sure these amplitudes are set to equal values.

**To configure the reverb's Resonance as a low-shelf EQ:**

1. Drag the Amplitude control for the second EQ band all the way up.
2. Drag the Amplitude controls for the first and third bands all the way down, to equal values.
3. Adjust the Band-edge controls for the second and third bands so they are adjacent to each other. To raise the frequency for the low-shelf, drag to the right with the Band-edge control for the second band. To lower the frequency for the low-shelf, drag to the left with the Band-edge control for the third band.
4. To attenuate the frequencies below the shelf frequency, drag the Amplitude controls for the first and second bands up or down. For a true shelf EQ, make sure these amplitudes are set to equal values.

## Timing

The Timing panel offers control over the timing and relative energies of the early reflections and late-field reverberations. These elements affect the reverb's perceived clarity and intimacy. The early reflections are displayed at the top of the Timing panel, with controls for Amplitude and Pre-delay. The late-field reverberations are displayed at the bottom, with controls for Amplitude, Pre-delay, and Decay Time. To illustrate the relation between both reverb components, the shape of the other is represented as an outline in both sections of the Timing panel (see [Figure 89](#)).

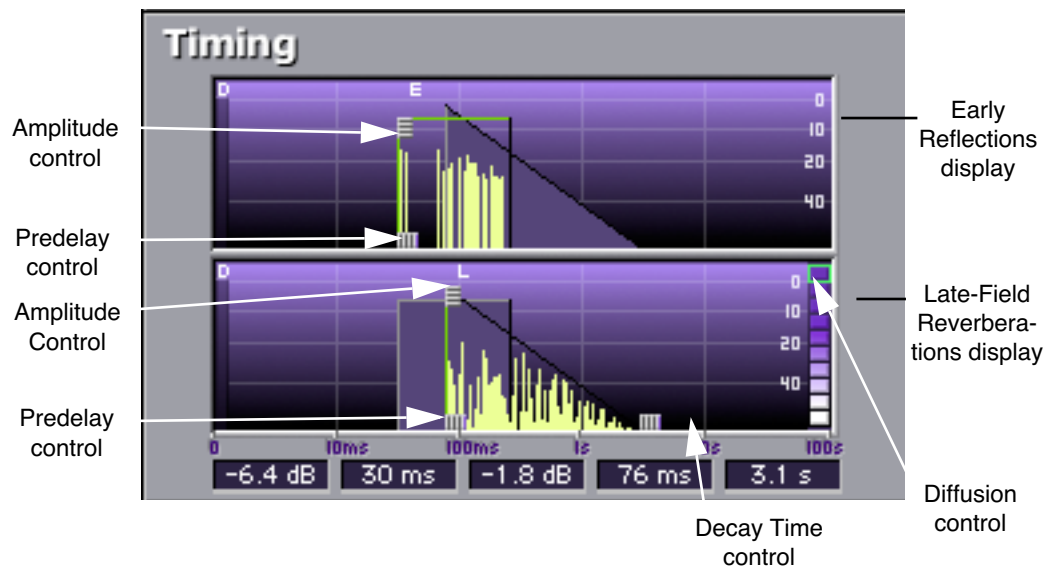

Figure 89. RealVerb Pro Timing panel

**To adjust the timing of the early reflections:**

1. Drag the Amplitude control for the early reflections up or down (from  $-80$  dB to 0 db) to affect the energy of the reflections. The Amplitude value is indicated in the text field at the bottom of the Timing panel.
2. Drag the Predelay control for the early reflections left or right (from 1–300 milliseconds) to affect the delay between the dry signal and the onset of early reflections. The Pre-delay time is indicated in the text field at the bottom of the Timing panel.

**Note:** The length in time of the early reflections cannot be adjusted from the Timing panel, and instead is determined by the reverb’s shape and size (see Figure 86).

**To adjust the timing of the late-field reverberations:**

1. Drag the Amplitude control for the late-field reverberations up or down (from  $-80$  dB to 0 db) to affect the energy of the reverberations. The Amplitude value is indicated in the text field at the bottom of the Timing panel.
2. Drag the Predelay control for the late-field reverberations left or right (from 1–300 milliseconds) to affect the delay between the dry signal and the onset of late-field reverberations. The Predelay time is indicated in the text field at the bottom of the Timing panel.

3. Drag the Decay Time control for the late-field reverberations left or right (from 0.10–96.00 seconds) to affect the length of the reverb tail. The Decay Time is indicated in the text field at the bottom of the Timing panel.
4. To affect how quickly the late-field reverberations become more dense, adjust the Diffusion control at the right of Late Reflection display in the Timing panel. The higher the Diffusion value (near the top of the display), the more rapidly a dense reverb tail evolves.

## Positioning

One of the unique features of RealVerb Pro is the ability to separately position the direct path, early reflections, and late-field reverberation. The Position panel (see [Figure 90](#)) provides panning controls for each of these reverb components. In addition, a proprietary Distance control adjusts perceived source distance. These controls allow realistic synthesis of acoustic spaces—for instance listening at the entrance of an alley way, where all response components arrive from the same direction, or listening in the same alley next to the source, where the early reflections and reverberation surround the listener.

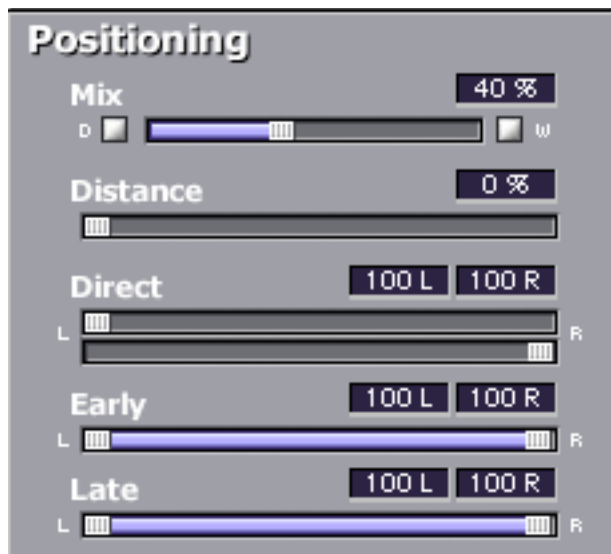

Figure 90. RealVerb Pro Positioning panel

### To pan the direct (dry) signal:

1. Drag the Direct slider left or right. A value of <100 pans the signal hard left; a value of <100> pans the signal hard right. A value of <0> places the signal in the center of the stereo field.

**Set the positioning for the early reflection or late-field reverberation with any of the following methods:**

1. Drag the left and right slider handles to adjust the stereo width. The length of the blue slider is adjusted. For a full stereo signal, drag the left handle all the way to left, and right handle all the way to the right.
2. Drag the blue center of the slider left or right to set the positioning of the signal. If you drag all the way to the left or right, the stereo width is adjusted. For a mono signal panned hard left or right, drag the slider all the way to the left or right.

## **Distance**

RealVerb Pro allows you to control the distance of the perceived source with the Distance control in the Positioning panel (see [Figure 90](#)). In reverberant environments, sounds originating close to the listener have a different mix of direct and reflected energy than those originating further from the listener.

**To adjust the distance of the source:**

1. Drag the Distance slider to the desired percentage value. Larger percentages yield a source that is further away from the listener. A value of 0% places the source as close as possible to the listener.

## **Wet/Dry Mix**

The wet and dry mix of the reverb is controlled from the Mix slider in the Positioning panel (see [Figure 90](#)). The two buttons above this slider labeled “D” and “W” represent Dry and Wet; clicking either will create a 100% dry or 100% wet mix.

## Levels

The Levels panel lets you adjust the Input Gain and Output Gain for RealVerb Pro. These levels are adjusted by dragging the sliders to the desired values. You can mute the input signal by clicking the Mute button.

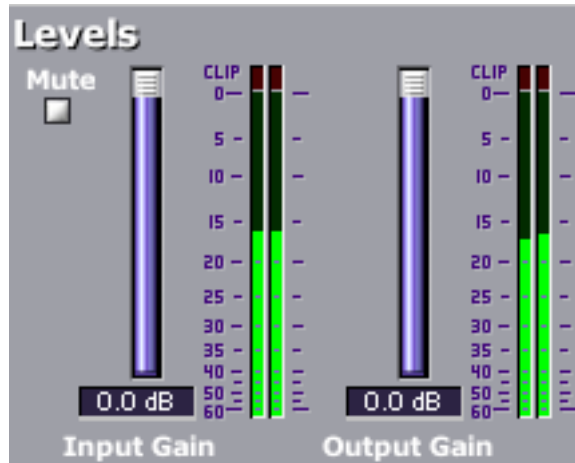

Figure 91. RealVerb Pro Levels panel

## Morphing

All RealVerb Pro controls vary continuously using proprietary technology to smoothly transition between selected values. This capability enables RealVerb Pro to morph among presets by transitioning between their parameter sets. This approach is in contrast to the traditional method of morphing by cross-fading between the output of two static reverberators. The method employed by RealVerb Pro produces more faithful, physically meaningful intermediate states.

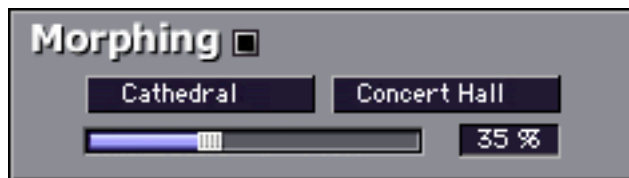

Figure 92. RealVerb Pro Morphing panel

Figure 92 depicts the Morphing Panel. Click the Morphing Mode button to enable Morphing mode. When RealVerb Pro is in morphing mode, the other RealVerb Pro spectral controls are grayed out and cannot be edited. In morphing mode, two presets are selected using the pull-down menus. Once the desired presets are selected in the pull-down menus, the morphing slider is used to morph from one preset to the other.

When in Morphing mode, non user-adjustable controls will change their appearance and will no longer be accessible. When inserted on a Send effect, the 'W' button automatically turns on (to keep the mix at 100% wet).

On an insert effect, the Mix will change back and forth between the two mix values of each preset.



Figure 93. RealVerb Pro in Morphing mode

## RealVerb Pro Preset Management

**Factory Presets** In the preset menu there are thirty factory presets that can be changed by the user. Any modification to a preset will be saved even if you change presets. If you want to return all the presets to their default settings, select “Reset all to Defaults” at the bottom of the presets menu.

Edits to any and all presets in the list are maintained separately within each instance of a plug-in in a session.

### Using Host Application Management

Most host applications include their own method of managing plug-in presets.

For example, the currently selected preset is saved in Cubase/Nuendo when “Save Effect” is used. Morphing parameters and the solo/mute buttons (wet, dry, input) are not saved.

All presets and programs are saved in Cubase/Nuendo when “Save Bank” is used. They are also saved in the session file for each instance of the plug-in.

Editing the name in Cubase/Nuendo modifies the current preset's name. The new name will appear in all preset select lists, and will be saved with the session, bank or effect.

## RealVerb Pro Preset List

Table 18. RealVerb Pro Presets

Acoustic Guitar	Hairy Snare
Apartment Living	High Ceiling Room
Big Ambience	Jazz Club
Big Bright Hall	Large Bathroom
Big Cement Room	Large Dark Hall
Big Empty Stadium	Long Tube
Big Snare	Medium Drum Room
Big Warm Hall	Nice Vocal 1
Cathedral	Nice Vocal 2
Church	Slap Back
Dark Ambience	Small Bright Room
Drums in a Vat	Small Dark Room
Eternity	Sparkling Hall
Far Away Source	Tight Spaces
Ghost Voice	Wooden Hall



## CHAPTER 31

# DreamVerb

### Overview

DreamVerb™, Universal Audio's flagship stereo reverb plug-in, draws on the unparalleled flexibility of RealVerb Pro. Its intuitive and powerful interface lets you create a room from a huge list of different materials and room shapes. These acoustic spaces can be customized further by blending the different room shapes and surfaces with one another, while the density of the air can be changed to simulate different ambient situations.

DreamVerb also features a flexible 5-band active EQ and unique level ramping for the early and late reflections for ultra-realistic dynamic room simulation. And with Universal Audio's proprietary smoothing algorithm, all parameters can be adjusted with automation or in real-time without distortion, pops, clicks, or zipper noise.

DreamVerb provides two graphic menus for selecting preset room shapes. The shapes can be blended according to the demands of your mix. Room materials are selected with two graphic menus containing preset Materials. A third menu specifies the air density for further spectral control. As with the room shapes, the materials and air can be blended as desired.

DreamVerb also includes intuitive graphic control over equalization, timing and diffusion patterns. To maximize the impact of your recording, we put independent control over the direct path, early reflections, and late-field reverberation in your hands.

Capitalizing on the psychoacoustic technology that went into the design of RealVerb Pro, we have incorporated some of these principles into DreamVerb. Our proprietary Stereo Soundfield Panning allows you to spread and control the signal between stereo speakers creating an impression of center and width. The ability to envelop your listener in a stereo recording is an entirely new approach to reverb design.

## Screenshot

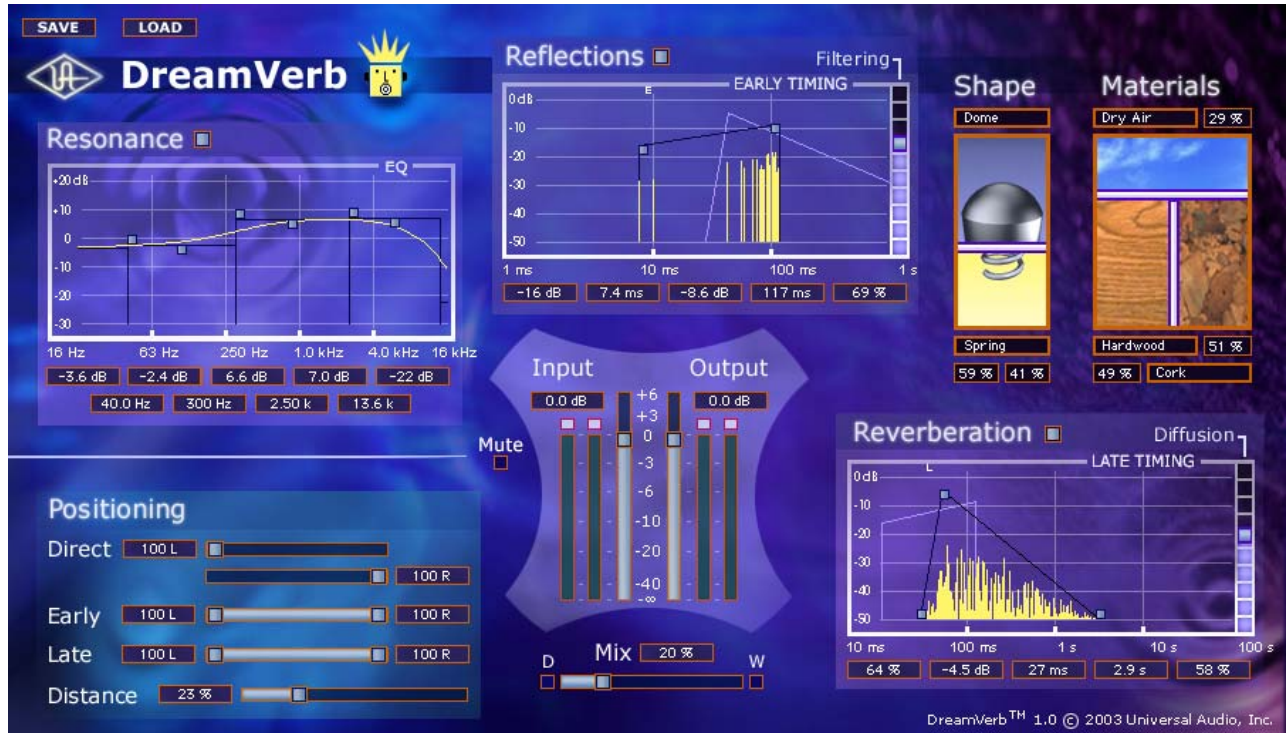

Figure 94. The DreamVerb plug-in window

## Signal Flow

Figure 95 illustrates the signal flow for DreamVerb. The input signal is equalized then delay lines are applied to the early reflection and late field generators. The resulting direct path, early reflection, and late-field reverberation are then independently positioned in the soundfield.

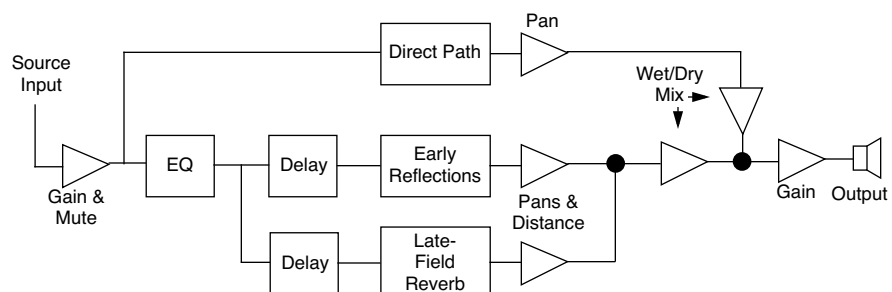

Figure 95. DreamVerb signal flow

The DreamVerb user interface (Figure 94 on page 266) is similarly organized. Reflected energy equalization is controlled with the Resonance panel. The pattern of early reflections (their relative timing and amplitudes) is determined by the room shapes in the Shape panel (Figure 98 on page 269). Early reflection pre-delay, slope, timing, and amplitude are specified in the Reflections panel (Figure 100 on page 274). The Materials panel (Figure 99 on page 271) is used to select relative late-field decay rates as a function of frequency. The late-field pre-delay, decay rate, room diffusion, slope, and level is specified in the Reverberation panel (Figure 101 on page 275). Finally, the Positioning panel (Figure 102 on page 277) contains controls for the placement of the source, early reflections, and late-field reverberation.

## Resonance (Equalization) Panel

The Resonance panel (Figure 96 on page 268) is a five-band equalizer that can control the overall frequency response of the reverb, effecting its perceived brilliance and warmth. By adjusting its Amplitude and band Edge controls, the equalizer can be configured as shelving or parametric EQs, as well as hybrids between the two.

The EQ curve effects the signal feeding both the early reflections and the late field reverberations, but not the direct path.

Bands 1 and 5 are configured as shelving bands. Bands 2, 3, and 4 also have an Edge control for adjusting its bandwidth.

Generally speaking, a lot of high-frequency energy results in a brilliant reverberation, whereas a good amount of low-frequency content gives a warm reverberation.

**Note:** The values for the EQ parameters are displayed in the text fields at the bottom of the Resonance panel. The values can also be entered directly using the text entry method.

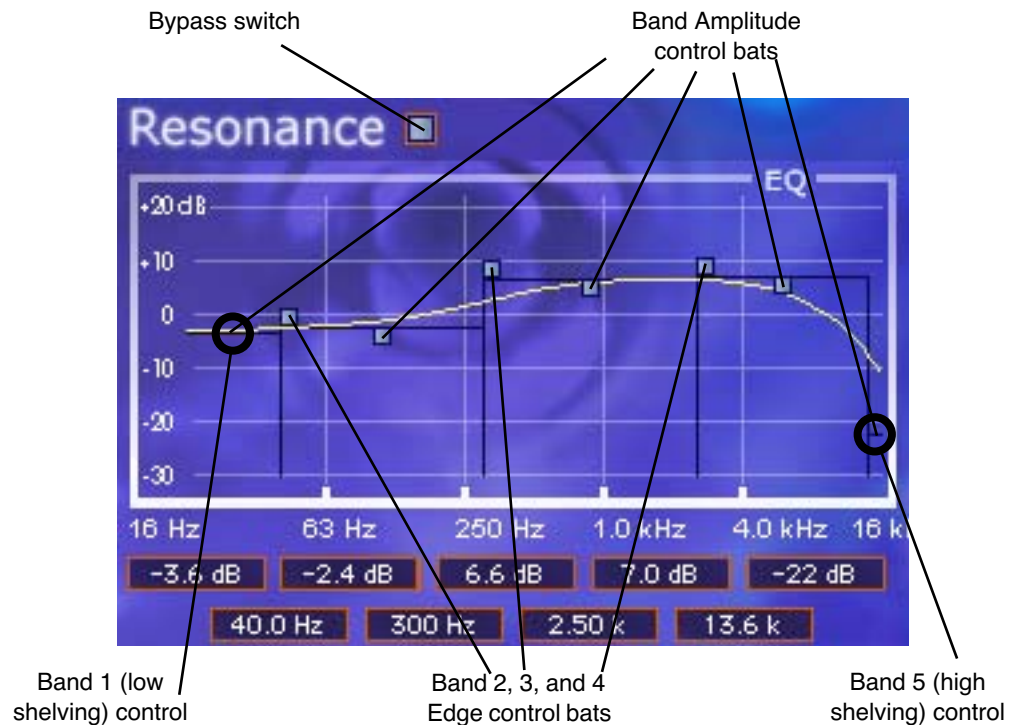

Figure 96. DreamVerb Resonance panel

### **Bypass**

The equalizer can be disabled with this switch. When the switch is off (black instead of grey), the other resonance controls have no effect. This switch has no effect on the direct signal path.

### **Band Amplitude**

Each of the five bands has its own amplitude (gain) control. The amplitude range of each band is -30dB to +20dB.

To adjust the amplitude of bands 2, 3, and 4, grab its control bat and drag vertically or use the direct text entry method. For bands 1 and 5, drag the horizontal line (these do not have a control bat).

### **Band Edge**

Bands 2, 3, and 4 have an Edge control. This parameter effects the bandwidth of the band. To adjust the band edge, grab its control bat and drag horizontally or use the direct text entry method.

The effect of the band edge on the filter sound can depend upon the settings of the adjacent bands. For example, the sonic effect of this parameter is more pronounced if the amplitude of adjacent bands is significantly different than that of the band whose edge is being adjusted.

## Shelving

The simplest (and often most practical) use of the equalizer is for low and/or high frequency shelving. This is achieved by dragging the left-most or right-most horizontal line (the ones without control bats) up or down, which boosts or cuts the energy at these frequencies.

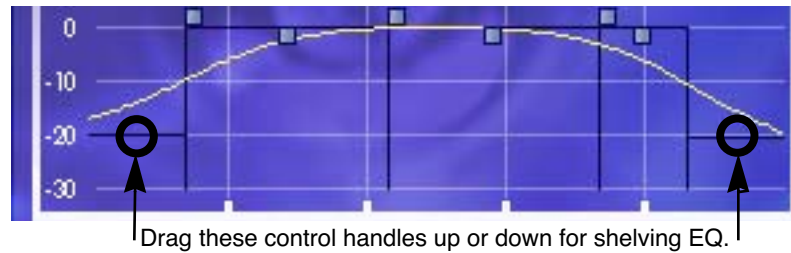

Figure 97. DreamVerb Resonance Shelving Bands

## Shape Panel

The parameters in the Shape panel, in conjunction with the Materials panel (Figure 99 on page 271), effect the spatial characteristics of the reverb.

The pattern of early reflections in a reverb is determined by the room shape(s) and the ER start and end points. Two shapes can be blended from 0–100%. All parameters can be adjusted dynamically in real time without causing distortion or other artifacts in the audio. 21 shapes are available, including various plates, springs, rooms, and other acoustic spaces.

**Note:** The Shape parameters effect only the early reflections. They have no effect on the late field reverberation.

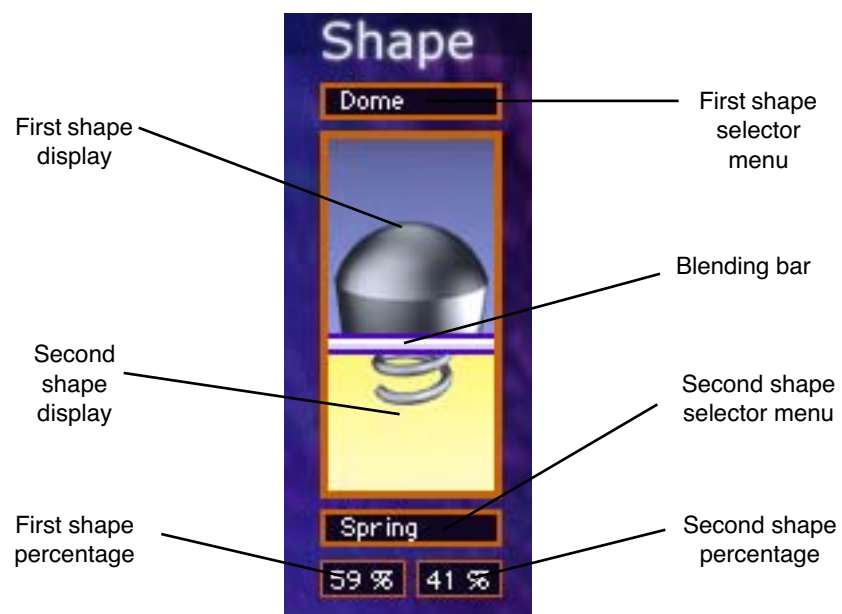
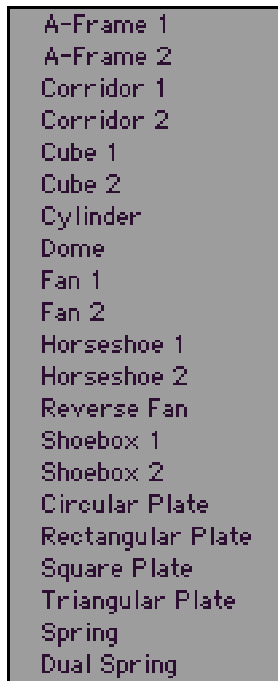

Figure 98. DreamVerb Shape panel

## Shape Menus



- A-Frame 1
- A-Frame 2
- Corridor 1
- Corridor 2
- Cube 1
- Cube 2
- Cylinder
- Dome
- Fan 1
- Fan 2
- Horseshoe 1
- Horseshoe 2
- Reverse Fan
- Shoebox 1
- Shoebox 2
- Circular Plate
- Rectangular Plate
- Square Plate
- Triangular Plate
- Spring
- Dual Spring

DreamVerb lets you specify two room shapes that can be blended to create a hybrid of early reflection patterns. The first and second shape each have their own menu. The available shapes are the same for each of the two shape menus.

The first shape is displayed in the upper area of the Shape panel, and the second shape is displayed in the lower area.

To select a first or second shape, click its shape pop-up selector menu to view the available shapes, then drag to the desired shape and release.

## Shape Blending Bar

The Shape Blending Bar (see [Figure 98 on page 269](#)) is used to blend the two shapes together at any ratio. The two shapes are not just mixed together with this parameter; the early reflections algorithm itself is modified by blending.

Blend the early reflection patterns of the two rooms by dragging the Blending Bar. Drag the bar to the bottom to emphasize the first shape; drag to the top to emphasize the second shape.

The relative percentages of the two rooms appear at the bottom of the Shape panel. To use only one room shape, drag the Blending Bar so a shape is set to 100%.

The resulting early reflection pattern is displayed at the top of the Reflections panel ([Figure 100 on page 274](#)), where each reflection is represented by a yellow vertical line with a height indicating its arrival energy, and a location indicating its arrival time.

## Materials Panel

The parameters in the Materials panel, in conjunction with the Shape panel (Figure 98 on page 269) and Reverberation panel (Figure 101 on page 275) effect the spatial characteristics of the reverb.

The material composition of an acoustical space effects how different frequency components decay over time. Materials are characterized by their absorption rates as a function of frequency—the more the material absorbs a certain frequency, the faster that frequency decays.

**Note:** While materials are used to control decay rates as a function of frequency, the overall decay rate of the late-field reverberation is controlled from the Reverberation panel (see Figure 101 on page 275).

24 real-world materials are provided, including such diverse materials as brick, marble, hardwood, water surface, and audience. Also included are 24 artificial materials with predefined decay rates, and seven air densities.

**Note:** The parameters in the Materials panel always effect the late-field reverberations. However, the materials parameters effect the early reflections ONLY if the “Filtering” parameter in the Reflections panel (Figure 100 on page 274) is set to a non-zero value.

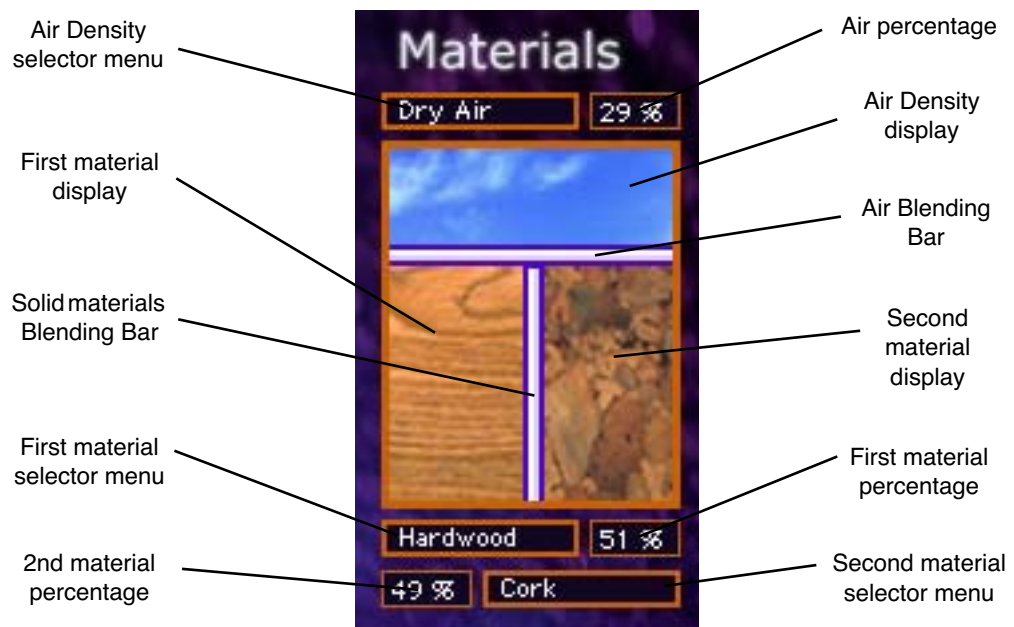

Figure 99. DreamVerb Materials panel

## Materials Menus

DreamVerb lets you specify two room materials, which can be blended to create a hybrid of absorption and reflection properties. The first and second room material each has its own menu. The available materials are the same for each of the two materials menus.

The first material is displayed in the lower left area of the Materials panel, and the second material is displayed in the lower right area.

To select the first or second material, click its material pop-up selector menu to view the available materials, then drag to the desired material and release.

For a discussion of the various materials, see [“About the Materials” on page 255](#).

In addition to the “perfect” materials marked with a K, DreamVerb provides “J” materials that are not found in RealVerb Pro. These perform the inverse of the “K” materials. The materials marked with a J preferentially absorb low frequencies; they give the selected decay time at high frequencies, and a much shorter decay time at low frequencies.

## Air Density Menu

DreamVerb allows you to specify the density of the air in the reverberant space with this menu, enabling another dimension of sonic control.

Ideal Gas  
Dry Air  
Humid Air  
Smokey Club  
Thick Fog  
Inverse Air  
Inverse Thick Fog

The more dense the air is, the more it absorbs high frequencies. At the top of the Air Density menu is Ideal Gas, where no frequencies are absorbed. The air quality increases in density with each selection as you go down the menu.

Inverse Air and Inverse Thick Fog absorb more low frequencies instead of high frequencies.

Air  
Audience  
Brick  
Carpet  
Cellulose  
Concrete Block  
Cork  
Drapes  
Fiberglass  
Glass Window  
Grass  
Gravel  
Hardwood  
Linoleum  
Marble  
Painted Block  
Plaster On Brick  
Plaster On Concrete  
Plate Glass  
Plywood  
Sand  
Seats  
Soil  
Water Surface  
K0175 Hz  
K0250 Hz  
K0350 Hz  
K0500 Hz  
K0700 Hz  
K1.00 KHz  
K1.40 KHz  
K2.00 KHz  
K2.80 KHz  
K4.00 KHz  
K5.60 KHz  
K8.00 KHz  
J0175 Hz  
J0250 Hz  
J0350 Hz  
J0500 Hz  
J0700 Hz  
J1.00 KHz  
J1.40 KHz  
J2.00 KHz  
J2.80 KHz  
J4.00 KHz  
J5.60 KHz  
J8.00 KHz



## Materials Blending Bars

The Materials Blending Bars (see [Figure 99 on page 271](#)) are used to blend the three materials together at any ratio. The materials are not just mixed together with the bars; the reverberation algorithm itself is modified by blending.

### Materials Blending

Blend the two materials by dragging the vertical Blending Bar horizontally. Drag the bar to the right to emphasize the first material; drag to the left to emphasize the second material.

The relative percentages of the two materials appear next to each menu in the Materials panel. To use only one material, drag the Blending Bar so a material is set to 100%.

### Air Blending

Blend the air density with the materials by dragging the horizontal Blending Bar vertically. Drag the bar to the top to emphasize the solid materials; drag to the bottom to emphasize the air.

The percentage of air used appears next to the Air Density menu. To use only solid materials, drag the horizontal Blending Bar to the top so air is set to 0%. To use only air, drag the horizontal Blending Bar to the bottom so air is set to 100%.

## Reflections Panel

The Reflections panel ([Figure 100 on page 274](#)) offers control over the timing and relative energies of the reverb early reflections (ER). These parameters effect the reverb's perceived clarity and intimacy. Each early reflection is visually represented by a yellow vertical line with a height indicating its arrival energy and a location indicating its arrival time.

Unique to DreamVerb is independent control of the amplitude at the early reflection start and end points which facilitates envelope shaping of the reflections. This allows the ability to fade-in or fade-out the reflections to more accurately emulate acoustic environments or for special effects.

**Note:** *The values for the Start and End bats are displayed in the text fields at the bottom of the Reflections panel. These values can also be entered directly using the text entry method.*



Figure 100. DreamVerb Reflections panel

**Bypass** The early reflections can be disabled with this switch. When the switch is off (black instead of grey), the other Reflections controls have no effect. This switch has no effect on the direct signal path.

**Reflections Start** This bat controls two early reflections start parameters. Dragging the bat horizontally controls the ER predelay (the delay between the dry signal and the onset of the ER). Dragging it vertically controls the amplitude of the reflections energy at the ER start time.

**Reflections End** This bat controls two ER end point parameters. Dragging the bat horizontally controls the ER end time (the time at which the ER is no longer heard). Dragging it vertically controls the amplitude of the reflections energy at the end point.

**Filtering** This parameter determines the amount of filtering from the Materials panel to be applied to the early reflections. The Materials effect upon the ER is most pronounced when Filtering is set 100%.

**Note:** The parameters in the Materials panel have no effect on the early reflections unless this parameter value is above 0%.

## Late-Field Relative Timing

To highlight the relative timing relationship between the early reflections and late-field reverberation components, the shape and timing of the late-field is represented as an outline in the Reflections panel. The shape of this outline is modified by parameters in the Reverberations panel, not the Reflections panel.

## Reverberation Panel

The Reverberation panel (Figure 101) contains the parameters that control the late-field (LF) reverb tail for DreamVerb.

The primary spectral characteristics of the late-field reverberation is determined by the parameters in the Materials panel (page 271) in conjunction with the Reverberation panel settings.

**Note:** The values for the late-field controls are displayed in the text fields at the bottom of the Reverberations panel. These values can also be entered directly using the text entry method.

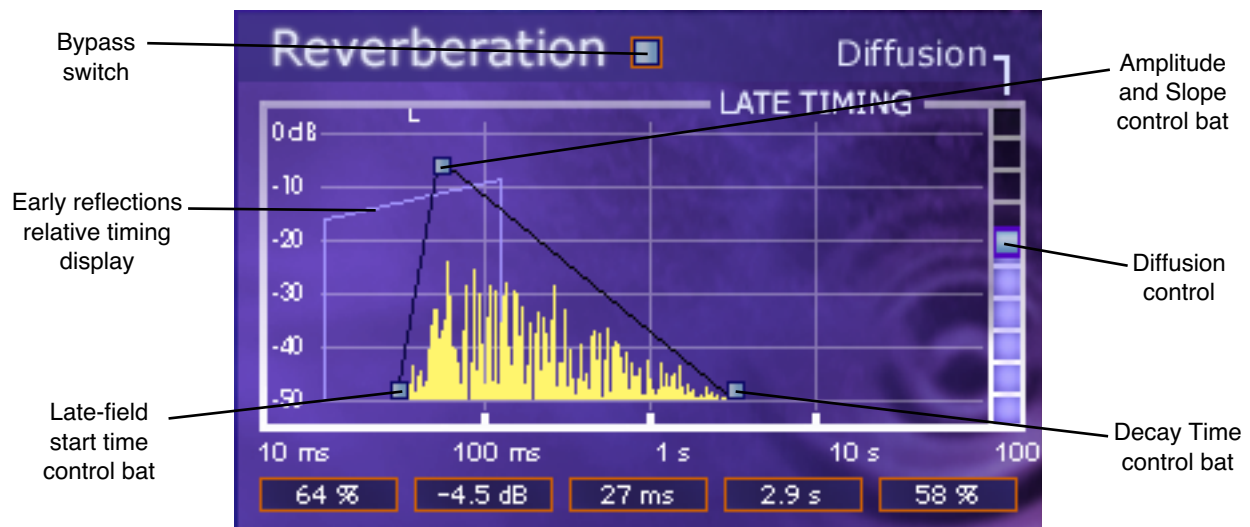

Figure 101. DreamVerb Reverberation panel

## Bypass

The late-field reverberations can be disabled with this switch. When the switch is off (black instead of grey), the other Reflections controls have no effect. This switch has no effect on the direct signal path.

<b>Late-Field Start</b>	This parameter defines when the late-field reverb tail begins (the delay between the dry signal and the onset of the LF) in relation to the dry signal.
<b>Amplitude &amp; Slope</b>	This bat controls two late-field parameters. Dragging the bat vertically controls the maximum amplitude of the LF reverb energy. Dragging it horizontally controls the LF slope (fade-in) time.
<b>Decay Time</b>	This control effects the length of the reverb tail. Drag the bat to the left for a short decay, or to the right for a long decay.
<b>Diffusion</b>	This slider effects how quickly the late-field reverberations become more dense. The higher the Diffusion value, the more rapidly a dense reverb tail evolves.
<b>ER Relative Timing</b>	To highlight the relative timing relationship between the early reflections and late-field reverberation components, the shape and timing of the early reflections is represented as an outline in the Reverberation panel. The shape of this outline is modified by parameters in the Reflections panel, not the Reverberation panel.

## Positioning Panel

DreamVerb has the ability to separately position the direct path, early reflections, and late-field reverberation. The Positioning panel (Figure 102 on page 277) provides panning controls for each of these reverb components. In addition, a proprietary Distance control adjusts perceived source distance. These controls allow realistic synthesis of acoustic spaces—for instance listening at the entrance of an alley way, where all response components arrive from the same direction, or listening in the same alley next to the source, where the early reflections and reverberation surround the listener.

**Note:** *When DreamVerb is used in a mono-in/mono-out configuration, all Positioning controls except Distance are unavailable for adjustment.*



Figure 102. DreamVerb Positioning panel

### Direct

These two sliders control the panning of the dry signal. The upper Direct slider controls the left audio channel, and the lower Direct slider controls the right audio channel.

A value of <100 pans the signal hard left; a value of 100> pans the signal hard right. A value of <0> places the signal in the center of the stereo field.

**Note:** If the DreamVerb “Mix” parameter (page 278) is set to 100% wet or the Wet button is active, these sliders have no effect.

### Early

This slider, which contains two control handles, adjusts the stereo width of the early reflections.

### Late

This slider, which contains two control handles, adjusts the stereo width of the late-field reverberations.

#### Early & Late Adjustment

The left and right slider handles are dragged to adjust the stereo width. For a full stereo spread, drag the left handle all the way to left and right handle all the way to the right. When the slider handles are not set to maximum width, the center of the slider can be dragged left or right to set the positioning of the signal.

To pan a mono signal hard left or right, drag the slider all the way to the left or right.

## Distance

DreamVerb allows you to control the distance of the perceived source with this slider. In reverberant environments, sounds originating close to the listener have a different mix of direct and reflected energy than those originating further from the listener.

Larger percentages yield a source that is farther away from the listener. A value of 0% places the source as close as possible to the listener.

## Levels Panel

This panel is where DreamVerb input/output levels, wet/dry mix, and reverb mute controls can be modified.



Figure 103. DreamVerb Levels panel

## Input

Modifies the signal level at the input to DreamVerb. A value of zero is unity gain.

## Output

Modifies the signal level at the output of DreamVerb. A value of zero is unity gain.

- Mute** This switch mutes the signal at the input to DreamVerb. This allows the reverb tail to play out after mute is applied, which is helpful for auditioning the sound of the reverb. Mute is on when the button is gray and off when the button is black.
- Mix** The wet and dry mix of DreamVerb is controlled with this slider. The two buttons above this slider labeled “D” and “W” represent Dry and Wet; clicking either will create a 100% dry or 100% wet mix.
- Dry** When this button (labeled “D”) is enabled, DreamVerb is 100% dry. It has the same effect as moving the Mix slider to 0%. Dry is on when the button is gray and off when the button is black.
- Wet** When this button (labeled “W”) is enabled, DreamVerb is 100% wet. It has the same effect as moving the Mix slider to 100%. Wet is on when the button is gray and off when the button is black.

## DreamVerb Preset Management

- Factory Presets** In the preset menu there is a bank of 32 factory presets. Presets modified in the bank are saved when another preset within the bank is selected.
- Edits to any and all presets in the list are maintained separately within each instance of a plug-in in a session.

To return to the default factory bank settings, reload the factory bank.

### Save/Load



Not all plug-in hosts include a method for loading and saving plug-in settings. DreamVerb includes Save and Load buttons within the graphical interface itself to accommodate hosts that do not have this feature.

**Note:** Save/Load pre-dates the UAD plug-in Toolbar. We recommend using the Toolbar for consistency. See “UAD Toolbar” on page 74 for details.

The Save/Load feature in DreamVerb supports presets but not banks. To save and load banks, use the host’s bank management feature (if available).

### Default Preset Location

When the Save and Load buttons are used within DreamVerb, the file open and save dialogs default to the same location each time.

## Windows

On Windows systems, the default preset location is inside the Presets directory, which is created within the directory selected during software installation. For example, if the default location was specified when running the UAD Powered Plug-Ins Installer, the location would be:

```
C:\Program Files\Universal Audio\Powered PlugIns\Presets
```

This default location can be changed during installation; the new location will be remembered as the default.

## Macintosh

On OS X systems the default preset location is:

```
Library:Application Support:Universal Audio:Presets
```

## Using Host Application Management

Most host applications include their own method of managing plug-in presets. For example, the currently selected preset is saved in Cubase/Nuendo when “Save Effect” is used. The solo/mute buttons (wet, dry, input) are not saved.

All presets and programs are saved when “Save Bank” is used in the host. They are also saved in the session file for each instance of the plug-in.

Editing the name modifies the current preset's name. The new name will appear in all preset selection lists and will be saved with the session, bank, or effect.

## Spatial Characteristics

### Size

The apparent size of a reverberant space is dependent on many factors. Most reverbs on the market have a “size” parameter, which usually modifies several facets of the reverb algorithm at once. You may notice DreamVerb does not have a “size” parameter. Instead, the elements that control the reverberant space are available to the user.

In DreamVerb, room size is determined by the interaction between all the parameters in the Reflections and Reverberation panels. To get a larger-sounding space, increase the T60 (reverberation time), use proportionally more air, increase the pre-delays, and slightly shift the Resonance transition frequencies to lower values.

### Pre-Delay

Intimacy and remoteness are largely controlled by the pre-delays. Generally speaking, use shorter pre-delays for more intimate spaces. Clear spaces have most of their energy in the first eighty milliseconds or so; muddy spaces have a lot of late arriving energy.



## Space

In some sense, Shape determines the spatial characteristics of the reverberator, whereas Materials effects the spectral characteristics.

## Preset Design Tips

Here are some practical tips for creating useful reverbs with DreamVerb. These are not rules of course, but techniques that can be helpful in designing the perfect sonic environment.

ER = Early Reflections	Hf = High frequency
LF = Late-field Reverberation	Lf = Low frequency

### General Tips (a tour):

- Start by setting a general timing on the ER and LF graphs to give a rough reverb size. This timing ordinarily needs to be tweaked several times along the way.
- The materials and air density define the frequency decay of the LF, and also the coloration of the ER if ER filtering is used (the slider on the right of the Reflections panel).
- Typically, materials should be blended. Try blending contrasting high frequency roll-off materials with high-frequency reflecting materials or inverse materials. This tends to add nice dimension to the LF tail. Start with one useful material and experiment with blending.
- Materials can have an extreme filtering effect if no air density is used. Most presets sound better with an air blending. If you don't want the additional coloration of air, blend with "Ideal Gas" which performs no filtering.
- The room shapes define the ER pattern; they do not effect the LF. Solo the ER and choose a shape that works well for your source or environment.
- Blending shapes does not always yield desirable results. Use shape blending with discretion, or to define a more complex room.
- Start with the EQ flat, set the approximate sound with the materials, then EQ the input to cut or boost specific frequencies.
- The EQ is often most useful for a simple Lf or Hf roll-off/boost, or to notch out bothersome frequencies for particular sources. For full mix ambience/mastering presets, use the EQ to cut most of all LF input, which yields added ambience without mucking up the mix. This is a powerful EQ, so experiment!

- Try different diffusion settings for your preset (the slider on the right of the Reverberation panel). Diffusion radically alters the reverberation sound and is source dependent. Higher diffusion values yield a fuller sound, good for percussive sounds; lower diffusion values yield a less dense sound, good for vocals, synths, etcetera.
- When monitoring your preset, try switching from Dry solo, Wet solo, and a useful mix. Solo the reflections and reverberation, and disable/enable EQ. Try different sources and mixes. Reach for the headphones every now and then. In general just keep things moving, as ear fatigue can be particularly deceiving with reverb sounds.
- The Positioning panel is generally only needed for automation. Ignore these settings for preset design unless going for a panning effect or monitoring real-world use.
- Often when you've got a really great preset designed, all it takes are a few subtle changes to make a number of other great presets.

**Tips for designing a natural environment sound:**

- Make timing proportional. As the size of the simulated environment increases, the length of the pre-delay for the EF, LF, and LF tail should increase proportionally. Typically, ER and LF pre-delay should be not too far apart, with LF starting shortly after ER.
- Place the ER timing preceding/leading into the LF
- ER amplitude naturally decays. Slope the amplitude down from left to right.
- Use ER filtering, as this improves the reverb sound in almost all situations.
- Try a gradual Lf or Hf roll-off (or boost) with the EQ section. The left and right-most EQ bands are shelf filters, which are perfect for this job. The adjacent bands can be used to shape the roll-off.
- Try natural materials and air densities before the unnatural custom or inverse materials and air densities.
- Try adding onset (slope) to the LF, as many environments naturally have an LF onset.

**For additional info:**

- Read [Chapter 30, "RealVerb Pro"](#) (page 250) of this manual.

## CHAPTER 32

# Plate 140

### Overview

Universal Audio “steps up to the plate”, rendering yet another classic tool for the DAW that no mixer should be without: Introducing the Plate 140 Plug-In.

German company EMT made a breakthrough in 1957 with the release of the EMT 140, which utilized a resonating metal plate to create ambience. Nothing is quite like the wonderfully smooth sound of plate reverb that still endures as part of the fabric of modern music. However, plate reverb systems are expensive, bulky, need to be isolated from vibration and maintained regularly—therefore plates are usually found only in major studios.

Universal Audio faithfully recreates that unmistakable sound with the Plate 140 Plug-In. The Plate 140 replicates the sonic signature of three uniquely different EMT 140s found at The Plant Studios in Sausalito. That’s nearly two thousand pounds of sound in one plug-in! We thoughtfully combined the look of various elements from the EMT 140 system into one convenient panel, replicating the original damper controls for decay, and adding additional controls for the convenience of the modern DAW user.

### Plate 140 Screenshot



Figure 104. The UAD Plate 140 plug-in window

## Plate 140 Controls

The Plate 140 interface is an amalgam of controls found at the plate amplifier itself and the remote damper controls, plus a few DAW-friendly controls that we added for your convenience. The GUI incorporates the original look and feel of those controls, and utilizes that look for the DAW-only controls.

**Note:** When adjusting parameters, keyboard shortcuts are available for fine, coarse, and other control methods. See “Shortcuts” on page 79.

## Reverb



Plate reverb systems are extremely simple: A remote damper setting, and a high pass or shelf filter found at the plate itself. Additional manipulation is often used, including reverb return equalization, which is typically achieved at the console. Predelay is/was often achieved when necessary with tape delay, sending the return to a tape deck. Different tape speeds allowed different pre-delay amount.

The original damper controls are remote control devices, usually found somewhere near the control room for quick access. Our hybrid panel combines three remotes into the panel, with a switch to select each of the three available systems.

**Note:** The reverb controls (select and time) are completely independent from the other plug-in controls (EQ, Predelay, Width, etcetera).

### Plate Select Switch



Three plate models (algorithms) are available for reverb processing. This switch specifies which plate will be active.

Each setting is a model of a completely separate and unique plate system. Three 140's for the price of one!

**Note:** You can also switch the active plate by clicking the A, B, or C letters above the Plate Select switch and the Reverb Time meters.

## Reverb Time Meters



The Reverb Time Meters display the reverb time of plates A, B, and C in seconds. The meter for the active plate model (as specified by the Plate Select switch) is illuminated.

**Note:** The meter value can be changed by dragging its “needle” in addition to its corresponding Damper controls.

## Damper Controls (Reverb Time)



The Damper Controls change the reverb time for each plate. The range is from 0.5 to 5.5 seconds, in intervals of 0.1 sec.

Click the buttons to increment or decrement the reverb time.

## EQ



This group of parameters contain the controls for Plate 140’s onboard utility equalizer. It is a two band (low and high) shelving EQ that uses analog-sounding algorithms for great tonal shaping options.

The EQ section is independent from the reverb algorithms and the low cut filter on the modeled plate systems. See [“Cut Filter” on page 289](#).

The frequency parameters specify the center of the transition band, which is defined as the frequency at which the level in dB is the midpoint between DC and the band edge level.

**Note:** There is one EQ per plug-in instance. Each plate model (A, B, C) within a preset cannot have unique EQ values.

## EQ Enable Switch

The Plate 140 equalizer can be disabled with the EQ Enable switch. UAD DSP usage is not increased when EQ is enabled.

**Low Frequency Knob**

This parameter specifies the low shelving band transition frequency to be boosted or attenuated by the low band Gain setting. The range is 20Hz to 2kHz.

Because this is a shelving EQ, all frequencies below this setting will be affected by the low band Gain value.

**Low Gain Knob**

This parameter determines the amount by which the transition frequency setting for the low band is boosted or attenuated. The available range is  $\pm 12$ dB, in increments of 0.5dB (fine control) or 1.0dB (coarse control).

**High Frequency Knob**

This parameter determines the high shelving band transition frequency to be boosted or attenuated by the high band Gain setting. The range is 200Hz to 20kHz.

Because this is a shelving EQ, all frequencies above this setting will be affected by the high band Gain value.

**High Gain Knob**

This parameter determines the amount by which the frequency setting for the high band is boosted or attenuated. The available range is  $\pm 12$ dB, in increments of 0.5dB (fine control) or 1.0dB (coarse control).

**Output VU Meter**



The vintage-style VU Meter represents the plug-in output level. It is active when the Power switch is on, and slowly returns to zero when Power is switched off.

**Predelay Knob**



The amount of time between the dry signal and the onset of the reverb is controlled with this knob. The range is 0.0 to 250 milliseconds.

This control uses a logarithmic scale to provide increased resolution when selecting lower values. When the knob is in the 12 o'clock position, the value is 50 milliseconds.

**Width Knob**



This control narrows the stereo image of Plate 140. The range is from 0 – 100%. At a value of zero, Plate 140 returns a monophonic reverb. At 100%, the stereo reverb field is as wide as possible.

## Mix Knob



The Mix control determines the balance between the original and the processed signal. The range is from Dry (0%, unprocessed) to Wet (100%, processed signal only).

This control uses a logarithmic scale to provide increased resolution when selecting lower values. When the knob is in the 12 o'clock position, the value is 15%.

***Note:** If Wet Solo is active, adjusting this knob will have no affect.*

## Wet Solo Button



The Wet Solo button puts Plate 140 into "100% Wet" mode. When Wet Solo is on, it is the equivalent of setting the Mix knob value to 100% wet.

Wet Solo defaults to On, which is optimal when using Plate 140 in the "classic" reverb configuration (placed on an effect group/bus that is configured for use with channel sends). When Plate 140 is used on a channel insert, this control should be deactivated.

***Note:** Wet Solo is a global (per Plate 140 plug-in instance) control. Its value is not saved within presets.*

## Power Switch



This toggle switch enables or disables Plate 140. You can use it to compare the processed settings to that of the original signal, or to bypass the plug-in which reduces (but not eliminates) the UAD DSP load.

## Power Lamp

The red power indicator glows brighter when the plug-in is enabled by the Power switch.

## Hidden Controls

Several controls exist that are not available within the Graphical User Interface. They can only be viewed or modified in automation mode or “controls” mode.



Figure 105. Plate 140 in Controls mode

**Note:** *Not all host applications support automation and/or controls mode.*

## Accessing

Each host application has its own particular operating methods. Consult the host application documentation for specific instructions on accessing automation parameters and controls mode.

If the host application does not support automation or controls mode, use the factory presets as starting points for your own custom presets.



## Cut Filter

The Cut Filter is an equalizer that is used to reduce low frequency content in the reverb. On hardware plate systems, the cut filter setting is rarely modified because it is found at the plate amplifier unit itself and is not easily accessed from the control room.

**Note:** *There is one Cut Filter per plug-in instance. Each plate model (A, B, C) within a preset cannot have a unique Cut Filter value.*

Plate 140 contains two types of cut filters: original EMT electronics, and Martech electronics which was/is a common plate system retrofit.

In the modeled source units at The Plant, plates A and B use the EMT electronics while Plate C utilizes the Martech electronics. In Plate 140, you can use either cut type with any of the three available plates.

Off  
M 90Hz  
M 125Hz  
M 180Hz  
M 250Hz  
M 270Hz  
M 360Hz  
E -4dB  
E -10dB  
E -16dB

The values prefaced with an “E” designate the original electronics model. This is a cut filter centered at 80Hz, with three available levels of attenuation: -4dB, -10dB, and -16dB.

The values prefaced with an “M” designate the Martech electronics model. This is a shelf filter (all frequencies below the frequency are reduced). Six shelving frequencies are available: 90Hz, 125Hz, 180Hz, 250Hz, 270Hz, and 360Hz.

## Balance Control

This stereo control balances the level between the left and right channels of the reverb return. Rotating the knob to the left attenuates the right channel, and vice versa (it is not a mono pan control).

## Modulation

The Plate 140 reverb time can be modulated by a low frequency oscillator using rate and depth controls. The effect is subtle but it can increase dispersion and reduce ringing on some source material, such as loud signals with sudden endings and percussive content.

## Mod Rate

Mod Rate controls the rate of reverb time modulation. The available range is from 0.01Hz to 1.0Hz.

## Mod Depth

This parameter controls the amount of reverb time modulation. The available range is from 0 – 10 cents.

**Note:** *The Plate 140 distills 1800+ pounds of sound into a single plug-in. Exercise caution when lifting.*

# Precision Maximizer

### Overview

The Precision Maximizer is a dynamic impact processor that uniquely enhances the apparent loudness, warmth, and presence of individual tracks or program material without appreciably reducing dynamic range or peak level control. Significant audio improvements can be achieved without the fatiguing artifacts typically associated with traditional dynamic processors.

The plug-in uses a proprietary soft-saturation process that maximizes signal energy while minimizing undesirable distortion and aliasing. A wide variety of sounds are available using relatively few controls. The primary sonic parameter is the Shape control, which can range from simply increasing the apparent loudness at lower settings, to dramatically improved clarity, punch, and “musical” tube-like distortion at higher values.

The nature of the source material, as well as the input levels to the processor, also greatly affect the sonic character at the output. The Limit function and 3-band mode enable further manipulation of signal levels for additional creative options.

**Note:** See “Operating Tips” on page 295 for practical usage information.

### Signal Flow

The input signal first passes through the Input control (page 291), then the Input Meter (page 291), before arriving at the Bands divider (page 292). After being optionally divided by the Bands parameter, the signal is then split into the dry path and the wet saturation path. The saturation path is processed by the Shape control (page 292), then the wet and dry signals are combined with the Mix control (page 293). Finally, the mixed signal is processed by the Limit control (page 293) before being passed to the Output control (page 294) and Output Meter (page 294).

## Precision Maximizer Screenshot



Figure 106. The Precision Maximizer plug-in window

## Precision Maximizer Controls

Control knobs for the Precision Maximizer behave the same way as all UAD plug-ins. Input, Shape, Mix, and Output values can be modified with text entry. See [“Text Entry” on page 79](#) for more information.

### Input Meter



The stereo peak Input Meter displays the signal level at the input of the processor, after the Input control.

0dB represents digital full scale (0dBFS). Precision Maximizer can utilize input signals up to +6dB at the input before input clipping occurs.

The displayed range is from -40dB to +6dB.

### Input



The Input Level knob controls the signal level that is input to the plug-in. Increasing the input will generally result in more processing (depending on the settings of the other parameters).

By increasing the Input knob, input levels higher than 0dBFS (up to +6dBFS) within the plug-in can be processed. This can increase the distortion characteristic at the output, particularly when the Limit function ([“Limit” on page 293](#)) is engaged.

The available range is  $\pm 12$ dB. A good starting point for sonic experimentation is to set the input level so the input peaks occur around 0dB, then adjust the other controls to taste.

## Shape



The Shape knob is the primary saturation control for the Maximizer effect. It contours the harmonic content and apparent dynamic range of the processor by changing the small-signal gain of the saturator. The available range is 0–100%.

At lower settings, apparent loudness is not as dramatic but harmonic processing still occurs, producing a richer sound with minimal reduction of dynamic range. As Shape is increased, the sound becomes more saturated with “sonically pleasing” distortion and perceived loudness, punch, and clarity.

Shape values between 0-50% will make the effect more subtle, but a richer sound is still obtained. Lower Shape values accentuate louder peaks, which can sound great on percussive instruments. Solo instruments can also benefit from lower Shape values by taming the peaks while maintaining dynamic range.

As Shape is increased beyond 50%, presence, excitement, and harmonic coloration can be dramatic, yet still highly musical and without the dynamic squashing of typical limiters.

The most natural warmth and tube-like distortion is obtained with Shape at 50%. This setting generates the lowest amount of higher order harmonics and most closely emulates characteristic tube qualities.

## Bands



Precision Maximizer can operate in one-band or three-band mode. In one-band mode, all frequencies are processed equally. In three-band mode, the frequency spectrum is split into three separate bands before maximizing is applied.

One-band mode is the normal setting for general usage. In this mode, more dramatic results can often be obtained because more saturation effect is possible before the output is clipped. At higher levels of distortion, the phase of the harmonics are also better retained in this mode, which usually produces a more desirable sound quality.

Higher levels of perceived loudness may be obtained in three-band mode, especially if the frequency spectrum of the source material is not balanced. In this mode, certain settings can produce higher output levels than input levels (and potential clipping), so it may be necessary to compensate by reducing the input/output levels, and/or engaging the Limit control.

The crossover frequencies in three-band mode are 200Hz and 2.45kHz.

Click the Bands button to change the mode. Alternately, you can click+hold the LED area and drag like a slider to change the value.

**Note:** UAD DSP usage is increased when three-band mode is active.

## Limit



The Limit function provides a second stage of soft-saturation just before the output control for the plug-in. It prevents digital “overs” by protecting the plug-in output from exceeding 0dBFS. Limit enters into clipping range gradually instead of hard-clipping at 0dB.

The Limit function has the same saturation form as the Shape parameter, but the effect is milder. Limit is especially useful for three-band mode, where output peaks over 0dB (and clipping) can occur. However, great results can also be obtained in one-band mode when Limit is engaged.

If Limit is used to reduce levels by a significant amount, it is usually best to have Mix set to 100% in order to minimize audio artifacts (aliasing).

Click the Limit button to engage Limit. Alternately, you can click+hold the LED area and drag like a slider to change the value.

**Note:** UAD DSP usage is slightly decreased when Limit mode is inactive.

## Mix



The Mix knob is a mix control for the plug-in. Mix determines the balance between the original and the processed signal.

The range is from 0% (no processing) to 100% (wet, processed signal only).

Note that when Mix is at 0%, the signal is still processed by the Limit control if it is enabled, and by the band splitter when in three-band mode. For a true bypass, the Power switch should be used.

## Output



The Output knob controls the signal level that is output from the plug-in. The available range is  $-12\text{dB}$  to  $0\text{dB}$ .

Note that when Limit is not engaged, it is possible for the output level to exceed  $0\text{dB}$ . In this case, Output can be lowered to eliminate any associated clipping.

When Precision Maximizer is used for CD mastering and it is the last processor in the signal chain, the recommended Output value is  $-0.10\text{dB}$

## Output Meter



The stereo peak Output Meter displays the signal level at the output of the plug-in. The displayed range is from  $-40\text{dB}$  to  $0\text{dB}$ .

The very top segment of the Output Meter is a clip LED (one each for the left and right channels) which illuminates when the signal exceeds  $0\text{dB}$ . The clip segment are held for three seconds before resetting.

**Note:** The Limit function prevents the output signal from exceeding  $0\text{dB}$ . Therefore, the clip LED's will only illuminate if Limit is off.

## Power

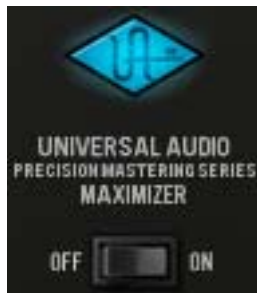

The Power switch determines whether the plug-in is active. This is useful for comparing the processed settings to the original signal or bypassing the plug-in to reduce the UAD DSP load.

Toggle the switch to change the Power state; the UA logo is illuminated in blue when the plug-in is active.

**Note:** You can click-hold the power switch then drag it like a slider to quickly compare the enabled/disabled state.

## Operating Tips

- As a starting point for general loudness enhancement, set Precision Maximizer to one-band mode with Limit engaged, with Mix at 100% and Shape at 50%. Then set Input so signals peak at around 0dB on the Input Meters. These settings offer good results under most conditions, producing more presence with a warmer sound and enhanced detail (especially with lower frequencies), while retaining the apparent dynamic range of the original signal.
- The most natural warmth and tube-style distortion can be obtained with Shape at 50% in one-band mode, with Limit off, and signal peaks just touching 0dB at the input. Shape at 50% delivers the lowest amount of higher order harmonics and most closely emulates a tube characteristic.
- More overdrive may be obtained by disengaging the Limit function. Up to +6dB of additional headroom is available before clipping occurs when Limit is off. This can cause clipping at the output, so reduce the Input and/or Output control to compensate if necessary.
- Input clipping can dramatically change the distortion characteristic, and may yield significantly different results in one-band versus three-band mode.
- Generally speaking, the input should be set as high as possible before undesirable sound quality is obtained.
- For optimum results (especially when Limit is off) ensure the source signal is not clipped before it arrives at the Precision Maximizer input.
- Output clipping can be completely avoided by enabling Limit.
- One-band mode is generally recommended for program material.
- Set Mix at 100% in order to hear the full affect of the Maximizer process. Reduce Mix when blending in the original signal is desired.
- Changing the order of plug-ins in the signal path can have a dramatic affect on Precision Maximizer results.
- Sonic experimentation is highly encouraged!

## Precision Maximizer Latency

The Precision Maximizer uses an internal upsampling technique to facilitate its amazing sonic quality. This upsampling results in a slightly larger latency than other UAD plug-ins. You may enter a value in the “Samples” parameter in DelayComp or TrackAdv to compensate. See “Compensating Upsampled Plug-Ins” on page 95 for more information.

**Note:** *Compensating for Precision Maximizer is not required if the host application supports full plug-in delay compensation throughout the signal path, or when it is used only on the outputs. See “Host PDC Implementation” on page 88.*

## WebZine Article

An interesting article about sonic enhancers can be found in the “Ask The Doctors” article of the Universal Audio May 2007 Webzine (Volume 5, Number 4), published on the internet at:

- <http://www.uaudio.com/webzine/2007/may/index2.html>



## CHAPTER 34

# Precision De-Esser

### Overview

The Precision De-Esser seamlessly and accurately removes sibilance from individual audio tracks or even composite mixes via its intuitive interface and sophisticated yet transparent filter processing.

The Threshold knob dials in the amount of sibilance reduction, while the two-position “Speed” button gives control over the envelope (attack and release) of the detector. The Frequency knob sweeps a continuous target frequency range from 2-16 kHz, allowing repairs on a large range of voices (or even overheads and hi-hats), while the Solo button allows the user to isolate and monitor the target sibilant frequencies. The Width control offers a variable 1/6 to 1 2/3 octave bandpass filter that is perfect for complex program material, adapting technology from the TEC-nominated Precision Multiband. The Width control also switches into a more traditional highpass filter more commonly employed when tailoring individual voices. For even greater transparency, the Split feature gives the user the option to compress only the sibilant range, or may be turned off to compress the entire spectrum for more traditional de-essing.

### Precision De-Esser Screenshot



Figure 107. The Precision De-Esser plug-in window

## Precision De-Esser Controls

Control knobs for the Precision De-Esser behave the same way as all UAD plug-ins. Threshold, Frequency, and Width values can be modified with text entry. See [“Text Entry” on page 79](#) for more information.

### Threshold



Threshold controls the amount of de-essing by defining the signal level at which the processor is activated. Rotate Threshold counter-clockwise for more de-essing.

Signals peaks, as determined by Frequency ([“Frequency” on page 298](#)) and Width ([“Width” on page 299](#)), that exceed the Threshold level are compressed by a ratio of 7:1.

The available range is -40dB to 0dB.

### Speed



Speed determines the response of the sibilance detector. Fast mode will usually make sibilance reduction more obvious. In Slow mode the effect is usually more subtle but can produce a more natural-sounding result. The actual times of the two modes are as follows:

- Fast: Attack = 0.5ms, Release = 30ms.
- Slow: Attack = 2.0ms, Release = 120ms.

Click the Speed button to change the mode. Alternately, you can click+hold the LED area and drag like a slider to change the value.

### Frequency



This control defines the center frequency of the de-esser when in bandpass mode, or the cutoff frequency of the de-esser when in highpass mode. For bandpass use, the value is set to the center of the undesirable frequency range that is to be reduced. For highpass use, the value is set below the frequency range that is to be reduced. Used in conjunction with the Width control ([“Width” on page 299](#)), a broad range of de-essing is possible.

The available range is 2kHz – 16kHz.

### Solo



The Solo button isolates the de-essing sidechain (the signal defined by Frequency and Width). Solo makes it easier to hear the problem frequencies to be attenuated.

Click the button to active Solo mode. The button is red when Solo is active.

**Note:** When Solo is active, changes to the Threshold and Split controls cannot be heard.

## Width



Width controls the bandwidth of the de-essing sidechain when in bandpass mode. Bandpass mode is active when the control is in any position except fully clockwise.

Smaller values have a narrower bandwidth, causing a tighter, more focused de-essing effect. Higher values have wider bandwidth, for de-essing when undesirable frequency ranges are broader.

When Width is rotated fully clockwise, High Pass mode is activated. In High Pass mode, Frequency (["Frequency" on page 298](#)) defines the cutoff frequency of the high pass filter (instead of the center frequency of the bandpass filter). High Pass mode is useful when you want to attenuate all frequencies above the cutoff frequency.

The available range is 0.15 (about 1/6 octave) to 1.61 (about 1 2/3 octaves), plus High Pass mode.

**Note:** UAD DSP usage is slightly decreased when Precision De-Esser is in High Pass mode (versus bandpass mode).

## Split



Split determines if attenuation (compression) is applied to the sidechain signal only, or to the entire audio signal.

In normal use Split should be enabled, causing only the "ess" spectrum as defined by Frequency and Width (i.e., the sidechain), to be attenuated. This provides the most precise de-essing control.

Split can be disabled, which causes the entire input signal to be attenuated (instead of just the "ess" sidechain) which results in more traditional compression. However, the sidechain still controls attenuation when Split is off.

Click the Split button to change the mode. Alternately, you can click+hold the LED area and drag like a slider to change the value.

**Note:** UAD DSP usage is slightly decreased when Split is disabled.

## Gain Reduction



The Gain Reduction meter provides a visual indication of how much attenuation (compression) is occurring. Signal peaks are held for 3 seconds before resetting.

When Split is on, the amount of sidechain attenuation is displayed. When Split is off, it displays the attenuation of the entire signal.

## Power



The Power switch determines whether the plug-in is active. This is useful for comparing the processed settings to the original signal or bypassing the plug-in to reduce the UAD DSP load.

Toggle the switch to change the Power state; the UA logo is illuminated in blue when the plug-in is active.

**Note:** You can click-hold the power switch then drag it like a slider to quickly compare the enabled/disabled state.

## Operating Tips

- For taming sibilance for a full mix/mastering, best results will usually be obtained by enabling Highpass and Split modes.
- Generally, female “ess” and “shh” sounds vary more in frequency than those of males. Due to this situation, you may find that using the sidechain filter in Highpass mode (or Bandpass mode with a large width) may be more responsive.
- Over de-essing can degrade the natural sound of a vocal.

# Precision Enhancer kHz

### Overview

The Precision Enhancer kHz is a sophisticated tool with a simple control set, primarily designed to bring dull or poorly recorded tracks to life. However, with five distinct enhancement modes, the Precision Enhancer kHz will find uses on virtually any source. It can be used to minimally massage the middle and upper frequencies of a mix, or drastically alter the presence or dynamics of individual tracks or groups. Unlike other enhancers that function by frequency delay or filtered clipping, the Precision Enhancer kHz works on specialized techniques of equalization and dynamic expansion that can be used as a highly versatile effect.

The five Modes (A, B, C, D and All) present various control configurations to support the widest array of source material. With Modes A and B, the filtered audio is mixed in with the dry signal according to the Sensitivity control. For Modes C, D and All, audio is passed through a unique upwards expander where the expanded audio is then filtered before being mixed with the dry signal. For these modes, Sensitivity is used as a fader on the way into the expander. The release can be adjusted to either Fast or Slow via the Speed button, giving a greater range of dynamic/frequency enhancement. For Mode C, the sweepable filter applied to the expander's output is identical to the filter used with Mode A. For Mode D and All, the expander's output is passed to a set of filters in parallel. Finally, the Precision Enhancer kHz includes control over the final output level with metering to compensate for gain changes created by the effect.

## Precision Enhancer kHz Screenshot



Figure 108. The Precision Enhancer kHz plug-in window

## Precision Enhancer kHz Controls

Control knobs for the Precision Enhancer kHz behave the same way as with all UAD plug-ins. Threshold, Frequency, and Output values can be modified with text entry. See [“Text Entry” on page 79](#) for more information.

### Sensitivity Knob



The Sensitivity Knob controls the amount of processing that occurs in the plug-in. The available range is from 0.00 to 100.0%.

Technically speaking, Sensitivity scales the input to the enhancer. Increasing this parameter makes the enhancer have a higher amplitude output for a given input level. Increasing Sensitivity increases the overall enhancement effect.

**Note:** The signal level at the plug-in input will interact with the Sensitivity control.

### Sensitivity Meter

The Sensitivity Meter indicates the amount of signal processing that is occurring. More illuminated blue segments indicate more signal enhancement.

### Mode



The Mode control determines the type of enhancement that will be applied to the signal. The active Mode can be selected by clicking the Mode button repeatedly to rotate through the Modes, or by clicking each Mode letter or LED. “All” mode can also be selected by shift+clicking Mode letters or LEDs.

#### Mode A

Mode A enhances the high frequency content statically. Input dynamics have no effect on the enhancement process.

#### Mode B

Mode B is optimized for vocal range content. The Frequency parameter is disabled in this mode.

### Mode C

Mode C dynamically enhances the high frequency content. The enhancement amount is increased as the input signal level increases.

### Mode D

Mode D dynamically enhances both high and low frequency content. The enhancement amount is increased as the input signal level increases. The Frequency parameter is disabled in this mode.

### All Mode

All Mode is similar to Mode D in that it dynamically enhances both high and low frequency content, but the effected frequency spectrums are even broader. The enhancement amount is increased as the input signal level increases. The Frequency parameter is disabled in this mode.

## Speed



The Speed parameter defines the attack and release characteristic of the enhancement process.

### Fast

In Fast mode, the enhancement processor has a quick response time of 30ms, which yields a more percussive “bite” and/or a more aggressive sound.

### Slow

Slow mode has a slower response time of 180ms which can deliver a smoother sound overall.

## Frequency



The Frequency parameter defines the cutoff frequency for the enhancement process in Mode A and Mode C. Frequencies above this value are enhanced by the processor. The available range is 1.00kHz to 10.0kHz.

**Note:** Frequency is disabled in Modes B/D/All.

## Output



Output controls the signal level that is output from the plug-in. The available range is -20dB to 0dB.

Generally speaking, adjust the Output control after the desired amount of processing is achieved with the Sensitivity and Frequency controls. Output does not affect the amount of enhancement processing, nor does it have any effect when the plug-in is disabled.

### Output Meter

The Output Meter displays the signal level at the output of the plug-in.

When the plug-in is disabled with the plug-in Power switch (but not the host plug-in enable switch), the output meters still function.

### Power



The Power switch determines whether the plug-in is active. This is useful for comparing the processed settings to the original signal or bypassing the plug-in to reduce the UAD DSP load.

Toggle the switch or click the UA logo to change the Power state; the UA logo is illuminated in blue when the plug-in is active.

**Note:** You can click-hold the power switch then drag it like a slider to quickly compare the enabled/disabled state.



# SPL Transient Designer

## Overview

Universal Audio has partnered with German company Sound Performance Lab (SPL) to bring you the Transient Designer, with its unique and compelling Differential Envelope Technology for shaping the dynamic response of a sound. Only two simple audio controls are required to allow you to effortlessly reshape the attack and sustain characteristics. SPL was the first company to design an analog solution for level-independent shaping of envelopes, allowing transients to be accelerated or slowed down and sustain prolonged or shortened.

You can shorten or lengthen the attack and sustain of percussive signals such as kick drum, snare or toms, easily take the bleed from open mics, or expand the room sound of overheads. The Transient Designer's magic can be applied to virtually any other signal as well: Amplify or reduce the picking sound of an acoustic guitar, hold the sound of strings longer, or reduce the reverb time of a choir.

## SPL Transient Designer Screenshot



Figure 109. The SPL Transient Designer plug-in window

## SPL Transient Designer Controls

Containing only two primary controls, the UAD SPL Transient Designer is extremely simple to operate. The technology behind the processor isn't as important as how it sounds. However, for those who desire a deeper understanding of the process, a deeper explanation of the underlying technology is presented at the end of this chapter (see [“Technology” on page 312](#)).

### Attack



Attack enables amplification or attenuation of the attack of a signal by up to  $\pm 15$ dB.

The Attack control circuitry uses two envelope generators. One follows the shape of the original curve and adapts perfectly to the dynamic gradient. The second envelope generator produces an envelope with a slower attack. From the difference of both envelopes the VCA control voltage is derived. Positive Attack values emphasize attack events; negative values smooth out the attack envelopes of sound events.

For more information, see [“The ATTACK Control Circuitry” on page 312](#))

### Sustain



Sustain enables amplification or attenuation of the sustain of a signal by up to  $\pm 24$ dB.

The Sustain control circuitry also uses two envelope generators. One follows the shape of the original curve and adapts perfectly to the dynamic gradient. The second envelope generator produces an envelope with a longer sustain. From the difference of both envelopes the VCA control voltage is derived. The gradient of the control voltage matches the time flow of the original signal. Positive Sustain values lengthen the sustain; negative values shorten the sustain.

For more information, see [“The SUSTAIN Control Circuitry” on page 314](#).

### Gain



Gain controls the signal level that is output from the plug-in. The available range is from -20dB to +6dB. The default value is 0dB.

## Signal



This 4-stage “LED” indicates the presence of audio signals at the input of the plug-in. When the input signal is below -25dB, the indicator is off. At -25dB to -19dB, the indicator glows slightly. At -18dB to -10dB, it lights with medium intensity. At -9dB to 0dB, it shines brightly.

## Overload



The Overload “LED” illuminates when the signal level at the output of the plug-in reaches 0dBFS. The indicator matches the behavior of the original hardware unit. However, in the software plug-in version, the output can be “overloaded” without causing distortion.

## Link

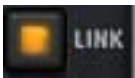

Link indicates when stereo operation is active. It illuminates when used in a stereo-in/stereo-out or mono-in/stereo out configuration. It does not illuminate when used in a mono-in/mono-out configuration.

**Note:** *Link is an indicator only; it does not control any plug-in parameter.*

## On/Power



The On and Power switches determine whether the plug-in is active. Click the On or Power switches to change the state. On and Power illuminate when the plug-in is active.

When the plug-in is inactive, processing is disabled and UAD DSP usage is reduced.

**Note:** *The On and Power switches perform the exact same function.*

## WebZine Article

An interesting article about the SPL Transient Designer is available in the “Ask The Doctors” section of our November 2007 WebZine:

<http://www.uaudio.com/webzine/2007/november/index2.html>

## Acknowledgement

In addition to creating an amazing piece of hardware, Sound Performance Lab also wrote an extensive user manual for the Transient Designer. Because Universal Audio has full license to make use of the Transient Designer technology, SPL has graciously authorized us to use their documentation as well.

The remainder of this chapter is excerpted from the SPL Transient Designer (RackPack) User Manual, and is used with kind permission from SPL. All copyrights are retained by SPL.

## Applications

The SPL Transient Designer is ideally suited for use in professional recording, in project or home studios and sound reinforcement applications.

For the first time you can manipulate and control the attack and sustain characteristics of a signal regardless of level in the most intuitive and simple way. Usually equalizers are used to separate instruments in a mix – the tonal aspect of the signal is considered, but not the temporal aspect.

The Transient Designer opens this further dimension in signal processing. By manipulating the attack and sustain curves of a sound event, the mix can be made to sound more transparent. Instruments can be mixed at lower levels while still maintaining their positions in the mix—but occupying less space.

During a remix or in general after micing you can arrange new positions of instruments. Reduce ATTACK and increase SUSTAIN to move signals back into the mix that are too present. Additionally the FX parts of too dry signals are strengthened.

Applied to single instruments or loops the Transient Designer allows you to create entirely new sounds and/or effects.

The following examples are given as suggestions and examples. The described procedures with specific instruments can of course be transferred to others that are not mentioned here.

### Drums & Percussions

Processing drum and percussion sounds is probably the Transient Designer's most typical range of application; both from samples to live drum sets

- Emphasize the attack of a kick drum or a loop to increase the power and presence in the mix.

- Shorten the sustain period of a snare or a reverb tail in a very musical way to obtain more transparency in the mix.
- When recording a live drum set, shorten the toms or overheads without physically damping them. Usual efforts to damp and mike are reduced remarkably. Since muffling of any drum also changes the dynamic response, the Transient Designer opens up a whole new soundscape.
- Micing live drums is considerably faster and easier because you can correct the apparent “distance” of the microphone by simply varying the ATTACK and SUSTAIN values.
- The Transient Designer is a perfect alternative to noise gates in live drum micing. Adaptively reacting to the duration of the original signal, the sustain is shortened more musically than with fixed release times and a drumset is freed from any crosstalk quickly and effectively.
- Create unusual dynamic effects including new and interesting pan effects. For example, patch a mono loop through two channels of the Transient Designer and pan fully left and right in the mix. Process the left channel with increased ATTACK and reduced SUSTAIN while you adjust the right channel the opposite way and you get very special stereo loop sounds. You have to try this to appreciate what it sounds like, but expect to hear a lot of unusual stereo movement.
- Enjoy an amazingly simple integration of drum sounds into a mix. If the acoustic level of a snare is expanded to approximately +4 dB by increasing the attack value, the effective increase of peak levels in the overall mix is merely about 0.5 dB to 1 dB.

### **Drums: Ambience**

If your drums happen to sound as if the room mics have been placed in a shoe closet, the Transient Designer can immediately turn that sound into the ambience of an empty warehouse. Just send the stereo room mics through the Transient Designer and crank the ATTACK control to emphasize the first wave.

Now slowly increase SUSTAIN values to bring up an “all-buttons-in-1176-sound” room tone—but without pumping cymbals. For a solid and driving rhythm track just fine-tune the SUSTAIN control to make sure that the room mic envelope ends more or less exactly on the desired upbeat or downbeat.

## Guitars

Use the Transient Designer on guitars to soften the sound by lowering the ATTACK. Increase ATTACK for in-the-face sounds, which is very useful and works particularly well for picking guitars. Or blow life and juice into quietly played guitar parts.

Distorted guitars usually are very compressed, thus not very dynamic. Simply increase the ATTACK to get a clearer sound with more precision and better intonation despite any distortion.

Heavy distortion also leads to very long sustain. The sound tends to become mushy; simply reduce SUSTAIN to change that. If you, however, want to create soaring guitar solos that would make even David Gilmour blush, just crank up the SUSTAIN control to the max and there you go.

With miced acoustic guitars you can emphasize the room sound by turning up SUSTAIN. If you want the guitars to sound more intimate and with less ambience, simply reduce SUSTAIN.

## Bass: Staccato vs. Legato

Speaking of bass: Imagine a too sluggishly played bass track... you may not have to re-record it: Reduce the SUSTAIN until you can hear clear gaps between the downbeats—the legato will turn into a nice staccato, driving the rhythm-section forward.

## The Re-Invention Of Reverb

Always and everywhere the same reverb presets – boring, aren't they? Try sending the output of your reverb through the Transient Designer. Now crank the ATTACK control to the max and reduce SUSTAIN to a bare minimum. The intensity of the reverb is now much higher in the beginning while the reverb time is reduced.

The opposite can be just as intriguing: manipulate a reverb pattern so that it takes on a pyramidal slope. Turn the ATTACK all the way to the left and SUSTAIN all the way to the right. Now the beginning of the reverb is strongly reduced whereas the sustain blossoms and seems almost endless (obviously that will only happen if the decay of the reverb in the actual reverb device has been set to a sufficient value—a signal must always be present as long as the sustain time lasts.

You can also create a reverb effect that moves from one channel to the other. Reverb presets with a long decay or a long pre-delay and especially those that have flamboyant reflections set to appear after the beginning of the diffuse reverberation tail are predestined for that. Insert the left and the right

channels of the reverb return through two separate Transient Designer instances. Turn the ATTACK fully right on one instance and reduce SUSTAIN slightly (about -1.5 dB). On the other instance turn the ATTACK fully left and the SUSTAIN to the 3-o'clock position (about +12 dB).

These settings preserve the original complexity of the reflections in the reverb but the maximum intensity of the effect will move from the left to the right in the mix while the reverb will maintain its presence in both channels. You can make this effect even more dramatic by setting all controls to their most extreme positions, but you run the danger of ending up with a lopsided effect that appears out of balance.

### **Backings**

A common problem especially with tracks that are recorded and mixed in different studios: Backings lack of ambience, and finding a reverb that “matches” takes time... so simply emphasize the original ambience by turning up the Transient Designer’s SUSTAIN control.

And the opposite problem, too much ambience, is similarly simply solved with the opposite processing —just reduce SUSTAIN.

### **Keyboards & Sampler**

Sounds in keyboards and samples are usually highly compressed and maintain only little of natural dynamics. Increase the ATTACK values to re-gain a more natural response characteristic. The sounds occupy less space in the mix and appear more identifiable even at lower volumes.

### **Post Production**

When dealing with overdubs in movies you can easily add more punch and definition to effect sounds from any sample library.

The same applies to outdoor recordings that suffer from poor microphone positioning—simply optimize them afterwards.

### **Mastering**

Like with any good thing, you also have to know where not to use it. For example, using a Transient Designer in mastering is not recommended, as it is rarely a good idea to treat a whole mix at once. Instead, treat individual elements within the mix.

## Technology

Of course you don't have to know how the Transient Designer works in order to use it. However, since it offers a completely novel signal processing, nothing shall be concealed from the more curious users.

### Differential Envelope Technology (DET)

SPL's DET is capable of level-independent envelope processing and thus makes any threshold settings unnecessary. Two envelopes are generated and then compared. From the difference of both envelopes the VCA control voltage is derived. The DET ensures that both low and loud signals (pianissimo to fortissimo) are treated the same way.

Both ATTACK and SUSTAIN control circuitries operate simultaneously and don't affect each other.

### The ATTACK Control Circuitry

The ATTACK control circuitry uses two envelope generators. The first one generates a voltage (Env 1) that follows the original waveform. The second envelope generator creates the envelope Env 2 with a slower attack envelope.

Figure 110 on page 312 illustrates the original curve and the two created envelopes that control the ATTACK processing. Envelope generator Env 1 follows the original waveform. Env 2 is generated with reduced attack.

**Diagram 1: Generated Envelopes (Attack)**

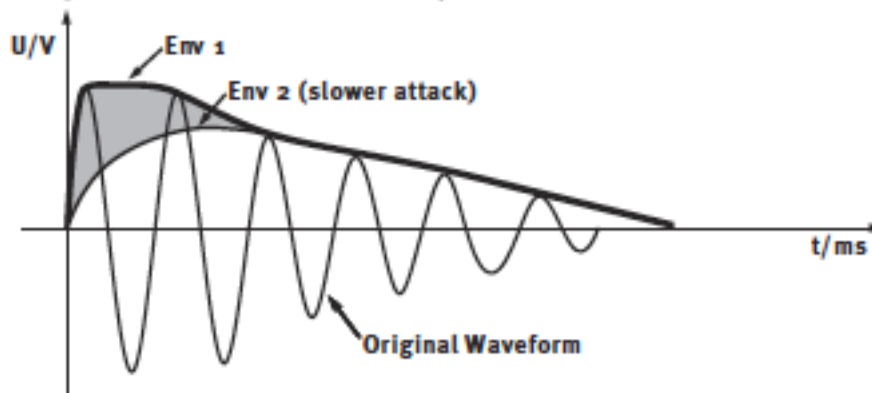

Figure 110. SPL Transient Designer Attack Envelopes



Figure 111 on page 313 shows the difference between Env 1 and Env 2 that defines the control voltage of the VCA. The shaded area marks the difference between Env 1 and Env 2 that controls the control voltage of the VCA. The amplitude of the attack is increased if positive ATTACK values are set. Negative ATTACK values reduce the level of the attack transient.

### Diagram 2: Calculated Control Voltage (Attack)

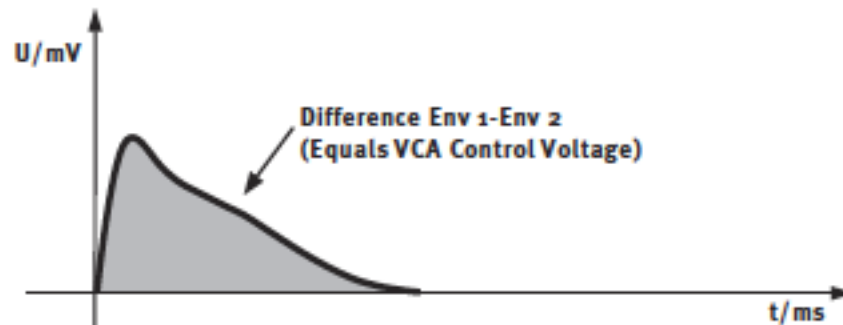

Figure 111. SPL Transient Designer Attack Control Voltage

Figure 112 on page 313 displays the processed waveforms with maximum and minimal ATTACK to compare against the original waveform in diagram 1.

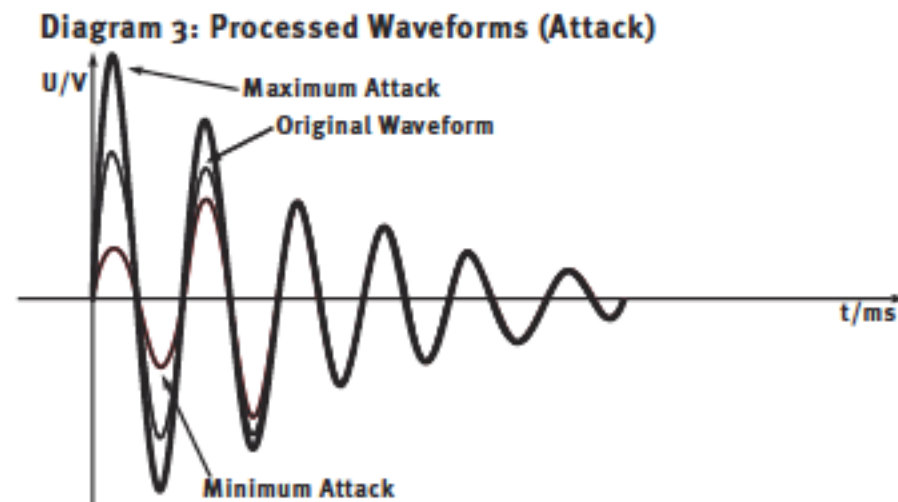

Figure 112. SPL Transient Designer Processed Attack

## The SUSTAIN Control Circuitry

The SUSTAIN control circuitry also plays host to two envelope generators. The envelope tracker Env 3 again follows the original waveform. The envelope generator Env 4 maintains the level of the sustain on the peak-level over a longer period of time. The control voltage of the VCA is again derived from the difference between the two voltages. Sustain amplitude is increased for positive SUSTAIN settings and reduced for negative settings.

Figure 113 on page 314 illustrates the original waveform and the envelope creation to control the SUSTAIN processing. Envelope generator Env 1 follows the original waveform, Env 2 is generated with prolonged sustain.

**Diagram 4: Generated Envelopes (Sustain)**

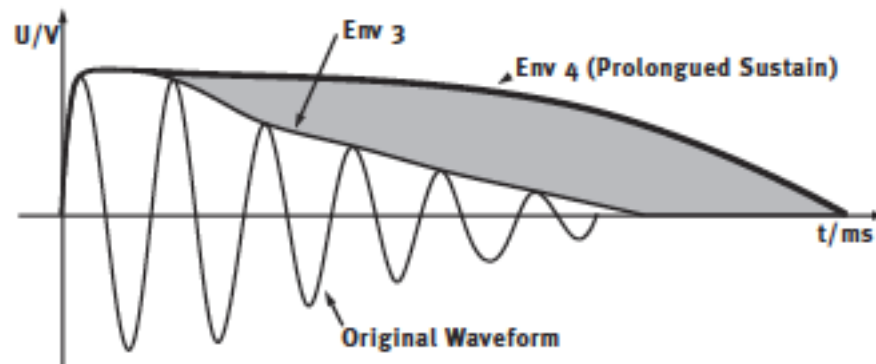

Figure 113. SPL Transient Designer Sustain Envelopes

Figure 114 on page 314 shows the difference between Env 4 and Env 3 that defines the control voltage of the VCA.

**Diagram 5: Calculated Control Voltage (Sustain)**

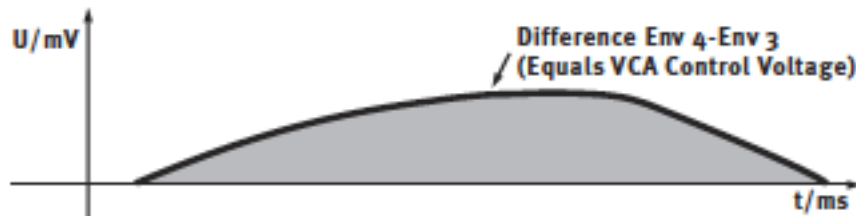

Figure 114. SPL Transient Designer Sustain Control Voltage

Figure 115 on page 315 displays the processed waveforms with maximum and minimal sustain to compare against the original waveform in diagram 4.

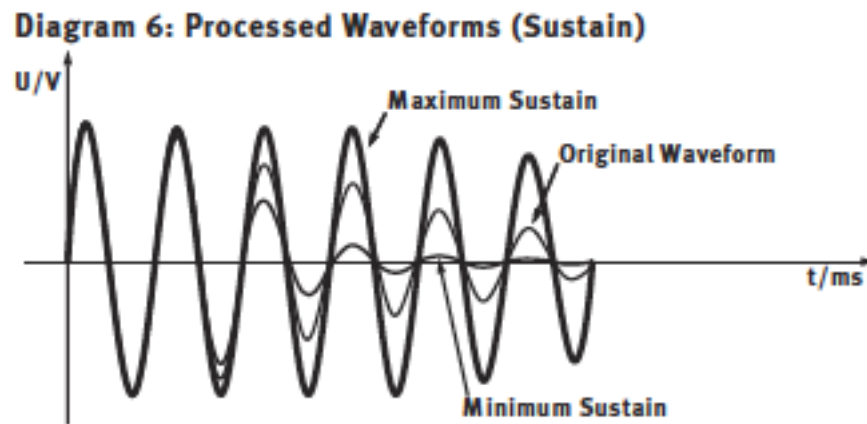

Figure 115. SPL Transient Designer Processed Sustain

SPL Sound Performance Lab® and Transient Designer® are registered trademarks of SPL Electronics, GmbH Germany and are used under license. Portions of this SPL Transient Designer manual section is ©copyright SPL Electronics GmbH Germany and are used under license with kind permission from SPL.

## CHAPTER 37

# Nigel

### Introducing Nigel

Nigel offers the latest generation of guitar processing technology integrated into a complete multi-effects plug-in solution. Utilizing Universal Audio's exclusive component modeling technology, along with some very creative digital design, Nigel delivers a complete palette of guitar tones along with most every effect a guitar player might need, all with minimal latency and no load on your host computer's CPU.

Nigel's Preflex™ advanced guitar amp modeling technology goes well beyond the usual pre-amp/amp/cabinet emulators. In addition to delivering a wide range of highly playable classic amp tones from the "Clean & Warm" California tube sound to more metal soaked "British" tones, a bevy of original timbres simply not possible on any other guitar system can be realized. Preflex also offers variable component-level morphing between any two amp presets, truly bringing creative guitar voicing to the next level.

As with the UAD Powered Plug-Ins CS-1 channel strip, the components of Nigel are also supplied as individual plug-ins for unprecedented DSP and creative efficiency. Each Nigel module includes Universal Audio's proven smoothing algorithm for zipper free automation of all parameters.

Nigel may change the way you think about guitar signal processing. Never before have such exciting, realistic, and extreme guitar sounds been heard from a software plug-in. Enjoy!

## Nigel Screenshot



Figure 116. The Nigel plug-in window

### Nigel Modules

Nigel is comprised of eight modules: Gate/Compressor, Phasor, Mod Filter, Preflex, Cabinet, Trem/Fade, Mod Delay, and Echo. In order to conserve UAD DSP resources when all of the modules are not required simultaneously, some of the Nigel components are also supplied as separate plug-ins.

The following UAD Powered Plug-Ins are part of the complete Nigel package:

- Nigel (all of the modules in one plug-in)
- Preflex (Gate/Compressor + Amp + Cabinet)
- GateComp (Gate/Compressor)
- Phasor
- Mod Filter
- TremFade (Tremolo/Fade)
- TremModEcho (Tremolo/Fade + Mod Delay + Echo)

## Preflex Plug-in

Preflex is the heart of Nigel. All of our plug-ins sound amazing but when it comes to guitar, Preflex really shines. This exciting new guitar processing technology offers truly dynamic sonic possibilities. Multiple equalizers, amp types, and cabinets use sophisticated algorithms to provide analog sound quality never before available in a digital environment.

The Color and Bent controls modify frequency and gain characteristics in interesting and musically useful ways, and realtime component-level morphing between any two amp types is possible.



Figure 117. The Preflex plug-in window

## Preflex Modules

The Preflex plug-in consists of three sub-modules: gate/compressor, amplifier, and cabinet simulator. Controls for each of these sub-modules is described below.

## Gate/Comp Module



Figure 118. The Gate/Comp module

The Gate is the first sub-module in the Preflex signal chain. Its output is passed to the input of the Compressor. The compressor output is then passed to the input of the Amp module within Preflex.

A gate stops the input signal from passing when the signal level drops below a specified threshold value. Gates are generally used to reduce noise levels by eliminating the noise floor when the 'main' signal is not present, but they are also useful for special effects.

The Preflex Gate is optimized for use with guitars. The threshold is dynamic and the gate output has multiple soft knees and dynamic slope, providing a more natural and less choppy sound.

The Compressor reduces the dynamic range of the signal based on the threshold and ratio settings. Guitarists often use compressors to increase perceived sustain on long notes and for special effects. Refer to Chapter 5 for more details on compressor theory and operation. Note that Nigel's compressor sounds different than the CS-1/EX-1 compressor; it sounds "more vintage".

### Gate Level Display

This LED-style VU meter displays the level of the signal at the input of Preflex. For minimum distortion and maximum signal-to-noise, the input level should be as high as possible. The signal is at 0dB just before the red 'LED' is illuminated.

### Gate Off/On Button

Enables or disables the Gate module within Preflex. The Gate is engaged when the button indicator is bright red. Use this switch to compare the Gate settings to that of the original signal or bypass the entire Gate section to reduce UAD DSP load.

**Gate Fast Button** The Fast control reduces the release time of the gate. It has no effect on the attack time. When enabled, the gate will release quickly. On signals that slowly decay and/or have a wide dynamic range, a smoother (less choppy) sound may be obtained with Fast mode turned off.

Fast mode is engaged when the button indicator is bright red. The time values are 50ms when engaged and 170ms when off.

**Gate Threshold Knob** Sets the threshold level for the gate. Any signals that exceed this level are passed into the module. Signals below the threshold level are increasingly attenuated. A Threshold of  $-96\text{dB}$  means the gate is always open. The range is 0dB to  $-96\text{dB}$ .

In typical use it's best to set the gate threshold value to just above the noise floor of the desired signal (so the noise doesn't pass when you are not playing), but below the desired signal input level (so the signal passes as you play).

**Boost Button** The Boost button ([Figure 1 17 on page 3 18](#)) increases the overall signal level within Preflex by 20dB. It is completely independent of the Gate and Compressor On/Off controls and will provide a signal boost even with the Gate and Compressor are off.

***Note:** The Boost button is only available within Nigel and Preflex. The individual Gate/Comp plug-in does not contain the Boost button because Boost only affects the Amp within Preflex.*

**Compressor Threshold Knob** Sets the threshold level for the compression. Any signals that exceed this level are compressed. Signals below the level are unaffected. A Threshold of 0dB yields no compression. The range is 0dB to  $-60\text{dB}$ .

As the Threshold control is increased and more compression occurs, output level is typically reduced. However, the compressor provides an auto-makeup gain function to automatically compensate for reduced levels. Adjust the Output level control if more gain is desired.

**Compressor Ratio Knob** Determines the amount of gain reduction used by the compressor. For example, a value of 2 (expressed as a 2:1 ratio) reduces the signal by half, with an input signal of 20 dB being reduced to 10 dB. A value of 1 yields no compression. Values beyond 10 yield a limiting effect. The range is 1 to 60.



**Compressor  
Attack Menu**

Sets the amount of time that must elapse, once the input signal reaches the Threshold level, before compression will occur. The faster the Attack, the more rapidly compression is applied to signals above the Threshold.

Three Attack values are available: Slow (50ms), Medium (8ms), and Fast (400µs).

**Compressor  
Release Menu**

Sets the amount of time it takes for compression to cease once the input signal drops below the Threshold level. Slower release times can smooth the transition that occurs when the signal dips below the threshold, especially useful for material with frequent peaks. However, if you set too large of a Release time, compression for sections of audio with loud signals may extend to lengthy sections of audio with lower signals.

Three Release values are available: Slow (500ms), Medium (120ms), and Fast (40ms).

**Compressor  
On/Off Button**

Enables or disables the Compressor module within Preflex. The Compressor is engaged when the button indicator is bright red. You can use this switch to compare the compressor settings to that of the original signal or bypass the entire compressor section to reduce UAD DSP load.

## Amp Module

The Preflex Amp is where Nigel's real magic happens. Behind its deceptively simple user interface is "rocket science" in action. The input to the Amp module is received from the Compressor output. The Amp output is passed to the input of the Cabinet module.



Figure 119. The Amp module within Preflex

### Amp Type and Variable Knob Functions

The function of the amp knobs vary depending on the amp type. When an amp type is selected, Preflex is internally reconfigured. Although the amp types are essentially factory programmed presets, they are not simply a set of knob values. As different amp types are selected, the actual function and range of the amp knobs assume new characteristics.

### Color and Bent: Supercontrol

The Color and Bent knobs have especially powerful functionality. Each modifies several amplifier characteristics simultaneously, so they behave as "super controls" that can have a dramatic effect on your sound with just one knob turn.

These are generally the main controls you will reach for when you want to make major changes to the overall dynamic response, timbre, or distortion characteristics of Preflex.

## **Knob Values Are Offsets**

Knob settings do not change to new values when an amp type is selected. This is because knob values are not absolute. Instead, they are an offset to the factory programmed amp type value. For example, if Post-Lo EQ displays a value of 3.0, then 3dB is added to the amp type internal (preset) value. Of course, knob settings do change when user settings are loaded.

## **Amp Types and Morph**

The Amp submodule within Preflex is actually comprised of two independent amplifier processors, Amp-A and Amp-B. The amp types to be used are selected with the Amp Type pull-down menus. The two amp types share the amp controls.

These two amp types can then be 'morphed' to smoothly transform one amp type into another, creating new sounds never before possible. Morph accomplishes this task by interpolating between amplifier component values of the A and B Amp types as the slider is moved. Morph is NOT a blend or crossfade control.

Morph allows you to continuously shift between two completely different amp sounds in realtime with full automation. And because the Color and Bent knobs also control multiple parameters simultaneously (which is essentially a morph), amazing new dynamically shifting timbres can be realized.

## **Amp Controls**

### **Amp EQ Groups**

Preflex has two groups of Lo, Mid, and Hi equalizer controls. Pre-EQ is before the amplifier, and Post-EQ is after the amplifier. Both sets of EQ are available simultaneously.

The actual frequency and bandwidth of a particular EQ knob depends on the amp type setting. The EQ knob values are offsets relative to the preset amp type value; they do not display absolute values.

### **Amp Pre-EQ Knobs**

The Pre-EQ group modifies the tone of the signal before it passes into the Amp. Note that the EQ knob values are offsets relative to the preset amp type value; they do not display absolute values.

#### **Pre-EQ Lo Knob**

Modifies the low frequency response of the signal before the Amp. This control is a set to a fixed frequency, but the frequency changes with the amp type.

### **Pre-EQ Mid Knob**

Modifies the middle frequency response of the signal before the Amp. The frequency that this knob controls is determined by the Color knob (see Color knob description for more details).

### **Pre-EQ Hi Knob**

Modifies the high frequency response of the signal before the Amp. This knob behaves differently than the Lo and Mid knob. Rather than boosting or cutting the gain of a certain frequency, the Hi knob increases the amplifier's sensitivity to high frequencies. The Hi control is VERY interactive with the Bent control.

## **Amp Post-EQ Knobs**

The Post-EQ group modifies the tone of the signal after it passes through the Amp but before it goes to the Cabinet. Note that the EQ knob values are offsets relative to the preset amp type value; they do not display absolute values.

### **Post-EQ LO Knob**

Modifies the low frequency response of the signal after the Amp. This control is a set to a fixed frequency, but the frequency changes with the amp type.

### **Post-EQ Mid Knob**

Modifies the middle frequencies response of the signal after the Amp. The frequency that this knob controls is determined by the Color knob (see Color knob description for more details).

### **Post-EQ Hi Knob**

Modifies the high frequency response of the signal after the Amp. This control is a set to a fixed frequency, but the frequency changes with the amp type.

## **Amp Color Knob**

The Color knob is like a super tone control. It controls several amplifier characteristics simultaneously, and its behavior is determined by the selected amp type.

## **Amp Bent Knob**

The Bent knob is like a super gain control. It controls several amplifier characteristics simultaneously, and its behavior is determined by the selected amp type.

## **Amp Output Knob**

Adjusts the signal output level of Preflex. This may be necessary if the signal is dramatically boosted or reduced by the Gate/Compressor or Amp settings.

**Bright Button**

Increases the brightness of the Amp model. Bright is on when the button glows bright red.

**Amp On/Off Button**

Enables or disables the Amp module within Preflex. The Amp is engaged when the button indicator is bright red. You can use this switch to compare the Amp settings to that of the original signal or bypass the entire Amp section to reduce UAD DSP load.

**Amp Type Menus**

The Amp Type pull down menus establish the overall sound and response of Preflex and also determine the function and ranges of the Amp knobs. Two amp types (A and B) can be active simultaneously by positioning the Morph control between them.

**Note:** For the following descriptions of the Amp models and other references that you may find throughout this manual, please be aware that Fender, Marshall, Mesa, Matchless, Aiken, and any other manufacturer, model name, description, and designations are all trademarks of their respective owners, which are in no way associated or affiliated with Universal Audio. These trademarks and names are used solely for the purpose of describing certain timbres produced using Universal Audio's exclusive modeling technology.

**Amp Type List and Descriptions**

Table 19. Amp Type List and Descriptions

AMP TYPE	DESCRIPTION
Rectified	Modern super-high gain amplifiers
Marsha	Emulations from range of new and old Marshall amps
Bassmon	Fender Bassman and similar amplifiers
Boutique	Matchless, Aiken, and other high-end tube amplifiers
Custom Blues	Designed to achieve those hard-to-nail blues tones. Lower gain.
Supa Clean	Direct input into a channel strip
Super Sat	Extremely high gain amp, breaks up easily in low end
Gemini	Fender Twin and similar clean tube amplifiers
Big Beaver	Distortion pedal stomp-box emulations
Super Custom	Higher-gain and more power than Custom Blues
Big Bottom	Optimized for bass guitar
Super Tweed	Small Fender Champ and Princeton when cranked up loud

### **Amp-A Type Menu**

Determines the amp type for the “A” section of the Amp. Selecting an Amp Type reconfigures the amplifier characteristics and the function of the other Amp parameters.

### **Amp-B Type Menu**

Determines the amp type for the “B” section of the Amp. Selecting an Amp Type reconfigures the amplifier characteristics and the function of the other Amp parameters.

### **Amp Morph Slider**

The Morph control is used to smoothly transform one amp type into another, creating new sounds never before possible. Morph accomplishes this task by interpolating between amplifier component values of the A and B Amp types as the slider is moved. Morph is NOT a blend or crossfade control.

Morph allows you to continuously shift between two completely different amp sounds in realtime with full automation. And because the Color and Bent knobs also control multiple parameters simultaneously (which is essentially a morph), amazing new dynamically shifting timbres can be realized.

## **Cabinet Module**



Figure 120. The Cabinet module within Preflex

The Cabinet module reproduces the sonic character of a guitar speaker and its enclosure as captured by a microphone. The Cabinet receives its input signal from the Preflex Amp output. The Cabinet output is the final Preflex signal output.

The Preflex Cabinets are emulations of actual guitar speaker enclosures that were captured by a Shure SM57 microphone then meticulously analyzed (as usual) by our team of rocket scientists. A wide variety of cabinets are included, using several speaker types, configurations, and microphone placement techniques.

### **Cabinet Type Menu**

Each cabinet type has a unique sound and frequency response characteristic. Select the desired speaker from the Cabinet Type pull-down menu. Abbreviations used in the Cabinet Types list for the speaker, enclosure, and mic techniques are detailed in [Table 20](#). The Cabinet Types list itself is in [Table 21](#).

**Note:** For the following descriptions of the Cabinet models and other references that you may find throughout this manual, please be aware that Celestion, Greenback, Oxford Blue, Marshall, Fender, Line 6, Pod, SansAmp, Shure, ADA, Utah and any other manufacturer, model name, description, and designations are all trademarks of their respective owners, which are in no way associated or affiliated with Universal Audio. These trademarks and names are used solely for the purpose of describing certain timbres produced using Universal Audio’s exclusive modeling technology.

## Cabinet Abbreviations

Table 20. Cabinet Abbreviation Descriptions

ABBREVIATION	DESCRIPTION
1-12, 2-12, 4-12	One, two, or four twelve-inch speaker(s)
1-10, 2-10, 4-10	One, two, or four ten-inch speaker(s)
OB	Open Back cabinet
SC	Sealed Cabinet (closed back cabinet)
On Axis	Mic close and perpendicular (at 90 degrees), off-center
Off Axis	Mic close and angled, off-center
Edge	Mic close and angled at edge of speaker
Far	Mic approximately 2 feet from speaker
1-12 OB	90-watt Celestion (early 1990’s)
2-12 OB	Left speaker: Oxford Blue, Right: Utah (both 60-watt, early 1960’s)
2-12 SC	90-watt Celestions (early 1990’s)
4-12 SC	25-watt Celestion Greenbacks (circa 1967)
British	Emulation of Marshall effects box cabinet
NoCA FXB	Emulation of ADA effects box cabinet
LA FXB	Emulation of Line 6 Pod effects box cabinet
NY FXB	Emulation of SansAmp effects box cabinet

## Cabinet Type List

Table 21. List of Cabinet Types

1-12 OB Off Axis	4-12 SC Edge
2-12 OB Off Axis	2-12 SC Far
1-12 OB On Axis	4-12 SC Far
2-12 OB On Axis	4-12 British
1-12 OB Edge	1-10 NoCA FXB
2-12 OB Edge	2-10 NoCA FXB
1-12 OB Far	4-10 NoCA FXB
2-12 OB Far	1-12 LA FXB
2-12 SC Off Axis	2-12 LA FXB
4-12 SC Off Axis	4-10 LA FXB
2-12 SC On Axis	1-12 NY FXB
4-12 SC On Axis	

**Cabinet On/Off Button**

Enables or disables the Cabinet module within Preflex. The Cabinet is engaged when the button indicator is bright red. You can use this switch to compare the Cabinet settings to that of the original signal or bypass the entire Cabinet section to reduce UAD DSP load.

**Output Level Meter**

This LED-style VU meter displays the level of the signal at the output of the Cabinet. Just before the red 'LED' is illuminated, the signal is at 0dB. In order to avoid overloading your host application signal path, adjust the Preflex output level so that the signal is at or below 0dB.

**Phasor Module**

The Phasor is a frequency-variable comb-filter with low frequency oscillator modulation. It is capable of producing dramatic sweeping and swooshing effects, including modern and classic sounds such as those produced by the Mutron Bi-Phase, Small Stone and MXR series of phasors.



Figure 121. The Phasor plug-in window

**Sync Button**

This button puts the plug-in into Tempo Sync mode. See [Chapter 8, "Tempo Sync"](#) for more information.

**Rate Knob**

Sets the LFO modulation (sweep) rate of the Phasor. The available range is from 0.03Hz to 10Hz.

**Sweep Knobs**

The Sweep knobs determine the frequency range that will be affected by the Phasor. The low and high frequency values can be independently adjusted. This flexible arrangement allows the Phasor to affect a narrow or broad frequency range, and also enables you to tune the frequency response characteristic to match the signal if desired.



### **Sweep Lo Knob**

Sets the lowest frequency of the Phasor. The available range is from 50Hz to 6000Hz.

Because the Sweep Lo frequency cannot be set higher than the Sweep Hi frequency, if the Lo value is increased beyond the Hi value the Hi value will increase to match the Lo value.

### **Sweep Hi Knob**

Sets the highest frequency of the Phasor. The available range is from 50Hz to 6000Hz.

Because the Sweep Hi frequency cannot be set lower than the Sweep Lo frequency, if the Hi value is decreased below the Lo value the Lo value will decrease to match the Hi value.

### **Recirculation (Recir) Knob**

Sets the intensity of the filtering effect. Higher values increase the intensity.

Recirculation allows both positive and negative values. The polarity refers to the phase of the feedback as compared to the original signal. If Recirculation displays a positive value, the feedback will be in phase with the source. If it displays a negative value, then the feedback will be out of phase.

### **Mix Knob**

This control determines the balance between the processed and the original signal. Values greater than 50% emphasize the processed signal, and values less than 50% emphasize the original signal. A value of 100% delivers just the processed (wet) signal, and a value of 0% delivers just the source (dry) signal.

Mix allows both positive and negative values. The polarity refers to the phase of the processed signal as compared to the original signal. If a positive value is displayed, then the processed signal will be in phase with the source. With a negative value, the processed signal is flipped 180 degrees out of phase with the source signal.

**LFO Type Menu**

Determines the LFO (low frequency oscillator) waveshape and phase used to modulate the signal. The waveshape can be set to triangle or sine, each with varying duty cycles and phases.

Table 22. Phasor LFO Types and Descriptions

Sin	Pure sine wave.
Sin 2	Modified sine wave that stays high longer.
Sin 3	Modified sine wave that stays low longer.
Square	Square wave.
Square 2	Modified square wave that stays high longer.
Square 3	Modified square wave that stays low longer.
Sin 180	Sine wave 180 degrees out of phase.
Square 180	Square wave 180 degrees out of phase.

**Order Menu**

Determines the filter order for the Phasor filter banks. This setting affects the tonal complexity of the Phasor. Higher Order filters are more detailed than lower Order filters. Ten filter Order values are available, 3 through 12.

**Phasor On/Off Button**

Enables or disables the Phasor module. You can use this switch to compare the Phasor settings to that of the original signal or bypass the Phasor to reduce UAD DSP load.

## Mod Filter Module

The Mod Filter is an advanced filter plug-in that is capable of fixed-wah, auto-wah, envelope follower, sample/hold-driven filter, and other modulated filter effects. It has been modeled after the Mutron III and other popular filters. The filter cutoff frequency can be controlled by the signal level at the input to the module or a low frequency oscillator (LFO). This realtime dynamic response is what gives the Mod Filter its unique sound.



Figure 122. The Mod Filter plug-in window  
The label and function of the first knob depends upon the Mod Type menu selection.

### Sync Button

This button puts the plug-in into Tempo Sync mode. See [Chapter 8, "Tempo Sync"](#) for more information.

## **Sens/Rate/ Wah Knob**

The function and label of the first knob in the Mod Filter is determined by the Mod Type setting (see [Figure 122 on page 331](#)). When the Mod Type is an envelope, the label changes to “Sens” and determines the gain sensitivity of the Mod Filter. When the Mod Type is an LFO, the label changes to “Rate” and determines the rate of the LFO. When the Mod Type is set to Wah, the label changes to “Wah” and adjusts the wah pedal position.

### **Sens**

When the knob is controlling Sensitivity, a higher setting will have a greater (more sensitive) response to variations in dynamic level.

### **Rate**

When the knob is controlling Rate, a higher setting will increase the rate of filter cutoff frequency modulation by the LFO. The range is from 0Hz to 8Hz.

### **Wah**

When the knob is controlling Wah, a higher setting will have a brighter sound, just like when a real wah pedal is pressed forward.

On a real wah pedal, the wah filter is alternately enabled and disabled by rocking the pedal to the maximum forward position. Similarly, when the Wah knob is moved to the maximum position the wah effect is alternately enabled/disabled until the knob (or an external controller mapped to the knob) is moved to maximum again. This emulates real wah pedal behavior when an external MIDI control pedal is used in realtime. (Hint: add a rubber stopper to the front of your MIDI pedal to fully emulate a real wah pedal.)

## **Sweep Knobs**

The Sweep knobs determine the frequency range of the Mod Filter. The low and high frequency values can be independently adjusted. This flexible arrangement allows the Mod Filter to affect a narrow or broad frequency range, and also enables you to tune the frequency response characteristic to match the signal if desired.

### **Sweep Lo Knob**

Sets the lowest frequency to be affected by the Mod Filter. The available range is from 50Hz to 4000Hz.

Because the Sweep Lo frequency cannot be set higher than the Sweep Hi frequency, if the Lo value is increased beyond the Hi value the Hi value will increase to match the Lo value.

### **Sweep Hi Knob**

Sets the highest frequency to be affected by the Mod Filter. The available range is from 50Hz to 4000Hz.

Because the Sweep Hi frequency cannot be set lower than the Sweep Lo frequency, if the Hi value is decreased below the Lo value the Lo value will decrease to match the Hi value.

### **Resonance (Res) Knob**

Sets the amount of filter intensity for the Mod Filter. A higher value will deliver a sharper, more pronounced effect.

### **Output Knob**

Adjusts the signal output level of the Mod Filter. This may be necessary if the signal is dramatically boosted or reduced by the other settings within the module. The range is from -20dB to 40dB.

### **Mod Type Menu**

Determines the source of the filter modulation. There are three main Mod Types: LFO, Envelope, and Wah Pedal. Each Mod Type is described below.

#### **LFO Mode**

Three LFO modes are available: Sine, Square, and Random. The only difference between the three LFO modes is the waveshape of the Low Frequency Oscillator. Random LFO is chromatically tuned for maximum musicality.

When LFO mode is engaged, the filter cutoff frequency does not respond dynamically to changes in input signal level. Instead, the filter cutoff frequency is varied according to the Rate knob setting.

#### **Envelope Mode**

When Envelope mode is engaged, the filter cutoff frequency responds dynamically in realtime to variations in the input signal level. The amount of dynamic response is determined by the Sensitivity (Sens) knob.

In Env Up mode, a higher signal level sets the filter cutoff to a higher value. In Env Down mode, the envelope is inverted, and a higher signal level sets the filter cutoff to a lower value.

#### **Wah Mode**

When the Wah mode is engaged, the filter cutoff frequency is varied according to the Wah knob setting.

### Wah Pedal Mode

Similar to Wah mode, in Wah Pedal mode the filter cutoff frequency is varied according to the Wah knob setting. However, when the knob reaches its maximum value the effect is bypassed until the knob reaches its maximum value again at which time the effect is re-engaged.

Wah Pedal mode is ideally suited to emulating a real Wah pedal by using a MIDI foot pedal controller.

### Mod Menu Table

Table 23. Mod Filter: Mod Types and Descriptions

Sin	LFO mode with Sine waveshape.
Square	LFO mode with Square waveshape.
Random	LFO mode with Random waveshape.
Env Up	Normal Envelope mode. Filter cutoff frequency is dynamically increased as signal level increases.
Env Down	Inverted Envelope mode. Filter cutoff frequency is dynamically decreased as signal level increases.
Wah	Fixed Wah mode.
Wah Pedal	Fixed Wah mode with latched bypass mode.

### Filter Type Menu

Determines the type of filter to be used by the Mod Filter. This parameter will affect the overall sonic character of the plug-in. Four filter types are available.

Table 24. Mod Filter: Filter Types and Descriptions

Lowpass	Frequencies below the filter cutoff frequency are allowed to pass through the filter.
Bandpass	Frequencies around the filter cutoff frequency are allowed to pass through the filter. Lowest and highest frequencies are not passed.
Highpass	Frequencies above the filter cutoff frequency are allowed to pass through the filter.
Wah	Traditional wah pedal setting.

### Mod Filter On/Off Button

Enables or disables the Mod Filter. You can use this switch to compare the Mod Filter settings to that of the original signal or bypass the Mod Filter to reduce the UAD DSP load.

## TremModEcho plug-in

The TremModEcho is loaded as one plug-in but consists of three modules: Trem/Fade, Mod Delay, and Echo (Figure 123). Each of the module controls is described in the following pages.



Figure 123. The TremModEcho plug-in contains three modules

## Trem/Fade Module



Figure 124. The Trem/Fade module

Trem/Fade is a sophisticated envelope-controlled modulation processor that can produce classic tremolo, fade, and other gain modulation effects. Tremolo is achieved by modulating the amplitude (volume) of a signal with a low frequency oscillator (LFO). Trem/Fade includes some new modes such as Shimmer and VariTrem that enable the production of new volume effects.

### Sync Button

This button puts the plug-in into Tempo Sync mode. See [Chapter 8, “Tempo Sync”](#) for more information.

### Threshold (Thresh) Knob

Sets the threshold level for the Trem/Fade effect. When the signal level exceeds the threshold, the Trem/Fade effect is triggered. The range is 0dB to -80dB.

**Note:** When Trem/Fade is used within the complete Nigel plug-in, the threshold detector is connected to the output of the Gate module. This allows for optimal level tracking independent of the amplifier and other effect settings.

Once a Trem/Fade effect is instigated by crossing the threshold level, the effect will continue until the signal drops below the Threshold level. For example, if a signal is faded in, the signal won't fade in again until its level drops below the Threshold value.

### Trigger LED

The Trigger LED indicates when the Trem/Fade input signal is above the Threshold. It provides visual feedback for optimizing the Threshold setting. The Trigger LED glows bright red when the signal is above the Threshold value.



- Fade In Knob** Determines the signal fade in time. Fade In is typically used to create automatic volume swells. The range is from None to 4000 milliseconds. When set to None, there is no fade in and only the Tremolo effect is active.
- Onset Knob** Determines the time for the Tremolo effect to reach the specified depth. Onset behaves as an intensity ramp for the Tremolo effect. The range is from None to 4000 milliseconds. When set to None, the Tremolo effect begins immediately (when the Threshold value is exceeded).
- Rate knob** Sets the LFO rate for the Tremolo. The range is from 0Hz to 16Hz.
- Depth Knob** Sets the maximum Tremolo depth. The range is from zero to 100%.
- LFO Type Menu** Determines the LFO waveshape used to modulate the signal. The waveshape can be set to sine or square.
- Mode Menu** The Mode menu reconfigures the behavior of the Trem/Fade algorithms and/or the preset parameter settings. Each of the Modes is described below.

#### **Fade Mode**

In Fade mode, when the input signal level crosses the threshold value, the audio will fade in (ramp up) according to the time set with the Fade In knob. The Onset, Rate, and Depth controls are also active in Fade mode.

Two Fade modes are available. Each has a different Fade In curve and therefore a different volume envelope shape.

***Note:** If the Threshold value is set too high for the source signal in Fade mode, the effect will not be triggered and the audio will never fade in.*

#### **Shimmer Mode**

In Shimmer mode, when the input signal level crosses the threshold value, the Tremolo effect will gradually increase according to the time set with the Onset knob. The Fade In knob is also active in Shimmer mode.

Three Shimmer modes are available. Each has a different Onset curve.

***Note:** If the Depth value is zero and/or the Threshold value is set too high in Shimmer mode, you will not hear the Shimmer effect.*

### **Tremolo Mode**

When Tremolo mode is selected, the Fade In and Onset controls are set to zero and the Trem/Fade module behaves as a 'normal' tremolo effect. However, the Fade In and Onset controls are still active and can be adjusted as desired.

Two Tremolo modes are available. Each has different settings but the controls behave exactly the same in both modes.

***Note:** If the Depth value is zero and/or the Threshold value is set too high in Tremolo mode, you will not hear the tremolo effect.*

### **VariTrem Mode**

In VariTrem mode, the tremolo rate is automatically increased or decreased in realtime. The rate is ramped up or down according to the value of the Onset control. For example, if VariTrem Up is selected and Onset has a value of 2 seconds, the Tremolo rate will gradually increase for 2 seconds.

Two VariTrem modes are available. Vari T Up gradually increases the Tremolo rate, and Vari T Dn gradually decreases the Tremolo rate.

***Note:** If the Depth value is zero and/or the Threshold value is set too high in VariTrem mode, you will not hear the VariTrem effect.*

### **Trem/Fade On/Off Button**

Enables or disables Trem/Fade. You can use this switch to compare the Trem/Fade settings to that of the original signal or to disable Trem/Fade amplitude processing.

UAD DSP load is not reduced when Trem/Fade is disabled with the On/Off button. The Trem/Fade amplitude processor remains active even when its audio is disabled so it can be used as a modulation source when using "Trem" as the LFO Type in the Mod Delay module.

## Mod Delay Module



Figure 125. The Mod Delay module  
The label and function of the second two knobs depend upon the Mode menu selection.

The Mod Delay is a short digital delay line that includes a low frequency oscillator. The Mod Delay produces lush chorus, flange, and vibrato effects.

Because the Trem/Fade amplitude processor can be used to control the Mod Delay, sophisticated envelope-controlled flange, chorus, and vibrato modulations can be achieved.

### Sync Button

This button puts the plug-in into Tempo Sync mode. See [Chapter 8, “Tempo Sync”](#) for more information.

### Rate Knob

Sets the LFO modulation rate of the delayed signal. The available range is 0.01Hz to 25Hz.

If the LFO Type menu is set to one of the Trem modes, the Rate is linked to the Trem/Fade module rate. In this scenario the Rate knob value changes to "Trem", adjusting the Mod Delay Rate will have no effect, and the modulation rate is determined by the Trem/Fade module settings (even if the Trem/Fade module is disabled with the On/Off button).

### **Depth & Time/ Sweep Knobs**

The function and label of the second and third controls in the Mod Delay module are determined by the Mode pull-down menu. When the Mod Delay Mode is set to Flanger, the second and third knobs are labeled Sweep Lo and Sweep Hi respectively. When the Mod Delay Mode is set to Chorus or Vibrato, the second and third knobs are labeled Depth and Time respectively.

### **Sweep Knobs**

The Sweep knobs determine the frequency range that will be affected by the Mod Delay. The low and high frequency values can be independently adjusted. This flexible arrangement allows the Mod Delay to affect a narrow or broad frequency range, and also enables you to tune the frequency response characteristic to match the signal if desired.

***Note:** The Sweep knobs are only visible in Flanger mode.*

#### **Sweep Lo Knob**

Sets the lowest frequency to be affected by the Mod Delay. The available range is from 100Hz to 6000Hz.

Because the Sweep Lo frequency cannot be set higher than the Sweep Hi frequency, if the Lo value is increased beyond the Hi value the Hi value will increase to match the Lo value.

#### **Sweep Hi Knob**

Sets the highest frequency to be affected by the Mod Delay. The available range is from 100Hz to 6000Hz.

Because the Sweep Hi frequency cannot be set lower than the Sweep Lo frequency, if the Hi value is decreased below the Lo value the Lo value will decrease to match the Hi value.

### **Depth Knob**

Sets the amount of modulation to be applied to the signal. The maximum available range is 0 to 300 cents. However, the available range is dependent on the Rate setting. Less Depth range is available at slower Rate settings.

***Note:** The Depth knob is only visible in Chorus and Vibrato modes.*

- Time Knob** Sets the modulation delay time. The available range is from 0 to 125 milliseconds. In Vibrato mode, this setting will appear to have no effect if the Recirculation value is zero because the signal is “100% wet” in Vibrato mode.
- Note: The Time knob is only visible in Chorus and Vibrato modes.*
- Recirculation (Recir) Knob** Sets the amount of processed signal fed back into its input. Higher values increase the intensity of the processed signal.
- Recirculation allows both positive and negative values. The polarity refers to the phase of the delays as compared to the original signal. If Recirculation displays a positive value, all the delays will be in phase with the source. If it displays a negative value, then the phase of the delays flips back and forth between in phase and out of phase.
- In the flanger mode, Recirculation has the potential to make some very interesting sounds. Try turning RECIR fully clockwise or counter-clockwise, and set the delay to very short values.
- Damping Knob** This low pass filter reduces the amount of high frequencies in the signal. Turn down this control to reduce the brightness of the sound. Higher values yield a brighter signal. Damping also mimics air absorption, or high frequency rolloff inherent in tape-based delay systems.
- LFO Type Menu** Determines the LFO (low frequency oscillator) source, waveshape, and phase used to modulate the Mod Delay signal.
- When the LFO Type is set to one of the Trem modes, the Rate is linked to the Trem/Fade module rate. In this scenario, the Rate knob value changes to “Trem” and adjusting Rate will have no effect.
- By using the Trem/Fade amplitude processor as the LFO source of the Mod Delay module, extraordinary new timbres can be realized.

## Mod Delay LFO Type Table

Table 25. Mod Delay LFO Types and Descriptions

Sin 0	In-phase sine wave
Sin 90	Sine wave 90 degrees out of phase
Sin 180	Sine wave 180 degrees out of phase
Tri 0	In-phase triangle wave
Tri 90	Sine wave 90 degrees out of phase
Tri 180	Sine wave 180 degrees out of phase
Trem Up	The Trem/Fade module is used as the LFO source. On a stereo signal, both channels ascend in pitch in synchronization with the Trem/Fade amplitude ramp.
Trem Down	The Trem/Fade module is used as the LFO source. On a stereo signal, both channels descend in pitch in synchronization with the Trem/Fade amplitude ramp.
Trem U/D	The Trem/Fade module is used as the LFO source. On a stereo signal, the left channel ascends in pitch as the right channel descends in synchronization with the Trem/Fade amplitude ramp.
Trem D/U	The Trem/Fade module is used as the LFO source. On a stereo signal, the right channel descends in pitch as the left channel ascends in pitch in synchronization with the Trem/Fade amplitude ramp.

## Mode Menu

The Mode menu reconfigures the settings of the Mod Delay controls. Additionally, the function and label of the second and third controls in the Mod Delay module are determined by the Mode menu.

When the Mod Delay Mode is set to Flanger, the second and third knobs are labeled Sweep Lo and Sweep Hi respectively. When the Mod Delay Mode is set to Chorus or Vibrato, the second and third knobs are labeled Depth and Time respectively.

In all modes except Flanger, the function and sound of the controls are identical; only the settings are different. Similarly, in Flanger 1 and 2 modes, the function and sound of the controls are identical; only the settings are different.

Table 26. Mod Delay Mode Menu List

Chorus 1	Flanger 1	Vibrato 2
Chorus 2	Flanger 2	Comb Filter 1
Quad Chorus	Vibrato 1	Comb Filter 2

## Mod Delay On/Off Button

Enables or disables the Mod Delay. You can use this switch to compare the Mod Delay settings to that of the original signal or bypass the Mod Delay to reduce UAD DSP load.

## Echo Module



Figure 126. The Echo module

The Echo module is a delay line used primarily for longer echo effects. When very short delay times or modulation are desired, use the Mod Delay instead. When VERY long delay times are desired, use the UAD DM-L plug-in which has up to 2400 milliseconds available delay per stereo channel.

### Sync Button

This button puts the plug-in into Tempo Sync mode. See “A chart showing expected plug-in counts can be found on our website: <http://www.uaudio.com/support/software/UAD/charts.html>” on page 81 for more information.

### Input Knob

The Input knob attenuates the signal coming into the Echo module. The signal already passed into the Echo module is still processed even when the Input knob is at its minimum value (maximum attenuation).

This functionality enables the Echo to continue to process its signal even when no new signal is being input. Therefore, volume swells with Echo can be automated and high Recirculation effects such as sampling and “infinite repeat” techniques can be realized.

### Time Knob

Sets the delay time between the original signal and the delayed signal. The maximum available delay time is 1200 milliseconds.

### Recirculation (Recir) Knob

Sets the amount of processed signal fed back into its input. Higher values increase the number of delays and intensity of the processed signal.

Recirculation allows both positive and negative values. The polarity refers to the phase of the delays as compared to the original signal. If Recirculation displays a positive value, all the delays will be in phase with the source. If it displays a negative value, then the phase of the delays flips back and forth between in phase and out of phase.

### **Damping Knob**

This low pass filter reduces the amount of high frequencies in the processed signal. Higher values yield a brighter signal. Turn down this control for a darker sound. Damping also mimics air absorption, or high frequency rolloff inherent in tape-based delay systems.

### **Mix Knob**

This control determines the balance between the delayed and original signal. Values greater than 50% emphasize the wet signal, and values less than 50% emphasize the dry signal. A value of 100% delivers just the processed (wet) signal, and a value of 0% delivers just the source (dry) signal. A value of 50% delivers equal signals.

Mix allows both positive and negative values. The polarity refers to the phase of the delays as compared to the original signal. If a positive value is displayed, then all the delays will be in phase with the source. With a negative value, the delayed signal is flipped 180 degrees out of phase with the source.

### **Mode Menu**

The Mode menu determines how the Echoes are processed. The Echo Mode differences can only be heard when the module is applied to a signal on an insert, buss, group, or return that has a stereo output path.

Table 27. Echo Mode Menu List

Echo 1	Ping Pong 2
Echo 2	Clang 1
Echo 3	Clang 2
Ping Pong 1	Slapback

### **Echo On/Off Button**

Enables or disables Echo. You can use this switch to compare Echo settings to that of the original signal or bypass Echo to reduce UAD DSP load.



## CHAPTER 38

# History

### Bill Putnam Sr.

The name M.T. "Bill" Putnam retains a unique status in the audio industry hall of fame- it's legendary even among those who are considered to be legends themselves. Called the "father of modern recording" by no less a luminary than Bruce Swedien, and a "visionary, responsible for motivating new thinking," by respected studio engineer Tom Hidley, Putnam was a true renaissance man in the world of sound and music. As a record producer, engineer, inventor, writer, singer, technician, studio owner and businessman, he excelled at combining his talents in a creative way. A pioneer in recording studio acoustics, Putnam is acknowledged to be the first person to use artificial reverberation for commercial recordings. He also developed the first multi-band equalizers, and with his company Universal Audio, was responsible for the development of classic equipment like the 1176LN and UREI® Time Align monitors. He was involved in the early development of stereophonic recording, and founded studios in Chicago, Hollywood and San Francisco whose legacy still lives on today.

**Early Interests** Born in 1920 in Danville, Illinois, he was influenced by his father, a businessman who also put on radio programs, including a number one country music show. Young Putnam's interests surfaced early; in Boy Scouts he earned a merit badge in wireless, building a crystal set and a one-tube radio. By 15 he was taking the ham radio operator's exam and constructing his own equipment. In high school both his artistic and technical sides emerged full on. He worked repairing radios and renting out P.A. systems, while also singing on weekends with dance bands (for five dollars a night, which included the P.A. rental!), developing his interest in the music business, and realizing, as he has said, that "musicians were my favorite people."

**Universal Recording Corp.** Opens in Chicago Technical college followed, then work at radio stations, and radio engineering work for the Army during World War II. In 1946 Putnam started his own recording studio, Universal Recording Corp., in Evanston Illinois. His goals at the time, besides having a successful business, were the development of new recording techniques and specialized equipment for recording studios.

To that end the manufacturing company Universal Audio, which later became UREI®, was formed. Most of the equipment, including the console, for Universal Recording was built by



Universal Audio. It wasn't long before the company relocated to Chicago, and it was there, in 1947, that Putnam recorded what is generally accepted to be the first "pop" record to use artificial reverberation. The founder of the group The Harmonicats, Jerry Murad, wanted to record using an echo chamber like he'd heard on effects in spooky radio mysteries. Putnam not only financed the record for a piece of the profits, he came up with the idea of using the tiled men's room at Universal Recording to create that echo. The Harmonicats song "Peg-O-My-Heart," became the first million seller smash with more than 1,400,000 copies sold, and the rest was, well, history.

Landmark Recordings Bruce Swedien, a teenager at the time, recalls that the sound on "Peg-O-My-Heart" was a seminal influence on him. "It was the first pop music recording where artificially controlled reverb was used for artistic effect," he explains. "Many of the recordings that were done prior to that had reverb, but it was part of the acoustics of the recording environment. Bill's contribution to the art was that he literally came up with the design of the way the echo or reverb sound is sent from the recording desk and the way it's returned to the mix so that it can be used in a variable amount.

"I was a youngster in Minneapolis in the early 50s when I first heard "Peg-O-My-Heart," Swedien continues, "And I can remember it like it was yesterday. It had an extraordinary effect on me. I didn't understand how the techniques were done, but I knew it had tremendous artistic impact."

Putnam's engineering credits grew quickly; at that time he worked with artists such as Patti Page, Vic Damone and Dinah Washington, and had a million selling record on his own Universal Records label with "Jealous Heart" by Al Morgan. A number of firsts occurred at Universal: the first use of tape repeat, the first vocal booth, the first multiple voice recording, the first 8-track recording trials and experiments with half speed disc mastering.

Universal was becoming famous, doing recordings for the Chicago based labels VeeJay, Mercury and Chess. It was a hub for rhythm and blues recordings including cuts for Muddy Waters, Willie Dixon, Bo Diddley, Little Walter, and Chuck Berry. Jazz artists recorded by Putnam included Stan Kenton, Tommy Dorsey, Count Basie, Dizzy Gillespie, Ella Fitzgerald, Sarah Vaughn, Nat King Cole, and the master, Duke Ellington. Putnam was also producing records for Decca, as well as writing songs and lyrics.



With all this success, Universal Recording went through several incarnations, with the dream version completed in 1955. At that time it was the most advanced and largest independent recording facility in the country attracting top producers like Nelson Riddle, Mitch Miller and Quincy Jones. It was also at that time that Bruce Swedien went to work for the studio.

"It's absolutely true," he states. "Bill Putnam was the father of recording as we know it today. The processes and designs which we take for granted — the design of modern recording desks, the way components are laid out and the way they function, console design, cue sends, echo returns, multitrack switching — they all originated in Bill's imagination."

Murray Allen, who purchased Chicago's Universal Recording from Putnam in 1972 elaborates. "Bill was a brilliant person, highly talented, with a great set of ears," he says. "He was Duke Ellington's favorite engineer, among many, and at one time he had more singles in the top 40 than anybody else. At the time, if you needed something in sound, he was the guy. He designed systems for the Sands and other big showrooms in Las Vegas; John Kennedy flew him out to arrange the sound for the broadcast of his inauguration. He did it all."

Moving West- United Recording Corp. With his Chicago studio so successful, Putnam's clients began urging him to open a facility on the West Coast, and finally he was convinced. In 1957 he sold his interest in Universal Recording, started a new company called United Recording Corp. and moved to Hollywood, taking over a building at 6050 Sunset and starting construction on new studios. Stereo was taking off, and Putnam was determined to incorporate as many technological innovations into the complex as possible.

In 1958, Studio B was completed along with two reverb chambers. The facility soon grew to three studios, a mixdown room, three mastering rooms including one with stereo, and a small manufacturing plant, all in 15,000 square feet. The studios were busy around the clock, with projects from Ricky Nelson to voiceovers for Hanna Barbera cartoons like the Flintstones.

In the early 60s Western Recorders, one block away at 6000 Sunset, was acquired and re-modeled. The studio was renamed United Western, and business continued to grow. The talent behind and in front of the glass in those days reads like a who's who of classic recording: Bones Howe, Wally Heider and Lee Hirschberg were on staff. During the 60s and 70s the studios were jumping 24 hours a day, seven days a week with artists like Frank Sinatra, Bing Crosby, Dean Martin, Sammy Davis, Nat King Cole, Johnny Mercer and Ray Charles. Charles classic "I Can't Stop Loving You" was recorded there, as



well as Sinatra's "It Was A Very Good Year," and The Mamas and The Papas' "California Dreamin'". The United Western studios, still in existence today as both Cello Studios and Allen Sides' Ocean Way Recording, are still considered to be some of the best sounding rooms ever built.

Universal Audio and UREI Meanwhile, upstairs in the 6050 Sunset building Universal Audio was thriving, and changing names. Now called UREI®, the company had acquired the patent rights to the LA-2A leveling amplifier, and also to National Intertel, which became the Teletronix division of UREI®. It was a unique situation; Putnam was always searching for better ways to do things and the combination of studios and manufacturing led readily to new product ideas. Out of this synergy came the 1176LN leveling amplifier, the 1108 FET preamp and, in conjunction with Ed Long, the 813 family of speakers.

Mentor and Innovator Allen Sides, currently owner of Ocean Way Recording, whose studios today encompass almost unchanged what was part of United Western, calls Putnam 'my best friend.' "When Bill started designing control rooms they were about eight feet by six feet and they were calling them booths," he says. "He built the first of what we now call conventional control rooms, with speakers above the windows. The whole control room concept we think of today was Bill's. The first console that had equalizers in every channel was Bill's, the feedback equalizer was Bill's creation, he built all his own limiters, his own consoles, he could tune his own pianos; he basically did the whole deal.

"Around 1962 he was doing half speed cutting, to get the high frequencies on the discs," recalls Sides. "He'd designed his own mastering systems, because you couldn't do it any other way. He was recording on custom made 30ips machines and he was doing all the super hi fi stuff, like the Mercury Living Presence series."

Sides, who is renowned for both his golden ears and his abilities in the 'art of the deal,' appreciated Putnam on many levels. "He was an exceptional businessman, with a tremendous understanding of things," he says. "If I had a complex deal and I couldn't quite figure out how to approach it, I'd sit down with Bill and he'd reason it out in the most amazing way.

"There's a great story about when stereo was coming on. The record companies really weren't that interested — everyone was cost conscious. They didn't want to spend any more money and they were saying that stereo was a waste of time. But Bill could see the potential, and around 1959



he started recording everything with feeds to two control rooms, one for a stereo mix, one for a mono mix. In late '58, '59 and '60 everything Bill did was recorded in both stereo and mono.

"When stereo hit big around '61, none of the record companies had any catalog. But Bill did — he had two and one half years worth. It was a lot of material — understand at that period of time he was doing about \$200,000 a month in the United Western Complex — which is like a million dollars a month now.

"So the record companies came to Bill and said, 'We'll pay you for the tape.' And he said, 'No, you can't pay for the tape, but if you repay me all the studio time that was used in the last two and a half years you have a deal.' And they did. They wrote him a check for the whole thing."

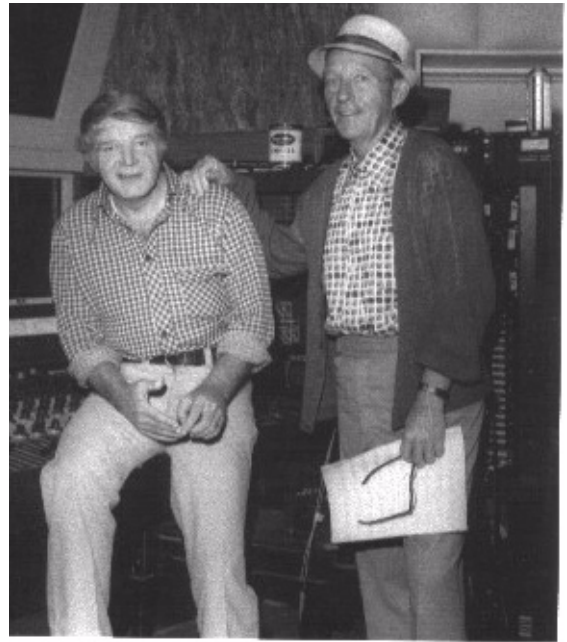

It's recollections like these that bring home Putnam's visionary and entrepreneurial style. An undisputed leader in music recording and in recording technology, with innumerable accolades to his credit, it's his son, Bill Putnam, who perhaps sums it up best, in a way Bill Sr. himself might like. Bill Jr. says, simply, "He was a guy who built equipment to solve problems in the studio."

"There's a whole school of what I'd call Bill Putnam engineers out there," concludes Murray Allen. "People like Allen Sides and Bruce Swedien who worked with him and who really understood what recording sound should be about. They've carried on his tradition, and I think we all agree that it's very important for people to know what he contributed."

## **Classic Compressors**

The LA-2A and 1176 compressor/limiters long ago achieved classic status. They're a given in almost any studio in the world — relied upon daily by engineers whose styles range from rock to rap, classical to country and everything in between. With so many newer products on the market to choose from, it's worth looking at the reasons why these classics remain a necessary part of any professional studio's outboard equipment collection.

The basic concept of a compressor/limiter, is of course, relatively simple. It's a device in which the gain of a circuit is automatically adjusted using a predetermined ratio that acts in response to the input signal level. A compressor/limiter "rides gain" like a recording engineer does by hand with the fader of a console: it keeps the volume up during softer sections and brings it down when the signal gets louder. The dynamic processing that occurs at ratios below 10 or 12 to one is generally referred to as compression; above that it's known as limiting.

Modern day compressors offer a great degree of programmability and flexibility—older devices such as the 1176 and the LA-2A are more straightforward in their design. Perhaps it is this fact that has contributed to their appealing sound and the longevity of their popularity.

## LA-2A

The LA-2A leveling amplifier, a tube unit with hand wired components and three simple controls, was introduced in the mid-1960s. It utilized a system of electro-luminescent optical gain control that was quite revolutionary. Gain reduction was controlled by applying the audio voltage to a luminescent driver amplifier, with a second matched photoconductive cell used to control the metering section. With its 0 to 40 dB of gain limiting, a balanced stereo interconnection, flat frequency response of 0.1 dB from 30-15,000Hz and a low noise level (better than 70 dB below plus 10 dBm output), the LA-2A quickly became a studio standard. Originally patented by Jim Lawrence, it was produced by Teletronix in Pasadena, California, which became a division of Babcock Electronics Corporation in 1965. In 1967 Babcock's broadcast division was acquired by the legendary Bill Putnam's company, Studio Electronics Corporation shortly before he changed the company's name to UREI®. Three different versions of the LA-2A were produced under the auspices of these different companies before production was discontinued around 1969.

## 1176LN

It was Bill Putnam himself who, in 1966, was responsible for the initial design of the 1176. Its circuit was rooted in the 1108 preamplifier which was also designed by Putnam. As is evident from entries and schematics in his design notebook, he experimented with the recently developed Field Effect Transistor (F.E.T.) in various configurations to control the gain reduction in the circuit. He began using F.E.T.s as voltage variable resistors, in which the resistance between the drain and the source terminals is controlled by a voltage applied to the gate. His greatest challenge was to ensure that distortion was minimized by operating the F.E.T.s within a linear region of operation.

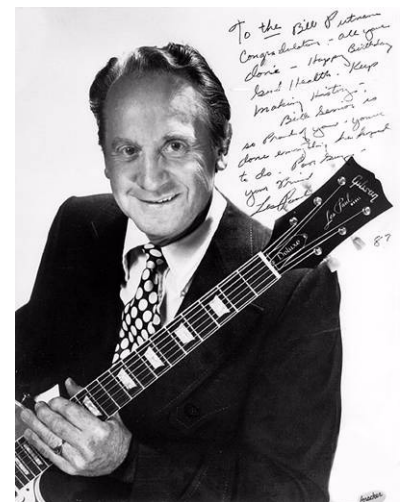

After several unsuccessful attempts at using F.E.T.s in gain reduction circuits, Putnam settled upon the straightforward approach of using the F.E.T. as the bottom leg in a voltage divider circuit, which is placed ahead of a preamp stage.

The output stage of the 1176 is a carefully crafted class A line level amplifier, designed to work with the (then) standard load of 600 ohms. The heart of this stage is the output transformer, whose design and performance is critical. Its primary function is to convert the unbalanced nature of the 1176 circuit to a balanced line output, and to provide the proper impedance matching to drive the line impedance of 600 ohms. These two jobs are accomplished by the primary and secondary windings whose turns' ratio defines the impedance ratio.

This transformer is critical due to the fact that it uses several additional sets of windings to provide feedback, which makes it an integral component in the operation of the output amplifier. Putnam spent a great deal of time perfecting the design of this tricky transformer and carefully qualified the few vendors capable of producing it.

The first major modification to the 1176 circuit was designed by Brad Plunkett in an effort to reduce noise—hence the birth of the 1176LN, whose LN stands for low noise. Numerous design improvements followed, resulting in at least 13 revisions of the 1176. Legend has it that the D and E blackface revisions sound the most “authentic”.

The original Universal Audio 1176LN designed by Bill Putnam was a major breakthrough in limiter technology – the first true peak limiter with all transistor circuitry offering superior performance and a signature sound. Evolved from the popular Universal Audio 175 and 176 vacuum tube limiters, the 1176LN retained the proven qualities of these industry leaders, and set the standard for all limiters to follow.



## Pros Talk UA

Both the 1176 and the LA-2A remain in daily use. Busy engineers and producers' comments about both the 1176 and the LA-2A demonstrate their impact on the industry:

### Mike Shipley:

Mike Shipley (Def Leppard, Shania Twain, Blondie): "I grew up using 1176s – in England they were the compressor of choice. They're especially good for vocals, which is also what I primarily use the LA-2 for. Most anything else I can do without, but I can't be without at least a pair of 1176s and an LA-2A. For example, on the Enrique Iglesias project I'm currently mixing, I'm using both an 1176 and an LA2 on his voice, which is not unusual for me.

"The 1176 absolutely adds a bright character to a sound, and you can set the attack so it's got a nice bite to it. I usually use them on four to one, with quite a lot of gain reduction. I like how variable the attack and release is; there's a sound on the attack and release which I don't think you can get with any other compressor. I listen for how it affects the vocal, and depending on the song I set the attack or release—faster attack if I want a bit more bite. My preference is for the black face model, the 4000 series—I think the top end is especially clean.

"The LA-2A is not as versatile, but it also has a sound that I really like. On certain voices you can crank it heavily, to where you almost want to put a piece of tape over the meter because there's so much gain reduction that you don't want anyone else to see it! I'm not particularly into overcompression, but when you use it that way there's something about it that just sounds really great. It does depend how it's set on the back, where there's a flat control that can be set to roll off certain frequencies when you reduce more gain. If you have a singer with an intensely piercing voice I find that compressor a good one, incredibly useful. It makes things warmer, especially when you crank it, and for thinner voices that can be just the ticket."

### Allen Sides

Allen Sides has always been known for having golden ears when it comes to the sound of equipment. The owner of Ocean Way Studios in Los Angeles and Nashville, he's also a speaker designer and engineer who is especially respected for his work with live musicians, including orchestra





and string dates. Among his recent credits are work with the Goo Goo Dolls, Alanis Morissette and Green Day. Sides brings his different perspectives into play when he talks about using the 1176.

"The 1176 is standard equipment for my sessions. I just used them last night, as a matter of fact, on a project for singer Lisa Bonet that Rob Cavallo was producing at Ocean Way. We were recording drums and I used them on the left/right overheads as effects limiters. It's something I learned from (engineer) Don Landy, who worked with Randy Newman a lot. I mult the left and right overheads and bring them back on the console, then insert a pair of 1176s into a pair of the mults. Push in 20 to one and four to one simultaneously and it puts the unit into overdrive creating a very impressive sound."

### **Murray Allen**

Murray Allen is a veteran engineer and Director of Post Production for the San Francisco Bay Area company Electronic Arts. He has a fascination for gear both old and new and he explains why he thinks the 1176 has been so popular for so long. "It has a unique sound to it that people like, it's very easy to operate, and it does a great job. You have just two controls relative to the ratio of compression. You have input and output and you have attack and release. That's all there is. It's still my favorite limiter for Fender basses and string basses, because you don't know it's working. It doesn't change the way the bass sounds, it just keeps the level at a more controllable place.

### **Ken Kessie**

Mixer Ken Kessie (En Vogue, Tony! Toni! Tone!, Celine Dion) is known for being experimental. "Seems like everybody knows the basic tricks for the 1176," he says, "But here are two that might be lesser known. If you turn the attack knob fully counterclockwise until it clicks, the 1176 ceases to be a compressor and acts only as an amplifier. Sometimes this is the perfect sound for a vocal. And of course the unit can be overdriven, adding another flavor of distortion in case your plug-ins are maxed out!

"Then, for that hard-to-tame lead vocalist (the one that backs up from the mic to whisper and leans in for the big ending chorus), try an 1176 followed by a DBX 165. Use the 1176 as a compressor, and the DBX as a peak limiter...it's guaranteed to be smooth as silk."



## Jim Scott

Jim Scott shared a Grammy for Best Engineered Album for Tom Petty's Wildflowers. He's also known for his work with Red Hot Chili Peppers, Natalie Merchant and Wilco. "I use 1176s real conservatively and they still do amazing things," he comments. "I'm always on the four to one button, and the Dr. Pepper—you know, 10 o'clock, 2 o'clock, and it does everything I need.

"I always use them on vocals. I use them on room mics, on acoustic guitars—sometimes in mixing I'll sneak a little on a snare drum or a separated channel of a snare drum. I'm not one of those guys who leaves it on everything, but I'd have to say I've used an 1176 on everything at one time or another.

"They have an equalizer kind of effect, adding a coloration that's bright and clear. Not only do they give you a little more impact from the compression, they also sort of clear things up; maybe a little bottom end gets squeezed out or maybe they are just sort of excitingly solid state or whatever they are. The big thing for me is the clarity, and the improvement in the top end.

"The 1176 has that same kind of phenomenon, where, when you patch something through a Neve equalizer and you don't even engage the EQ, it sounds better. It's just a combination of the amps.

"I also use LA-2As all the time. I use them on bass, and it's one of the compressors I use for reverb. Often I'll send a bunch of things to one LA2A and bring it back into the console like a return—it's great for drums, great for kick drum especially.

"LA-2As warm things up. They're the opposite of the 1176—they EQ all the warmth and low mids and bass. When you put bass and drums in them they get fatter and bigger. And unless you hit them way hard and make the tubes sizzle they don't really distort. Of course, you can get them to sound like an AC30 if you want to, just turn them all the way up. They are very loud, powerful amplifiers.

"I've also used both the 1176 and the LA-2A for stereo buss compressors—you just have to be a little bit careful that your mixes don't go one sided. Tom's [Petty's] records have often been mixed through 1176s. I've also done that with LA-2As—they are of course, more inconsistent piece to piece than the 1176s, because of the tubes and the difference in fatigue of the tubes.



"My big mentors were Andy Johns and Lee DeCarlo and Ron Nevison because they were all Record Plant guys. I learned how to make a rock and roll record from them. Although over the years it's become my own thing, my style still tends to be that Record Plant style, U87s, 1176s, LA-2As, 47 F.E.T.s...it's what I like."

### **Mike Clink**

Producer/Engineer Mike Clink (Guns N' Roses, Sammy Hagar, Pushmonkey) also comes from the Record Plant school of recording. "I find that I actually use 1176s more now than I ever did," he comments. "I like them because they bring out the brightness and presence of a sound—they give it an energy. It seems like when I'm mixing I end up using an 1176 on the vocals every time. And if I want to compress a room sound I'll take a mono room mic, put an 1176 across it and push in all the buttons."

### **Bruce Swedien**

Bruce Swedien is a master engineer who needs no introduction. He also is a die-hard 1176 fan. "I have two silverface 1176LNs in my rack that Bill Putnam personally picked out for me," he says. "I remember sitting at Bill's place in the Channel Islands, and talking about the 1176 and how I wanted a pair. The next time we went over he'd picked this pair out and they were sitting in his garage waiting for me. I love them on vocals. All of the Michael Jackson and James Ingram vocals that everyone has heard so much were done with at least one of those 1176s. I couldn't part with them for anything. They sound fabulous."



## Thank You

We would like to thank you again for becoming a Universal Audio customer. We urge you to fill out your registration card and send it back to us as soon as possible so we can keep you informed about new UAD Powered Plug-In products that we will be releasing in the months to come.

We always like to hear from our customers and welcome your comments and suggestions. If you have any questions you can email us at:

- [info@uaudio.com](mailto:info@uaudio.com)

In case your audio toolbox needs might include hardware such our UA Classics series please be sure to have a look at our web site for more information about the entire UA family of products:

- <http://www.uaudio.com>

The Universal Audio Team

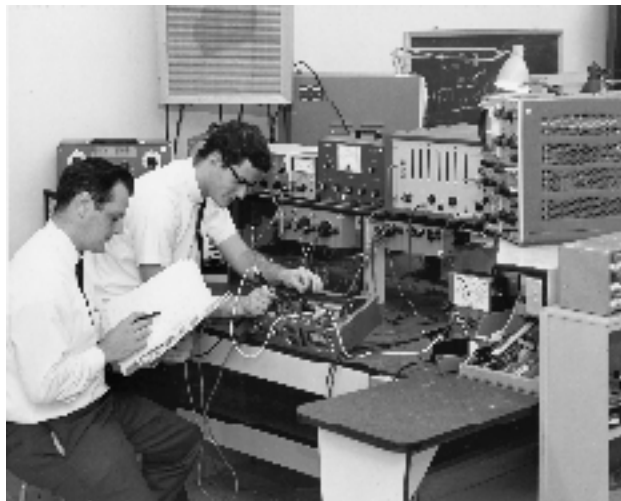

---

# INDEX

## Symbols

.uad Key File 46

## Numerics

1081 Band Layout 225

1176LN 109, 350

1176LN Controls 115

1176SE "Special Edition" 117

1176SE Controls 117

## A

A/B Selector 163, 196, 202, 240, 242, 248

Accessing Meter Functions 56

Account 47

acoustical space 271

Adjusting Parameters 74, 78

AGC Mode 125

Air Blending 273

Air Density Menu 272

algorithm 270

All Button 131

All Buttons mode 116

Always On Top 55

AMD-8131 Mode 67

Amp Bent Knob 324

Amp Color Knob 324

Amp EQ Groups 323

Amp On/Off Button 325

Amp Output Knob 324

Amp Overview 322

Amp Post-EQ Knobs 324

Amp Pre-EQ Knobs 323

Amp Type and Variable Knob Functions 322

Amp Type Descriptions 325

Amp Type Menus 325

Amp Types 323

Amp-A Type Menu 326

Amp-B Type Menu 326

Amplitude & Slope 276

Attack 115

Attack Knob 185

Attenuation Knob 212, 213, 215

Attenuation Selector Switch 213

Audio Interface 39

Authorization 27, 40

Authorization File 43

Authorization Notes 44

Authorization Overview 42

Authorize Plug-Ins 43

Authorize Plug-ins button 61

Authorize Plug-Ins Procedure 27

Authorizing Multiple Cards 51

Auto Mode 144

Automation 81

automation 81

## B

Balance 126

Balance Control 289

Band Controls 163, 196, 240, 242, 248

Band Curves 135

Band Disable Button 184

Band Enable Button 196

Band Parameters 131

Bands 292

Bandwidth (Q) Knob 185

Bandwidth Knob 196, 213

Bass 233

Bent Knob 324

Blending Bar 270

Blending Bars 273

Boost Button 320

Boost Knob 212, 213, 215

Bright Button 325

Buy Button 64, 78

Buying Plug-Ins 48

Bypass 274, 275

---

# INDEX

## C

- Cabinet 326
- Cabinet On/Off Button 328
- Cabinet Type Menu 326
- Cambridge EQ Controls 200
- Cambridge EQ Screenshot 199
- Cambridge Equaliser 199
- Card Enabled 60
- Card Info Display 52
- Card Status 60
- CE-1 237
- CE-1 Chorus Intensity Knob 239
- CE-1 Clip LED 238
- CE-1 Controls 238
- CE-1 Depth Knob 240
- CE-1 Normal/Effect Switch 238
- CE-1 Output Level Knob 239
- CE-1 Power Switch 242
- CE-1 Rate Knob 240
- CE-1 Rate LED 238
- CE-1 Stereo Mode Switch 239
- CE-1 Vibrato Controls 240
- CE-1 Vibrato/Chorus Switch 238
- Channel Input Gain 127
- Circular (jump) 69
- Classic Mode 239
- Color and Bent 322
- Color Knob 324
- Compensating Upsampled Plug-Ins 95
- Compressor Attack Menu 321
- Compressor On/Off Button 321
- Compressor Output Knob 186
- Compressor Ratio Knob 320
- Compressor Release Menu 321
- Compressor Threshold Knob 320
- Configuration Panel 64
- Connections 103
- Control Bats 201
- Control Grouping 194

- Control Panel 57
- Controls Link 127
- Controls View 74
- Copy/Paste Settings 76
- Coupons 42
- CPS Selector Switch 212
- CS-1 Channel Strip 183
- Curve Control Bats 201
- Curve Control Points 135
- Customer Support 18
- Cut Enable Button 203
- Cut Filter 289
- Cut Frequency Knob 203
- Cut Type Menu 203

## D

- Damper Controls (Reverb Time) 285
- Damping Knob 189, 192, 341, 344
- DAW Environment 38
- DC Bias 127
- Decay Time 276
- Default Preset Location 75, 279
- Default Preset Locations 75
- Delay Compensation 88
- Delay Compensator 90
- Delay Knob 191
- Delay/Size Settings Interaction 191
- DelayComp Examples 92, 97
- Demo Activation 45
- Demo Mode 45, 46
- Demo Notes 46
- Depth Knob 188, 337
- Desktop 55
- Detailed System Profile 61
- Diffusion 276
- Dimension D 241
- Dimension D Controls 242
- Dimension D Screenshot 241
- Dimension Mode 242
- Disable Current 56

---

# INDEX

Disabling Cards 52  
Disconnect 106  
Distance 278  
DM-1 Controls 187  
DM-1 Delay Modulator 187  
DM-1L 187  
DM-1L Overview 189  
Documentation Overview 16  
DreamVerb 265  
Dry 279  
DSP 57  
DSP Load 61  
DSP Load Limiting Overview 65  
DSP Loading Information 80  
DSP LoadLock 67  
DSP Settings 71  
Dual Mode 195, 239  
Dynamics 170  
Dynamics Meters 138

## E

Early 277  
Early & Late Adjustment 277  
Echo On/Off Button 344  
Echo Overview 343  
Emagic Logic Audio 73  
Enable Button 204  
Enable/Bypass Switch 185, 186, 189, 192  
energy 267  
Envelope Mode 333  
EQ 285  
EQ Bands 204  
EQ Display 135  
EQ Enable Button 202  
EQ Enable Switch 285  
EQ Response 135  
EQP-1A 210  
EQP-1A Program Equalizer 210  
ER Relative Timing 276  
EX-1 Compressor Controls 185

EX-1 Equalizer and Compressor 184  
EX-1 Equalizer Controls 184  
EX-1M Overview 186  
External MIDI Control 82  
Extra Buffering 67

## F

Factory Presets 279  
Fade In Knob 337  
Fade Mode 337  
Fairchild 670 120  
Fairchild screenshot 121  
Features 15  
Feedback 19  
Filter Type Menu 334  
Filtering 274  
Force Logic to use “live mode” 68  
Frequency 298  
Frequency (fc) Knob 185  
Frequency Controls 137  
Frequency Knob 197, 204

## G

Gain (G) Knob 185  
Gain Knob 197, 205  
Gain Reduction 300  
Gain Reduction Meter 146  
Gate Fast Button 320  
Gate Level Display 319  
Gate Off/On Button 319  
Gate Threshold Knob 320  
Gate/Comp 319  
Grit 116  
Group/Bus 92, 95  
Grouping Tracks Requiring DelayComp 92

## H

Hardware Installation 25  
Headroom 161  
Headroom Switch 162

---

# INDEX

Helios 69 Latency 235  
Helios Type 69 Band Layout 232  
Helios Type 69 Controls 232  
Helios Type 69 Equalizer 231  
Helios Type 69 Screenshot 231  
Help & Support Panel 70  
Help Menu 64, 78  
Hi Knob 329, 333, 340  
Hidden Controls 288  
High Attenuation Controls 213, 215  
High Frequency Controls 213  
High Frequency Knob 286  
High Gain Knob 286  
High Resolution 81  
High-Pass Filter 197  
History 345  
Host Application 38, 280  
Host Application Settings 90  
Host Computer 38  
Host CPU 53  
Host CPU Loads 81  
Host PDC Implementation 88  
Hot Disconnect 106  
Hot Swapping 106  
How to use TrackAdv 94  
Hysteresis 172

## I

I/O Buffers and Latency 40  
Important Notes 108  
In/Out Toggle Switch 212, 214  
Info Display 70  
Input 115, 278  
Input Mode Switch 242  
Install Location 102  
Install Software First 22, 102  
Installation 20  
Installer 36  
Installing the UAD Hardware 26  
Introduction 13

## K

KCS Selector Switch 213  
K-System 144

## L

LA-2A 109, 349  
LA-3A Compressor 118  
LA-3A Controls 119  
LA-3A Screenshot 118  
Late 277  
Late-Field Relative Timing 275  
Late-Field Start 276  
Latency 59  
latency 88  
Latency & Delay Compensation 88  
Latency Calculator 71  
Latest Information 22  
Launching a Powered Plug-In 72  
Launching a UAD Powered Plug-In 72  
Launching the Meter  
    Windows 55  
Launching the UAD Meter & Control Panel 55  
L-Delay Knob 187  
Levels 278  
LFO Mode 333  
LFO Type Menu 330, 337, 341  
LFO Type Pop-up Menu 188  
Limit 293  
Limit CPU Load 66  
Limit DSP Load 66  
Limiter 142  
Linear (slider) 70  
Link Button 190  
Live Processing 99  
LiveTrack Mode 76  
Lo Knob 329, 332, 340  
Load Authorization File 43  
Load/Save Preset 75  
Logic Audio 73



---

# INDEX

Low Cut / High Cut Filters 203  
Low Frequency Controls 212, 215  
Low Frequency Knob 286  
Low Gain Knob 286  
L-Pan Knob 189, 192

## M

Mac OS 17  
Mackie UAD-1 35  
Manual Conventions 17, 19  
Master 202  
Master Level Knob 202  
Materials Blending 273  
Materials Blending Bars 273  
Materials Menus 272  
Materials Panel 271  
Materials panel 267  
Memory 57  
MEQ-5 210  
Meter 116  
Meter Elements 56  
Meter On/Off Button 57  
Meter Pop-up Menu 186  
MIDI Control 82  
MIN 67  
MIN\_GNT 67  
Misc Settings 70  
Mix 279, 293  
Mix Knob 287, 329, 344  
Mixed UAD System 50  
Mod Delay On/Off Button 342  
Mod Delay Overview 339  
Mod Depth 289  
Mod Filter Module 331  
Mod Filter On/Off Button 334  
Mod Rate 289  
Mod Type Menu 333  
Mode Menu 337  
Mode Pop-up Menu 188  
Mode Switch 144

Modes 194  
Modulation 289  
Morph Slider 326  
Multicard DSP Loading 52  
Multicard Setup 104  
Multiple Buttons 242  
Multiple UAD Cards 50  
Mute 279  
My Profile 47  
My Systems 44  
My.uaudio.com 40, 41

## N

Neve 1073 Equalizer 219  
Neve 1073 Latency 164, 223, 296  
Neve 1073 Screenshot 156, 219  
Neve 1073SE 164, 222  
Neve 1073SE Controls 164, 223  
Neve 1081 Controls 119, 170, 225, 232, 298, 302  
Neve 1081 Equalizer 224  
Neve 1081 Latency 230  
Neve 1081 Screenshot 118, 169, 224, 231  
Neve 1081SE 230  
Neve 1081SE Controls 230  
Neve 33609 Compressor 155  
Neve 33609 Controls 157  
Neve 33609 Screenshot 156  
Neve 33609SE 164  
Neve 88RS Band Layout 178  
Neve 88RS Channel Strip 168  
Neve 88RS Controls 170, 291  
Neve 88RS Screenshot 169  
Nigel 210, 316, 317  
Nigel Modules 213, 215, 317  
Note Values 84  
Nuendo 72

## O

Offline Authorization 29  
On/Off Button 342, 344

---

# INDEX

- On/Off Rotary Switch 212
  - Online Documentation 18
  - Onset Knob 337
  - Optional Plug-Ins 36, 41
  - Order Menu 330
  - Output 115, 278
  - Output Knob 185, 189, 192, 333
  - Output Level Meter 328
  - Output VU Meter 286
  - Overview 118, 128, 149, 155, 165, 168, 183, 219, 224, 231, 243, 290, 297, 301, 305
- P**
- Package Contents 16, 102
    - parameter 78
  - Parameter Copy Buttons 195
  - Parametric EQ 205
  - Parametric Type Selector 205
  - Peak 119
  - Peak Level 220, 225, 244
  - Peak Reduction 113
  - Phasor Module 328
  - Phasor On/Off Button 330
  - Plate 140 283
    - Plate 140 Controls 284
    - Plate 140 Overview 283
    - Plate 140 Screenshot 283
    - Plate Select Switch 284
  - Platforms 17
  - Plug-In Formats 39
  - Plug-In License Policy 50
  - Plug-Ins Panel 61
  - Plugs parameter 94
  - Positioning panel 267, 276
  - Post-EQ Hi Knob 324
  - Post-EQ LO Knob 324
  - Post-EQ Mid Knob 324
  - Power 240
  - Power Down! 103
  - Power Lamp 287
  - Power Requirement 51
  - Power Switch 196, 287
  - Powered Plug-Ins 36
  - Precision Buss Compressor 149, 165
    - Precision Buss Compressor Controls 150, 166
    - Precision Buss Compressor Screenshot 150
  - Precision De-Esser 149, 297
    - Precision De-Esser Controls 298
    - Precision De-Esser Screenshot 297
  - Precision Enhancer kHz 301
    - Precision Enhancer kHz Controls 302
    - Precision Enhancer kHz Screenshot 302
  - Precision Equalizer 193
    - Precision Equalizer Controls 194
  - Precision Limiter 142
    - Precision Limiter Controls 143
    - Precision Limiter Latency 141, 148, 198
    - Precision Limiter Meters 144
    - Precision Limiter Screenshot 143
  - Precision LimiterGroup/Bus Example 97, 98
  - Precision Maximizer 290
    - Precision Maximizer Controls 291
    - Precision Maximizer Operating Tips 295
    - Precision Maximizer Screenshot 291
  - Precision Multiband 128
    - Precision Multiband Latency 141
    - Precision Multiband Screenshot 128
  - Pre-Delay 280
  - Predelay Knob 286
  - Pre-EQ Hi Knob 324
  - Pre-EQ Lo Knob 323
  - Pre-EQ Mid Knob 324
  - Preflex Features 318
  - Preflex Module 318
  - Preflex Overview 318
  - Pre-Flight Check 105
  - Preset Design Tips 281
  - Preset Management 279
  - Preset/Settings Compatibility 75

---

# INDEX

Program 57  
Pultec EQP-1A Program Equalizer 210  
Pultec Latency 211  
Pultec MEQ-5 210  
Pultec-Pro 210  
Purchase Procedure 48  
Purchasing Plug-Ins 48

## Q

Q (Bandwidth) Knob 205  
QuickStart DVD 18  
QuickStart Video 43

## R

Rate 332  
Rate Knob 188, 328, 332, 339  
Rate knob 337  
Ratio 115  
Ratio Knob 186  
R-Delay Knob 187  
ReadMe 16  
RealVerb Pro 250  
RealVerb Pro Background 251  
Recirculation (RECIR) Knob 188, 191  
Recirculation (Recir) Knob 329, 341, 343  
Reconnect 107  
Recovery 157, 158  
Reflections End 274  
Reflections Panel 273  
Reflections panel 267  
Reflections Start 274  
Registration 47  
Relative Circular (grab) 69  
Release 115  
Release all DSP resources on Audio Unit bypass 68  
Release all DSP resources on AudioUnit bypass 68  
Release Knob 185  
Resonance (Res) Knob 333  
Resonance panel 267  
Resource Gauges 56

resources 72  
Response Curve Color 200  
Response Curve Display 200  
Retail Packages 41  
Reverb 284  
Reverb Time Meters 285  
Reverberation panel 267, 275  
Roland 241, 242  
Roland CE-1 237, 241  
Roland CE-1 Controls 238, 242  
Roland CE-1 Overview 237, 241  
Roland CE-1 Screenshot 237  
Roland Dimension D 241  
Roland Dimension D Controls 242  
Roland Dimension D Screenshot 241  
Roland RE-201 243  
Roland RE-201 Controls 244  
Roland RE-201 Interface 244  
Roland RE-201 Screenshot 244  
Room Shape and Material 250  
R-Pan Knob 189, 192  
RS-1 Controls 191  
RS-1 Reflection Engine 190  
Run On Menu 64

## S

Samples parameter 91, 94  
Save/Load 279  
Screen Shots 17  
Scroll Wheel 79  
Sends 92  
Sens 332  
Sens/Rate/Wah Knob 332  
Settings Menu 75  
Shape 292  
Shape Blending Bar 270  
Shape Menus 270  
Shape Panel 269  
Shape panel 267  
Shape Pop-up Menu 191

---

# INDEX

Shelf Enable Button 208  
Shelf EQ 208  
Shelf Type Button 208  
Shimmer Mode 337  
Shortcuts 79  
Sidechain Link 126  
Signal Flow 266  
Size 280  
Size Knob 191  
Slope 276  
Software Installation 23  
Software Instructions 105  
Software Removal 32  
Software Updates 22  
Solo 298  
Solo Display 139  
Sonar Compatibility Mode 68  
Space 281  
Spatial Characteristics 280  
Spectral Characteristics 252  
spectral characteristics 275  
Speed 298  
SPL Transient Designer 305  
SPL Transient Designer Applications 308  
SPL Transient Designer Controls 306  
SPL Transient Designer Screenshot 305  
SPL Transient Designer Technology 312  
Split 299  
Startup Sequence 104  
Stereo 119  
Stereo Mode 194  
Stereo Operation 113, 116  
Support Website 18  
Supported Hosts 21  
Sweep Hi Knob 329, 333, 340  
Sweep Knobs 328, 332, 340  
Sweep Lo Knob 329, 332, 340  
Sync Button 187, 191  
System 44

System Information Panel 58  
System Overview 33  
System Requirements 21, 22, 101

## T

Tempo Sync 83  
Tempo Sync Modes 86  
Tempo Sync Plugins 83  
Text Entry 79  
Thank You 356  
The UAD System 16  
Threshold 125, 150, 298  
Threshold (Thresh) Knob 336  
Threshold Knob 186  
Time Constant 126  
Time Knob 343  
Toggle initial value modifier 70  
Toolbar 74  
Track Advance 93  
TrackAdv Examples 94  
Transfer Video 49  
Transferring UAD cards and licenses 49  
Transient Designer 305  
Trem/Fade 336  
Trem/Fade On/Off Button 338  
TremModEcho Module 335  
Tremolo Mode 338  
Trigger LED 336  
Type I 206  
Type II 206  
Type III 207  
Type Menu 333, 334, 337, 341

## U

UA Online Store 46  
UAD Control Panel 57  
UAD Drivers 37  
UAD Environment 33  
UAD Hardware 26, 33, 104  
UAD Meter & Control Panel 37, 54

---

# INDEX

UAD Nomenclature 17  
UAD Plug-In Window 73  
UAD Software 36  
UAD Software Installation 23  
UAD Toolbar 74  
UAD-1 Family 35  
UAD-1 Hardware 26, 104  
UAD-1 Host Compatibility 68  
UAD-1 PCI 67  
UAD-2 DSP 66  
UAD-2 Family 34  
UAD-2 LED 31  
UAD-Xpander 35, 100  
UAD-Xtenda 35  
UAD-Xtenda 104  
UAD-Xtenda Installation 104  
Unlicensed Plug-Ins 31  
Upsampled Plug-Ins 95  
Upsampling Values Table 96  
Use Host Mode 70  
User Documentation 37  
User Interface Settings 69  
User Manual 17  
Users Forum 18  
Using Powered Plug-Ins 54, 72, 88, 104  
Using the Meter 55  
Using the UAD Meter 55  
Using UAD Powered Plug-Ins 72  
Using UAD-Xpander 105

## V

VariTrem Mode 338  
VCA VU 165  
VCA VU Controls 166  
VCA VU Screenshot 165  
Verifying Installation 31  
Video Documentation - QuickStart DVD 18  
Vouchers 42  
VSTi 91  
VU Meter 244

## W

Wah 332  
Wah Pedal Mode 333, 334  
Webzine 18  
Welcome 13  
Wet 279  
Wet Solo Button 287  
Wet/Dry Mix Knob 189, 192  
When to use TrackAdv 93  
Width 299  
Width Knob 286  
Windows 17

## X

Xpander 25, 100  
Xpander Connections 103  
Xpander Installation 102  
Xpander Notes 108  
Xpander Operation 104  
Xpander System Requirements 101  
Xpander System Sleep 107  
Xpander Videos 101  
Xtenda 104

## Z

Zoom Buttons 201

---

# INDEX

