



# Relay G55 Digital Wireless

## **Pilot's Handbook**

**Manuel de pilotage**

**Pilotenhandbuch**

**Pilotenhandboek**

**Manual del Piloto**

**取扱説明書**

## Important Safety Instructions

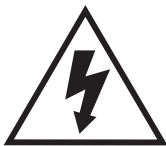

**CAUTION**  
**RISK OF ELECTRIC SHOCK DO NOT OPEN**



**WARNING** : TO REDUCE THE RISK OF FIRE OR ELECTRIC SHOCK, DO NOT REMOVE SCREWS. NO USER-SERVICEABLE PARTS INSIDE. REFER SERVICING TO QUALIFIED SERVICE PERSONNEL.

**WARNING** : TO REDUCE THE RISK OF FIRE OR ELECTRIC SHOCK, DO NOT EXPOSE THE APPLIANCE TO RAIN OR MOISTURE.

### CERTIFICATION

THIS DEVICE COMPLIES WITH PART 15 OF THE FCC RULES. OPERATION IS SUBJECT TO THE FOLLOWING TWO CONDITIONS: (1) THIS DEVICE MAY NOT CAUSE HARMFUL INTERFERENCE, AND (2) THIS DEVICE MUST ACCEPT ANY INTERFERENCE RECEIVED, INCLUDING INTERFERENCE THAT MAY CAUSE UNDESIRE OPERATION.

**Warning:** Changes or modifications not expressly approved in writing by Line 6 may void the users authority to operate this equipment.

**RF Exposure Statement:** This transmitter must not be co-located or operated in conjunction with any other antenna or transmitter.

**Note:** This equipment has been tested and found to comply with the limits for a Class B digital device, pursuant to part 15 of the FCC Rules. These limits are designed to provide reasonable protection against harmful interference in a residential installation. This equipment generates, uses and can radiate radio frequency energy and, if not installed and used in accordance with the instructions, may cause harmful interference to radio communications. However, there is no guarantee that interference will not occur in a particular installation. If this equipment does cause harmful interference to radio or television reception, which can be determined by turning the equipment off and on, the user is encouraged to try to correct the interference by one or more of the following measures:

- Reorient or relocate the receiving antenna.
- Increase the separation between the equipment and receiver.
- Connect the equipment into an outlet on a circuit different from that to which the receiver is connected.
- Consult the dealer or an experienced radio/TV technician for help.

This Class B digital apparatus complies with Canadian ICES-003. This Category II radio communication device complies with Industry Canada Standard RSS-310. Cet appareil numerique de la classe B est conforme a la norme NMB-003 du Canada. Ce dispositif de radiocommunication de catégorie II respecte la norme CNR-310 d'Industrie Canada



**You should read these Important Safety Instructions.  
Keep these instructions in a safe place**



Before using your Relay G55 Digital Wireless System, carefully read the applicable items of these operating instructions and the safety suggestions.

1. Obey all warnings in the Relay G55 manual.
2. Do not perform service operations beyond those described in the Relay G55 Manual. Service is required when the apparatus has been damaged in any way, such as:
  - liquid has been spilled or objects have fallen into the apparatus
  - the unit has been exposed to rain or moisture
  - the unit does not operate normally or changes in performance in a significant way
  - the unit is dropped or the enclosure is damaged
3. Do not place near heat sources, such as radiators, heat registers, or appliances which produce heat.
4. Guard against objects or liquids entering the device. Do not use or place unit near water.
5. Do not step on cords. Do not place items on top of cords so that they are pinched or leaned on. Pay particular attention to the cord at the plug end and the point where it connects to the device.
6. Clean only with a damp cloth.
7. Only use attachments/accessories specified by the manufacturer.
8. Prolonged listening at high volume levels may cause irreparable hearing loss and/or damage. Always be sure to practice "safe listening."

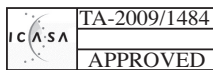

20545/SDPPI/2011  
3794

20543/SDPPI/2011  
3794



Thank you for your purchase of the Relay G55 wireless guitar system. It is a sophisticated digital wireless system, yet is easy to configure and use within minutes. With its fully digital transmission, the system provides features and benefits that differ in some ways from previous generations of analog wireless, but in most respects you use it just like other wireless systems. By understanding a few simple concepts, you'll be able to achieve superior audio quality, a secure and dropout-free signal, and the ability to use multiple channels of wireless together without interference or other conflicts.

- Digital transmission in the 2.4 GHz band – license-free operation worldwide avoids interference from high-power TV transmitters in the UHF band
- 24 bit digital technology provides the audio response of a cable, without companding
- Up to 117 dBA dynamic range, and 10 Hz – 20 kHz bandwidth
- 4th-generation technology promotes reliable, dropout-free performance
- Fast setup: without the need for gain, squelch or pilot adjustment
- 12 channels supporting up to 12 simultaneous systems
- 300 foot (100 meter) range
- Accurate battery-life indicators on both transmitter and receiver
- Real-time LED ladders display critical performance parameters, including RF level, audio level, and transmitter battery level
- Setup menus on transmitters provide additional parameter adjustments

## RECOMMENDATIONS FOR BEST PERFORMANCE

- Maintain a clear line of sight between the transmitter and receiver antennas. Typically the receiver antennas should be above head level. Avoid placing the receiver in the bottom of a rack or cabinet unless remote antennas are employed.
- Avoid placing the receiver behind walls. When this is necessary the receiver's antennas should be remotely located as to be in sight of the transmitter.
- Avoid placing the receiver in close proximity to RF generating equipment including computers, wireless access points and microwave ovens.
- Point the antennas up and 45 degrees from vertical while avoiding touching metal objects like rack or rack rails.
- Avoid blocking antennas in the transmitters. Avoid placing the Bodypack transmitter in pockets.

## SUPPLIED COMPONENTS

**Relay G55 Receiver:** receiver, 9V/0.5A external universal power supply, two (2) half-wave articulating antennas, user's manual

**TBP12 Bodypack Transmitter:** two (2) AA alkaline batteries; optional lavalier mic with windscreen and clip or headset mic with windscreen. Optional carry case

**Available Accessories include:** XD-AD8 antenna distribution system and remote antennas.

Relay G55 / XD-V55 Rack Mount Kit

# RELAY G55 DIGITAL WIRELESS QUICK SETUP

## Receiver

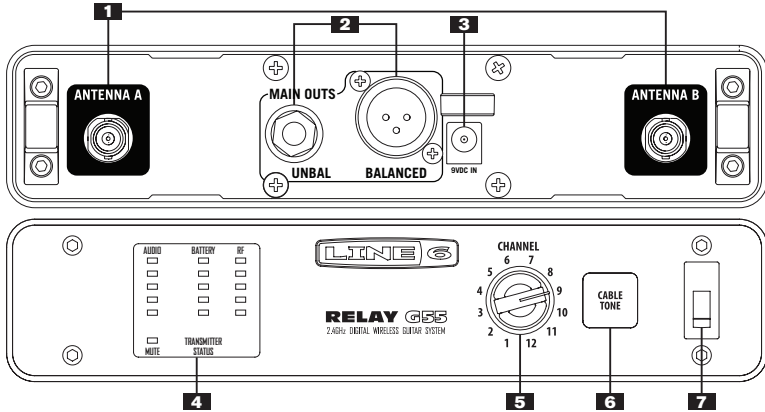

### 1. Antenna A & B Input Connectors (BNC)

### 2. Unbalanced 1/4-Inch and Balanced XLR Audio Output Connectors

### 3. 9VDC Power Input Connector

### 4. Transmitter Status LED Displays

**AUDIO** – lights green to indicate audio signal level, top clip LED lights red to indicate the audio is clipping

**MUTE** – lights red when transmitter is muted

**BATTERY** – lights green, with all lit indicating full transmitter battery; bottom LED turns red when 1 hour remains, and flashes red when less than 40 minutes remains

**RF** – lights green to indicate transmitter signal strength/quality; with transmitter off, red lights indicate interference on that channel

### 5. Channel Select Encoder – selects channels 1 through 12

### 6. Cable Tone Button – engages a 25 foot cable model to provide the same tone you get when plugged in

### 7. Receiver Power Switch

Plug the power supply cable into the receiver and AC power. Connect and position the antennas. Connect with an audio cable to a mixer or similar. Turn on the receiver power switch. Turn the **Channel Select Encoder** to select a channel. Press the **Cable Tone Button** if desired. The receiver is ready to use

# Bodypack Transmitter

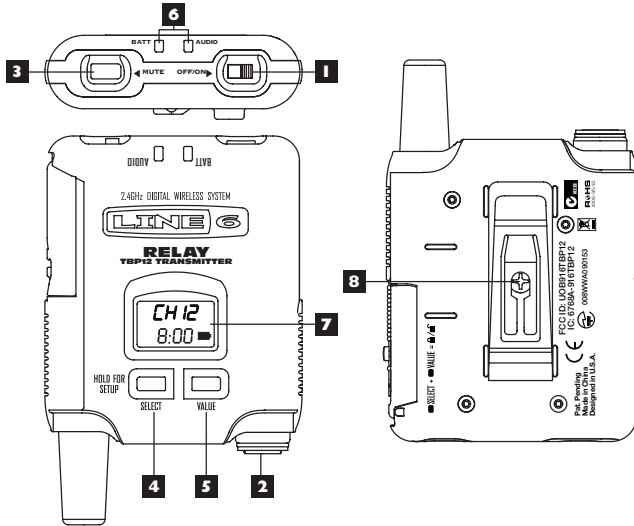

1. **ON / OFF Switch**
2. **Mini-XLR (TA4) Input Connector**
3. **MUTE Switch**
4. **SELECT**
5. **VALUE**
6. **Battery & Audio Status LEDs** – Battery LED is blue when good, red when low, flashing when very low; Audio LED is green for audio signal and red for clipping.
7. **LCD Display Panel** – Backlight will light briefly when transmitter is turned on and when changing pages; will stay lit when muted; display also functions as programming window.
8. **Belt Clip** – Can remove the center mounting screw to reposition or remove, as necessary.

Open the battery door on the side of the bodypack and insert two AA batteries. Slide the **ON/OFF** switch to turn on. Press and hold the **SELECT** button for two seconds, and CH and a flashing channel number will appear on the LCD screen. Press the **VALUE** button repeatedly in order to change the channel number to match the receiver. Press and hold the **SELECT** button for two seconds to select and return to the main screen. The transmitter is ready to use.

## RELAY G55 RECEIVER DETAILED SETUP

For stand-alone placement, position the receiver on a level surface where the front-panel controls and displays are visible.

- Connect the supplied DC-1g power supply to the 9 VDC In connector on the rear panel.
- To secure, press a loop of the cable through the cable holder located above the connector to prevent accidental disconnection.
- Plug the power supply into an available AC outlet that provides voltage from 90 – 240 VAC.
- Place the supplied half-wave antennas on the left and right BNC connectors marked **Antenna A** and **Antenna B**. Rotate a quarter-turn clockwise, and then position the antennas at an approximately 45 degree “rabbit ears” orientation.
- On the right side of the front panel, turn on the power switch; the LED will light.
- Turn the encoder to select the desired channel, from 1 to 12.
- To sync the Bodypack transmitter to the receiver, follow the procedure in the following transmitter setup sections.

**Note:** The receiver’s RF channel will change immediately to a new frequency when the encoder is turned.

**Note:** The **Audio** level meter has 4 lower green LEDs that correspond with specific audio input levels, plus a red clip light in the top position. From bottom to top, LED 1 = -60 dB, 2 = -30 dB, 3 = -18 dB, and 4 = -6 dB.]

## TBPI 2 BODYPACK TRANSMITTER DETAILED SETUP

To begin, press the small oval battery lock button on the left side of the transmitter (same side as the antenna and **OFF/ON** slide switch), and slide the rubberized rectangular latch up toward the switch. The battery door will flip open. Insert two AA batteries, noting the polarity markings on the metal insert on the inside of the door. Close the battery door and slide the battery latch to the original position. Slide the **OFF/ON** switch to the On position; the display will show the currently selected channel and remaining battery life.

**Note,** Use alkaline batteries, or rechargeable NiMH batteries in the 2400 – 2800 mAh range. See *Battery Level Indicator Functions*, for more details.

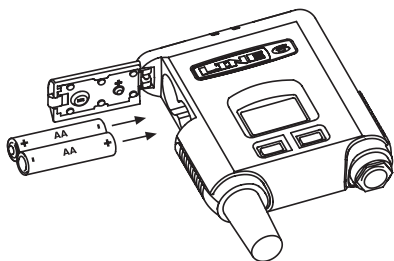

The Bodypack transmitter has a TA4M 4-conductor connector designed to work with the included TA4 to 1/4” guitar cable. Align this connector until it slides easily into the bodypack, and press down until it is seated. To remove, press the button on the side of the TA4F connector and pull straight out. Plug the 1/4 inch end of the cable into your guitar and you are ready to go.

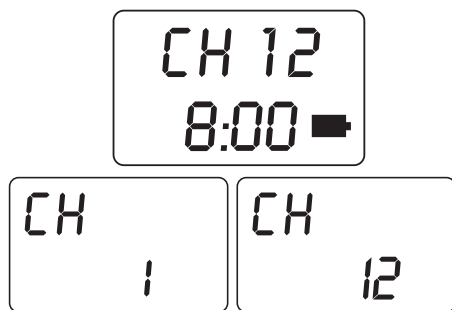

The transmitter must be set to the same channel as the receiver it is to work with (if the receiver is on channel 9, the transmitter must also be set to channel 9). Press and hold the **SELECT** button for two seconds, and the display will show [CH] on the top line, and the currently selected channel on the second line. Press the **VALUE** button to go through channels 1 through 12, with each click incrementing to the next channel; the channel number will flash. At the desired channel, stop and press and hold the **SELECT** button for two seconds (or do not press any button for 15 seconds). The transmitter will then change to the newly selected frequency, and return to the main display. Check the receiver display to confirm that the transmitter signal is being received.

**Note:** The transmitter must be set to the same channel as the receiver it is to work with (if the receiver is on channel 9, the transmitter must also be set to channel 9). Check the receiver's **RF** and **Audio LED** displays to confirm that the transmitter signal is being received.

When the transmitter is on, a quick push and hold of the **MUTE** button will mute the audio, and the backlight will remain lit while it is muted. The word [MUTE] will appear on the display. Another quick push will un-mute it.

## CONNECTING THE RELAY G55 RECEIVER

The receiver features a balanced XLR and unbalanced (tip-sleeve) quarter-inch connector. To connect to a mixing board or powered mixer, use a microphone cable between the receiver output and the mixer's mic-level input – in the same way as you would connect a wired microphone.

To connect to an instrument amplifier or other audio equipment with a quarter-inch connector such as a signal processor or effects unit, use a quarter-inch to quarter-inch instrument cable; this output is also mic level. **Note:** Do not use TRS or Stereo style connectors/cables with the ¼ inch connector as the ring is used for data transmission in factory setup and may cause computer like noise to be coupled into your audio.

### Cable Tone

The **Cable Tone Button** provides the user with the option to simulate the same roll off of high frequencies as a typical 25 foot guitar cable would provide. So if your tone is a little bright compared to what you are used to when using a cable, try the cable tone setting. The cable tone is on when the button back light is on.



# SETTING OTHER TRANSMITTER FUNCTIONS

## Locking, Unlocking, and Muting the Transmitter

TBP12 transmitters can be locked to prevent accidental button pushes from handling during use. When locked, the user cannot mute or turn off the transmitter, or change the frequency or other settings, assuring that an error with a transmitter will not interrupt the event. After use, it is easy to unlock the transmitter to turn off or change settings. When not locked, the transmitter can be muted so that it keeps transmitting but audio is temporarily disabled.

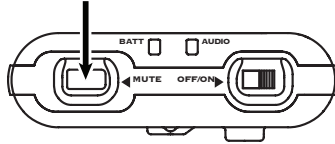

To mute the TBP12 bodypack, push and briefly hold the **MUTE** button on the top of the pack; press again to unmute.

To lock the TBP12 bodypack, turn it on and check the settings, and check the receiver display for signal. With two fingers, press the **SELECT** and **VALUE** buttons at the same time and hold for two seconds. The word [LOCKED] will appear on the top line of the display for a moment, and then revert to the main screen. Test by pressing any of the buttons to assure that it is locked. Locking will also temporarily disable the **OFF/ON** switch. To unlock, again hold the **SELECT** and **VALUE** buttons for two seconds.

Press together and hold

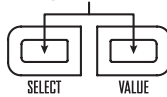

## Battery Level Indicator Functions

Line 6 transmitters contain battery level indicators that can accurately assess the remaining battery life, and show this information on both the transmitter and the associated receiver. These indicators are calibrated to commercial alkaline batteries, and can also provide useful information when used with rechargeable batteries.



When the transmitter is turned on, the bottom line of the display will show the remaining battery life in hours and minutes, with a battery icon next to the time. The remaining battery life is shown in increments of twenty minutes (Hours:20). The initial time indicated just after the transmitter is turned on, and for the first few minutes, will often show more time than is actually remaining – this is due to the characteristic of alkaline batteries to temporarily increase in voltage for a short time after a period of rest. For best accuracy, wait about twenty minutes after transmitter turn-on to rely on the time indicator.

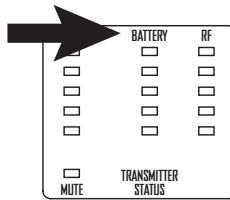

On the receiver, the remaining battery life will be shown on the middle 5-position LED ladder, which indicates remaining battery life in one-hour steps. When remaining battery life is more than five hours, all five LEDs are lit, with between four and five hours left, four LEDs are lit, and so on. When less than one hour of battery life remains, the bottom LED will turn from green to red – and will begin to flash in the last 40 minutes of life.

NiMH (nickel metal hydride) batteries in the 2400 – 2800 mAh range are recommended as rechargeable batteries to use with the TBP12 transmitters. Make sure that the batteries fit properly in the battery compartments to prevent damage, since these batteries can vary in diameter and length. They need to be charged in the correct external battery charger; the transmitters are not designed for batteries to be charged internally. Because the transmitter’s battery meter was calibrated for alkaline batteries, they will not be as accurate in calculating the remaining battery life when using rechargeable batteries

**Note,** Carbon-zinc batteries are not recommended.

## RANGE AND INTERFERENCE TESTING

The Relay G55 receiver’s RF LED ladder provides a useful tool for selecting the clearest channels, avoiding interference, and preventing the wireless microphone systems from interfering with other wireless devices. Using this function before operating the systems in new locations will promote trouble-free and compatible performance.

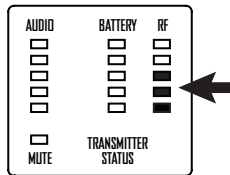

## Detecting Interference with the RF Meter

The Relay G55 receiver has an LED ladder (stacked LED meter) labeled RF, which detects signals on the channel frequencies to which it is currently set (for example, when set to Line 6 channel 7, it detects frequencies with either a 2.433 GHz or 2.467 GHz center frequency). These LED’s are green when receiving signal from a Line 6 transmitter, and red when the transmitter is off and interfering signals on that frequency are present. If the receiver is on and the associated transmitter is off, and one or more of the LEDs on the RF meter are lit red, it is detecting a potentially interfering signal. The more LEDs that are lit, the stronger the signal – and the more it will interfere with the range and performance of a transmitter on that channel.

**Note:** When the associated bodypack is on, these same bars show the transmitter’s signal strength at the receiver’s antennas. During normal operation, you should see four green bars – and as you begin to exceed the range you will see fewer bars. At three bars the signal will still be good, and at two it should still be acceptable and provide reliable audio.

## Walk-Testing the Performance Area

When first setting up a wireless system in a new location, it is good practice to position the receiver and its antennas where they will remain during the event, and then walk the entire performing area with the audio system on and the transmitter active. Talk and listen for signal dropouts or other problems, and note where they are with respect to your antenna placement.

If you for some reason cannot turn on the audio system, with one person to walk with the transmitter and another to monitor the receiver, you can use the RF LED meter to find locations with low signal strength that could potentially cause problems. You can also monitor the signal through a headset connected to the mixer, if the receiver has been connected to it.

If you are using remote antennas (with the XD-AD8 antenna distribution system), you can reposition them to obtain better coverage and improve or eliminate areas with lower signal strength. With the antennas connected to the receiver, you can place it where it has better line-of-sight to the transmitter.

**Note:** If there are still spots where poor signal reception occurs, mark the problem areas on the floor with removable tape and let the user know to avoid those areas.

## Avoiding WiFi Interference

If you see moderate to strong interference on one or more channels as shown by the RF LEDs turning red when the transmitter is off, it is likely that you are seeing a WiFi channel that is operating in the same location. If you can locate that equipment and position your receivers farther from it, or relocate the receiver antennas farther from it if using an antenna distribution system, the interference may lessen in strength. Also be aware that your transmitters may interfere with the WiFi network operation if they are transmitting close to the routers. The best option when you see strong interfering signals is to use the other available Line 6 channels that are clear.

The most commonly used WiFi channels (note that their numbering does not correspond with Line 6 channels) are channels 1, 6, and 11. These channels each cover 20 MHz of spectrum, and usually only one WiFi channel will be in use in a location. In the majority of cases, any of the Line 6 wireless channels will be compatible with existing WiFi with minimal to no interference, and in all cases you will be able to use six to eight channels of Line 6 wireless while completely avoiding the WiFi channel. Use the channels in the following chart.

Channel	Frequency A	Frequency B	Compatibility
1	2425	2475	Compatible with WiFi 1, 6, & 11
2	2422	2472	Compatible with WiFi 1, 6, & 11
3	2402	2450	Compatible with WiFi 1, 6, & 11
4	2447	2478	Compatible with WiFi 1, 6, & 11
5	2428	2453	Compatible with WiFi 1, 6, & 11
6	2430	2461	Compatible with WiFi 1
7	2433	2467	Compatible with WiFi 1
8	2436	2469	Compatible with WiFi 1
9	2413	2456	Compatible with WiFi 6
10	2416	2458	Compatible with WiFi 6
11	2407	2464	Compatible with WiFi 6
12	2405	2439	Compatible with WiFi 11

**Note:** Cellular phones with Bluetooth or WiFi capabilities transmit signals in the 2.4 GHz band, so are a potential source of interference when near the receiver antennas. Use these functions of your phone at least a few feet away from the receivers when you are operating the wireless system.

## MINIMIZING NEAR / FAR TRANSMITTER EFFECTS

Line 6 digital wireless systems are designed so that a receiver only passes audio from a transmitter that is set to the same channel. While other nearby transmitters and RF sources will not create audio in a receiver not on their channel, under certain conditions they can have an effect on range. When you are using several channels of wireless, following some simple procedures will minimize any near / far effects.

The Relay G55 receiver constantly monitors the signal from its transmitter, and increases gain (sensitivity) as the transmitter moves farther away to maintain a good RF signal level. The near / far effect can happen when the transmitter is at a distance from the receiver's antennas, and transmitters on different channels are being used near the antennas. The strong signal from the nearby transmitters, especially if they are close in frequency to the channel the receiver is set on, can mask the signal from the distant transmitter – and sometimes cause the audio from that transmitter to drop out.

For example, if the transmitter on the same channel as the receiver is 50 feet away, and another transmitter is 3 feet from the receiver's antenna, the range of that distant transmitter might be affected. Avoid this potential problem by positioning the receivers and their antennas at a more equal distance from the transmitters that are in use.

### Solutions include:

- Making sure that any transmitter is at least 6 feet away from the receivers, and that other RF sources (such as WiFi routers) are also at a distance from them.
- Placing the antennas higher, which can lessen the difference in distance as well as increase line-of-sight with the distant transmitter.
- Using remote antennas (with the XD-AD8 antenna distribution system) and placing them approximately equidistant from each group of transmitters (for example, positioning a remote antenna connected to **Antenna A** nearer to the closer transmitters, and one connected to **Antenna B** nearer to the distant transmitters).
- Moving the receiver associated with the distant transmitter closer to it.

## ANTENNA MOUNTING AND PLACEMENT

The Relay G55 receiver is typically used stand-alone, though two will fit side-by-side on a rack tray. When used by itself and placed on a surface, the antennas are mounted on the rear and connected to the BNC connectors labeled **Antenna A** and **Antenna B**. Multiple receivers can share one pair of antennas by using the XD-AD8 antenna distribution system and P180 directional or P360 omnidirectional remote antennas.

**Note:** When rack-mounting receivers, it is preferable to keep them – and their associated antennas – toward the top of the rack so that line-of-sight to the transmitters is unobstructed for the best range and performance. Also, keep receivers and equipment such as digital signal processors, computers, WiFi wireless routers, and other devices that emit RF energy as separate from each other as possible.

Remote antennas become important especially when the distance is significant between the transmitters and receivers, there are walls or other obstacles between them, or when the receivers are “permanently” mounted in an equipment room or production vehicle and the transmitters are used at various and changing locations and distances.

To connect remote antennas to receivers via the XD-AD8, use low-loss 50-ohm coaxial cable with the appropriate BNC connector on each end. Place the antennas with clear line-of-sight to the location where the transmitters will be used; the Line 6 active antennas provide the convenience of mic stand mounting. Attach one end of the cable to the antenna, and run it the shortest possible distance to the antenna distribution system, and from there to the **Antenna A / Antenna B** connectors on the back of the receiver.

**Note:** As the RF signal travels through the cable to the receiver, there will be some loss of signal level, which at greater lengths and with higher loss cables can be significant. With a passive antenna, use the lowest loss cable you can find and try not to exceed about 15 feet of length. With an active antenna that provides additional gain, set it to the proper amplification for the cable length, and try not to exceed 100 feet of cable.

When used properly, remote antennas can increase range and lessen dropouts and interference conditions, compared with having the half-wave antennas directly connected to the receiver. This is especially true when the receivers must be located in a non-line-of-sight position or behind obstacles.

Omnidirectional antennas are best applied when the users will be transmitting from a wider area – in front, to the sides, and even behind the antenna. Directional antennas provide greater signal strength at the front of the antenna, and greater rejection of the signal at the rear – in the case of the P180, a cardioid coverage pattern of approximately 90 degrees with a rolloff to the sides. Use them when the users are in a more confined area or not roaming as much. They can also be used to minimize an interfering signal source by facing the back of the antenna toward the interferer and the front toward the transmitters.

# APPENDICES

## Troubleshooting

Problem	Solution
<b>No Audio</b>	Switch on transmitter and/or receiver Change transmitter batteries Confirm proper polarity of batteries in transmitter Transmitter audio muted; press MUTE button to unmute Transmitter and receiver are on different channels; set to same channel Receiver not connected to audio system, or audio system off or muted
<b>Transmitter Stays On</b>	Transmitter locked; unlock and then turn off
<b>Shorter Range</b>	Antennas not connected to receiver; check connections Receiver antennas not in line-of sight; raise them or clear obstructions Interference from other source; change channel and see Near / Far in manual Place receiver / receiver antennas farther from WiFi or other 2.4 GHz source
<b>Signal Dropouts</b>	Too great a distance between transmitter and receiver; move them closer Remote the antennas closer to transmitter (with XD-AD8 antenna distribution) Keep receiver / antennas higher in line-of-sight; no doors or walls obstructing

## Changing Transmitters from RF2 (default Relay G55) Mode to RF1 Mode

TBP12 Bodypack transmitters operate in a two-frequency mode, where the digital audio signal is encoded onto two RF carriers at different center frequencies; this provides redundancy and reliability even when interfering signals are present. The older Line 6 digital wireless systems, such as the Relay G90, used a four-frequency transmission mode.

### TBP12 Bodypack

- With the transmitter on, hold the **Select** button until the channel number flashes.
- Press and hold the **On/Mute** (power) button and then quickly press the **Select** and **Value**; press within one second, as waiting longer may turn off the transmitter.
- Note that the top line of the LCD display changes temporarily to [RF-1] in place of [CH], indicating that the transmitter is now in a transmission mode that is compatible with Relay G90 and Relay G30 receivers.
- To return to the RF2 transmission mode, repeat the above process of pressing the power button quickly followed by the **Select** button from the [CH] page. The top line of the display will temporarily show [RF-2] to indicate the mode change.
- Note that the transmission mode that is set in this manner will be remembered when the transmitter is powered off.

# Relay G55 Digital Wireless System Specifications

## System

Frequency Band	2.4GHz ISM Band
Compatible Channels	12
Spatial Diversity with Digital Buffering	Yes
Frequency Diversity	Yes (2 Frequencies per channel)
Companion-Free Design	Yes
Frequency Response THD %	10 Hz (-0.5 dB) - 20kHz (-2.5 dB) 0.03% typical
System Latency	< 2.9 ms (audio input to output)
Operating Temp Range	0 – 50 degrees C
<b>Construction</b>	
Relay G55 Receiver	Extruded aluminum chassis
TBP12 Transmitters	Metal enclosure

## Receiver

RF Performance Monitoring	Yes (via LCD screen and LED)
RF Signal Strength Indicators	5-Segment LED
Audio Level Meter (on Receiver)	5-Segment LED
Dynamic Filter	Yes
Squelch & Pad adjustments	None required
Number of Receiver Antennas	2
Receiver Format	1/2 RU (with included rack-mount kit)
Receiver Power Requirements	9Vdc 500mA
Output Impedance	XLR: 150 Ohms Balanced 1/4": 1 kOhm Unbalanced
Sensitivity	-95 dBm
Image Rejection	56 dB
Antenna Distribution	A and B
Antenna Impedance	50 Ohms

## Transmitters

Transmitter RF Output Power	10 mW
Battery Life	8 hours
Batteries	2 x AA Alkaline
Battery Display (on Transmitter)	LCD Screen
Dynamic Range	>117 dB
TBP12 Maximum Audio Input Level	6.5 Vpp
TBP12 Bodypack Input Impedance	1.3 M Ohms
TBP12 Bodypack Supplied Bias Voltage	5 VDC (on Pin 2 of TA4F Connector)
Transmitter Audio Polarity	Positive pressure on mic diaphragm produces positive voltage

### Pinout To TA4F Connector

- 1 = Ground
- 2 = Positive Voltage
- 3 = Signal





