

KRK 10s SUBWOOFER
USER GUIDE



IMPORTANT SAFETY INSTRUCTIONS



CAUTION
RISK OF ELECTRIC SHOCK DO NOT OPEN

ATTENTION:
RISQUE DE CHOC ELECTRIQUE NE PAS OUVRI



CAUTION: TO REDUCE THE RISK OF ELECTRIC SHOCK, DO NOT REMOVE COVER (OR BACK). NO USER SERVICEABLE PARTS INSIDE. REFER SERVICING TO QUALIFIED SERVICE PERSONNEL.

Warning: To reduce the risk of fire or electric shock, do not expose this unit to rain or moisture.



The lightning flash with an arrowhead symbol within an equilateral triangle, is intended to alert the user to the presence of uninsulated dangerous voltage within the product's enclosure that may be of sufficient magnitude to constitute a risk of electric shock to persons.



The exclamation point within an equilateral triangle is intended to alert the user to the presence of important operating and maintenance (servicing) instructions in the literature accompanying the product.



Do not place this unit on an unstable cart, stand or tripod, bracket or table. The unit may fall, causing serious injury to a child or adult and serious damage to the unit. Use only with a cart, stand, tripod, bracket or table recommended by the manufacturer or sold with the unit. Any mounting of the device on a wall or ceiling should follow the manufacturer's instructions and should use a mounting accessory recommended by the manufacturer.

An appliance and cart combination should be moved with care. Quick stops, excessive force and uneven surfaces may cause the appliance and cart combination to overturn.

1. "An apparatus with Class I construction shall be connected to a mains sockets outlet with protective earthing connection."
2. "Where the mains plug or an appliance coupler is used as the disconnect device, the disconnection device shall remain readily operable."
3. "IA fuse is used to US market, voltage will be set to 115V before shipment; 500mA fuse is used to European market, voltage will be set to 230V before shipment."

Read and follow all the safety and operating instructions before connecting or using this unit. Retain this notice and the owners manual for future reference.

All warnings on the unit and in its operating instructions should be adhered to.

Do not use this unit near water; for example, near a bath tub, washbowl, kitchen sink, laundry tub, in a wet basement or near a swimming pool.

The unit should be installed so that its location or position does not interfere with its proper ventilation. For example, it should not be situated on a bed, sofa, rug or similar surface that may block the ventilation openings; or placed in a built-in installation, such as a bookcase or cabinet, that may impede the flow of air through its ventilation openings.

The unit should be situated from heat sources such as radiators, heat registers, stoves or other devices (including amplifiers) that produce heat.

The unit should be connected to a power supply outlet only of the voltage and frequency marked on its rear panel.

The power supply cord should be routed so that it is not likely to be walked on or pinched, especially near the plug, convenience receptacles, or where the cord exits from the unit.

Unplug the unit from the wall outlet before cleaning. Never use benzene, thinner or other solvents for cleaning. Use only a soft damp cloth.

The power supply cord of the unit should be unplugged from the wall outlet when it is to be unused for a long period of time.

Care should be taken so that objects do not fall, and liquids are not spilled into the enclosure through any openings.

This unit should be serviced by qualified service personnel when:

- A. The power cord or the plug has been damaged; or
- B. Objects have fallen, or liquid has been spilled into the unit; or
- C. The unit has been exposed to rain or liquids of any kind; or
- D. The unit does not appear to operate normally or exhibits a marked change in performance; or
- E. The device has been dropped or the enclosure damaged.



ATTENTION

POUR ...VITER LES CHOC ELECTRIQUES, INTRODUIRE LA LAME LA PLUS LARGE DE LA FICHE DANS LA BORNE CORRESPONDANTE DE LA PRISE ET POUSSER JUSQU'AU FOND.

CAUTION

TO PREVENT ELECTRIC SHOCK, MATCH WIDE BLADE OF PLUG TO WIDE SLOT FULLY INSERT.

If an indoor antenna is used (either built into the set or installed separately), never allow any part of the antenna to touch the metal parts of other electrical appliances such as a lamp, TV set etc.

CAUTION POWER LINES

Any outdoor antenna must be located away from all power lines.

OUTDOOR ANTENNA GROUNDING

If an outside antenna is connected to your tuner or tuner-preamplifier, be sure the antenna system is grounded so as to provide some protection against voltage surges and built-up static charges. Article 810 of the National Electrical Code, ANSI/NFPA No. 70-1984, provides information with respect to proper grounding of the mast and supporting structure, grounding of the lead-in wire to an antenna discharge unit, size of grounding conductors, location of antenna discharge unit, connection to grounding electrodes and requirements for the grounding electrode.

- a. Use No. 10 AWG (5.3mm²) copper, No. 8 AWG (8.4mm²) aluminum, No. 17 AWG (1.0mm²) copper-clad steel or bronze wire, or larger, as a ground wire.
- b. Secure antenna lead-in and ground wires to house with stand-off insulators spaced from 4-6 feet (1.22 - 1.83 m) apart.
- c. Mount antenna discharge unit as close as possible to where lead-in enters house.
- d. Use jumper wire not smaller than No.6 AWG (13.3mm²) copper, or the equivalent, when a separate antenna-grounding electrode is used. see NEC Section 810-21 (j).

EXAMPLE OF ANTENNA GROUNDING AS PER NATIONAL ELECTRICAL CODE INSTRUCTIONS CONTAINED IN ARTICLE 810 - RADIO AND TELEVISION EQUIPMENT.

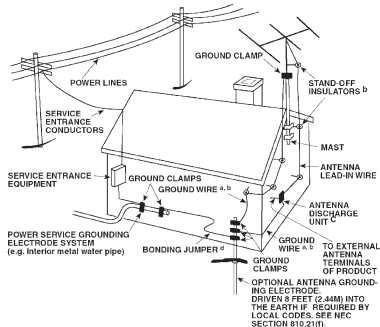

NOTE TO CATV SYSTEM INSTALLER: This reminder is provided to call the CATV system installers attention to Article 820-40 of the National Electrical Code that provides guidelines for proper grounding and, in particular, specifies that the ground cable ground shall be connected to the grounding system of the building, as close to the point of cable entry as practical.

DO NOT ATTEMPT SERVICING OF THIS UNIT YOURSELF. REFER SERVICING TO QUALIFIED SERVICE PERSONNEL

Upon completion of any servicing or repairs, request the service shops assurance that only Factory Authorized Replacement Parts with the same characteristics as the original parts have been used, and that the routine safety checks have been performed to guarantee that the equipment is in safe operating condition. REPLACEMENT WITH UNAUTHORIZED PARTS MAY RESULT IN FIRE, ELECTRIC SHOCK OR OTHER HAZARDS.

World Class Performance in Studio Reference Monitors

KRK's industry-leading line of studio monitors and subwoofers provide a level of precision and performance unheard of in monitor systems. Your KRK10s subwoofer features several key design elements that have come to be recognized as the "studio standard" for the world's finest engineers, producers, and musicians. Your KRK subwoofer delivers world-class performance—at a price that makes this a truly uncommon value.

Contents

| | |
|---|----|
| Introduction | 1 |
| Unpacking | 2 |
| KRK Systems' Design Philosophies | 3 |
| System Controls | 5 |
| Connecting Your System | 6 |
| Hooking Up Your Subwoofer: Stereo Systems | 7 |
| Subwoofer Placement and Set Up | 9 |
| Hooking Up Your Subwoofer: 5.1 Surround | 11 |
| Bass Management Theory | 13 |
| Removing the Subwoofer Grill | 14 |
| Troubleshooting | 15 |
| Specifications | 18 |

Introduction

Congratulations! Welcome to the latest KRK subwoofer series which includes the KRK10s. This KRK subwoofer series provides even better performance and accuracy, raising the bar once again above the competition. We aren't the new standard. We have always been the standard among the world's finest engineers, producers, musicians and DJs.

This manual is intended to inform you of the many features of your new KRK subwoofer and its operation. We encourage you to take a few minutes to familiarize yourself with the information in this manual. Thank you for choosing KRK!

SAFETY: For your safety and to ensure correct operation of this product, please take a moment to read the **IMPORTANT SAFETY PRECAUTIONS** section.

CAUTION: Never remove the rear panel of the subwoofer. To do so could result in electric shock. A qualified technician should perform any repair or service to the electronics.

This product is capable of producing sounds at a volume that could potentially be damaging to hearing and result in permanent hearing loss over an extended period of time.

IMPORTANT NOTE: Unpacking and Visual Inspection

Your KRK subwoofer was originally packaged in a specially designed carton with packaging materials designed specifically for this unit. Please save these items. They should be used when transporting or shipping your subwoofer. These will help preserve your warranty.

Unpacking

Your new subwoofer has been carefully inspected and tested prior to packing and shipping. After unpacking your subwoofer, carefully inspect it for exterior damage and immediately report any physical damage during transit to your shipping carrier. Save the shipping boxes and all packaging materials in case the unit needs to be returned to your local dealer or Gibson Pro Audio.

Please read the warranty card that was included in the shipping carton with your product before shipping to KRK Systems. A Return Material Authorization (RMA) from KRK Systems is required before shipping a product to KRK Systems for repair. After obtaining a RMA from KRK Systems, all KRK Systems products in need of repair can be returned to Gibson Pro Audio.

- For the safest possible return to KRK, please use the shipping carton and packaging materials that were originally provided with your subwoofer.
- KRK cannot be responsible for any damages incurred during the shipping process due to poor packing. Make certain to insure your shipment.
- If your subwoofer is out of warranty, Gibson Pro Audio's Customer Service Department can help direct you to a KRK authorized service center.
- For service or replacement parts information please call KRK Customer Service (1-800-444-2766 or service@gibson.com).

KRK Systems' Design Philosophies

Thank you for purchasing the KRK10s active studio subwoofer. We are the most dedicated monitor company in the world and we are thrilled you have joined our ever-growing family of loyal customers.

Our Focus is Your Mix

At KRK, our focus has always been to make the most accurate studio monitors available at any price.

We don't offer PA gear, mixers or motorcycles – just the tools you need to deliver a great mix. From the legendary Exposé Series, to the new VXT to the RoKit Generation 2 ("G2") series – we know recording monitors.

We do not add sonic characteristics like some other manufacturers that make their monitors appear to provide more SPL or add low frequencies that demo well in the store.

When you use a KRK monitor, you can be confident that your mixes will translate well to the wide variety of playback conditions that can occur in the real world. We want your audio mixes to sound good everywhere – not just in your studio!

Port Design

Our ports are designed to greatly reduce air flow turbulence for high performance audio reproduction. The result? Clear, accurate and well designed low frequency extension.

Even More Accurate than Before

We tweaked our speaker voicing to provide even more accurate frequency response for amazing audio reproduction using our custom made KRK drivers. What you hear is what you get, where ever your music is being played. Our drivers are all custom-designed by our world-class studio monitor engineering team.

Imitation but not Perfection – A Statement to our Competition

If the sincerest form of flattery is imitation, we must own that aspect of the recording monitor world. From using Kevlar in driver designs to copying our radiused edge approach, the competition knows a good thing when they hear it. However, chasing our past won't deliver a product that comes close to the sound of a KRK monitor. See ya later competition!

Enough About Us – Let's Get Going!

So enough about why we do the things we do. Let's read on about the features of your new KRK subwoofer so you can start enjoying your new subwoofer now!

KRK's ERGO Room Correction System



KRK provides a stand alone, high performance room correction system called ERGO. ERGO provides the ability to use up to two subwoofers with dedicated crossover functionality and delay compensation. For more information about using ERGO with your monitoring system please visit our website at www.krksys.com.



Volume



The input sensitivity is adjusted (counterclockwise reduces sensitivity) with the rear panel mounted Volume control. Adjustment range is from -30dB to +6dB. Factory preset gain is +6dB. You may need to adjust this to match the level of your monitors.

Low-Pass Frequency Adjustment



Low-Pass Frequency adjustment is performed through a continuously variable adjustment. The range is from 50Hz to 130Hz. If you are using the Subwoofer Line Outs for the monitors, you will want to place this at the 80Hz position (see additional information in the **Installing Your Monitors** section).

Phase Switch

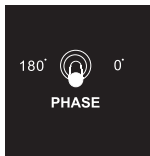

Functionally, the Phase switch is a polarity inversion mechanism whose position affects the phase relation of the subwoofer output to the other speakers in your room. The proper switch position of 0 or 180 degrees depends on a number of variables. These variables include, the distance of the subwoofer from the listening position and monitors, as well as the system's absolute polarity and the bass response of the room (refer to the **Subwoofer Setup and Placement** section in order to determine the correct switch position for your monitoring system and room).

Using the Ground Lift



Engaging the ground lift switch can sometimes reduce ground loop noise in your system. By providing an AC mains ground on the KRK10s and proper installation in a 'quiet studio' environment, the system is happily quiet. However, noise will be induced if the monitor is installed in less than desirable settings (i.e. audio cables run alongside power cables, behind refrigerators, near florescent lighting, older buildings with bad wiring), or with certain equipment with lots of Radio Frequency Interference (RFI) (lap-top supplies, PCs, generator supplied AC lines). This is because there is a ground loop through the sub panel, mains wiring, source, and back to the subwoofer on Pin-1 of the Audio inputs. Ground currents traveling through this loop impose different voltages along the path at different gain stages within the circuitry, thus creating noises.

The Ground lift switch does not affect the AC mains/panel safety ground. It does not 'open' the connection thru Pin-1 to the panel, but increases the resistance (from zero ohms to one thousand ohms) to reduce the ground current and induced noises. Safety is not affected.

Connecting Your System

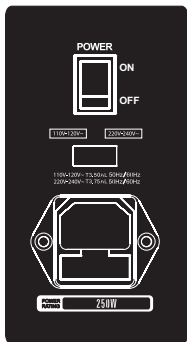

IMPORTANT: All connections should be made, all fader and controls should be set at their minimum levels, and all other equipment should be powered prior to powering up your KRK10s subwoofer. If you are connecting the sub's Line Outs to your monitors, turn monitor power on after the subwoofer.

NOTE: Ensure that the voltage indicator found in the voltage selector is set to the correct voltage setting for your local supply, and the appropriate fuses are being used (See **Specifications** on page 18).

Powering On

The power On/Off switch is located on the rear panel. The triangle in the KRK logo on the rear plate illuminates when power is applied. If a red LED is seen instead of green, this means the unit must be serviced by an authorized KRK service technician (see page 16 for more information).

Changing Voltage

To change the voltage, remove the power cord and slide the voltage selector to the desired voltage setting. Please note that when making voltage changes, the fuses will have to be replaced (refer to the **Changing Fuses** section below).

Changing Fuses

Under normal operation the fuses should not blow. A blown fuse usually indicates an overload or fault condition. To change the fuse, remove the power cord, pry off the fuse block with a small flathead screwdriver, and change the blown fuses. Refer to the **Specifications** section on Page 18 for fuse current ratings.

NOTE: If the fuses blow immediately upon power up, this indicates a fault condition. Please call KRK Customer Service (1-800-444-2766) or email service@gibson.com.

Audio Inputs

The XLR and TRS are +4 dBu balanced inputs whereas the RCA inputs are -10 dBu unbalanced.

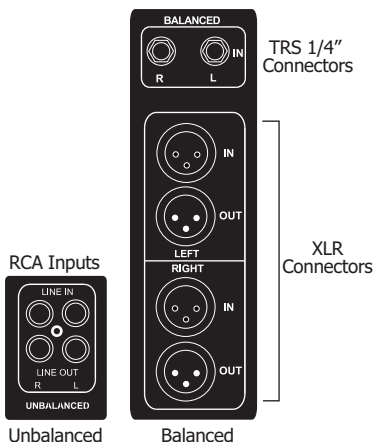

Audio Input

10k Ohms Balanced
Pin 2 + Tip = High
Pin 3 + Ring = Low Pin
Pin 1 + Sleeve = Ground

Hooking Up Your Subwoofer: Stereo Systems

KRK subwoofers include a built-in crossover and amplifier, so you only need the appropriate hook up cables to integrate it into your existing monitor system. First, you'll need to connect a pair of cables from the stereo monitor outputs of your console or audio hardware device to the left and right XLR, 1/4" or RCA input jacks on the subwoofer. Next, if you are using the internal 80Hz high-pass filter built into the subwoofer for the existing full-range monitors (and most of you will), hook the left and right XLR or RCA output jacks on the subwoofer to the corresponding line-level inputs of your powered full-range speakers or stereo amplifier.

| Pin-2 Hot | | |
|----------------|----|--|
| Pin 1 (Shield) | to | Sleeve (Shield) |
| Pin 2 | | Tip |
| Pin 3 | | Ring (On Stereo Plug) or Sleeve (On Mono Plug) |

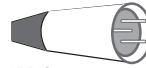

XLR Connector

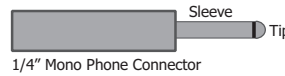

1/4" Mono Phone Connector



1/4" Stereo Phone Connector, TRS (Tip/Ring/Sleeve)

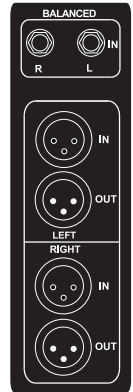

Subwoofer Hook Up with Active Monitors

If you are using active (powered) monitors, you'll first need to connect a pair of cables from the stereo monitor outputs of your console or audio hardware device to the Left and Right XLR, 1/4", or RCA input jacks on the subwoofer. Next, simply use XLR or RCA cables to connect the outputs of the subwoofer to the inputs of your monitors. The output marked "Left" should go to your left monitor, and the output marked "Right" should go to your right monitor.

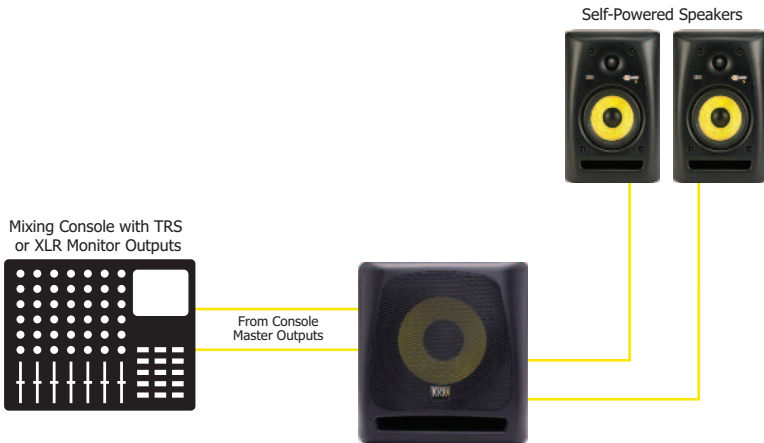

Figure 1

Subwoofer Hook Up with Passive Monitors

If you are using passive (non-powered) monitors that require an external amplifier, you'll first need to connect a pair of cables from the stereo monitor outputs of your console or audio hardware device to the left and right XLR, 1/4", or RCA input jacks on the subwoofer. Next, connect the outputs of the subwoofer to the corresponding inputs of the stereo amplifier. Typically, this connection would also be an XLR connector, but you can use the RCA outputs on the subwoofer if the amplifier is similarly equipped. Connect the passive monitors to the power amplifier as your normally would. Do not attempt to connect the speaker output of the monitor amplifier to the input of the subwoofer - by doing so you run the risk of damaging the equipment.

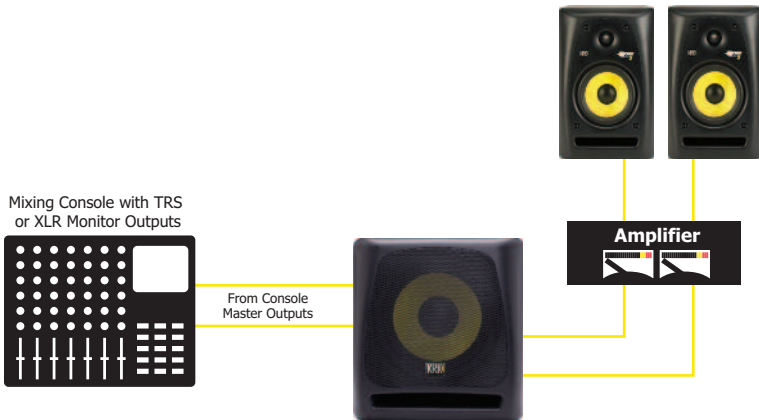

Figure 2

Subwoofer Placement and Set Up

A properly set up subwoofer system extends the bass response of the main monitors (either stereo or 5.1 surround) without exaggerating bass response in the room. Improper set up may cause an exaggeration of bass response in the room, which in turn may cause the engineer to mix in less bass energy than desired.

There are some basic steps necessary to ensure you have a subwoofer operating in top form: 1) a room correction system such as KRK's ERGO and/or room treatment; 2) proper placement of the sub within the room; and 3) proper electrical settings.

Proper Physical Placement of Subwoofer

Just because bass frequencies are largely non-directional does not mean that you can ignore the subwoofer's placement in the room. In fact, a sub's physical position in the room in relation to the floor, walls and other surfaces radically influences its bass response. In a monitoring situation, it is desirable to place the subwoofer so that it produces the smoothest frequency response at the listening position. In addition, since the subwoofer's output will interact with the other monitor speakers in the room, it is important to consider the subwoofer and near-field speakers as a total system.

At this stage, you have only the subwoofer operating. Once you find its optimum position and settings, you can turn on the complete monitoring system to verify that all components interact properly. What you are attempting to do is find a place in the room where the subwoofer interacts smoothly with the acoustics to even out the bass response at the listening position.

Once you find the optimal spot, place the subwoofer there and listen to it from the mix position. Move the subwoofer around a foot at a time until the bass response is as even as possible at the listening position. Remember that you do not want any single frequency to be exaggerated during monitoring, as that will result in the final music mix having too little bass. One caveat: if your subwoofer's optimum position is under your console, make sure to leave the removable grill on the subwoofer to protect the speaker from your feet. You do not want to kick a hole in the subwoofer speaker.

Continue to the next section (**Setting Subwoofer Levels**) in order to determine the proper position of the phase switch on the subwoofer.

Setting Subwoofer Levels

Once the subwoofer is in position, its level needs to be matched with the near-field monitors. For stereo systems, the process is straightforward. Obtain a SPL (Sound Pressure Level) meter or use a smartphone app. If you will be using the internal high-pass filtered outputs from the subwoofer to the near-field speakers, as most of you will, set the low-pass filter on the KRK subwoofer back panel to 80Hz.

Next, route a band-limited pink noise tone through the system, including satellite speakers (these test tones are available on the KRK website - see download link at the bottom of this page). 500Hz to 1kHz is within the fundamental frequency range of many vocalists and will allow you to set the volume of the satellites without exciting the subwoofer. Using an SPL meter or smartphone app, set the overall volume so that the sound level is something comfortable - around 85dB using the 'C' response curve on the SPL meter.

Run another band-limited pink noise tone of 35-75Hz through the system and set the volume on the sub to where it's reading 85dB on the SPL meter. This band is below the 80Hz frequency of the subwoofer high-pass filter, but sufficiently high enough that most subwoofers will have adequate response in that range.

Set the low pass crossover on the subwoofer to 130Hz, allowing bass energy between the near-field monitors and subwoofer to overlap. Run a band-limited pink noise tone from 60-120Hz, and from the listening position determine if 0 or 180 on the phase switch is loudest. Leave the switch in the loudest position - the loudest position is correct and in phase. Now return the low-pass filter to the 80Hz position (or the appropriate frequency if you are using external high-pass filters for the near-field monitors). Your subwoofer should now be aligned for phase, sound level, and spectral response.

Using the Bypass Feature

Your KRK subwoofer is equipped with a bypass feature, which allows you to defeat the sub and, in instances where the sub's Line Outputs are being utilized, provide full range audio to your monitors at the same time. This feature is of great benefit in that the internal high-pass filter is bypassed, allowing full bandwidth to run to the monitors while simultaneously muting the sub. You may then evaluate the impact of the subwoofer on your mix. To utilize this feature, connect a standard latching footswitch with a 1/4" mono phone plug to the 1/4" "Sub & HPF Bypass" connector on the back panel of the subwoofer. Any standard latching 1/4" mono footswitch (such as the Boss FS-5L or KRK KFS-1) should be compatible. Please note that the KRK10s does not support the LED indicator feature on the footswitch model KRK KFS-1.

Download subwoofer test tones from the KRK website:
www.krksys.com/krk-media-downloads.html

Hooking Up Your Subwoofer: 5.1 Surround

This is a bit more involved than a stereo hook up since there are now six speakers involved—as well as something called Bass Management (see the **Bass Management Theory** section). Notice from Figure 3 that for professional use a separate 6-channel level control box is required between the mix-down deck and the monitor speakers. This is because few small format mixing consoles have provisions to switch and level-manage a 6-channel audio signal. The simplest and perhaps best way to accomplish this is to use an external, 5.1 level controller. It is placed between the outputs of the mix-down deck and the monitor speakers, allowing it to control the playback level while the mix-down deck receives full-level recording signal.

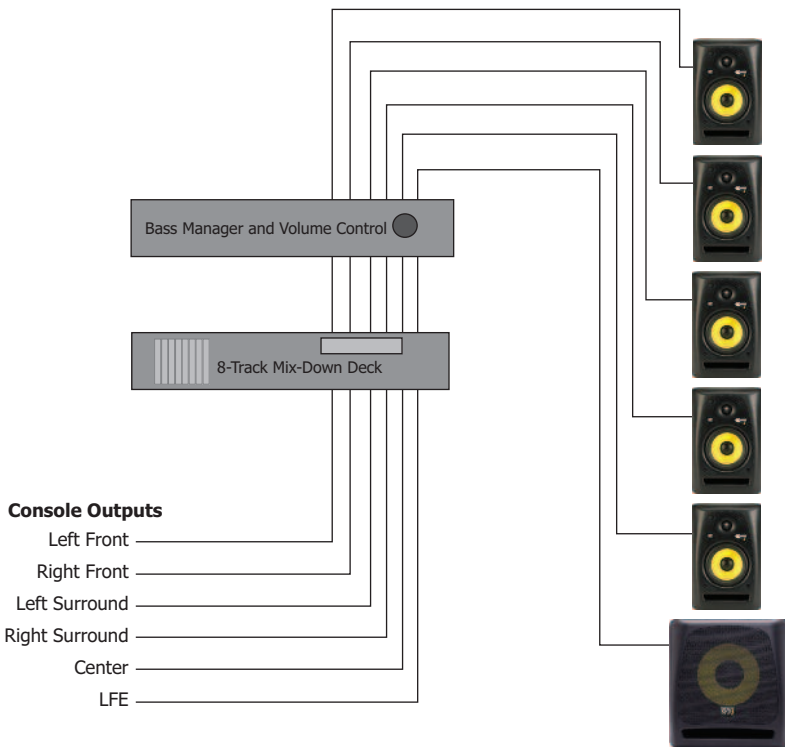

Figure 3

Beyond Stereo to 5.1 Surround

When using a subwoofer for the LFE (Low Frequency Effects) channel in a 5.1 surround monitoring system, rotate the low pass filter all the way to the right to the 130Hz position. Note that the LFE channel is set with an additional 10dB of monitoring gain. To set this level, we recommend using 2-octave wide, band-passed, pink noise from 20 to 80Hz for the LFE channel and 500 to 2,000Hz for the near-field speakers. After adjusting each near-field monitor one at a time to 85dB SPL, adjust the LFE channel 10dB louder to 95dB SPL.

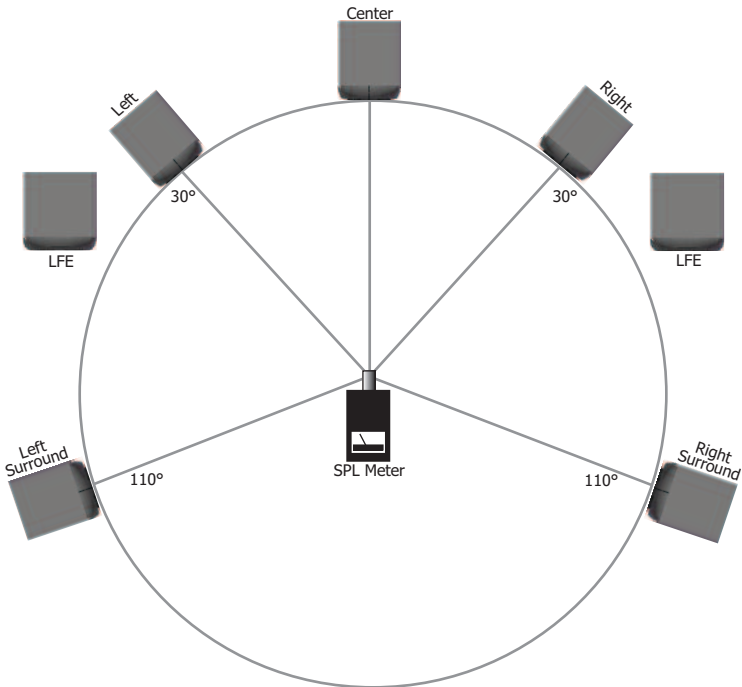

Figure 4

Bass Management Theory

Bass management is a method for extending the bass response of small, near-field speakers used in 5.1 surround sound systems (familarly called home-theatre systems). This is done by routing frequencies below a cutoff point to a separate subwoofer (sometimes called "bass redirection" in home-theater receivers). This can usually be enabled by selecting "Small Speakers" from a speaker set up menu. This process places a group of two-way filters in the speaker output path, typically at 80Hz. These filters route all sonic energy above this given frequency (e.g. 80Hz) to the Left, Center, Right, Left Surround and Right Surround speakers. In turn, the process redirects the low-frequency energy from the five full-range channels to a single subwoofer, which also reproduces the separate LFE channel.

Bass management is used in practically every consumer home-theater system. Therefore, audio engineers mixing for modern listeners should realize that their studio monitoring systems must be able to reproduce sufficient low frequencies so they can avoid recording undesirable subsonic information. Without such studio monitoring, it is possible to release a mix with infrasonic problems, such as pops, air conditioner rumble, traffic noise, footsteps, etc. These subsonic noises will be eliminated (masked) by the natural high-pass filter effect of using near-field monitors with a response that goes down only as low as 40 or 50Hz. Thus, infrasonic problems may not be recognized (heard) in the studio. However, since virtually all home-theatre systems use subwoofers with bass management, consumers will hear these infrasonic problems at high volume levels in their home.

Bass management effectively extends the low-frequency response of near-field monitors down well into the 25 to 40Hz range (depending on the subwoofer used). This allows the engineer to take evasive action in the studio, such as engaging high-pass filters on input channels and microphones, adding pop filters and suspension mounts to microphones and correcting HVAC and other rumble problems.

Removing the Subwoofer Grill

The subwoofer grill can be removed and the grill's rubber gasket can be reinserted to show off your KRK10s woofer. However, if you place your subwoofer in proximity to your feet we highly recommend leaving the grill on to protect the speaker!

To Remove the grill and replace the grill's rubber gasket, follow these directions:

1. Take a paper clip and bend a "tight" hook into the paper clip. You want a short hook to insert into the grill.
2. Insert the hook end of the paper clip into the grill near the edge and gently pull the grill toward you.
3. As you see the grill start to separate, repeat this procedure around the grill edge until you can easily pull the grill away from the cabinet.
4. Once you remove the grill, pull the grill's rubber gasket away from the grill.
5. Now insert the grill's rubber gasket into the groove in the cabinet that the grill came from so that the back of the gasket is facing out. This will give you a seamless edge to the gasket so that it fills the grill's groove in the cabinet.
6. Store the grill in a safe place in case you want to reinstall it later.

Troubleshooting

If you're having trouble, check out these tips...

If there is no power, check to see if...

- The power cord is plugged into both the IEC socket on the rear panel of the unit and into the AC mains.
- The AC mains voltage is matched to the operating voltage requirements (see **Changing Voltage** in the **Connecting Your System** section on page 6). If the AC mains voltage is higher than the selected voltage, it is possible that the fuse needs to be replaced (see **Changing Fuses** in the **Connecting Your System** section on page 6).
- The power light is illuminated on the front panel of the monitor or on the back panel of the subwoofer. Note that with the the new RoKit series (Generation 2) or the VXT series, the logo illuminates on the front panel to indicate that power is on. If the power indicator is not on, turn the power switch off and check the A/C mains fuse(s). **NEVER USE A LARGER AMPERAGE FUSE THAN IS SPECIFIED!** Turn the power switch back on. The power light should illuminate.
- **Note:** If a fuse change was needed (and the AV mains voltage is set correctly) yet upon powering the unit back up the fuse(s) blow again, please contact KRK Customer Service (1-800-444-2766 or service@gibson.com) for service recommendations.

If you can't hear any sound...

- Repeat the steps in the **Troubleshooting** section above before continuing to the next steps.
- Check to see if all other audio devices using the same AC outlet are still operating.
- Make sure that:
 - The audio source cable is plugged into both the source output and the unit's input.
 - The System Gain pot is turned up fully clockwise (+6dB).
 - The signal source (e.g. mixing console, work station, CD player, etc.) is turned up to a level that can properly send a signal to the monitors.
- If one of the full range monitors is working then exchange the audio input cable from the non-working monitor to the working unit. This will determine whether it's really the monitor, a faulty cable, or some other glitch in the audio chain.
- If the unit is still not responding, please contact KRK Customer Service (1-800-444-2766 or service@gibson.com) for service recommendations.

If the monitor suddenly stops working...

- Turn the unit's send down or off.
- Repeat the steps in the **Troubleshooting** sections above before continuing to the next steps.
- Carefully check to see if the amplifier's back plate is hot! If the unit has been running at highest power output for an extended period of time, it could be that it has become over heated and the protection circuitry has shut the system down momentarily. The unit provides maximum circuitry protection against AC power surges, amplifier overdrive, and overheating of the amplifiers. Turn the unit off then wait 30 minutes to allow the back plate to cool down. Turn the power switch back on.
- Increase the volume to check for normal operation.
- If the unit is still not responding, please contact KRK Customer Service (1-800-444-2766 or service@gibson.com) for service recommendations.

The sound quality changes...

- Repeat the steps in the **Troubleshooting** section above before continuing to the next steps.
- Disconnect the signal cable at the unit's input. With power on, place your ear close to each driver (tweeter/woofer) and listen for noise (i.e. a slight hiss or hum). If there's absolutely no sound whatsoever, it could be that one or more of the drivers (woofer, tweeter or both) is at fault. It's also possible that the problem lies somewhere in the electronics.
- Play some non-distorted source material at a low volume. Carefully cover the tweeter (to block the sound) without touching the diaphragm. Is the woofer producing a clean sound? If there is not a clear tonal quality, or any sound at all, then the woofer probably needs to be replaced.
- Cover the woofer so you can hear mostly the tweeter. Is the tweeter producing a clear sound? If there is not a clear tonal quality, or any sound at all, then the tweeter probably needs to be replaced.
- Once you have a better idea of what may be at fault then call us and speak with someone in the service department. They will help you determine the best solution to correct your unit. KRK Customer Service (1-800-444-2766 or service@gibson.com).

The monitor (or subwoofer) hisses, hums or makes other loud noises...

Here are some suggestions that will help you eliminate these undesirables from your system:

- Make sure that the power cord is plugged snugly into the IEC socket on the rear of the unit.
- Check the connections between the signal source and the unit. The sub and monitor's XLR and TRS connectors are a completely balanced system. If you're connecting an unbalanced output to the monitor, be sure that you're using Pin 2 for signal and have Pin 1 and Pin 3 tied together at the source end.
- Refer to the **Connecting Your System** section on page 6 of this manual to ensure that the AC mains is matched to the operating voltage requirements.
- All audio equipment should use the same ground point. Check all other devices using the same AC output in the building such as dimmers, neon signs, TV screens, and computer monitors. These devices should not be using the same circuit.

Warranty and Service Info

Please read the warranty card that was included in the shipping carton of your subwoofer. All products in need of repair can be returned to KRK/Gibson Pro Audio or to an authorized service center for service evaluations. For troubleshooting help and service assistance, please call KRK/Gibson Pro Audio Customer Service at 1-800-444-2766, or email service@gibson.com.

Before shipping your unit back to KRK for service you must acquire a Return Material Authorization (RMA) from KRK. Your unit will not be received by the company, nor will any work be done on your unit without this number.

Please call KRK Customer Service (1-800-444-2766 or service@gibson.com).

Shipping Instructions

- For the safest possible return to KRK, please use the shipping carton and packaging in which your monitor was originally shipped.
- KRK cannot be responsible for any damages incurred during the shipping process due to poor packing. Make sure to insure your shipment.
- If your subwoofer is out of warranty and you would like consultation before servicing your product, please contact KRK/Gibson Pro Audio Customer Service at 1-800-444-2766 or by email at service@gibson.com.
- For replacement part information, call 1-800-444-2766 or email service@gibson.com.

KRK10s

| | |
|-------------------------------|---|
| Frequency Response | 34Hz – 50Hz to 130Hz Variable |
| SPL | 110dB Music and 113dB Peak |
| Low Frequency Driver | 10" High Excursion Glass Aramid Composite Woofer |
| Cabinet Dimensions (HxWxD) | 15" x 14" x 16 1/16" 38.2 cm x 35.5 cm x 40.8 cm |
| Net Weight (each) | 40.2 lbs. (18.24 kgs) |

AMPLIFIER

| | |
|--------------------------|--------------|
| Power Rating | 150W RMS |
| Signal to Noise T.H.D | 98dB .08% |
| Input Impedance | |
| Balanced | 10kohm |
| Unbalanced | 10kohm |

CROSSOVER

| | |
|---------------------------|-----------------------|
| Line Out (High-Pass) | 80Hz Fixed |
| Subwoofer Low-Pass Filter | 50Hz – 130Hz Variable |
| FUSE 5mm x 20mm | |
| 100V - 120V | 4.0A - 250V Slow Blow |
| 220V - 240V | 2.0A - 250V Slow Blow |

FEATURES

XLR & 1/4" TRS Connectors
RCA Connector
IEC Mains Connector
System Volume Control
LED Power Indicator
Subwoofer/Line Out Bypass Switch
Variable Low-Pass Adjust
Ground Lift Switch



w w w . k r k s y s . c o m

Our mission is to innovate, design and deliver superior audio products
that form the bridge between an artistic vision
and a realized dream.