

# KROSS

SYNTHESIZER WORKSTATION

## Operation Guide

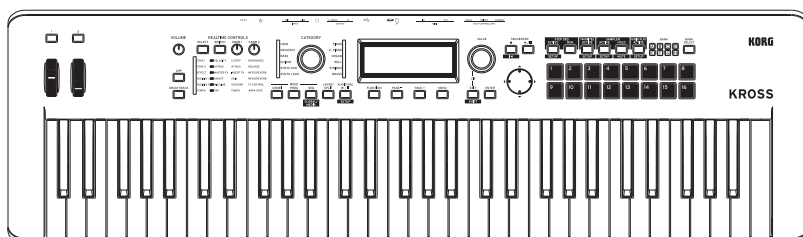
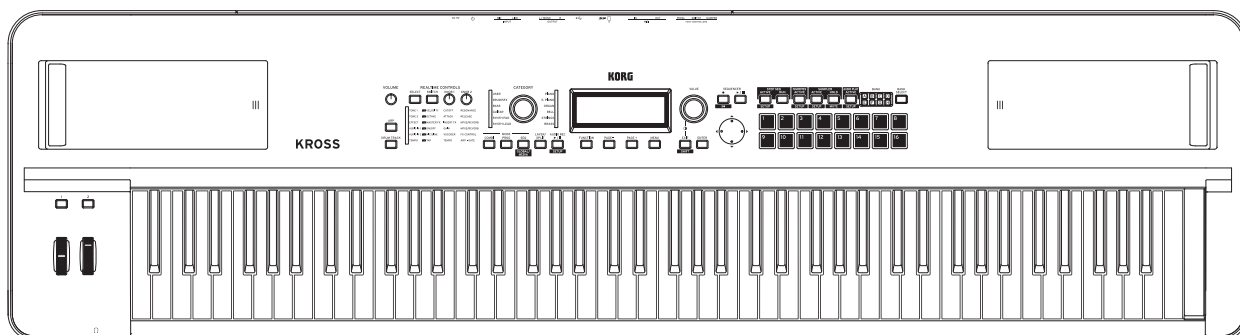

**EDS-i** Enhanced Definition  
Synthesis - integrated

**REMS** GENERAL  
**MI**

# KORG

Thank you for purchasing the Korg KROSS SYNTHESIZER WORKSTATION. To help you get the most out of your new instrument, please read.

## About this manual

### The manuals and how to use them

The KROSS comes with the following manuals.

- Quick Start Guide (printed)

The manuals listed below can be downloaded from the Korg website.

- Operation Guide (PDF) (this document)
- Parameter Guide (PDF)
- Voice Name List (PDF)
- Quick Start Guide (PDF)

You can also watch video manuals on the Korg website.

- Video manual

<http://www.korg.com/>

### Quick Start Guide

This provides a simple explanation of the KROSS's functions. To begin, please read the Quick Start Guide.

### Operation Guide (this document)

Put simply, the Operation Guide is designed to answer the question, "How do I do this?"

It explains the names and functions of each part of the KROSS, basic operation, an overview of each mode, how to edit sounds, record on the sequencer, and so on. This guide also explains the basics of effects, the Arpeggiator, Drum Track, and Drum Kits.

Finally, it also contains a troubleshooting guide as well as supplemental information such as a list of specifications.

### Parameter Guide

The Parameter Guide is designed to answer the question, "What does this do?"

Organized by mode and page, the Parameter Guide includes information on each and every parameter in the KROSS.

### Voice Name List

The **Voice Name List** lists all of the sounds and setups that are in the KROSS when it is shipped from the factory, including Programs, Combinations, Multisamples, Drumsamples, Drum Kits, Arpeggio Patterns, Drum Track Patterns, Demo Songs, and Template Songs.

### PDF versions

The KROSS PDF manuals are designed for easy navigation and searching. They include extensive PDF contents information, which generally appears on the side of the window in your PDF reader and lets you jump quickly to a specific section. All cross-references are hyper-links, so that clicking on them automatically takes you to the source of the reference.

### Video Manual

This video illustrates the main functionality of the KROSS.

### Conventions in this manual

#### References to the KROSS

The KROSS is available in 88-key, and 61-key models. The manuals refer to all models without distinction as "the KROSS."

#### Abbreviations for the manuals: PG

In the documentation, references to the manuals are abbreviated as follows.

**PG:** Parameter Guide

#### Symbols , , *Note, Tips*

These symbols respectively indicate a caution, a MIDI-related explanation, a supplementary note, or a tip.

#### Example screen displays

The parameter values shown in the example screens of this manual are only for explanatory purposes, and may not necessarily match the values that appear on the LCD screen of your instrument.

#### MIDI-related explanations

CC# is an abbreviation for Control Change Number.

In explanations of MIDI messages, numbers in square brackets [ ] always indicate hexadecimal numbers.

#### What is *REMS* ?

*REMS* (Resonant structure and Electronic circuit Modeling System) is Korg's proprietary technology for digitally recreating the numerous factors that produce and influence a sound, ranging from the sound-production mechanisms of acoustic instruments and electric/electronic musical instruments, to the resonances of an instrument body or speaker cabinet, the sound field in which the instrument is played, the propagation route of the sound, the electrical and acoustic response of mics and speakers, and the changes produced by vacuum tubes and transistors.

---

\* All product names and company names are the trademarks or registered trademarks of their respective owners.

---

# Table of Contents

<b>About this manual</b> .....	ii	An overview of the edit pages .....	35
<b>Introduction to the KROSS</b> .....	1	Basic oscillator settings.....	36
<b>Front and rear panels</b> .....	1	Creating time-varying changes (LFO and EG) .....	38
Front panel .....	1	Diverse modulation settings (AMS and AMS mixer) .....	39
Rear panel .....	6	Controlling Pitch .....	40
Items in the display .....	7	Using Filters .....	41
<b>Basic Information</b> .....	9	Using the Amp section .....	43
About the KROSS's modes .....	9	Making controller assignments .....	44
Basic operations .....	12	Arpeggiator settings .....	44
<b>Setup</b> .....	17	Drum Track settings .....	44
<b>Turning the power on/off</b> .....	17	Using the step sequencer .....	44
Connecting the AC adapter .....	17	Effects .....	44
Turning the power on .....	17	Automatically importing a Program into Sequence mode.....	44
Turning the power off .....	18	<b>Playing and editing Combinations</b> .....	45
Using batteries .....	19	<b>Playing combinations</b> .....	45
<b>Connections</b> .....	21	Selecting Combinations .....	45
Audio connections .....	21	Combination categories and numbers .....	46
Connecting foot controllers.....	23	Using controllers to modify the sound .....	46
Using an SD card .....	25	Performing with the arpeggiator, drum track or step sequencer .....	46
Connecting the KROSS to a computer .....	25	<b>Editing a combination</b> .....	47
Connecting MIDI devices .....	26	Summary of the edit pages .....	47
<b>Playing and editing Programs</b> .....	27	A suggested approach for editing .....	48
<b>Playing Programs</b> .....	27	Comparing with the sound before you started editing.....	48
Selecting Programs .....	27	Changing the program of each timbre .....	48
Program categories and numbers .....	28	Adjusting the mix .....	48
Using Controllers .....	28	Using the Tone Adjust and EG Adjust functions.....	49
Performing with the arpeggiator, drum track or step sequencer.....	28	Saving a Combination you've edited.....	49
<b>Quick Layer/Split function</b> .....	29	Using REALTIME CONTROLS to adjust the sound or effects .....	49
Quick Layer .....	29	Layers, Splits, and Velocity Switches.....	49
Quick Split .....	30	Status settings .....	51
Combination settings made by Quick Layer/Split .....	30	MIDI settings .....	51
<b>Easy program editing</b> .....	31	Changing the program settings to match the combination.....	51
Using the Tone Adjust and EG Adjust functions .....	31	Arpeggiator settings .....	52
Adjusting the volume balance .....	32	Drum Track settings .....	52
Using REALTIME CONTROLS to adjust the sound or effects.....	32	Using the step sequencer .....	52
Comparing the unedited sound .....	32	Effects .....	52
Saving your edits .....	33	Automatically importing a combination into Sequence mode .....	52
<b>Detailed Editing with Programs</b> .....	34	<b>Favorites function</b> .....	53
Before you start editing .....	34	<b>What is the Favorites function?</b> .....	53
		<b>Using the Favorites function</b> .....	53
		Recalling a favorite sound .....	53
		Registering a sound in Favorites .....	53
		<b>Convenient ways to use favorites</b> .....	54
		Specifying a program change .....	54

<b>Saving your Favorites</b> .....	<b>54</b>	<b>Drum Track function</b> .....	<b>83</b>
<b>Sequencer</b> .....	<b>55</b>	<b>Performing with the Drum Track function</b> .....	<b>83</b>
<b>Overview</b> .....	<b>55</b>	Using the Drum Track function in Program mode .....	83
About the KROSS's Sequencer .....	55	Using the Drum Track function in Combination mode .....	84
Sequencer mode structure .....	55	<b>Drum Track function settings</b> .....	<b>85</b>
<b>Playing back</b> .....	<b>56</b>	Drum Track function settings in Program mode .....	85
Playback methods .....	56	Drum Track function settings in Combination mode .....	85
<b>Recording</b> .....	<b>58</b>	Drum Track function settings in Sequencer mode .....	86
Preparations for recording .....	58	<b>Synchronizing the Drum Track function</b> .....	<b>86</b>
Recording MIDI in real time .....	61	The Trigger "Sync" parameter .....	86
Performing with the arpeggiator drum track or step sequencer .....	62	Synchronization with song stop .....	86
Recording your pad sampler performance .....	62	Slave operation .....	87
Recording System Exclusive events .....	62	Master operation .....	87
<b>Song editing</b> .....	<b>64</b>	<b>Step sequencer</b> .....	<b>89</b>
Song .....	64	<b>Performing with the step sequencer</b> .....	<b>89</b>
Tracks .....	64	Playback and settings in Program mode .....	89
<b>Saving your MIDI song</b> .....	<b>65</b>	Step sequencer settings in Combination mode .....	91
<b>Using Effects</b> .....	<b>67</b>	Step sequencer settings in Sequencer mode .....	91
<b>An overview of the KROSS's effects</b> .....	<b>67</b>	Using the step sequencer with Favorites .....	92
Effect I/O .....	67	<b>Synchronizing the step sequencer</b> .....	<b>92</b>
Effects in each mode .....	67	<b>Pad Sampler</b> .....	<b>93</b>
<b>Routing and effect settings</b> .....	<b>68</b>	<b>Performing with the pad sampler</b> .....	<b>93</b>
Effect settings for a program .....	68	Recording samples (sampling) .....	93
Effect settings for a combination or song .....	70	Editing a sample .....	95
Effect settings for audio input .....	71	Playing samples .....	96
<b>Dynamic modulation (Dmod)</b> .....	<b>72</b>	MIDI transmission and reception for the pad sampler function .....	97
<b>Arpeggiator function</b> .....	<b>73</b>	Using samples in other ways .....	97
<b>Using the arpeggiator while you play</b> .....	<b>73</b>	Exporting a sample .....	97
Using the arpeggiator in Program mode .....	73	<b>Audio recorder</b> .....	<b>99</b>
Arpeggio pattern selection and operation settings .....	74	<b>An overview of the audio recorder</b> .....	<b>99</b>
Using the arpeggiator in Combination mode .....	75	About the audio recorder .....	99
Arpeggiator settings in Combination and Sequencer modes .....	76	Basic operation .....	100
Linking the arpeggiator to programs or combinations .....	77	AUDIO RECORDER SETUP window .....	100
<b>Creating a user arpeggio pattern</b> .....	<b>78</b>	<b>Recording and playing audio</b> .....	<b>101</b>
About user arpeggio patterns .....	78	Preparations .....	101
Editing a user arpeggio pattern .....	78	Recording the performance of the KROSS .....	101
<b>Regarding arpeggiator synchronization</b> .....	<b>81</b>	Recording external audio input .....	102
"Key Sync." parameter .....	81	Playing back an audio song .....	103
		Multi-track recording .....	103
		Preparing a new audio song .....	104
		<b>Convenient functions for playback and recording</b> .....	<b>104</b>
		Returning to the state before or after recording (Undo/Redo) .....	104
		Specifying how recording will start .....	104

Loop playback .....	105	<b>Troubleshooting .....</b>	<b>132</b>
Pad audio play .....	105	Power supply .....	132
Importing or exporting WAVE files .....	105	Problems at start-up .....	132
Adjusting the volume .....	106	Basic operation (screen and functions) .....	133
SD card-related messages .....	107	Audio output .....	133
		Audio input .....	134
<b>Pad audio play .....</b>	<b>109</b>	Programs and Combinations .....	134
<b>Performing with the pad audio play function .....</b>	<b>109</b>	Sequencer .....	134
Specifying an audio song and assigning the song to a pad .....	109	Arpeggiator .....	135
Using the pads to play back audio songs .....	109	Drum Track function .....	135
		Drum Kits .....	135
		Effects .....	135
<b>Using Drum Kits .....</b>	<b>111</b>	Step sequencer .....	135
<b>Drum Kit Overview .....</b>	<b>111</b>	Pad sampler .....	135
Before you start editing .....	111	Audio recorder .....	136
<b>Editing a Drum Kit .....</b>	<b>112</b>	MIDI .....	136
		Damper pedal .....	136
		Media .....	136
		Connections with a computer .....	136
		<b>Messages .....</b>	<b>137</b>
<b>Overall settings for the KROSS, and saving/ loading data .....</b>	<b>115</b>	Error and confirmation messages .....	137
<b>How Global/Media mode is organized .....</b>	<b>115</b>	<b>Specifications .....</b>	<b>142</b>
<b>Global setting .....</b>	<b>115</b>	Operating requirements .....	144
Basic settings for the KROSS .....	115	<b>MIDI Implementation Chart .....</b>	<b>145</b>
MIDI settings .....	117		
Pedal and other controller settings .....	117		
Creating and selecting scales .....	117		
<b>Data used by the KROSS .....</b>	<b>119</b>		
<b>Saving data .....</b>	<b>121</b>		
Saving data on the KROSS .....	121		
Writing to internal memory .....	122		
Editing names .....	124		
Saving to SD card .....	125		
<b>Loading data .....</b>	<b>126</b>		
Data that can be loaded .....	126		
Loading data from SD card .....	126		
<b>Media utility .....</b>	<b>129</b>		
Formatting SD card .....	129		
Setting the current time .....	129		
<b>Appendices .....</b>	<b>131</b>		
<b>Restoring the factory settings .....</b>	<b>131</b>		
Loading the preloaded data .....	131		
Initializing the user bank .....	131		
Initializing the system .....	132		
<b>Updating the system .....</b>	<b>132</b>		



# Introduction to the KROSS

## Front and rear panels

### Front panel

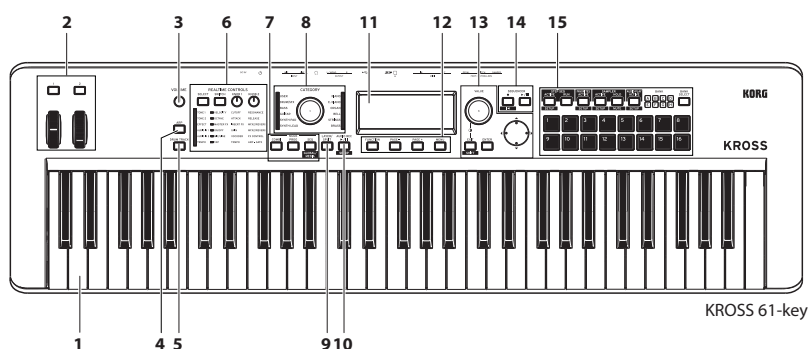

\*The battery compartment of the KROSS 61-key is located on the bottom panel.

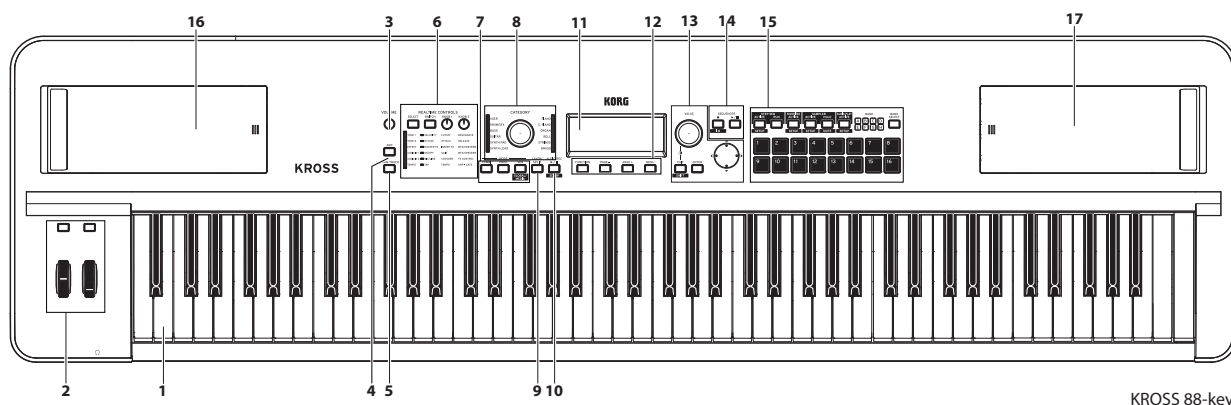

## 1. Keyboard

The KROSS 61-key has a 61-note keyboard (velocity sensitive, aftertouch not supported).

The KROSS 88-key has a 88-note natural weighted hammer-action (NH) keyboard (velocity sensitive, aftertouch not supported).

When playing these keyboards, your playing strength (velocity) can affect aspects of the sound such as the volume and the EG speed, allowing you to vary the character of the attack. (see pages 31 and 43)

You can also set keyboard tracking settings so that the sound will change as you move across the keyboard, for example by becoming brighter as you play higher notes. (see page 42)

## 2. Controllers

### SW1, SW2 buttons

You can assign various functions to the SW1 and SW2 buttons for each program, combination, or song. You can use these buttons to control program parameters via AMS (Alternate Modulation), or effect parameters via Dmod (Dynamic Modulation).

They can also transpose the keyboard by octaves, turn portamento on/off, or lock the Pitch Bend position.

Each button can work as either a **Toggle** or **Momentary** button. In **Toggle** mode, the assigned function is switched between on and off each time the button is pressed. In **Momentary** mode, the assigned function is active only as long as you hold down the button.

In Program mode, you can check the assignments of SW1 and SW2 on the PROG> MAIN page.

For details, please see “SW (Switch assignment) information” on page 28.

When you write a Program or Combination, the on/off status of the SW1 and SW2 buttons is saved.

Please see “Setting the functions of SW1 and SW2” on page 44.

### Pitch bend wheel (left)

Move this wheel forward or backward to control the pitch. The center is the normal position, where there is no pitch change. When you take your hand off of the pitch bend wheel, it will return to the center position.

The amount of pitch change can be specified individually for each program’s oscillator, combination timbre, and song track. You can also use the pitch bend lock function of the SW1 or SW2 buttons to lock the pitch so that it will stay at the position of the wheel immediately before the button was released.

### Modulation wheel (right)

Move this wheel away from yourself to control various program parameters or effect parameters. If the wheel is moved all the way

toward yourself, the effect will be zero. The modulation wheel will stay in its position when you release it, and the effect will continue.

The function that is controlled by the wheel is assigned by the program parameters or effect parameters. Although different effects are assigned for different programs and combinations, a vibrato effect which cyclically varies the pitch is typically assigned to the modulation wheel.

---

### 3. VOLUME knob

This knob adjusts the volume of the OUTPUT L/MONO, R outputs, as well as the volume of the headphone jack. (see page 17)

---

### 4. ARP (Arpeggiator) button

This button turns the arpeggiator on/off. The button will be lit up if the arpeggiator is on. (see page 73)

---

### 5. DRUM TRACK button

This button turns the Drum Track function on or off. This button also indicates the operating state of the drum track.

Unlit: off, Blinking: waiting for trigger, Lit: on (see page 83)

---

### 6. REALTIME CONTROLS

When you're playing a program or combination, you can use these to adjust the sound or the effects, or to make simple edits. Here you can also turn the external audio input on/off, adjust the vocoder function, and adjust the tempo of the arpeggiator or sequencer.

For details on operating each parameter and on saving your changes, see PG p.311.

**Note:** REALTIME CONTROLS can be used when the SELECT LED is lit. They cannot be used when the LED is unlit.

#### SELECT button, SELECT LED

This selects the functions that are controlled by the SWITCH button, KNOB 1 button, and KNOB 2 button. Each time you press the button, the functions being controlled are switched, and the SELECT LED is lit.

The functions controlled by the SELECT button are saved for each program, combination, or song.

#### SWITCH button, SWITCH LED

Each time you press this button, the function selected by the SELECT button turns on or off. If the function selected by the SELECT button is on, the SWITCH LED is brightly lit. The SWITCH LED is dimly lit for functions that are not selected by the SELECT button, letting you see the on/off status of those functions. The TAP LED blinks according to the tempo setting.

When you operate the button, the parameter name and value of the selected function appears in the display for a time.

**Tips:** If you long-press the SELECT button, a list of the selected functions appears. After a time, you return to the previous page or window.

**Note:** Display indications return to the previous page or window after a certain time has passed.

#### KNOB1 knob, KNOB2 knob

Turn these knobs to edit the functions selected by the SELECT button. If you edit a setting and then use the SELECT button to select another function, the state or value edited by the KNOB 1 and 2 knobs is preserved. However, be aware that if you re-select

the program etc., the program-related knob values are reset to the center position.

**Tips:** When you operate a knob, the function and value that you operated are shown. After a time, you return to the previous page or window.

**Note:** Display indications return to the previous page or window after a certain time has passed.

---

## 7. Modes

Press one of these buttons to enter the corresponding mode. The KROSS has four operating modes. The currently selected mode button will be lit up. (see "Selecting modes" on page 12)

#### PROG button



This button selects Program mode. Programs are basic sounds; in Program mode you can play and edit programs.

#### COMBI button

This button selects Combination mode. Combinations are sets of programs with split or layer settings; you can use a combination to create sounds that are more complex than a program. In Combination mode you can play and edit combinations.

#### SEQ button ( )

This button selects Sequencer mode. In this mode you can record, play, and edit MIDI songs.

By pressing the EXIT button (  ) and the SEQ button (  ), selects Global/Media mode. In this mode you can adjust overall settings for the KROSS, edit drum kits and arpeggio patterns, and save or load data using an SD card.

---

## 8. CATEGORY dial, LED

Use this dial to select the sound category of the program or combination.

---

## 9. Quick layer/split

Here you can easily create layered or split sounds using two programs.

Select the first sound in Program mode; then press this button. In the dialog box that appears, select the second sound and specify its volume; then confirm the settings.

Choose LAYER if you want the two sounds to play together across the entire keyboard; choose SPLIT if you want the two sounds to play separately in the high and regions of the keyboard.

**Note:** A layer or split sound that you create can be saved as a combination.

**Tips:** If you want to adjust more sophisticated settings in order to obtain more complex sounds, use Combination mode.

#### LAYER/SPLIT button

When you press the LAYER/SPLIT button, the QUICK LAYER dialog box or the QUICK SPLIT dialog box appears.

In the QUICK LAYER dialog box, pressing the PAGE+ (▶ SPLIT) button opens the QUICK SPLIT dialog box. In the QUICK SPLIT dialog box, pressing the PAGE- (LAYER ◀) button opens the QUICK LAYER dialog box.

#### QUICK LAYER DIALOG

A program of the strings category is layered with the currently selected program. Select a program to layer, and adjust the volume and octave settings. By pressing the MENU (WRITE) button you can save the settings to a user combination bank. (see page 29)



## QUICK SPLIT DIALOG

The currently selected program is assigned to the high range and a program of the bass category is assigned to the low range. Select the split program, swap the high and low programs if desired, and adjust settings such as the split point, volume, and octave. By pressing the MENU (WRITE) button you can save the settings to a user combination bank. (see page 30)

## 10. AUDIO REC (Audio recorder)

Here is where you can control the audio recorder, which lets you record and play back your KROSS performance or signal from an external audio input. You can execute functions such as play, stop, or record, and adjust various settings for the recorder.



To control the audio recorder, use the AUDIO REC ► / || (play/pause) button and the four buttons below the AUDIO RECORDER SETUP window.

 In order to use the audio recorder, you'll need a SD card (separately sold).

### ► / || (play/pause) button ( )

This is a dedicated button that executes the recorder playback (or record) and pause functions. In any mode, this button lets you immediately play (or record) or pause. The state of the light and color of the button indicates the operating status of the recorder.

Unlit:	Stopped
Lit green:	Playing
Blinking green:	Playback is paused
Lit red:	Recording
Blinking red:	Recording is paused
Blinking orange:	Recording is paused (waiting for Auto input)

If you hold down the EXIT button (  ) and press the ► / || (play/pause) button (  ), the AUDIO RECORDER SETUP window appears.

## 11. Display

This shows the parameters and settings of the KROSS, as well as a variety of other information.

**Pages:** Each screen of parameters or information is called a "page." To edit or adjust the settings of the KROSS, you'll access the page that contains the desired parameter, and then change its value.

**Dialog box:** The screen that appears when you need to perform a command function, confirm a result, or recall a temporary function is called a "dialog box."

For more about various objects that you'll see in pages and dialog boxes, please see page 7.

### Adjusting the display contrast

To adjust the contrast of the display, hold down the EXIT button and turn the VALUE dial. You can also adjust the display contrast in the Global/Media mode PREF 1 page. (see page 117)

## 12. Functions / Page controller

You'll use these buttons to access pages in the display, and to select or execute functions that provide convenient commands in each page. The functions of the four buttons will change according to the page or dialog box that's currently shown.

### FUNCTION button

This button shows a function list containing convenient commands on each page.

### PAGE- button

### PAGE+ button

Use these two buttons to move between pages in order to select the page that you want to see. The page name or tab that's displayed on the upper part of the page indicates the currently shown page.

### MENU button

This button displays the page menu for each mode, allowing you to select a page.

### Operations while a dialog box is shown

While a dialog box is shown, the function of these four buttons will change so that you can perform tasks that are appropriate for that dialog box. The functions assigned to the buttons are shown in the bottom of the display.

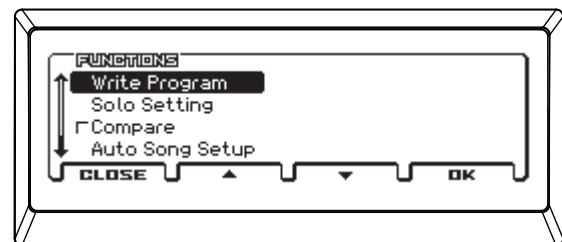

For example, suppose that you're in Program mode and press the FUNCTION button to access the function list.

The functions that are assigned to the four buttons are shown in the bottom of the dialog box.

If you press the CLOSE (actually FUNCTION) button, the dialog box will close and you'll return to the previous page.

Press the ▲ (actually PAGE-) button or ▼ (actually PAGE+) button to select a function.

Press the OK (actually MENU) button to open or execute the selected function.

For example if you select Write Program and press the MENU (OK) button, the WRITE PROGRAM dialog box will appear. Here, the FUNCTION (CANCEL) and MENU (OK) functions are assigned to the two buttons.

## 13. Value Controller

Use these to edit in the display. You'll use these to move the cursor and select parameters, to edit values, and also to execute or cancel commands.

### VALUE dial

Edit the value of the parameter (edit cell) where the cursor is located.

**Tips:** You can adjust the contrast of the display by holding down the EXIT button (  ) and turning the VALUE dial.

### EXIT button ( )

Use this button to cancel the execution of a function or the change in a parameter value, or to close a dialog box.

You'll also use this to move to the first page (such as the MAIN page) within the mode.

By using the EXIT button together with another button, you can perform the following functions.

Button or dial used with EXIT	Functions
SEQ button (  )	Selects Global/Media mode. If while in Global/Media mode you once again press the EXIT button (  ) and SEQ button (  ), you'll jump to the MEDIA >FILE page.
AUDIO REC  / (play/pause) button (  )	Opens the AUDIO RECORDER SETUP window.
SEQUENCER (REC) button (  )	In Sequencer mode, moves to the previously-specified playback start position. (see page 56)
STEP SEQ ACTIVE button (  )	Opens the STEP SEQ EDIT page.
FAVORITE ACTIVE button (  )	Enters the Add to Favorite registration-ready state.
SAMPLER ACTIVE button (  )	Opens the SAMPLER SETUP window.
SAMPLER HOLD button (  )	Puts the pad sampler in mute mode
AUDIO PLAY ACTIVE button (  )	Opens the AUDIO PLAY SETUP window.
VALUE dial	Adjusts the contrast. (see above)
REALTIME CONTROLS SELECT button	Selects the parameter to be controlled in reverse order.
BANK SELECT button	Selects favorites, pad sampler, and pad audio play banks in reverse order.

### ENTER button

Use this button to perform a function, select a radio button, or to turn a check box on/off.

When you select a parameter and press the ENTER button, you'll be able to use the ▲▼ cursor buttons to edit the value. After you've edited the value, press the ENTER button to confirm the change.

When you press the ENTER button on the MAIN page of Program or Combination mode, a sound select list will appear.

### ◀▶ ▲ ▼ Cursor buttons

Use these buttons to move the cursor in the display. Move the cursor up/down/left/right to select the parameter that you want to edit.

If the page contains more parameters than can be shown on a single screen, a ▲▼ symbol is shown to the left of the screen, and you'll be able to scroll the page up/down. (see "j: Scroll" on page 8)

You can also use the ▲▼ buttons to increment or decrement the value in steps of 1. (see "ENTER button and ▲▼ cursor buttons" on page 13)

## 14. SEQUENCER

You'll use these buttons in Sequencer mode to record and play back MIDI.

### ● (REC) button ( )

Pressing this button will enter record-ready mode. Once you're in record-ready mode (shown by the button's light), you can begin recording by pressing the SEQUENCER ▶ / ■ (start/stop) button. For details, please see "Recording MIDI in real time" on page 61.

By pressing this ● (REC) button in Program mode or Combination mode, you can instantly access the Auto Song Setup function which lets you start recording immediately. (see page 60)

Hold down the EXIT button ( ) and press the ● (REC) button ( ) to instantly move the song playback position to the specified location. By default, this will be the first beat of the first measure. You can also specify a desired location by using a function command.

### ▶ / ■ (start/stop) button

This button starts or stops recording and playback.

## 15. Pad section

### 1-16 Pad

Use pads 1-16 to control the step sequencer, favorites, sampler, and audio play.

You can switch the function of pads 1-16 by pressing the ACTIVE button ( ) that corresponds to each function, making it light. By pressing an ACTIVE button ( ) together with the EXIT button ( ), you can access the setup page for each function.

### STEP SEQ (Step Sequencer)

The **step sequencer** lets you easily create drum loop patterns by using pads 1–16 to turn the notes on/off that are played by the kick, snare, and hi-hat etc.

### ACTIVE button ( )

This button indicates and changes the on/off status of the step sequencer. If this is lit, you can use pads 1-16 to control the step sequencer. (see page 89)

When you hold down the EXIT button ( ) and press this button, the STEP SEQ EDIT page for Program, Combination, or Sequencer mode will appear, allowing you to turn steps on/off and to specify the pattern's resolution, length, and the sound used for each tone.

**Note:** If the favorites select screen is shown, holding down the EXIT button ( ) and pressing this button does not show the STEP SEQ EDIT page.

While the STEP SEQ EDIT page is shown, you can hold down the ACTIVE button and press pads 1-13 to select the tone (e.g., kick, snare, accent) that will be controlled by pads 1-16.

By holding down the ACTIVE button and pressing a key, you can select the sound (instrument) that's actually played by each tone. (see page 90)

### RUN button

When you press the RUN button (the button will be lit), the step sequencer will begin playing. You'll hear the drum loop pattern that's specified by pads 1–16.

When you press the RUN button once again (the button will be unlit), the step sequencer will stop playing.



### FAVORITES

The **Favorites function** lets you use pads 1–16 to instantly recall frequently-used programs, combinations, or audio songs for the audio recorder to play. You can use this function to register your favorite sounds, or to arrange the sounds you'll use during a live performance in the order that they will be needed.

**ACTIVE button (  )**

Use this button to turn the Favorites function on/off, or to register sounds. (see page 53)

To recall a sound that you've registered, turn this button on, and then use the BANK SELECT button and pads 1-16.

To register a sound, select that program or combination; then hold down the EXIT button (  ) and press the FAVORITES ACTIVE button (  ), and finally use the BANK SELECT button and pads 1-16.

**SAMPLER (Pad Sampler)**

The pad sampler function lets you use pads 1-16 to play or perform samples that you recorded from the performance of the KROSS or from an external audio input. You can also edit the samples. Up to four stereo samples can be played simultaneously. (see page 93)

**Note:** When using the pad sampler function, we recommend that you use an SD card. You can use the card to automatically save or load sample data.

**ACTIVE button (  )**

This button makes the pad sampler active, or displays the SETUP page when used with the EXIT button (  ). In the SAMPLER SETUP window, this lets you check and edit the assignments of samples to pads, prepare for sampling, and edit the recorded samples.

**HOLD button (  )**

By pressing this simultaneously with a pad, you can hold the pressed state of that pad. By using this with the EXIT button (  ), you can temporarily mute the currently-sounding pads.

**AUDIO PLAY (Pad Audio Play)****ACTIVE button (  )**

This button makes the pad audio play function active, or displays the SETUP page when used with the EXIT button (  ). In the AUDIO PLAY SETUP window, this lets you check and edit the assignments of audio songs to pads, import WAVE files, and adjust the volume.

**BANK SELECT****BANK SELECT button, BANK LED A-H**

Use this button to select the displayed zone of the step sequencer, or to switch banks of favorites, pad sampler, or pad audio play.

**Tips:** When selecting a bank, pressing the EXIT button (  ) and BANK SELECT button lets you select banks in reverse order. (Except for the step sequencer)

If the step sequencer is on (with the STEP SEQ button lit), pads 1-16 will show the on/off status of each step. You can use pads 1-16 to turn each step on/off.

A:Step1-16, B:Step17-32, C:Step33-48, D:Step49-64

If the Favorites function is on (FAVORITES button lit), this button selects the Favorites bank. Use pads 1-16 to select the following Favorites.

Bank A 1-16, bank B 1-16, bank C 1-16, bank D 1-16, bank E 1-16, bank F 1-16, bank G 1-16, bank H 1-16

When the pad sampler function is on (SAMPLER ACTIVE button lit), this selects sampler banks. You can use pads 1-16 to perform the following sample operations.

Bank A 1-16, bank B 1-16, bank C 1-16, bank D 1-16, bank E 1-16, bank F 1-16, bank G 1-16, bank H 1-16

When the pad audio play function is on (AUDIO PLAY ACTIVE button lit), you can select the audio play bank. You can use pads 1-16 to perform the following audio song operations.

Bank A 1-16, bank B 1-16, bank C 1-16, bank D 1-16, bank E 1-16, bank F 1-16, bank G 1-16, bank H 1-16

**16. Battery compartment**

The KROSS can be powered by batteries that you install here. (see page 19)

The battery compartment of the KROSS 61-key is located on the bottom panel.

**17. Compartment (KROSS 88-key only)**

The compartment can store small items such as a USB cable or AC adapter.

You can open the lid in the same way as you open the battery compartment cover. (→ p.19)

## Rear panel

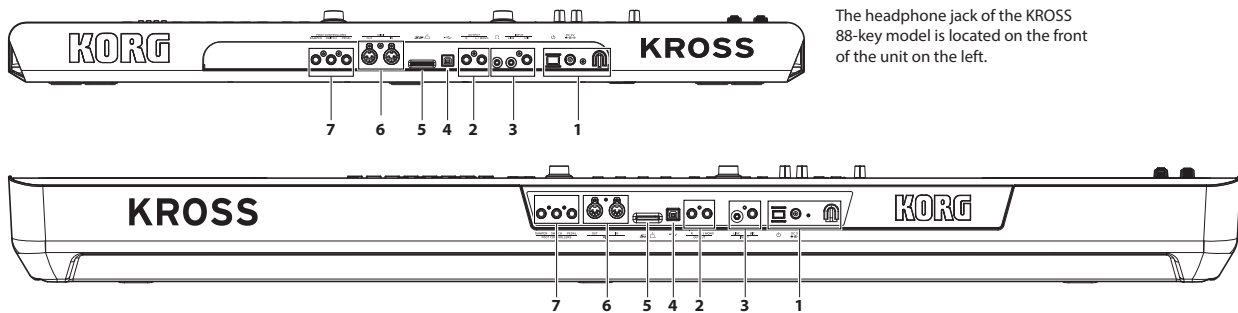

The headphone jack of the KROSS 88-key model is located on the front of the unit on the left.

### 1. Power supply

Be sure to see the “Turning the power on/off” section on page 17 and follow the correct procedure described there.

**Note:** The KROSS has an auto power-off function that automatically turns off the power when the keyboard or front panel buttons have not been used for a certain length of time. With the factory settings, this is set to 4 hours. (see “Auto power-off function” on page 18)

#### ⏻ (Power) button

To turn the power on or off, hold down the power button. (see page 17)

#### DC 9V jack

The included AC adapter is connected here. (see page 17)

⚠ Connections must be made with the power turned off. Please be aware that careless operation may damage your speaker system or cause malfunctions.

#### Cord hook

Use this to secure the cord of the included AC adapter. After connecting the AC adapter, loop the cord around the hook that’s located on rear panel so that the cord won’t get pulled out inadvertently. Leave enough slack on the plug end so that you can disconnect it if you want to. (see page 17)

⚠ Be careful not to bend the base of the plug any more than necessary.

### 2. Audio output

#### OUTPUT L/MONO, R jacks

These are stereo audio outputs. For stereo connections, use the L/MONO and R jacks. For mono connections, use the L/MONO jack. Use the VOLUME knob to adjust the volume. (see “Connecting your output devices” on page 21)

#### 🎧 (Headphone) jack

Connect the 1/8" stereo mini-phone plug of your headphones here. This jack outputs the same signal as the OUTPUT L/MONO and R jacks.

The headphone volume is controlled by the VOLUME knob.

**Note:** The headphone jack of the KROSS 88-key model is located on the front of the unit at the left.

### 3. Audio input

This jack lets you input audio from an external source; the audio can be recorded on the audio recorder or pad sampler, or sent through the internal effects and output via the OUTPUT jacks. To adjust the input gain (Gain) etc., use REALTIME CONTROLS - AUDIO IN 1 - KNOB1:GAIN. (You can also adjust these settings in the AUDIO IN page of each mode.)

⚠ The input gain (Gain) can be saved as a global setting (G-SET). (see “Global audio input settings (G-SET) and individual settings” on page 22)

**Note:** The input signals from the MIC IN jack and the LINE IN jack cannot be used simultaneously. To select the input that will be used, choose the REALTIME CONTROLS setting AUDIO IN 2 and use the SWITCH (MIC/LINE) button.

For more about connections and settings, please see “Connecting your input devices” on page 21.

#### MIC IN jack (1/4" phone type)

This is a 1/4" phone jack. You can connect a dynamic mic, an active-type guitar, or a guitar effect unit.

**Note:** This jack does not support condenser mics or other mics that require phantom power or plug-in power. Such types of mic must be connected via a mic preamp or appropriate device.

#### LINE IN jack (stereo mini type)

This is an 1/8" stereo mini phone jack. Connect it to the output jack of your audio device or external audio source.

### 4. USB

#### 🔌 port

#### (USB B type, for connecting to computer)

You can connect your computer to this port. Note data and other performance data, as well as sound settings, can be transmitted and received via MIDI between a computer and the KROSS; audio data can also be transmitted and received. (→ p.25)

## 5. SD card

### SD card slot

You can insert an SD card here. An SD card can be used to store KROSS sounds and song data. (see page 25)

 Since the SD card is accessed directly when you use the audio recorder to play or record, an SD card is required in order to use this functionality.

**Note:** When using the pad sampler function, we recommend that you use an SD card. You can use the card to automatically save or load sample data.

## 6. MIDI

### MIDI IN connector

### MIDI OUT connector

MIDI lets you connect the KROSS to a computer or other MIDI devices, for sending and receiving note data, controller gestures, sound settings, and so on. (see page 26)

## 7. Foot controllers

### DAMPER jack

An optional DS-1H (damper pedal) can be connected to this jack. If the optional DS-1H is connected, it will function as a half-damper pedal. If another switch-type pedal is connected, it will function as a damper switch.

The DS-1H half-damper pedal allows a finer degree of control compared to a switch-type pedal. Set the pedal polarity so that the pedal will function correctly. (see “Connecting a damper pedal” on page 23)

### ASSIGNABLE SWITCH jack

An on/off-type foot switch such as the optional PS-1 or PS-3 (pedal switch) can be connected to this jack. You can use a foot switch to apply modulation to sounds or effects, to set the tap tempo, or to start/stop the sequencer or to punch-in/out.

The function of the assignable switch is specified by Global/Media mode settings in the G-INPUT/CTRL> FOOT page, just as for the assignable pedal. (see “Connecting a foot switch” on page 23)

### ASSIGNABLE PEDAL jack

An optional EXP-2 (foot controller), XVP-10 or XVP-20 (expression pedal) can be connected to this jack. You can use a pedal to apply modulation to sounds or effects, or to adjust the overall volume.

The function of the assignable pedal is specified by Global/Media mode settings in the G-INPUT/CTRL> FOOT page. (see “Connecting a foot pedal” on page 24)

## 8. KORG Logo Light

The LED of the KORG logo will light. You can specify the color of the LED illumination, and whether it is lit or unlit. (→ PG p.159)

## Items in the display

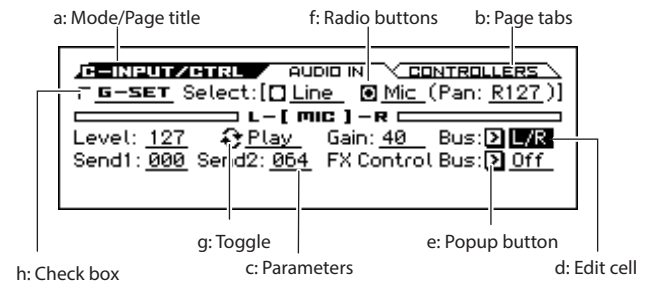

### a: Mode/Page title

This indicates the current page within the selected mode.

From the left, this shows the initial letter of the mode name and the page name.

### b: Page tabs

Most pages are divided into multiple tabs.

Use the PAGE+/- buttons to select the tab that you want to see.

### c: Parameters

The parameters for various settings are shown in the display.

Use the ◀▶▲▼ cursor buttons to select a parameter.

### d: Edit cell

Some of the parameters or parameter values will be highlighted when you use the ◀▶▲▼ cursor buttons. This is called the **edit cell**, and the highlighted item will be available for editing.

Other methods can also be used to adjust parameters that are indicated by the following icons.

### e: Popup button

If you use the cursor buttons to select a parameter indicated by this button (making it the edit cell) and press the ENTER button, a popup menu shows the available parameter values.

To enter a value for the parameter, use the ▲▼ cursor buttons.

### f: Radio buttons

If you use the cursor buttons to select a parameter with this type of button (i.e., making it the edit cell) and press the ENTER button, you then can choose one of multiple options.

You can also use the cursor buttons to select a parameter (making it the edit cell) and use the VALUE dial to select the value.

### g: Toggle

If a parameter with this symbol is selected (i.e., when it is the edit cell), pressing the ENTER button will switch the function or turn it on/off each time you press the ENTER button.

**h: Check box**

By selecting a check box parameter and pressing the ENTER button or turning the VALUE dial, you can select or clear the check box.

You can enable or disable a parameter or function by selecting or clearing the check box. The parameter or function is enabled if the check box is selected, and disabled if it is cleared.



**i: Category select icon**

For parameters indicated by this icon, you can use the CATEGORY dial or the VALUE dial to select the category or number.

**j: Scroll**

Use this to see parameter values that cannot be shown in a single screen. Additional parameters exist in the direction of the black indicator.

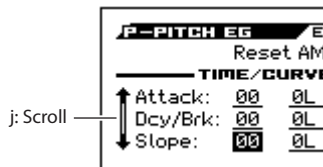

**k: Function list**

The function list will appear when you press the FUNCTION button. The functions that are shown will depend on the page that's selected.

The functions shown on the bottom of the dialog box are assigned to the four buttons. (see page 3)

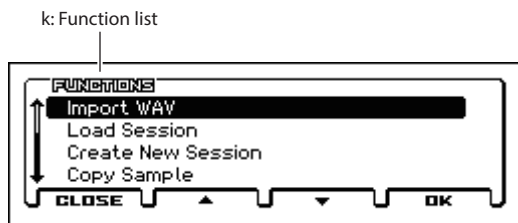

**l: Function dialog box**

When you select a function, you'll see a dialog box where you can adjust the settings that are needed to execute the command. The dialog box that appears will depend on the command that you selected. Some commands such as Solo Setting do not display a dialog box.

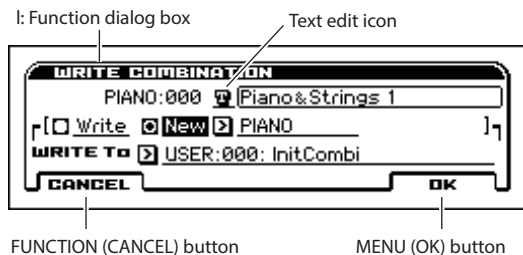

**\* Text edit**

When you select a parameter indicated by this icon and press the ENTER button, a text edit window will appear.

In this screen you can rename text (such as the name of a program, combination, or song). (see "Editing names" on page 124)

**\* MENU (OK) button, FUNCTION (CANCEL) button**

To execute a function, press the OK button. To cancel without executing, press the CANCEL button.

**\* DONE button, COPY button, INSERT button**

There are also buttons such as DONE, COPY, and INSERT which perform an action when pressed, like the OK button and CANCEL button explained in "\* Function dialog box."

# Basic Information

## About the KROSS's modes

### The KROSS has four modes

The KROSS has numerous functions that let you play and edit programs or combinations, record and play back sequence data, and manage media. These functions are grouped into “modes.” The KROSS has four modes.

#### Program mode

Programs are the basic sounds of KROSS.

In Program mode, you can:

- Select and play Programs.
- Use one arpeggiator in your performance.
- Play back Drum Track patterns while you perform using a Program.
- You can use the step sequencer to easily create drum loop patterns. You can play a program while a drum pattern plays back. You can also perform simultaneously with the arpeggiator and drum track.
- Edit Programs

You can use the Tone Adjust function to easily edit the program.

You can use the quick layer/split function to easily layer two programs or create split sounds.

You can adjust the parameters and settings of the oscillators, filters, amps, EGs, LFOs, effects, arpeggiator, drum track, etc.

You can use up to five insert effects, and two master effects.

Plus, you can create drum programs using drum kits (as created in Global/Media mode).

#### Combination mode

Combinations are sets of up to 16 programs that can be played simultaneously, letting you create sounds that are more complex than a single Program. In Combination mode, you can:

- Select and play Combinations.
- Use multiple timbres to play arpeggio patterns generated by two arpeggiators.
- Use one timbre for the drum track pattern, and play back a drum pattern while you perform.
- Use the step sequencer to easily create drum loop patterns. You can play a combination while a drum pattern plays back. You can also perform simultaneously with the arpeggiator and drum track.
- Use the KROSS as a 16-track multi-timbral tone generator.
- Edit Combinations

You can use the tone adjust function to easily edit the program of each timbre.

You can assign Programs to each of the 16 Timbres, each with separate volume, pan, and keyboard and velocity zones; adjust settings for effects, arpeggiator, drum track, step sequencer.

Plus, you can use up to five insert effects, and two master effects.

#### Sequencer mode

Sequencer mode lets you record, playback, and edit MIDI tracks. You can:

- Use the sixteen-track MIDI sequencer to record and play back songs.
- Record a single MIDI track, one at a time, or record as many as all sixteen tracks simultaneously. You can also record system exclusive messages.
- Record and play back the pad sampler performance.
- Use multiple tracks to record and play back performances generated by two arpeggiators.
- Use one track for the drum track pattern, and play back or record a drum pattern.
- Use the step sequencer to easily create drum patterns.
- Edit songs
- Use the KROSS as a 16-part multi-timbral sound module.
- GM/GM2 playback is also supported.
- Use the Tone Adjust function to easily edit the program of each track.
- Use up to five insert effects, and two master effects.

#### Global/Media mode

Here is where you can save/load data on an SD card. You can also adjust overall settings for the entire KROSS, and edit drum kits and arpeggio patterns.

You can:

- Adjust settings that affect the entire KROSS, such as master tune and global MIDI channel.
- Create user scales
- Create drum kits using drumsamples.
- Create user arpeggio patterns.
- Set the function of the assignable pedals and assignable buttons.
- Transmit MIDI System Exclusive data dumps.
- Save and load Programs, Combinations, MIDI Songs, and Global setup data.
- Format the SD card.
- Export and import sequences to and from SMF (Standard MIDI Files)

#### Other functions

In addition to its four modes, the KROSS provides various functions that are convenient for performance and practice: audio recorder, pad audio play, pad sampler, and favorites.

#### AUDIO RECORDER

There's an independent audio recorder that can record an audio signal from an external mic or line input, or USB audio input, or the audio of the program, combination, or sequencer playback. The sequencer and audio recorder are not able to synchronize. (see page 99)

#### PAD AUDIO PLAY

Using this function, audio songs that you recorded or audio files that were imported from an external source can be assigned to the pads and recalled easily for playback.

### **PAD SAMPLER**

Using this function, external input audio or phrases that you perform can be recorded and saved as sample data, and assigned to pads 1-16 for playback. Up to four samples can play back simultaneously, while you use pad operations to play samples as one-shot or as a loop. Control the data filer function (save and load MIDI exclusive data).

### **Favorites function**

You can register programs or combinations to pads 1-16 and recall them instantly regardless of the mode you're in.



Relational diagram of the KROSS's modes

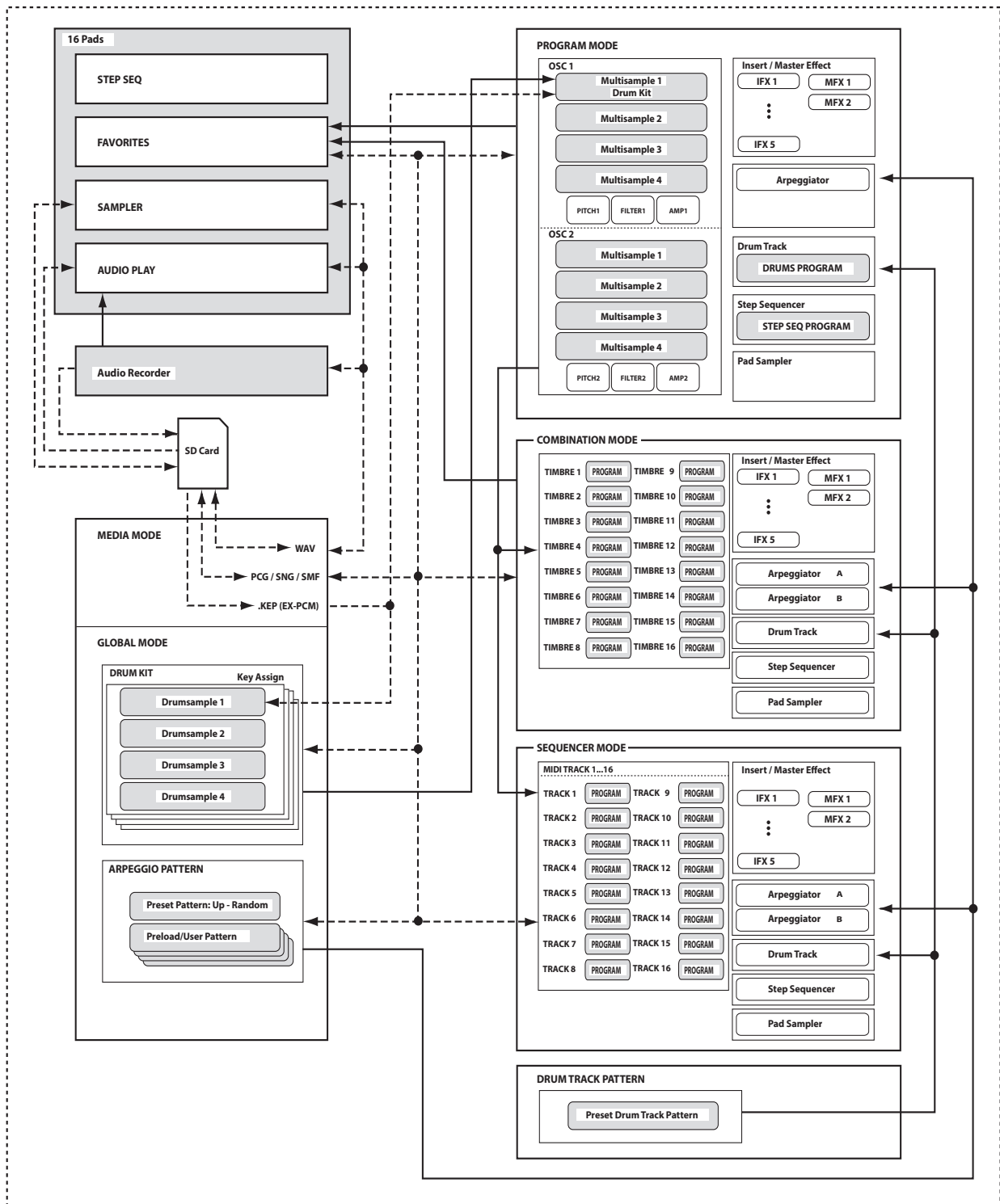



## Basic operations

After you've turned on the KROSS, here's how to perform basic operations, such as selecting modes and pages.

### Selecting modes

In order to use a particular function on the KROSS, you must first select the appropriate mode.

- Press one of the front panel mode buttons to enter the corresponding mode.

COMBI button:	Combination mode
PROG button:	Program mode
SEQ button(  ):	Sequencer mode
EXIT button (  )	Global/Media mode
+ SEQ button(  )	

For a summary of each mode, please see the "About the KROSS's modes" section on page 9.

**Note:** The mode that's currently selected is shown by the mode switch that's lit up.

### Selecting pages and tabs

One screen of displayed information is called a "page." To access the page you want, you can use the PAGE- and PAGE+ buttons, or you can press the MENU button and choose from the page menu.

- Make sure that the desired mode is selected.  
For this explanation we'll use Combination mode as an example.

#### Using the PAGE+/- buttons to move between pages

- You can move between pages by pressing the PAGE+ or PAGE- button.

#### Using the page menu to access different pages

The page menu shows a list of the pages and tabs within each mode. Select the desired page and tab from this list.

- Press the MENU button.

The page menu will appear.

The page where you were immediately before pressing the PAGE button is indicated by a diamond-shaped symbol to the left.

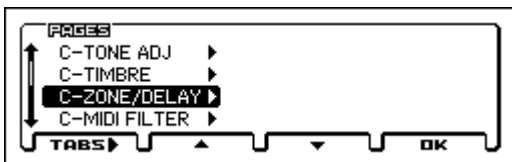

- Press the PAGE+ button or the PAGE- button to select a page.

As an example here, select C-ZONE/DELAY.

- Press the FUNCTION (TABS) button.

The "tabs of" (TABS OF) page will appear.

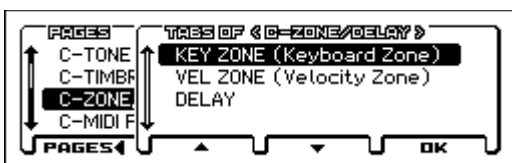

- Press the PAGE+ button or the PAGE- button to select a tab.

As an example here, select KEY ZONE.

- Press the MENU (OK) button.

The C-ZONE/DELAY> KEY ZONE page will appear.

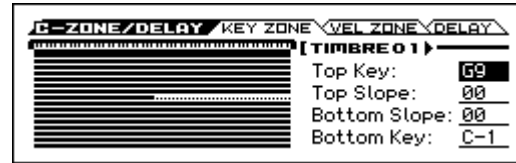

**Note:** If you select a page from the page menu (rather than from the "tabs of" menu), the page for the previously-selected tab will appear.

#### Using the MENU button + PAGE+/- buttons to move between pages

- Hold down the MENU button and press the PAGE+ (PAGE-) button.

In Combination mode, this lets you move in units of pages; e.g., COMBI ↔ C-INPUT/CTRL ↔ C-Tone ADJ ↔ C-TIMBRE ↔ ... etc. Each time, the page of the most recently selected tab will be selected.

#### Using the EXIT button to move between pages

- Pressing this button will take you back to the MAIN page of the current mode. Each time you press the button, you'll move between pages in the following way.  
Program, Combination, and Sequencer mode: the MAIN page of each mode.  
Global/Media mode: the BASIC page in Global/Media mode → the MAIN page in the previously-selected mode among program, combination and sequencer.
- When a dialog box is open, this button cancels the settings that were made in the dialog box and closes the dialog box, just like pressing the Cancel button.
- If a popup menu is open, pressing EXIT closes the menu.

### Selecting a parameter and editing the value

- Use the ◀▶▲▼ cursor buttons to select the parameter that you want to edit.
- If you select an edit cell, the display will be highlighted. Edit the value.

The way that the value will change depends on the type of parameter or object. (see "Items in the display" on page 7)

- The value in the edit cell can be edited by using the VALUE dial, the ENTER button, and the ▲▼ cursor buttons.

#### VALUE dial

Use this dial to edit the selected parameter's value. This control is convenient when you want to scroll through a very long list of selections.

## ENTER button and ▲ ▼ cursor buttons

When you select a parameter and press the ENTER button, a ▲ ▼ symbol will appear beside the value (000 → 000), and you can use the ▲ ▼ cursor buttons to increment or decrement the value in steps of one. When you've specified the value, press the ENTER button once again to confirm it. This method is convenient when you want to make small changes.

**Note:** If you decide not to change the value, press the EXIT button.

## Using the keyboard to enter a note number or velocity value

For parameters that specify a note number (such as G4 or C#2) or a velocity value, pressing the ENTER button will cause a ▲ ▼ symbol to appear beside the value (see above). You can play a key to directly enter a note number or velocity value. When you've specified the value, press the ENTER button once again to confirm it.

## ENTER button

If the parameter item is a toggle, radio button, or check box, press the ENTER button to switch the setting.

## Other

### CATEGORY dial, VALUE dial

Parameters indicated by  (category select icon) can be edited using the CATEGORY dial and VALUE dial to change the category and program/combination number. The dial's LED will light to indicate the current category.

In Program mode you can select the program category and number.

In Combination mode these dials have the following two functions.

- Select the combination category and number.
- When the edit cell is a timbre program (highlighted), the dials select the program category and number.

In Sequencer mode when the edit cell is a track program (highlighted), the dials select the program category and number.

## Compare/Undo function

### Program, Combination mode

Use this when you wish to compare the edits you have made to a program or combination's sound with the un-edited original (i.e., the sound that is written into memory).

While editing a program or combination, you can turn on the Compare function (select the check mark) to recall the settings that were last written to that program number or combination number. When you turn off the Compare function (remove the check mark), you will return to the settings that you had previously been editing.

#### 1. While editing, turn the Compare function on (select the check mark).

To turn this on, press the FUNCTION button to access the function list, use the PAGE+ (▼) or PAGE- (▲) button to select Compare, and press the MENU (OK) button.

The sound that had been saved before you began editing will be recalled.

#### 2. When you turn off the Compare function (remove the check mark), you will return to the sound that you had previously been editing.

To turn it off, select the Compare function once again and press the MENU (OK) button.

**Note:** If you edit the settings that were recalled by turning

Compare on (i.e., the saved settings), the check mark will be cleared, and your previously edited settings will be lost. Even if you turn Compare on again (select the check mark), the previous settings will not return.

## Sequencer mode

In Sequencer mode, you can use the Undo function to make "before and after" comparisons immediately after using realtime recording or step recording to record a song, or after performing an edit on a track.

For example, this can be used effectively when realtime-recording a MIDI track for a song.

1. **Realtime-record a MIDI track. (Take 1)**
2. **Once again, realtime-record on the same track. (Take 2)**
3. **If you turn on the Undo function (select the check mark), take 1 will be recalled.**
4. **If you turn off the Undo function (clear the check mark), take 2 will be recalled.**
5. **If at step 3 you once again realtime-record on the same track (take 3), the Compare function will now be referencing take 1.**
6. **If at step 4 you once again realtime-record on the same track (take 3), the Compare function will be referencing take 2.**

In this way, the Undo function lets you recall the previous recording or the previous state of event editing.

**Note:** If you edit while Undo is on (the check mark selected), the check mark will be cleared. That musical data now becomes the musical data that will be selected when Undo is off.

## Global/Media mode

The Compare function is not available in Global/Media mode.

## Audio recorder

When using the audio recorder, you can use Undo to return to a previously recorded state. You can step back through multiple takes. You can also redo. In the AUDIO RECORDER SETUP dialog box, press the PAGE- (UNDO) button.

## Pad Audio Play

As with the audio recorder, the pad audio play function also lets you return to the previously recorded state. In the AUDIO SONG SETUP dialog box, press the PAGE- (UNDO) button.

## Pad Sampler

The compare function cannot be used with pad sampler recording, nor when editing in the EDIT SAMPLE window.

## Selecting and executing functions

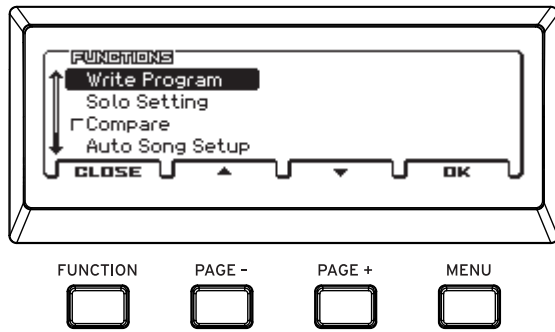

The functions provide commands that are specific to each page, such as Write (save) or Copy. The available functions will depend on the selected page.

For example, the functions in Program mode let you write (save) the settings, or let you perform convenient editing procedures such as copying settings between oscillators or effects, or a Sync function that lets you edit two EGs together.

### 1. Press the FUNCTION button.

The function list will appear.

### 2. Use the PAGE+ (▼) and PAGE- (▲) buttons to select a function, and press the MENU (OK) button.

A dialog box for the selected function will appear.

Check-type commands will not display a dialog box; their status will be switched, and the list will close.

- If you want to close the list without selecting a command, press the FUNCTION (CLOSE) button once again.

### 3. Use the ◀▶▲▼ cursor buttons to select parameters in the dialog box, and use the VALUE dial, ENTER button, and ▲▼ cursor buttons to enter the value.

You can use the CATEGORY dial and VALUE dial when selecting a program or combination number in the dialog box.

### 4. To execute, press the MENU (OK) button.

If you decide not to execute, press the FUNCTION (CANCEL) button.

The dialog box will close.

## Writing/saving

After editing, you should write or save your changes as necessary. For example if you've edited a program, your changes will be lost if you select another program or turn off the power. The same applies to a combination.

Settings that you edit in Global/Media mode, songs and Favorites will be remembered as long as the power is on, but your changes will be lost when you turn off the power, unless you write these changes into memory.

For more details on the Write procedure, see the following pages.

- Programs → p.122
- Combinations → p.122
- Favorites → p.54
- Global settings (GLOBAL-G-USER SCALE) → p.124
- Drum kits → p.124
- User arpeggio pattern → p.124
- User template songs → PG p.140
- For details on writing to internal memory → p.122

Please see the following pages for more information about saving.

- Saving a MIDI song → p.65
- Saving to SD card → p.121

**Note:** On the KROSS, the action of writing into internal memory is called "Writing," and the action of saving to an SD card device is called "Saving."

### Assigning a name (renaming)

You can edit the name of an edited program, combination, song, drum kit, or arpeggio pattern.

For additional details, please see "Editing names" on page 124.

## REALTIME CONTROLS

When you're playing a program or combination, you can use these to adjust the sound or the effects in real time, or to make simple edits. You can also adjust settings for external audio input and the vocoder function, and adjust the tempo of the arpeggiator and sequencer.

Here's how to use REALTIME CONTROLS to adjust the tempo.

### 1. Press the SELECT button several times to make the TEMPO light.

**Note:** The selection of the SELECT button is saved for each program, combination, or song.

**Tips:** By holding down the EXIT button ( **SHIFT** ) and pressing the SELECT button, you can step through the parameters in reverse order.

### 2. Turn the KNOB 1 knob to adjust the tempo.

### 3. You can set the tap tempo by pressing the SWITCH button. The tempo will be specified when you tap twice, but you should tap several times for better precision.

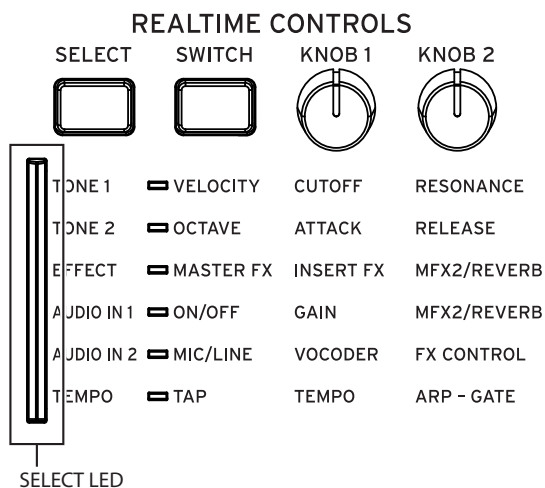

**Note:** REALTIME CONTROLS can be used when the SELECT LED is lit. They cannot be used when the LED is unlit.

## Parameters that can be operated using REALTIME CONTROLS

For details on each of the parameters that can be controlled, see the parameter guide. (→ PG p.305)

### TONE 1

- **VELOCITY**  
Specifies how the velocity of your keyboard playing affects the sound.
- **CUTOFF**  
Adjusts the cutoff frequency of the filter. Varies the brightness of the sound.
- **RESONANCE**  
Adjusts the resonance level of the filter. Raising the filter resonance level gives a distinctive character to the sound.

### TONE 2

- **OCTAVE**  
Raises or lowers the pitch of the entire keyboard in steps of an octave. With the default setting, the pitch is lowered one octave.

- **ATTACK**  
Adjusts the envelope attack times of the filter and amp. This specifies the attack time that starts at note-on.
- **RELEASE**  
Adjusts the envelope release times of the filter and amp. This specifies the time from note-off until the sound fades to silence.

### EFFECT

- **MASTER FX**  
Turns the master effect on/off.  
**Note:** This is linked with the setting of the Global/Media mode parameter System- "Effect SW - MFX."  
• **INSERT FX**  
Controls the "Wet/Dry" balance of all insert effects.
- **MFX2/REVERB**  
Controls the "Wet/Dry" balance of MFX2 (master effect 2).

### AUDIO IN 1

- **AUDIO ON/OFF**  
Selects whether an external audio source connected to the MIC IN or LINE IN jack will or will not be input.
- **GAIN**  
Adjusts the level at the input stage of the external audio signal that's being input.  
 So that the sound does not change suddenly while you're performing, the GAIN value does not change until the position of the knob matches the current value. Once you have turned the knob to the position of the current value, you can adjust the value.

- **MFX2/REVERB**  
Adjusts the send level at which the external audio signal that's being input is sent to master effect 2.  
For preload sounds, either a reverb-type or a delay-type effect is assigned to master effect 2. Use this when you want to apply these effects to the external audio from the mic input.

### AUDIO IN 2

- **MIC/LINE**  
Selects the external input jack that is used.
- **VOCODER**  
Selects a vocoder effect using the mic input, or an effect and program settings that are appropriate for vocals.  
In the VOCODER window, you can use the FUNCTION button to directly change or adjust settings such as AUDIO ON/OFF or GAIN for AUDIO IN 1.
- **FX CONTROL**  
Adjusts the tonal character of the vocoder or vocal effect that's selected by the VOCODER knob.

### Tempo

This adjusts the tempo for the entire KROSS. The tempo setting will control the following.

- \* Arpeggiator
- \* Drum Track
- \* Step sequencer
- \* Songs in Sequencer mode
- \* Tempo sync LFO
- \* Tempo sync (BPM) delay effects
- **TAP**

Sets the tempo via tap tempo. This LED will blink at quarter-note intervals of the current tempo.

▲ Tap tempo control is available whenever the KNOB1 knob (TEMPO) can be used. For example it cannot be controlled during song playback if the Sequencer mode Tempo Mode is set to Auto. (see page 103 of the Parameter Guide)

**Note:** You can use the tap tempo control function by pressing the SWITCH (TAP) button and also by pressing a foot switch that's connected to the ASSIGNABLE SWITCH jack. (page 23 and page 165, page 303 of the Parameter Guide)

- TEMPO  
Adjusts the tempo.
- ARP-GATE  
Changes the duration of the arpeggio notes in real time.

# Setup

## Turning the power on/off

The KROSS can be powered either by an AC adapter or by using batteries.

## Connecting the AC adapter

1. **Make sure that the power is turned off. Make sure that nothing is shown on the display, and that the LEDs are unlit.**
2. **Connect the DC plug of the included AC adapter to the DC9V (power supply) jack on the KROSS's rear panel.**
  - ⚠ You must only use the included AC adapter. Using any other AC adapter might cause malfunctions.
3. **Connect the AC adapter to an AC outlet.**
  - ⚠ Be sure to use an AC outlet of the correct voltage for your adapter.
4. **Use the cord hook of the KROSS to fasten the AC adapter cord so that it will not be unplugged accidentally.**

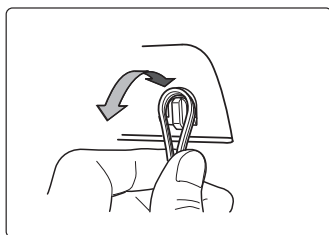
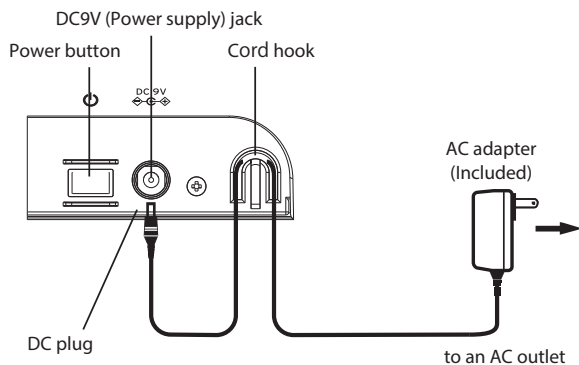

## Turning the power on

1. **Turn the KROSS's VOLUME knob all the way to the left so that the volume is down.**

If any external equipment, such as a monitor amplifier is connected, lower their volume as well and then turn off their power.

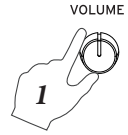

2. **On the rear panel of the KROSS, hold down the power button until the power turns on. Keep holding down the button until the display lights up.**

The display will show the model name and software version.



- ⚠ With the factory settings, the auto power-off function of the KROSS is enabled; immediately after you start up, the following message will appear, indicating the time until the power will turn off automatically.

If you disable the auto power-off function, this message is not displayed. (see "Auto power-off function" on page 18)

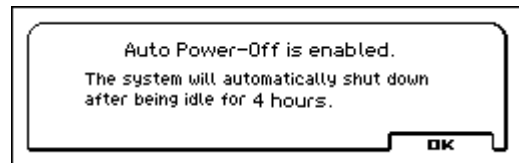

3. **Turn on the power of the external equipment that's connected to the KROSS's OUTPUT L/MONO and R jacks, such as a monitor amplifier.**
4. **Use the KROSS's VOLUME knob and the volume controls of your external equipment to set the volume to a suitable level.**

## Turning the power off

- ⚠ When you turn off the power, unsaved data will be lost. Be sure to save any important data such as edited sounds or global settings. (see page 14)
- ⚠ If the KROSS's auto power-off function is enabled, its power will automatically turn off if there has been no user input for a certain length of time. Unsaved data will be lost even if the power is turned off by the auto power-off function.

1. Turn the KROSS's VOLUME knob all the way to the left so that the volume is lowered.
2. If external equipment such as a monitor amplifier is connected, lower their volume and then turn off their power before proceeding.
3. Hold down the power button of the KROSS to turn off the power. Keep holding down the button until the display turns off.

- ⚠ Never turn off the power while processing is in progress. Turning off the power while the following processes are in progress may damage the data in internal memory or on the SD card.

- Writing data to internal memory (display indicates "Now writing into internal memory")
- Writing to an SD card (e.g., while saving in Media mode, recording on the audio recorder, or during Export)

- ⚠ A small amount of electrical power is used even when the power is off (STANDBY). If you won't be using the KROSS for an extended period, turn off the power and unplug the power cord from the AC outlet. If you're using batteries, remove the batteries.

## Auto power-off function

The KROSS has an auto power-off function that automatically turns off the power when there is no user input (\*) for a certain length of time. With the factory settings, this is set to four hours.

\* Using the VOLUME knob is not considered to be user input.

- ⚠ When the power turns off, the settings you had been editing will be lost. If you want to keep the edited settings, you must save them first.

## Changing the auto power-off setting

If you want to change the setting so that the power will not turn off automatically, proceed as follows to disable the auto power-off function.

1. Simultaneously press the EXIT button (SHIFT) and SEQ button (GLOBAL/MEDIA) to access the GLOBAL/MEDIA page. (If it does not appear, press the EXIT button.)

Auto power-off function

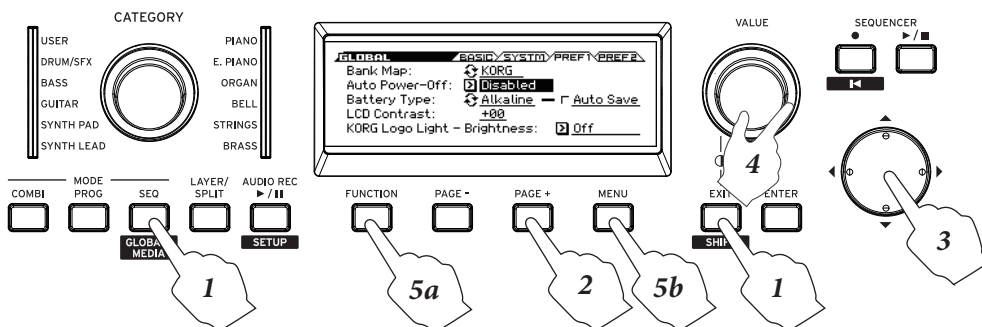

2. Press the PAGE+ (or PAGE-) button to access the GLOBAL> PREF 1(Preferences 1) page.
3. Use the cursor ▼▲ buttons to select the Auto Power-Off parameter.

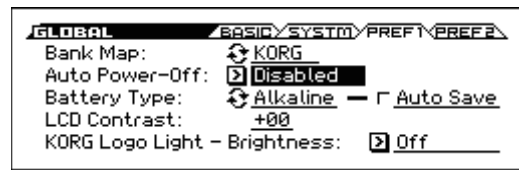

4. Use the VALUE dial to specify the time until the power will turn off.

If you don't want the auto power-off function to turn off the power automatically, set this to **Disabled**.

5. Save the setting.

Press the FUNCTION button to access the function list. Choose Write Global Setting. (If a different function is selected, press the PAGE- button to select it.)

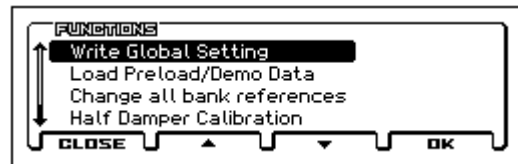

Press the MENU (OK) button. A confirmation message will appear; press the MENU (OK) button once again. The setting has now been saved.

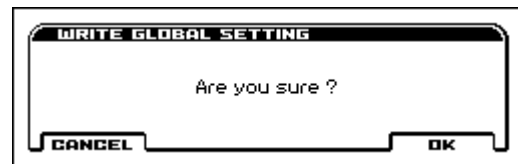

## Auto power-off warning message

When the specified length of time has elapsed without any user input on the KROSS, a message will appear, warning you that the auto power-off function is about to turn off the power.



If you want to continue using the system, press the keyboard, or a button. The Auto power-off function will be reset. If the same specified length of time elapses with no user input, the same message will appear again.



## Using batteries

### Batteries that can be used

Use six AA nickel-metal hydride batteries or alkaline batteries. Zinc-carbon batteries cannot be used.





**Note:** Batteries are not included. You'll need to obtain them separately.

- ⚠ Do not mix new and old batteries, or batteries of differing types. Mixing batteries in this way may cause them to leak or burst.

### Continuous operating time

Alkaline batteries will allow approximately four hours of usage with the factory settings. Battery life will depend on the type of batteries and the conditions of use.

### Replacing the batteries

An indicator on the upper right side of the screen shows the remaining battery capacity (  ,  ,  ). If you're using the AC adapter, this will indicate  .

- ⚠ If  is flashing, the batteries are almost exhausted. Immediately save any important data, and either install fresh batteries or switch to using the AC adapter.
- ⚠ If the batteries are exhausted, remove them immediately. Leaving exhausted batteries installed may cause malfunctions such as battery leakage. You should also remove the batteries if you won't be using the unit for an extended period of time.

**Note:** If the batteries run low, you can plug in the AC adapter and continue operation without having to power-off.

**Note:** If you turn on the power with an SD card already inserted, there will be some cases in which the data from the SD card is read as a background process after the unit has started. While the data is being read, some functions will be in a paused state, and will be unavailable. During this time, the SD card access indicator (  ) blinks in a position that overlaps with the remaining battery capacity indicator or the AC adapter indicator. For details, refer to "Automatic SD card loading at start-up" (→ p.25).

## Installing batteries

### 1. Remove the battery compartment cover.

**KROSS 61-key:** The battery compartment is located on the bottom panel.

- ⚠ When turning the unit upside down, place it on a blanket or similar material to prevent damage to the knobs and dials.

While pressing the cover latch, pull it upward and remove it.

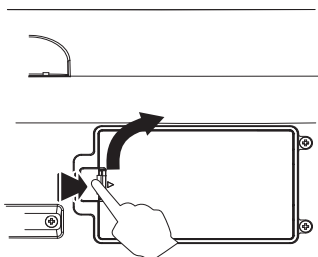

**KROSS 88-key:** While pressing the ||| area of the cover(a.), slide it diagonally upward (b.), and open the battery compartment (c.).

**Note:** The battery compartment cover is located on the left side of the front panel.

**Note:** You can use the same procedure to open the storage compartment for small items that is located at the opposite side from the battery compartment.

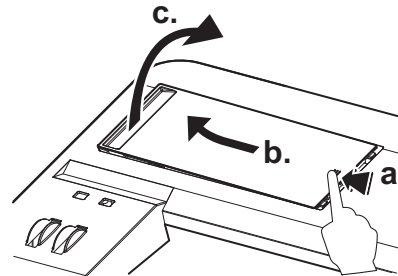

- ⚠ The battery compartment cover does not detach. Do not apply excessive force to the battery compartment cover.

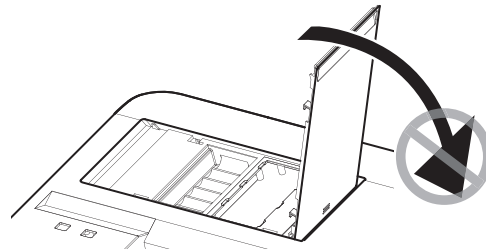

### 2. Install batteries.

- ⚠ When inserting the batteries, be sure to observe the correct polarity ("+" and "-"). Place the "-" end of each battery against the tip of the spring, and press it into place.

**KROSS 61-key**

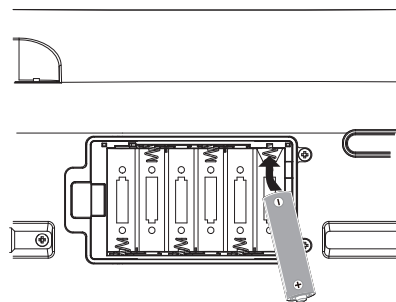

**KROSS 88-key**

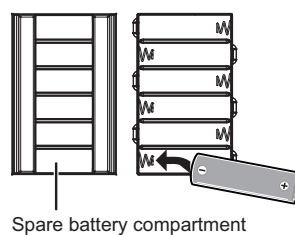

### 3. Close the battery compartment cover.

Close the cover by reversing the steps you took to remove it.

- ⚡ In order for the remaining battery amount to be displayed correctly, you must set the Global/Media mode GLOBAL>PREF 1(Preferences 1) page Battery Type setting to specify the type of battery that you're using.

## Specifying the type of batteries you installed

After you've installed the batteries, turn on the power and specify the type of batteries you're using.

- In the GLOBAL>PREF 1 (Preferences 1) page, select the Battery Type parameter.**

Perform steps 1–3 of “Changing the auto power-off setting” on page 18.

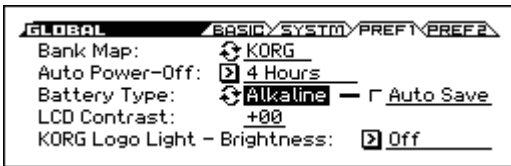

- Press the ENTER button to switch the setting.**

Alkaline batteries: Alkaline

Nickel-metal hydride batteries: Ni-MH

- Save the setting.**

Press the FUNCTION button, and in the function list choose Write Global Setting. (If a different function is selected, press the PAGE– button to select it.)

Press the MENU (OK) button. A confirmation message will appear; press the MENU (OK) button once again. The setting has now been saved.

# Connections

- Connections must be made with the power turned off.  
Please be aware that careless usage may damage your speaker system or cause other malfunctions.

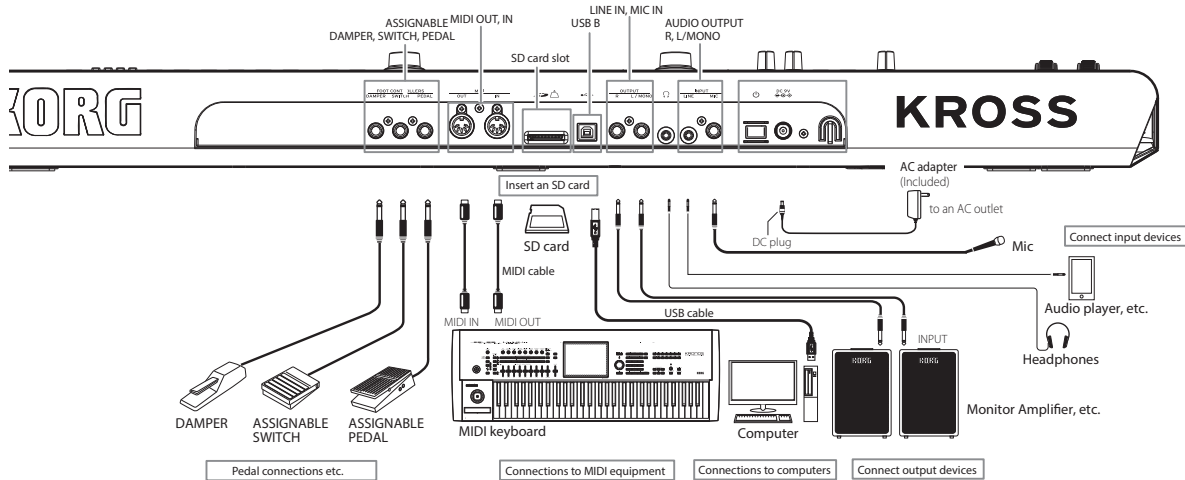

## Audio connections

### Connecting your output devices

The KROSS does not contain built-in speakers. In order to hear the sound of your performance, you'll need to connect other audio equipment such as a monitor amplifier, a mixer, a stereo set or headphones.

### Connecting audio equipment

- The KROSS's audio output is designed to produce a signal level that is higher than consumer audio equipment such as CD players. For this reason, performing at high a volume may damage your speakers or equipment. Please use caution when adjusting the volume.

1. Minimize the volume of all connected equipment, and turn off the power.
2. Connect the KROSS's OUTPUT L/MONO and R jacks to the input jacks of your monitor amplifier or mixer.

**Note:** If you connect only the L/MONO jack, the L and R sound will be mixed for mono output. In order to take full advantage of the KROSS's capabilities, we recommend that you listen in stereo.

If you're playing back through your stereo audio system or an audio player that has external input connectors, connect the KROSS to the jacks that are marked LINE IN, AUX IN, or external input. (You might need to obtain the appropriate adapter plug or conversion cable.)

### Connecting headphones

- Using headphones at high volume for an extended time may cause hearing damage. Please avoid excessively high volume levels.

1. Connect the stereo mini-plug of your headphones to the KROSS's Headphone jack.
2. Use the VOLUME knob to adjust the headphone volume.



The KROSS's Headphone jack will output the same signal as the OUTPUT L/MONO and R jacks.

The output from the OUTPUT jack is not turned off even if headphones are connected to the Headphone jack.

### Connecting your input devices

You can sing while applying the built-in effects of the KROSS to your mic, or connect an audio player and perform along with the playback.

You can also use the audio recorder or pad sampler to record the audio input. Alternatively, you can record just the external audio input without mixing-in the performance of the KROSS. For example if you're rehearsing in the studio, you could record only the band's performance while you play the KROSS. (→ p.22)

When connecting an input device, use the REALTIME CONTROLS section's SELECT button to select AUDIO IN 1, and press the SWITCH button (ON/OFF) to turn the input off (unlit). After you have connected the input device, once again press the SWITCH button (ON/OFF) to turn the input on (lit).

- If you're not using the MIC IN or LINE IN jack, use the REALTIME CONTROLS section's SELECT button to select AUDIO IN 1, and press the SWITCH button (ON/OFF) to turn the input off (unlit).

### Connecting a mic

1. Make sure that the SWITCH button LED (ON/OFF) is off (unlit) in the AUDIO IN 1 row of the REALTIME CONTROLS section.
2. Turn the VOLUME knob of the KROSS all the way to the left, minimizing the volume.

### 3. Connect a dynamic mic to the MIC IN jack.

*Note:* This jack does not support condenser mics or other mics that require phantom power or plug-in power. Such types of mic must be connected via a mic amp.

### Connecting a guitar

Connect your guitar to the MIC IN jack. Please see the “Connecting a mic” section above.

*Note:* Most guitars and basses (i.e., equipped with passive pickups that do not have a preamp) produce a low output level that cannot be recorded at a satisfactory volume or quality. Route such instruments through a preamp or effect unit before connecting them to the KROSS. If the output of the preamp or effect unit is too high, and you cannot set an appropriate input level, adjust the output level of the preamp or effect unit. If your instrument has active-type pickups with a built-in preamp, simply connect it directly.

### Connecting an audio player

An audio player or other stereo line input source can be connected to the LINE IN jack.

1. Make sure that the SWITCH button LED (ON/OFF) is off (unlit) in the AUDIO IN 1 row of the REALTIME CONTROLS section.
2. Turn the VOLUME knob of the KROSS all the way to the left, minimizing the volume.
3. Connect your audio player to the LINE IN jack.

### Selecting the audio input

Specify and enable the audio input to which you connected your mic, guitar, or audio player as described above.

*Note:* It's not possible to input audio via both the LINE IN jack and MIC IN jack simultaneously.

1. In REALTIME CONTROLS, use the SELECT button to select AUDIO IN 2.
2. In REALTIME CONTROL, use the SWITCH button to select either MIC (LED lit) or LINE (LED unlit). Only the selected input is enabled.

### Adjusting the audio input

1. Select the input. (“Selecting the audio input” on page 22)
2. Use the GAIN to adjust the level of the external audio signal. In REALTIME CONTROLS, use the SELECT button to select AUDIO IN 1, and use the KNOB 1 knob to adjust the volume of the input signal.

 So that the sound does not change suddenly while you're performing, the GAIN value does not change until the position of the knob matches the current value. Once you have turned the knob to the position of the current value, you can adjust the value.

3. If you want to change the amount of effect that is applied, adjust MFX2/REVERB in the AUDIO IN 1 row of the REALTIME CONTROLS section. Operating the KNOB 2 knob adjusts the amount that is sent to the MFX2 effect.

*Tip:* Although it will depend on the settings of the program or combination, Send2 typically applies reverb. For more about effect-related settings, see “Effect settings for audio input” on page 71.

4. To specify the pan, or the amount that is sent to the MFX1 effect, adjust settings in the AUDIO IN - QUICK SETTING- dialog box. If you press the

FUNCTION button while the popup screen is shown during steps 2 and 3, the AUDIO IN -QUICK SETTING- dialog box appears.



*Note:* The Global setting (G-SET) dialog box is shown above. These input settings are used by the entire KROSS. (see “Global audio input settings (G-SET) and individual settings”)

5. By setting the Direct Send parameter, you can record just the external audio input from a mic connected to the MIC IN jack, without recording the sound of the KROSS's performance. For example if you're rehearsing in the studio, you could record only the band's performance while you play the KROSS.



Direct Send

**Direct Send off:** The audio input and the KROSS's performance are mixed and recorded.

**Direct Send on:** Only the audio input is recorded. The sound of the KROSS's performance is not mixed. (In this case, the audio input sound is not output from audio out.)

6. To save the settings, press the PAGE+ (WRITE G-SET) button. A dialog box will appear; press the MENU (OK) button to save the settings.



*Note:* The explanation above is the procedure for saving Global settings (G-SET). (see “Global audio input settings (G-SET) and individual settings”)

7. Press the MENU (DONE) button to return to the page you were in prior to the dialog box.

### Global audio input settings (G-SET) and individual settings

The audio input of the KROSS is affected by settings that are shared by the entire instrument (Global settings / G-SET) and by individual settings that are made independently for each program, combination, or MIDI song.

With the factory settings, the programs, combinations, and MIDI songs are set to use G-SET by default. For some sounds, individual settings have been made for the vocoder sound or vocal effect. By opening the AUDIO IN -QUICK SETTING- dialog box, you can check whether that program or combination uses the global settings (G-SET) or its own individual settings.

*Tip:* Sounds with individual settings are stored in the DRUM/SFX category.



The AUDIO IN -QUICK SETTING- dialog box can be opened from the FUNCTION (QUICK SETTING) button shown in the lower left when you operate an audio-related parameter in REALTIME CONTROLS.

In the upper left, [G-SET], [PROG] (or [COMBI], [SEQ]) indicate whether the global settings (G-SET) or the individual settings are specified.

*Global setting (G-SET)*



*Individual setting (PROG, COMBI, SEQ)*



The global setting dialog box contains a PAGE+ (WRITE G-SET) button; by pressing this button you can save the edited settings as global settings. For individual settings, press the MENU (DONE) button to close the dialog box, and use the appropriate Write function to save the settings. For details on how to save, please see “Writing a Program or Combination” on page 122.

- Only in the case of input gain (Gain), the global setting (G-SET) and the individual setting are shared. Use the global setting (G-SET) to save the setting. Although you can edit this in the AUDIO IN page or the QUICK SETTING dialog box of each mode, you can't save it as an individual setting (PROG, COMBI, SEQ).

## To create individual settings

In addition to using the AUDIO IN -QUICK SETTING- dialog box, you can also adjust this setting in the INPUT/CTRL> AUDIO IN page of each mode. For a program, combination, or MIDI song that uses G-SET, the upper left of the screen will show the G-SET indication selected. By clearing this selection you can adjust individual settings.



## Connecting foot controllers

If you connect an optional damper pedal, foot switch, or foot pedal, you'll be able to control the KROSS using your feet.

### Connecting a damper pedal

When you press the damper pedal, the notes you've pressed will be sustained so that they will continue even after you take your hands off the keyboard. This is also called a sustain pedal; it has the same function as the damper pedal of an acoustic piano.

If the optional Korg DS-1H damper is connected, you'll be able to take advantage of the “half-damper” effect, where the depth that you press the pedal will vary the amount of damper that's applied. If any other type of pedal is connected, it will function as a damper switch.

In Combination or Sequencer mode, you can also select settings so that the damper will be applied to some sounds but not to other sounds.

1. Connect a Korg DS-1H damper pedal to the DAMPER jack.
2. Set the polarity of the switch.

In the G-INPUT/CTRL> FOOT page, set the Damper Polarity parameter.

If you're using the DS-1H, choose the (–) KORG Standard setting. With the factory settings, (–) KORG Standard is selected. If the operation is inverted when you use a foot switch other than the DS-1H, simply set the polarity to the (+) setting.

**Note:** The half-damper sensitivity is adjusted to a standard value when the KROSS is shipped from the factory. If the half-damper pedal you're using does not respond appropriately, please adjust the sensitivity. (see page 177 of the Parameter Guide)

### Connecting a foot switch

This lets you use a simple foot switch, such as the Korg PS-1 or PS-3, as an assignable controller. The foot switch can perform a wide variety of functions, such as:

- Selecting programs or favorites
- An assignable source for modulating sounds and effects
- Portamento on/off
- Sequencer start/stop or punch in/out
- Starting, pausing, and stopping audio recorder playback or recording
- Tap Tempo
- Arpeggiator on/off
- Switch the Drum Track on/off
- Step sequencer RUN on/off
- Use various KROSS controls (modulation wheel, SW1/SW2, etc.)

This button will always function in the same way regardless of the Program, Combination, or Song you've selected. You can assign the function in the Global/Media mode.

## Using a foot switch to select Programs

You can select programs by using a foot switch connected to the ASSIGNABLE SWITCH jack. By assigning the appropriate function, you can increment or decrement the program number in steps of one.

This lets you change Programs without using your hands—which is great for quick Program changes in live performance situations.

There are two ways of doing this: by assigning the foot switch to Program Up/Down, or to Value Inc/Dec. Each of these is suited to a particular application, as described below.

- Program Up/Down: When performing with the usual MAIN page or the favorites list open
- VALUE Inc/Dec: When performing with the sound select list open

### Assigning the foot switch to Program Up/Down

Assigning the foot switch to Program Up or Program Down lets you directly control Program changes from the foot switch. For most situations, this is the more straightforward method.

To set this up:

1. **Connect a foot switch to the rear-panel ASSIGNABLE SWITCH jack.**

Use an optional PS-1/PS-3 pedal switch.

2. **Access the G-INPUT/CTRL> FOOT page.**



Proceed as follows.

Hold down the EXIT button (SHIFT) and press the SEQ button (GLOBAL/MEDIA) to enter the GLOBAL/MEDIA mode.

Press the MENU button to access the function list. Use the PAGE+ (▼) and PAGE- (▲) buttons to select G-INPUT/CTRL, and press the MENU (OK) button.

Use the PAGE+ (▼) and PAGE- (▲) buttons to select the G-INPUT/CTRL> Foot page, and press the MENU (OK) button.

3. **Set “Foot Switch Assign” to either Program Up or Program Down.**

If you choose Program Up, the next program number up will be selected each time you press the foot switch.

If you choose Program Down, the next program number down will be selected each time you press the foot switch.

Use the cursor ▲▼ buttons to select Foot Switch Assign. Press the ENTER button to access the list, and use the cursor ▲▼ buttons to select Program Up or Program Down. Press the ENTER button to confirm your choice.

4. **Set the “Foot Switch Polarity” to match the polarity of the pedal you’ve connected.**

If you’ve connected the optional PS-1 or PS-3 pedal, choose (-) KORG Standard. Use the cursor ▼ button to select the parameter, and press the ENTER button. The setting will alternate on/off each time you press the button.

Now, the foot switch will step through the Programs, one by one.

5. **If you want to preserve this setting even when the power is turned off, be sure to Write the data. (see page 124)**
6. **Press the PROG button to enter PROG> MAIN, and press the foot switch to change the Program.**

*Note:* This setting also works in the same way for selecting combinations or favorites.

*Note:* With the Program Up/Down method, you can’t switch programs while the sound select list is open. Use the method explained below in “Assigning the foot switch to Value Inc/Dec”.

### Assigning the foot switch to Value Inc/Dec

This lets you use the Assignable Foot Switch to duplicate the functions of the VALUE dial.

This method is convenient if you want to open the Sound select list and switch programs while viewing the program or combination menu.

1. **Follow steps 1–2 under “Assigning the foot switch to Program Up/Down,” above.**
2. **At the top of the page, set the Foot Switch Assign parameter to Value Inc (or Value Dec).**
3. **Now, the foot switch will act just like you’re turning the VALUE dial.**

*Note:* The foot switch will work like this for the entire KROSS—not just when the Sound select list is open.

## Connecting a foot pedal

If you connect an optional EXP-2 foot controller or XVP-10/XVP-20 expression/volume pedal to the ASSIGNABLE PEDAL jack, you can use it to apply modulation to sounds or effects, or to adjust the overall volume.

This pedal will always function in the same way regardless of the Program, Combination, or Song you’ve selected. You can assign the function in the Global/Media mode.

Like the Assignable Foot Switch, described above, the Foot Pedal can be used for many different functions, including:

- Master Volume
- Channel Volume, Pan, or Expression
- Assignable sound modulation, as several different AMS or Dmod sources
- Effects Send level control
- Use various KROSS controls (Modulation wheel, etc.)

1. **Connect an optional XVP-10, XVP-20 or EXP-2 to the ASSIGNABLE PEDAL jacks.**
2. **Use the Foot Pedal Assign parameter (G-INPUT/CTRL> FOOT page) to specify the function that will be controlled by the foot pedal.**

Adjust settings as explained in “Assigning the foot switch to Program Up/Down”.

## Using an SD card

You can use an SD card to save or load programs, combinations, and song data, and also for audio recording and the pad sampler function.

### Types of SD card you can use

#### SD card specifications

SD memory cards up to 2GB and SDHC memory cards up to 32GB are supported.

SDXC memory cards are not supported.

MS-DOS format FAT16 or FAT32 are supported.

- ⚠ SD card is not included. You will need to purchase it separately.

#### Formatting SD card

Some consumer electronics products that use SD cards utilize their own proprietary format method. Before using an SD card with the KROSS, you must format it on the KROSS. (see page 129)

### Inserting/removing an SD card

#### Inserting an SD card

- Insert an SD card in the SD card slot.

With the card label facing upward, insert the connector end of the card into the SD card slot and press it in until you hear a click.

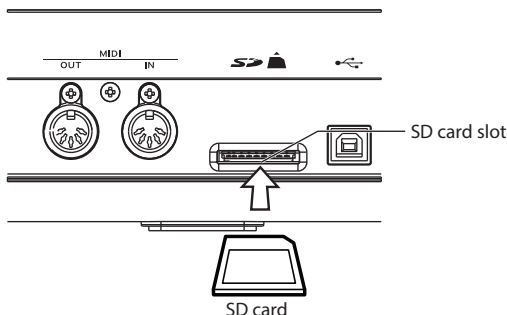

- ⚠ Make sure that the card is oriented correctly when you insert it. Forcing it in the wrong direction may damage the slot or the card, and the data may be lost.

#### Removing an SD card

- ⚠ During loading, saving, formatting, audio recorder operation, or MIDI data dump reception, you must never remove the SD card from the slot or insert it in the slot. Doing so may cause the SD card or the internal data to be damaged.

- Press the card inward; you will hear a click, and the card will partially pop out, allowing you to pull it completely out. Please see the owner's manual included with your card, and observe the guidelines for handling and use.

#### About the write protect setting of an SD card

SD cards have a write protect switch that prevents the data from being overwritten accidentally and lost. If a card is protected, you can't save or delete data on it, use it to record with the audio recorder, or format the card.

If you need to perform these procedures, you must first set the switch to its original position.

#### Automatic SD card loading at start-up

If the unit is powered-on with an SD card containing audio data already inserted, data loading may continue automatically after start-up in some cases. During this time, there are no restrictions on playing the keyboard or performing most operations, but functions that access the SD card will be in a paused state. The SD card access indicator (  ) will blink in a position that overlaps with the remaining battery capacity indicator or the AC adapter indicator.

At this time, the AUDIO REC, SAMPLER ACTIVE/HOLD, and AUDIO PLAY ACTIVE buttons will be disabled; if you press these buttons, the message "SD card busy Please wait." is displayed. Likewise, the "SD card busy Please wait." message is displayed if you access the MEDIA page, and that page will be unavailable.

Similarly, GLOBAL - FUNCTION - "Load Preload/Demo Data" and "Update System Software" will also be unavailable. To use these functions, wait until the SD card access indicator has stopped blinking.

## Connecting the KROSS to a computer

### USB connection

The KROSS provides both MIDI connectors and USB port as standard equipment. By connecting the KROSS to your computer via USB, you can use it as a controller and MIDI sound module for your DAW software with single cable convenience; and with out the need for a MIDI interface.

By using the dedicated editor, you can edit some of the parameters of the KROSS from your computer as though it were a software plug-in.

- ⚠ Before you connect the KROSS to your computer via USB, you must install the KORG USB-MIDI driver on your computer.

#### About the software

The latest version of the KORG USB-MIDI driver and the KROSS Editor/Plug-in Editor can be downloaded from the Korg website. (<http://www.korg.com/>)

Make connections as follows.

1. **From the Korg website, download the KORG USB-MIDI driver.**
2. **Install the driver as described in the documents that accompany it.**

*Note:* For audio, the KROSS uses the standard USB audio driver that is built into Windows or Mac OS, so you don't need to install the audio driver separately.

3. **Power-on the KROSS.**
4. **Connect the KROSS's USB B port to a USB port of your computer.**

When the KROSS is connected to the computer, the computer detects the KROSS as a USB MIDI device and a USB audio device.

## Connecting via the MIDI connectors

You can connect the KROSS to your computer via MIDI by using a commercially available MIDI interface.

**Note:** For more about MIDI interfaces, please see the owner's manual of the MIDI interface that you're using.

- ⚠ Some USB-MIDI interfaces may be unable to transmit or receive the KROSS's MIDI exclusive messages.

## Connecting MIDI devices

By connecting the KROSS's MIDI connectors to an external MIDI device you can transfer sound settings and performance data such as note messages between your external MIDI device and the KROSS.

### About MIDI

**MIDI** stands for Musical Instrument Digital Interface, and is a world-wide standard for exchanging various types of musical data between electronic musical instruments and computers. When MIDI cables are used to connect two or more MIDI devices, performance data can be exchanged between the devices, even if they were made by different manufacturers.

## Controlling an external MIDI tone generator from KROSS

If you want to use the KROSS's keyboard, chord trigger switches and other controllers, sequencer, and arpeggiator to play or control an external MIDI sound module, use a MIDI cable to connect the KROSS's MIDI OUT connector to the MIDI IN connector of your external MIDI sound module.

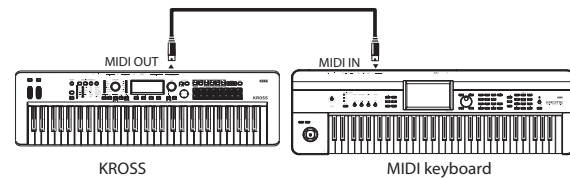

## Controlling KROSS's tone generator from an external MIDI device

When you wish to play or control the KROSS's tone generator from an external MIDI keyboard or sequencer etc., use a MIDI cable to connect the MIDI OUT connector of the external MIDI device to the MIDI IN connector of KROSS.

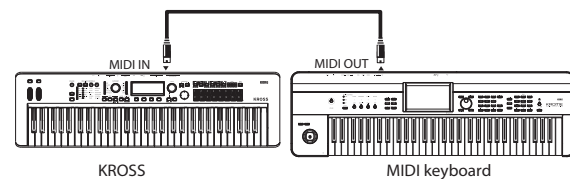

## Controlling two or more external MIDI tone generators from the KROSS

You can also use a MIDI patch bay to control multiple MIDI devices.

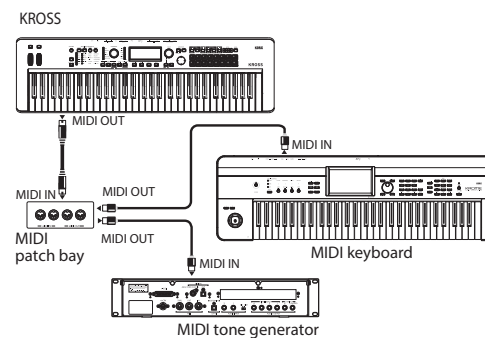



# Playing and editing Programs

## About the KROSS's Programs

Programs are the basic sounds of the KROSS; you can play and edit them in Program mode.

You can play them by themselves, layer them together in Combinations, or play a different Program on each of the 16 MIDI tracks, either from the internal sequencer or from external computer-based sequencers.

This section of the manual takes a quick look at playing Programs, including tours of the front-panel controllers and basic editing techniques.

## Playing Programs

### Selecting Programs

#### 1. Press the PROG button. (LED lit)

You'll enter Program mode.

Access the PROG> MAIN page. The upper line of the display shows the page that you're on. If a different page is shown, press the EXIT button several times to access the PROG MAIN page.

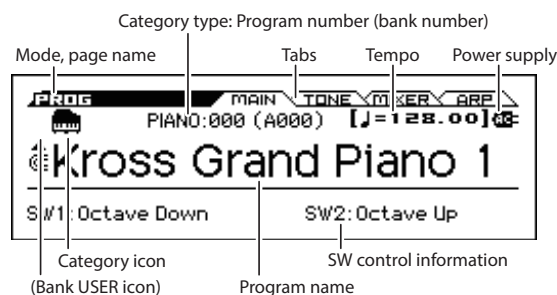

**Tip:** In the PROG> MAIN page, you can also select programs by using the cursor buttons ▲▼ or the VALUE dial.

#### 2. Turn the CATEGORY dial to select the category of program that you want to play.

The sound select list will appear.

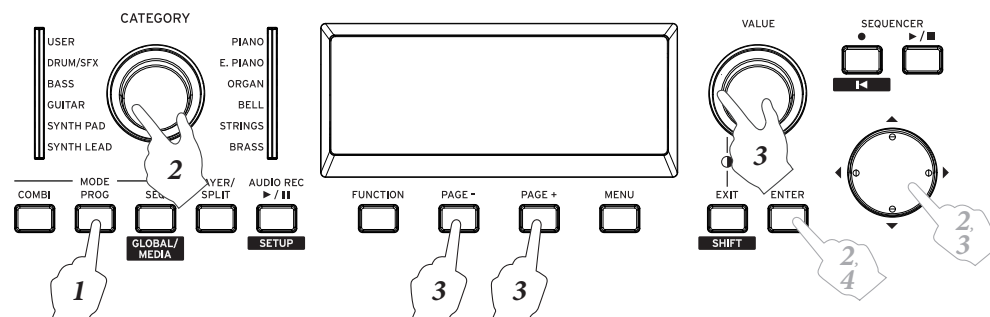
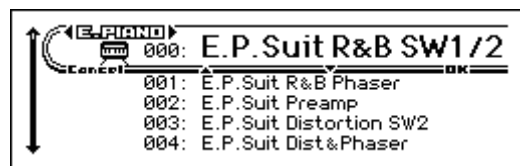

**Tip:** The sound select list will also appear when you press the ENTER button.

You can also use the cursor buttons ◀▶ to switch categories.

#### 3. Turn the VALUE dial to select the program that you want to play.

Play the keyboard to hear the sound.

**Tip:** You can also select programs by using the cursor buttons ▲▼ or the PAGE-(▲)PAGE+(▼) buttons.

#### 4. To return to the MAIN page, press the MENU button or the ENTER button to close the menu.

When you press the FUNCTION button or the EXIT button, your selection will be discarded and you'll return to the program where you were before opening the list.

### Other ways to select programs

In addition to using the controls on the KROSS's front panel, you can select programs in the following ways.

- Using a connected foot switch (see page 24)
- Receiving a MIDI program change (from an external MIDI sequencer or MIDI controller)
- Selecting a program that you've registered in Favorites (see page 53)
- Selecting a VOCODER or other program that's optimized for use with a mic input by the REALTIME CONTROLS. (see page 15)

## Program categories and numbers

The sounds of the KROSS are organized by type into categories; within each category, an index number is assigned to each sound. All programs are also assigned a bank and program number that are used to recall that program via MIDI.

**Note:** Depending on the bank, there are limitations on where a program can be saved. For details, please see “Bank numbers and conditions for saving” on page 121.

### Category and index number

Category	Index number (bank number)	Type of sounds
PIANO	000(A000)...063 (A063) 064 (G001)...073 (g2-001)	Acoustic piano
E.PIANO	000 (A064)...082 (B018) 045 (G005)...059 (g4-006)	E.P., clavi/harpsichord
ORGAN	000 (B019)...072 (B091) 073 (G017)...088 (g3-017)	Organ, accordion
BELL	000 (B092)...036 (C000) 037 (G010)...051 (g2-015)	Bell, mallet
STRINGS	000 (C001)...076 (B094) 077 (G041)...101 (g2-049)	Strings, vocal
BRASS	000 (B095)...058 (D008) 059 (G023)...091 (g2-058)	Brass, woodwind, reed
SYNTH LEAD	000 (D009)...093 (D102) 094 (G063)...112 (g3-082)	Lead synth
SYNTH PAD	000 (D103)...078 (E053) 079 (G089)...093 (g2-103)	Pad/motion synth
GUITAR	000 (E054)...043 (E097) 044 (G016)...079 (g3-029)	Acoustic/electric guitar
BASS	000 (E098)...062 (F032) 063 (G033)...079 (g4-039)	Electric/acoustic/synth bass
DRUM/SFX	000 (F033)...094 (F127) 095 (G048)...158 (gd-057)	Drums & percussion, hits, SFX, vocoder, etc.
USER	000...511 (UA000...UD127)	Sounds saved in the User category (With the factory settings, contains initialized programs)

### Index number

With the factory settings, the 768 preload programs of banks A–F, the 256 GM2 preset programs of the GM banks (GM–g(d)), and the 9 GM2 preset drum programs are organized into the PIANO–DRUM/SFX categories. Within each category, the programs are assigned an index number starting with 000.

The 512 initialized programs of bank UA000...UD127 are assigned to the USER category.

### Category

Program sounds are organized into the 12 categories listed in the table above. A program category icon is shown in the upper left of the display. The [USER] category icon is shown to the left of the PIANO–DRUM/SFX icon.

### Bank number

The bank number indication shows the number used for MIDI transmission and reception. Since the conditions for saving will differ depending on the bank, this provides a helpful guide. For more about banks, please see “Bank numbers and conditions for saving” on page 121.

For the programs in banks GM–g(d), a [GM] icon is shown at the left of the PIANO–DRUM/SFX icon mentioned earlier.

For details on programs, please see the separate “Voice Name List.”

## SW (Switch assignment) information

In the PROG> MAIN page you can see the following information above the selected program.

**SW1, SW2:** Indicate the functions that are assigned to the SW1 and SW2 buttons.

## Using Controllers

In addition to using the keyboard, the KROSS lets you control the sound by using the pitch bend wheel, modulation wheel, SW1 and SW2 buttons, damper pedal, and foot switch or foot pedal.

These controls let you modify the tone, pitch, volume, effects, etc. in realtime as you play.

- Pitch bend wheel, modulation wheel, SW1, SW2 buttons → p.1
- Damper pedal, foot switch/pedal → p.23
- REALTIME CONTROLS → p.15

## Performing with the arpeggiator, drum track or step sequencer

Based on the note data that it receives from the keyboard or from the MIDI IN connector, the arpeggiator can generate an arpeggio (broken chord), or produce a wide variety of phrases and patterns that are appropriate for the sound of the selected program, such as guitar or keyboard backing riffs, bass phrases, or drum patterns.

For more about the arpeggiator, please see page 73.

The Drum Track is a function that plays drum patterns in a variety of styles. For more about the Drum Track, please see page 83.

The step sequencer is a function that lets you create and play drum patterns in a way that’s similar to the Drum Track. While the Drum Track lets you select preset patterns, the step sequencer lets you create patterns from scratch. You can create and play drum patterns by turning on/off pads 1–16, which are located to the right side of the front panel. For more about the step sequencer, please see page 89.

The Drum Track and the step sequencer each produce sound using a drum program that is separate from the program that you play on the keyboard. You can play a program along with an accompaniment provided by the Drum Track and the step sequencer.

Arpeggiated phrases, the Drum Track, and the step sequencer pattern can all be synchronized, and you can also play along with them.

## Quick Layer/Split function

Quick Layer is a function that makes it easy to set up a layer, letting you play two sounds that are layered together. You can also adjust the volume balance.

Quick Split is a function that lets you create split settings so that you can play different sounds on the left and right regions of the keyboard. You can select each of the two programs, and adjust their volume and octave.

**Note:** The sound you create will be saved as a combination.

**Note:** This function makes layer or split settings that combine two program sounds. Since Combination mode lets you use up to 16 programs to create complex layers and splits, you can use Combination mode to make more detailed edits to the layer or split sound that you created here.

### Quick Layer

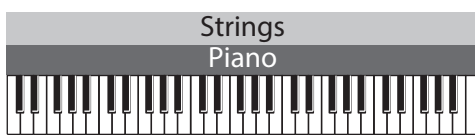

### Quick Split

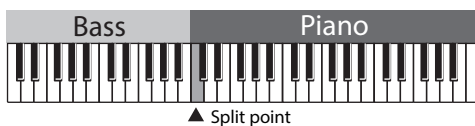

### LAYER/SPLIT button

The Quick Layer/Split function lets you adjust settings by pressing the front panel LAYER/SPLIT button.

**Note:** This function is available if Program mode is selected. It is not available in Combination mode.

**Note:** It is not available when selecting favorites.

## Quick Layer

A typical example of using layers is a sound that layers strings with piano or electric piano. As an example, here's how to create this sound.

1. Press the **PROG** button to select Program mode.
2. Select one of the two sounds (piano) that you want to layer.  
Turn the CATEGORY dial to select PIANO, and then turn the VALUE dial to select the piano program that you want to use.  
Press the MENU (OK) button or the ENTER button. (see "Selecting Programs" on page 27)
3. Press the **LAYER/SPLIT** button. (The button blinks.)
4. The **QUICK LAYER** dialog box or **QUICK SPLIT** dialog box appear. If the **QUICK SPLIT** dialog box appears, press the **PAGE-** (**LAYER** ◀) button to switch to the **QUICK LAYER** dialog box.

Play the keyboard, and you'll hear the layer sound.

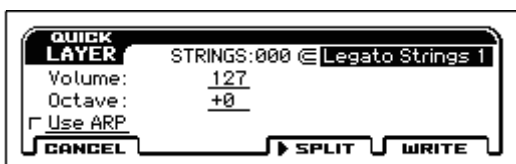

5. Select the other program (strings) that will be layered with the program you selected in step 2; then specify its volume and pitch.

- Program:

Select the program. If you used the CATEGORY dial and the VALUE dial, press the MENU button to close the list. (Default setting: category STRINGS, index number 000)

- Volume:

Adjust the volume (0–127) of the program you selected above for the Program to be layered. (Default setting 127)

- Octave:

Adjust the pitch of the program you selected above for the Program to be layered, in one-octave steps (-3, -2, -1, 0, +1, +2, +3). (Default setting 0)

- Use ARP:

This check box copies the arpeggiator settings of the program you selected above in the Program field. (Default setting: not selected)

**Note:** You can't change the settings of the first program (piano).

**Note:** The next time you open this dialog box, the last-specified settings will be selected as the default.

6. When you're finished, press the **MENU (WRITE)** button.

The save dialog box will appear.



7. Specify the combination name, the category, and the save-destination.

- Combination name:

If you want to edit the name, select the combination name and press the ENTER button. Enter a name in the text window. (see page 124)

By default, this will show the first 11 characters of the two program names joined. The two program names will be separated by "+" for Quick Layer, or by "\\" for Quick Split.

- Category:

Specify the combination category. By default, the category of the first program will be specified.

- WRITE To:

Specify the save-destination. You can only select the USER combination bank. By default, an ascending number starting at USER:000 will be selected.

8. Press the **MENU (OK)** button to save your combination.

The COMBI button will light up, you'll be in Combination mode, and the combination that you saved will be selected.

If you decide not to save the combination, press the **FUNCTION (CANCEL)** button. The dialog box will close, ending the procedure. You will return to the state of step 2, with that program selected.

Pressing the blinking **LAYER/SPLIT** button will also close the dialog box and end the procedure. You can press the **LAYER/SPLIT** button again to reproduce the settings of step 4.

## Quick Split

A typical example of a split is when you play a piano or electric piano with your right hand (in the upper region) and a bass sound with your left hand (in the lower region). As an example, here's how to create this sound.

### 1. In Program mode, select a piano program.

Please see steps 1–2 of the “Quick Layer” section on page 29.

**Note:** The procedure will be smoother if you first select the sound that you want to play in the upper region of the keyboard.

### 2. Press the LAYER/SPLIT button. (The button blinks.)

### 3. The QUICK LAYER dialog box or QUICK SPLIT dialog box appear. If the QUICK LAYER dialog box appears, press the PAGE+(► SPLIT) button to switch to the QUICK SPLIT dialog box.



### 4. Select the other program (bass) that will be split with the program you selected in step 1; then specify its volume and pitch.

#### • Program:

Select the other program. If you used the CATEGORY dial and the VALUE dial, press the MENU button to close the list.

(Default setting: category BASS, index number 000)

#### • Split Point:

Specify the point at which the two programs will be divided. When you play the keyboard, you'll hear the bass in the lower region and the piano in the upper region (including C4). (Default setting C4)

**Note:** You can use the keyboard to specify the split point. Select this parameter, and press the ENTER button so that the ▲▼ symbols are shown beside the value. Press a key on the keyboard to enter the note number. Press the ENTER button once again to confirm the setting.

#### • Lower/Upper:

If you select this parameter and press the ENTER button, the two sounds will be exchanged. (Default setting: Lower)

#### • Volume:

#### • Octave:

#### • Use ARP:

Please see step 4 of the “Quick Layer” section on page 29.

**Note:** You can't change the settings of the first program.

**Note:** The next time you open this dialog box, the last-specified settings will be selected as the default.

### 5. When you've finished adjusting settings, press the MENU (WRITE) button to open the dialog box, adjust the appropriate settings, and save them.

Please see steps 6 and 7 of “Quick Layer” on page 29.

## Combination settings made by Quick Layer/Split

When you use the Quick Layer or Quick Split function, the effects, Drum Track, and step sequencer will be assigned to the combination as follows.

### The program that had been selected prior to pressing the LAYER/SPLIT button

Program: copied to T01

Drum Track: copied to T10

Step sequencer: copied to T16

Arpeggiator: copied to Arp A

IFX1, IFX2, IFX5: copied to IFX1, IFX2, and IFX5

However, depending on the effect types and routing settings, some effects will not be copied.

MFX1, MFX2: copied to MFX1 and MFX2

### The program that was subsequently selected for layer/split

Program: copied to T02

Drum Track: not copied

Step sequencer: not copied

Arpeggiator: if Use ARP is selected, copied to Arp B

IFX1, IFX2: copied to IFX3 and IFX4

However, depending on the effect types and routing settings, some effects will not be copied.

MFX1, MFX2: not copied

## Easy program editing

### Using the Tone Adjust and EG Adjust functions

The fastest way to create the sound you need is to find a preload program that's close to what you want, and then modify its settings to your taste.

On the PROG> TONE page you can edit the sound's most important parameters, such as cutoff frequency, resonance, attack time, and release time.

#### 1. Access the PROG> TONE page.

Press the PROG button. Next, press the PAGE+ button or PAGE- button to access the PROG>TONE page.

#### 2. Use the cursor buttons ◀▶▲▼ to select the parameter that you want to edit.

#### 3. Use the VALUE dial etc. to edit the value.

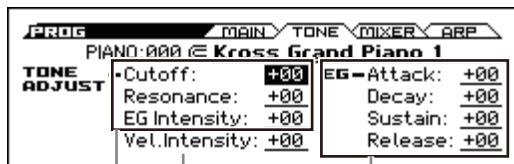

Tone Adjust (Filter):  
Brightness of the  
sound

Tone Adjust (Amp):  
Volume change  
produced by your  
keyboard dynamics

EG Adjust: Time-varying change  
in volume and brightness

### Tone Adjust controls

**Note:** When the Tone Adjust controls are at +00, the program parameters will have their original values.

#### Cutoff

This adjusts the filter's cutoff frequency. Adjusting the cutoff frequency will modify the brightness of the sound.

#### Resonance

This adjusts the filter's resonance level.

Adjusting the filter resonance level will boost the sound in the region of the frequency, giving a distinctive character to the sound.

#### In the case of a Low Pass Filter

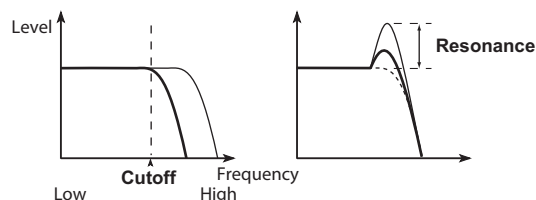

### EG Intensity

This adjusts the filter EG intensity (the depth of how the EG affects the filter). Normally, increasingly negative values ("−" settings) will make the filter EG have a shallower effect, and increasingly positive values ("+" settings) will make it have a deeper effect. Since the filter EG operates relative to the filter cutoff frequency, the tonal change produced by the filter will be affected both by Cutoff and by EG Intensity.

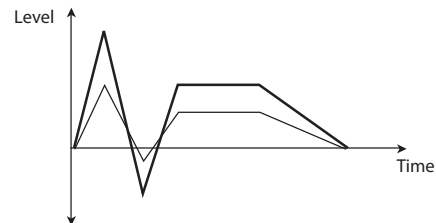

### Vel. Intensity

Adjusts the velocity intensity for the amp level.

With a setting of −99, velocity will no longer produce any change at all. A setting of +99 will produce maximum change in the same direction (positive or negative) as for the original program.

### EG Adjust controls

**Note:** With an adjustment of +00, the value of the program parameters will be unchanged.

#### Attack

Adjusts the EG attack times of the filter and amp simultaneously. This sets the time from note-on until the attack level is reached. Increasingly negative values ("−" settings) will shorten the attack time, and increasingly positive values ("+" settings) will lengthen it.

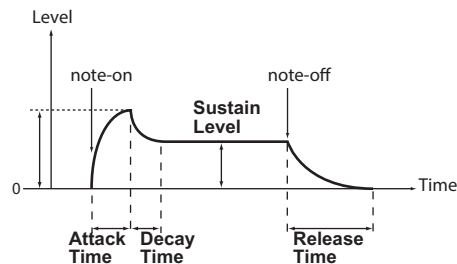

#### Decay

Adjusts the EG decay times of the filter and amp simultaneously. This sets the time from when the attack level is reached until the break level is reached. Increasingly negative values ("−" settings) will shorten the decay time, and increasingly positive values ("+" settings) will lengthen it.

#### Sustain

Adjusts the EG sustain level that follows the decay/slope time, for both the filter and amp simultaneously. This specifies the level that is reached after the decay time has elapsed, and is held until note-off. Increasingly negative values ("−" settings) will lower the sustain level, and increasingly positive values ("+" settings) will raise it.

#### Release

Adjusts the EG release times of the filter and amp simultaneously. This specifies the time from note-off until the sound disappears. Normally, negative settings will shorten the release time, and positive settings will lengthen it.

## Saving your edits

Internally, one controller modifies several parameters. Saving the program does not save the values of these controllers; it saves the edited state of the various parameters.

When the program has been written, the previously edited values will become the “new” reference values, meaning that the saved sound will be reproduced when these controllers are at +00.

## Adjusting the volume balance

The sound of a program consists of up to two “oscillators” that are played mainly from the keyboard, one “Drum Track” that automatically plays a rhythm section, and one “step sequencer.”

The volumes of the oscillators and the drum track can be adjusted in the PROG> MIXER page.

**Note:** There’s also a “mute function” which individually silences these, and a “solo function” which mutes all sounds other than the specified one.

### 1. Access the PROG> MIXER page.



### 2. Use the cursor buttons ◀▶▲▼ to select the “Vol” parameters of oscillator 1 or 2, the Drum Track, and the step sequencer, and adjust their volume.

**Note:** For single-oscillator programs, oscillator 2 will not be available for editing.

**Note:** If the **Hold Balance** function is selected, changing any of the volume values will simultaneously affect the other volume values as well. The overall volume balance will be preserved. This is convenient when you want to adjust the overall volume.

## Mute

- Select **Play/Mute** for oscillator 1 or 2, the Drum Track, or the step sequencer, and press the ENTER button to change the setting.

## Solo

- Select the Solo Setting function and press the MENU (OK) button to access the dialog box.

Use the cursor buttons ◀▶▲▼ to select the item that you want to solo, and press the ENTER button to turn solo on/off.

Pressing the PAGE- (CLEAR) button will turn off solo for all items.

If Exclusive Mode is on, only one item at a time will be soloed.

To return to the PROG> MIXER page, press the MENU (DONE) button.

## Using REALTIME CONTROLS to adjust the sound or effects

### REALTIME CONTROLS

SELECT	SWITCH	KNOB 1	KNOB 2
TONE 1	VELOCITY	CUTOFF	RESONANCE
TONE 2	OCTAVE	ATTACK	RELEASE
EFFECT	MASTER FX	INSERT FX	MFx2/REVERB
AUDIO IN 1	ON/OFF	GAIN	MFx2/REVERB
AUDIO IN 2	MIC/LINE	VOCODER	FX CONTROL
TEMPO	TAP	TEMPO	ARP - GATE

### 1. In program category "E.PIANO", select " 018 E.P.Suit Mark V"

This is an electric piano sound. Let's try modifying the character of the sound.

### 2. In REALTIME CONTROLS, press the SELECT button to select TONE 1. (LED lit)

### 3. While you play, slowly turn the KNOB 1 knob (CUTOFF) toward the right to about the 3/4 position.

The piano sound becomes more like a synth sweep.

### 4. Turn the KNOB 2 knob (RESONANCE) to about the 3/4 position as well.

### 5. Leave the KNOB 2 knob (RESONANCE) where it is, and try turning the KNOB 1 knob (CUTOFF) left and right.

Raising the resonance gives the sound a character as though it was being played through a wah pedal.

### 6. Next, in REALTIME CONTROLS, press the SELECT button to select TONE 2. (LED lit)

### 7. Try adjusting the KNOB 1 knob (ATTACK) or the KNOB 2 knob (RELEASE). These modify the attack time or the release time, changing the character of the sound.

### 8. If you want to save the sound that you edited, execute "Write Program" to save the edited sound.

Saving the edited content does not save the angle of the knobs; it saves the edited state of the various parameters.

When the data has been written, the previously edited values will become the "new" reference values, meaning that the saved sound will be reproduced when the knobs are at the center position. (see page 308 of the Parameter Guide)

## Comparing the unedited sound

### Using COMPARE

When you're in the process of editing a sound, pressing the COMPARE button will recall the last saved version of the sound, as it was before you started editing.

For details, please see “Compare/Undo function” on page 13.

---

## Saving your edits

After you've edited a program, you must save it if you want to keep the changes you've made. If you re-select the program or turn off the power after editing, your edits will be lost.

For details, please see "Writing a Program or Combination" on page 122.

You can also save programs on an SD card as .PCG files. For additional details, please see "Saving to SD card" on page 125.

## Detailed Editing with Programs

You can create original sounds by editing a preloaded program or by editing an initialized program.

For details, please see “Saving your edits” on page 33.

### Before you start editing

#### The three elements of sound: pitch, tone, and volume

Sound is made up of three basic elements: pitch, tone, and volume.

The KROSS provides “pitch,” “filter,” and “amp (amplifier)” sections that allow you to control these elements.

The “pitch” section modifies the pitch, the “filter” section modifies the tone, and the “amp” section modifies the volume.

Pitch settings are made in the P-PITCH and P-PITCH EG pages; filter settings are made in the P-FILTER and P-FILTER EG pages; amp settings are made in the P-AMP and P-AMP EG pages.

#### EG, LFO, AMS, and controllers

In addition to the three elements listed above, a sound can vary according to the passage of time, the pitch range in which it’s played, or by performance expressions.

Such aspects can be controlled by modulators and controllers such as the EG (envelope generator), LFO (low frequency oscillator), and the modulation wheel. These modulators and controllers can apply changes to the basic program.

Take a look at the illustration below called “Program structure.” Notice that the signal flow is in the order of Oscillator/Pitch, Filter, Amp. You can see how the EGs and LFOs affect each section.

As shown in the illustration, each program consists of sections such as OSC 1/2, effects, and the arpeggiator.

### OSC (oscillator) 1/2

The OSC (oscillator) generates the waveform that is the basis of the sound. On the KROSS, the oscillator consists of multiple sampled sounds, such as a multisample or a drum kit (drumsamples).

The KROSS provides two oscillators; OSC1 and OSC2. You can create more complex programs by combining these.

The OSC, which is the basis of the sound, can be controlled by modulating its pitch, filter, amp, EG, and LFO to change the sound in a wide range of ways.

*Note:* Pitch EG is shared by OSC1 and OSC2.

### Effects

As effects, you can use five insert effects, and two master effects.

The output of OSC 1/2 is sent to these effect processors. By choosing the desired effect for each processor and editing its parameters, you can apply a wide range of effects such as modulation, distortion, and reverberation.

### Arpeggiator

A program can use one arpeggiator. You can select an arpeggio pattern, specify the range that the pattern will be developed within, and specify the range of notes or velocities that will trigger the arpeggiator.

### Drum Track and step sequencer

While the arpeggiator plays the main program, separate drum programs are provided for the Drum Track and the step sequencer.

The Drum Track lets you select a drum program and pattern, and specify how it will be triggered.

The step sequencer lets you select the instrument that the drum program will use, and lets you specify a pattern by using pads 1–16.

Program structure

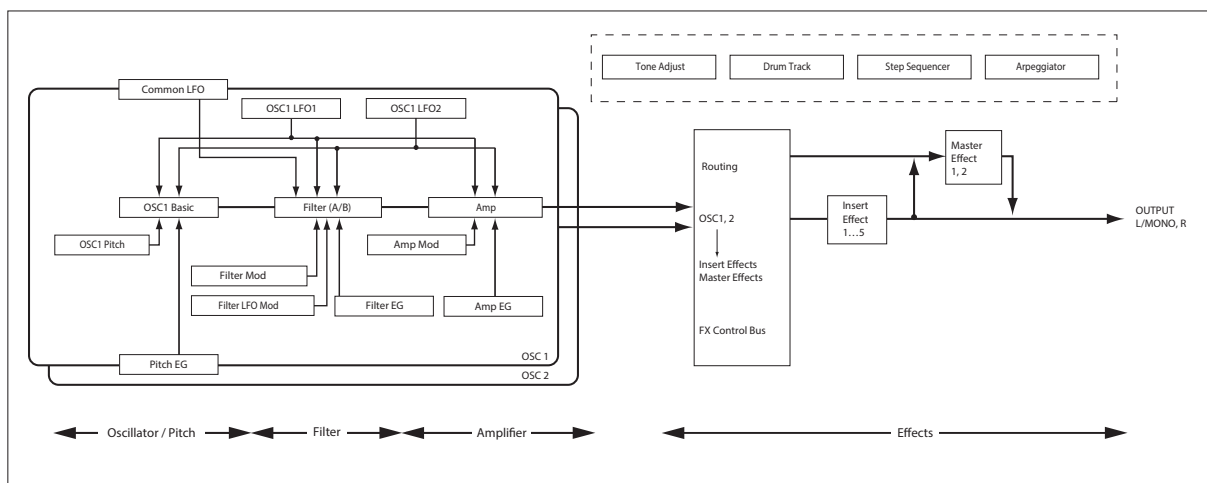



## An overview of the edit pages

In order to do detailed editing, you'll need to access the edit pages in the display.

The preceding section "Easy program editing" on page 31 explained how to use the PROG> TONE page to do simple editing. For more detailed editing, you'll use the P-BASIC and following edit pages.

Page	Tabs	Main content
PROG	MAIN	Select and play programs
	TONE	Easy sound editing
	MIXER	OSC1, 2, Drum Track, and step sequencer volume adjustment and mute settings
	ARP	Simple arpeggiator editing
P-INPUT/ CTRL	AUDIO IN	External audio input settings
	CONTROLLERS	SW1 and 2 function settings and tempo setting
P-BASIC	VOICE	Basic program settings, such as Oscillator mode
	NOTE-ON	Key zone, and timing settings following note-on
	SCALE	Scale settings
P-OSC	MS1...MS4	Multisample and drum kit settings
	VEL	Oscillator velocity zone settings
P-PITCH	BASIC	Oscillator 1 and 2 pitch settings
	MOD	Pitch modulation settings
	PORTA	Portamento settings
P-PITCH EG	ENVELOPE	Pitch EG settings
	L-MOD	Pitch EG level modulation settings
	T-MOD	Pitch EG time modulation settings
P-FILTER	BASIC	Oscillator 1 and 2 filter settings
	MOD	Filter modulation settings
	EG-I	Filter EG intensity settings
	LFO-I	Filter LFO intensity settings
	KTRK	Filter keyboard tracking settings
P-FILTER EG	ENVELOPE	Oscillator 1 and 2 filter EG settings
	L-MOD	Filter EG level modulation settings
	T-MOD	Filter EG time modulation settings
P-AMP	BASIC	Oscillator 1 and 2 amp (volume) and pan settings
	MOD	Amp modulation settings
	KEYTRK	Amp keyboard tracking settings
P-AMP EG	ENVELOPE	Oscillator 1 and 2 amp EG settings
	L-MOD	Amp EG level modulation settings
	T-MOD	Amp EG time modulation settings
P-OSC LFO	1. WAV	Oscillator 1 and 2 LFO1 waveform settings
	1. FRQ	LFO1 frequency and modulation settings
	2. WAV	Oscillator 1 and 2 LFO2 waveform settings
	2. FRQ	LFO2 frequency and modulation settings
P-CMN LFO/KT	LFO.W	Common LFO waveform settings
	LFO.F	Common LFO frequency and modulation settings
	KT.1	Common keyboard tracking 1 settings
	KT.2	Common keyboard tracking 2 settings
P-AMS MIXER	1	Oscillator 1 and 2 AMS mixer 1 settings
	2	Oscillator 1 and 2 AMS mixer 2 settings
P-ARP	SETUP	Arpeggiator settings
	SCAN ZONE	Specifies the range in which the arpeggiator operates

Page	Tabs	Main content
P-DRUM TRACK	PATTERN	Drum Track pattern selection and trigger region settings
	PROGRAM	Drum Track program selection
P-STEP SEQ	BASIC	Step sequencer program selection and length settings
	EDIT	Step on/off entry
	INST	Instrument settings
	MOD	Step sequencer effects such as accent and swing
	MIX	Drum program selection
P-FX ROUTING	BUS	Oscillator 1 and 2 insert effect bus settings
	SEND	Oscillator 1 and 2 master effect send level settings
	IFX	Insert effect type selection and chain settings
	MIXER	Post-insert effect routing settings
P-IFX	IFX1	Insert effect 1-5 settings
	IFX2	
	IFX3	
	IFX4	
	IFX5	
P-MFX	SETUP	Master effect type selection and chain settings
	MFX1	Master effect 1 and 2 settings
	MFX2	

For details on how to access each mode and page, please see "Basic operations" on page 12.

## Switching the screen between oscillator 1 and 2

To edit parameters such as the pitch, filter, or amp of oscillator 1 or oscillator 2, use the cursor buttons to select OSC on the upper left, and use the ENTER button or the VALUE dial to select the oscillator that you want to edit.

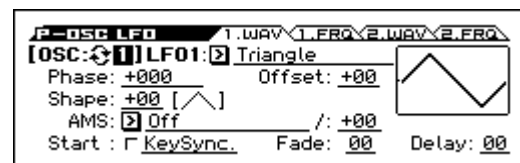

## Basic oscillator settings

Here is where you can specify the type of program, select the basic waveform (multisample or drum kit), and specify whether it will play polyphonically or monophonically (poly/mono).

### Program type setting (single, double, drum kit)

Here is where you can specify the program type.

Broadly speaking, the program type will be either “a program that uses a multisample” or “a program that uses a drum kit.” (see “Multisamples and Drum Kits,” below)

This choice is made by the PROG> VOICE “OSC Oscillator Mode” setting, which specifies which type the oscillators will use.

- Multisample: Single, Double
- Drum kit: Drums

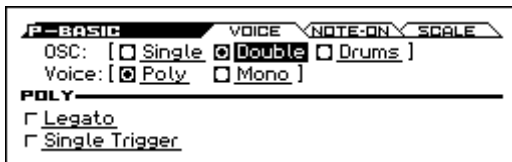

**Single** (single program) uses one oscillator, and **Double** (double program) uses two oscillators.

**Drums** (drum program) is similar to a single program, but uses a drum kit (created in Global/Media mode) instead of a multisample.

### Polyphony

Polyphony is the number of notes that can be played simultaneously, such as in a chord. The polyphony depends on the program type.

Program type	Polyphony
Single	80
Double	40
Drums	80

**Note:**

- Double Programs use twice as many voices as Single Programs.
- Stereo Multisamples use twice as many voices as Mono Multisamples.
- If using velocity crossfade switching, the multisample will use twice as many voices as usual.

## Polyphonic/monophonic playing

To specify whether the program will play polyphonically (Poly) or monophonically (Mono), access the PROG> VOICE page and set the Voice parameter.

When this is set to **Poly**, you can play both chords and melody lines. When this is set to **Mono**, only one note will sound even if you play a chord.

Normally you’ll set this to **Poly**, but **Mono** is useful when playing sounds such as synth basses, synth leads, and other solo instruments.

Try switching between Poly and Mono, and listen to the results.

## Working with Multisamples

### What is a multisample?

A multisample is a collection of similarly voiced samples, used to create the same type of sound - piano, bass, guitar, strings, organ - across the entire keyboard, as the basis of a program.

For each oscillator, you can assign up to four multisamples and switch between them by velocity.

### Multisamples and Drum Kits

Multisamples and Drum Kits allow you to play samples in different ways.

- Multisamples lay out one or more samples across the keyboard. If we use the example of a simple guitar multisample, one sample could be assigned for each string, so that the multisample would consist of six samples.
- As the name suggests, Drum Kits are optimized for playing drumsamples.

### Velocity switch, crossfades, and layers

Each oscillator provides four velocity zones. This lets you switch between multisamples or drumsamples according to the velocity (speed) at which you play a key.

By specifying the threshold (boundary value) where each zone will respond, and the amount of crossfading (the overlap between zones), you can specify how your keyboard playing dynamics will switch or layer the multisamples or drumsamples. You can use this to make the following types of setups.

- Velocity switch, where multisamples (or drumsamples) are cleanly switched at the threshold
- Velocity crossfades, where multisamples (or drumsamples) are smoothly crossfaded over a specified range outside the threshold
- Velocity layers, where two multisamples (or drumsamples) are layered when you play a specified range outside the threshold

**Note:** If “Oscillator Mode” is set to Drums, the velocity settings pre-specified for the drum kit will be used, and therefore will not be shown in the screen. A drum kit’s velocity zones can be edited in the Global/Media mode DRUM KIT page. (see page 111)

### Selecting Multisamples

Let’s create a simple velocity crossfade between two Multisamples, using just OSC1.

1. Select the P-OSC> MS1 page, and turn the multisample 1 Multisample On/Off parameter On.

Switching pages as necessary, turn the Multisample On/off parameter on for multisample 2, and off for multisamples 3 and 4.

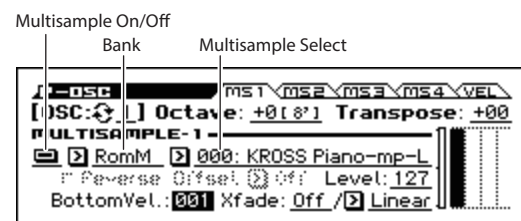

**2. Select Stereo as the Multisample Bank for multisample1 and multisample2.**

There are two main types of Multisample Banks: **Mono**, and **Stereo**. Note that stereo Multisamples will require twice as many voices as mono Multisamples.

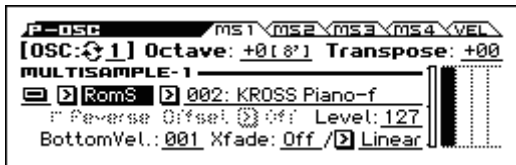

**3. Select the multisample.**

Multisamples are organized by category such as piano, guitar, bell, etc. Choose the Multisample Select parameter and press the ENTER button to see the list. Use the cursor buttons < and > to switch categories, use the cursor buttons up and down to select a multisample, and press the ENTER button to confirm your choice.

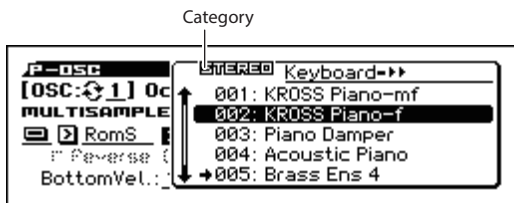

There are three types of multisamples: ROM, RAM, and option. For each type, you can select either mono (M) or stereo (S) multisamples. Note that stereo multisamples will require twice as many voices as mono multisamples.

ROM multisamples are internal preset sounds, and can always be used. They are organized by categories such as piano, guitar, and bell.

RAM multisamples can be used by converting samples that you sampled using the pad sampler.

Option multisample banks can be used if you have loaded option multisamples. The menu shows only the currently-loaded option banks.

**4. In the same way, select multisample 2 in the P-OSC> MS2 page. Select a different Multisample than what was selected for multisample1.**

Multisamples have now been assigned to multisample 1 and 2.

**5. Specify the velocity range and crossfade range.**

Set the multisample 2 “Threshold Velocity” to 001, and turn “Crossfade” Off.

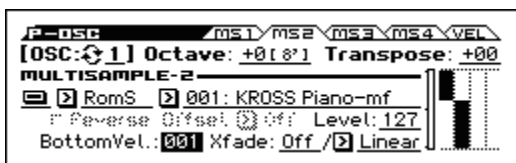

**6. In the P-OSC> MS1 page, set the velocity range (Bottom Vel.) to 80 for multisample 1.**

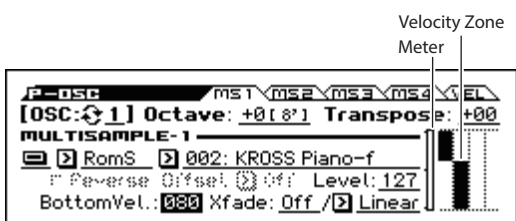

With these settings, Multisample2 will sound for notes played with a velocity of 79 or less, and Multisample1 will sound for notes played with a velocity of 80 or greater.

The Velocity Zone shows the oscillator’s four multisamples and the velocity zones of each oscillator.

The meter on the left shows the note-on velocity. This lets you see which multisample and oscillator will sound for that specific velocity.

**7. Set the multisample 1 “Xfade” to 20, and its “Curve” to Linear.**



Level

The state of this split is shown visually in the screen.

The two multisamples will fade across the range from 80 to 100, with multisample 2 fading-out while multisample 1 fades-in. This produces a smooth change without any sudden switch.

**8. As needed, use the P-OSC> MS1 page and MS2 page to adjust the Level of the two multisamples.**

**Using a drum kit**

**What is a drum kit?**

A drum kit is a collection of drum set samples such as bass drum, snare, or cymbal, as well as a variety of other percussion sounds, with a sample assigned to each key.

You’ll use Global/Media mode to create and edit a drum kit. Up to four drum samples can be assigned to each note of the keyboard, and you can use the BottomVel., Xfade, and Curve parameters to specify how you’ll switch between these samples. Then, in Program mode, you can adjust filter and amp settings, and specify effects and routing to the audio output jacks. (see page 111)

To use a drum kit in a Program, set **Oscillator Mode** to Drums, and choose one of the 58 user drum kits or the 9 GM2 drum kits.

**Selecting a drum kit**

1. Access the P-BASIC> VOICE page.
2. Set “OSC (Oscillator Mode)” to Drums.

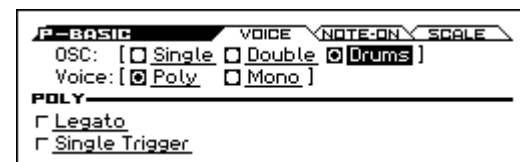

3. Select a drum kit in the P-OSC> DKit page.



4. Specify the basic pitch of the oscillator. For a drum kit, set “Octave” to +0 [8’].

## Creating time-varying changes (LFO and EG)

### Using LFOs

You can use the cyclic change produced by the LFO (Low Frequency Oscillator) to modulate numerous aspects of the sound.

Each Program has two LFOs: LFO1 and LFO2. There is also a single Common LFO, shared by both Oscillators. While LFO1 and LFO2 are separate for each voice, the Common LFO is shared by all voices in the Program. This makes it useful when you want all of the voices to have an identical LFO effect.

You can use these LFOs to modulate many different Program parameters, including:

- Pitch (for vibrato)
- Filters (for wah effects)
- Volume (for tremolo)
- Pan (for auto-panning)

The LFOs can modulate many other parameters, in addition to those listed above.

### Using the basic LFO

1. Access the P-OSC LFO> 1. WAV page.

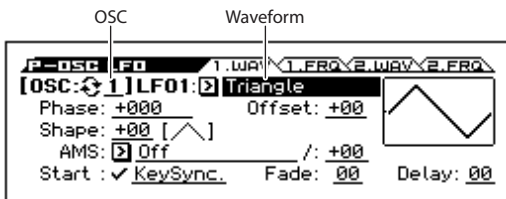

2. Select the oscillator (OSC) that you want to edit. (see page 35)

3. Select a Waveform.

Step through the various waveforms, and notice their shapes shown in the display.

There are a number of waveforms to choose from. Each are suited to different applications:

**Triangle** and **Sine** are the classic LFO shapes for vibrato, tremolo, panning, and filter wah effects.

**Square** is useful for gated on and off filter and amp effects, and can create trills when modulating pitch.

The **Guitar** waveform is designed especially for guitar vibrato; it bends only upwards from the base value.

**Saw** and **Exp. (Exponential) Saw Down** are good for rhythmic filter and amp effects.

**Random 1 (S/H)** creates the classic sample-and-hold effect, which is great for modulating a resonant filter.

4. After looking at the different waveforms, select **Triangle**.
5. Select the **Shape** parameter, and use the **VALUE** dial to move through its different settings, from **-99** to **+99**.

Notice how the shape of the waveform becomes more curved, and how **-99** emphasizes the lower part of the shape, and **+99** emphasizes the upper part.

6. Select the **Phase** parameter, and use the **VALUE** dial to sweep through its range of values.

Notice how the waveform shifts from side to side. Among other things, this lets you offset the LFOs from one another in time, which can create interesting organic effects.

7. Use the **Fade** and **Delay** settings to control the way the LFO sounds at the beginning of the note.

8. Access the P-OSC LFO> 1. FRQ page.

9. Use the **FREQUENCY** parameter to set the speed of the LFO.

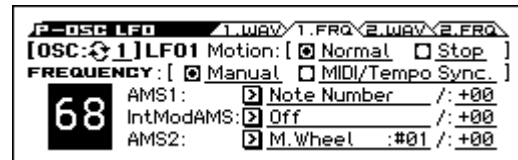

For more information on LFOs, please see page 39 of the Parameter Guide.

All of these parameters control the way that the LFO works. In order for the LFO to actually affect the sound, you can use the dedicated LFO routings on the Filter, Pitch, and Amp pages, or use the LFOs as AMS sources for a wide variety of parameters.

### Using EGs (Envelope Generators)

An envelope creates a modulation signal by moving from one level to another over a specified time, and then moving to another level over another period of time, and so on.

The Program includes three EGs, for Pitch, Filter, and Amp. These produce time-varying changes in pitch, tone, and volume respectively. They can also be used to modulate a number of other program parameters via AMS.

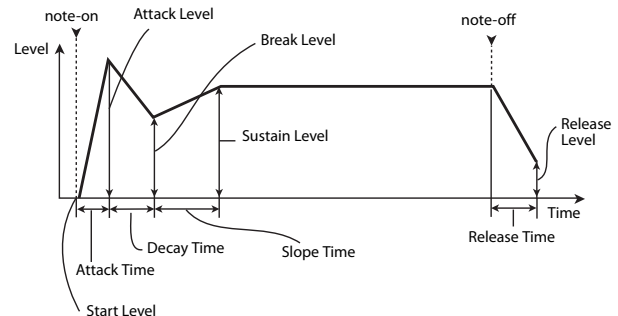

**Note:** The parameters that can be modulated by an EG and the range of values will differ depending on the EGs provided for each section.

---

## Diverse modulation settings (AMS and AMS mixer)

---

### Using AMS

AMS (Alternate Modulation Source) lets you modulate program parameters using controllers, EG, or LFO as the modulation source. Extremely creative types of modulation are possible; for example, you can use a single controller to simultaneously modulate multiple parameters, or you can use an EG to modulate an LFO's frequency and then use that LFO to modulate a filter.

AMS (Alternate Modulation Source) refers to any of the assignable modulation sources in KROSS, including:

- Controllers of the KROSS itself, such as the modulation wheel, the pitch bend wheel, and SW 1/2
- Incoming MIDI controllers
- Modulators such as the Filter, Pitch, and Amp EGs, the LFOs, or the AMS Mixers

**Intensity** is a parameter that sets the degree (speed, depth, amount etc.) of how AMS will control the modulation.

A number of frequently-used modulation routings, such as using the modulation wheel or the pitch bend wheel to vary the pitch, are provided as additional, dedicated routings, separate from AMS.

Note that not all AMS sources may be available for some modulation destinations.

For details on alternate modulation and AMS, please see below.

- “Alternate Modulation Sources (AMS)” on page 293 of the Parameter Guide
- “Creating Vibrato” on page 40
- “Pitch EG” on page 40
- “Filter EG” on page 42
- “LFO modulation” on page 42
- “AMS (Pan)” on page 32 of the Parameter Guide
- “LFO1/2” on page 43

---

### Using the AMS Mixers

The AMS Mixers combine two AMS sources into one, or process an AMS source to make it into something new.

For example, this lets you use an LFO to modulate a filter's resonance while also modulating it by an EG. Although resonance has only one AMS input, using the AMS mixer makes this possible. You could also do things such as using the filter EG to control the amount of LFO1. The wide variety of other possibilities include using the modulation wheel to control the amount of pitch EG, allowing the pitch bend wheel to apply bend only to notes played while you hold down the foot switch.

The AMS Mixer outputs appear in the list of AMS sources, just like the LFOs and EGs. An AMS mixer's output signal can be used to modulate a variety of parameters.

This also means that the original, unmodified inputs to the AMS Mixers are still available as well. For instance, if you use LFO 1 as an input to an AMS Mixer, you can use the processed version of the LFO to control one AMS destination, and the original version to control another.

Finally, you can cascade the two AMS Mixers together, by using AMS Mixer 1 as an input to AMS Mixer 2.

For details, please see “12: P-AMS MIXER” on page 45 of the Parameter Guide.

---

### Tips for using AMS

When adjusting settings for alternate modulation, think of the effect that you wish to produce, what type of modulation will be necessary to produce that effect, and what parameter of the oscillator, filter, or amplifier needs to be controlled.

Next, select a source **AMS** and set the **Intensity**. If you proceed logically in this way, you will achieve the desired effect.

For example in a guitar sound program where you want to use the modulation wheel to control the feedback, you would select assignments where the modulation wheel controls the filter frequency and resonance.

---

### Controller Setup page

For each program, the function of the SW1 and SW2 buttons can be assigned in the P-INPUT/CTRL> CONTROLLERS page.

For details, please see “Setting the functions of SW1 and SW2” on page 44.

## Controlling Pitch

### Pitch Bend

Pitch bend smoothly changes the pitch upward or downward, similar to how a guitarist can “bend” strings. On the KROSS, you can use the pitch bend wheel to control this in real time.

The amount of pitch change applied when you move the pitch bend wheel fully toward yourself or fully away from yourself is specified in semitone steps by the **Bend(+)** and **Bend(-)** settings. For example if Bend(+) is set to +12, moving the pitch bend wheel fully away from yourself will make the pitch rise one octave.

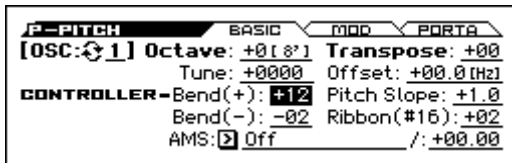

**Note:** This can also be controlled via MIDI or by using a controller other than the pitch bend wheel.

**MIDI Ribbon (#16)** specifies the amount of pitch change (in semitone units) that will occur when MIDI control change message #16 is received. With a setting of +12, a value of 127 will raise the pitch one octave, and a value of 0 will lower the pitch one octave.

### Creating Vibrato

You can use an LFO to create vibrato.

LFO1 and LFO2 **Intensity** specify how deeply the selected LFO will affect the pitch. With a setting of +12.00, vibrato will vary the pitch in a range of one octave upward and downward.

**M.Whl-Int** specifies the amount of vibrato that will be produced by the LFO when the modulation wheel is moved fully away from you.

**AMS Intensity** specifies the depth of vibrato that will be applied by the LFO when modulated by the selected AMS (Alternate Modulation Source). For example, suppose that in the P-INPUT/CTRL>CONTROLLERS page, you set **SW1** to SW1 Mod.:#80, set **LFO1 AMS** to SW1:#80, and set “Intensity” to an appropriate value; when you now turn on SW1 or receive MIDI control change CC#80, vibrato will be applied.

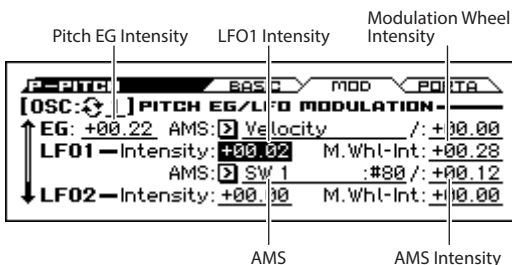

### Pitch EG

When the **Intensity** value is set to +12.00, the pitch EG specified in the Pitch EG page will produce a maximum of ±1 octave of pitch change.

To realistically simulate the slight change in pitch that occurs when a string is plucked or at the attack of a brass or vocal sound, you can use the EG to create a subtle change in pitch at the attack.

### Portamento

Portamento makes the pitch change smoothly when you play the next note before releasing the previous note.

The **Time** parameter controls how long it will take the pitch to change. As this value is increased, the pitch will change over a longer time. With a value of **000**, there will be no portamento.

You can turn Portamento on and off via SW1 or SW2, by assigning them to **Porta. SW: #65**.

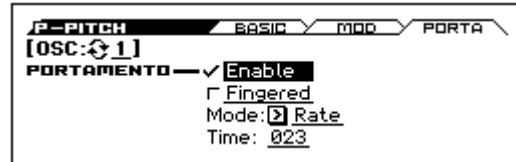

## Using Filters

The filters allow you to diminish or emphasize specified frequency areas of the sound.

**The tone of the sound will depend significantly on the filter settings.**

The basic filter settings, including the routing, type, cutoff frequency, and resonance, are set on the P-FILTER> BASIC page.

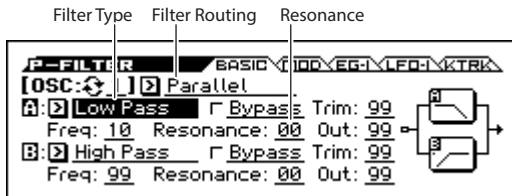

## Filter Routing

Each oscillator has two filters, Filter A and Filter B. The **Filter Routing** parameter controls whether one or both of the filters are used, and if both are used, it controls how they are connected to each other.

The **Single** routing uses only Filter A as a single 2-pole, 12dB/octave filter (6dB for Band Pass and Band Reject).

The **Serial** routing uses both Filter A and Filter B. The oscillator first goes through Filter A, and then the output of Filter A is processed through Filter B.

The **Parallel** routing also uses both Filter A and Filter B. The oscillator feeds both filters directly (and allow independent settings for each), and the outputs of the two filters are then summed together.

The **24dB(4Pole)** routing merges both filters to create a single 4-pole, 24dB/octave filter (12dB for Band Pass and Band Reject). In comparison to Single, this option produces a sharper roll-off of frequencies beyond the cutoff frequency, as well as a slightly more delicate resonance. Many classic analog synths used this type of filter.

### Serial and Parallel Routing

#### Serial

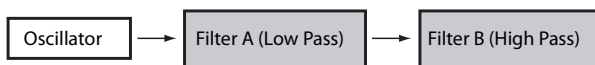

#### Parallel

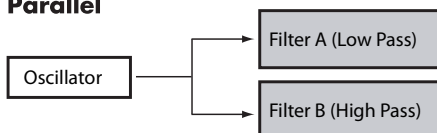

## Filter Types

This selects the parts of the sound that will be affected by the filter, as described below. With the Serial and Parallel routings, you can independently set the types for Filter A and Filter B.

The filters will produce very different results depending on the selected **filter type**.

**Low Pass:** This cuts out the parts of the sound that are **higher** than the cutoff frequency. Low Pass is the most common type of filter, and is used to make bright timbres sound darker.

**High Pass:** This cuts out the parts of the sound that are **lower** than the cutoff frequency. You can use this to make timbres sound thinner or more buzzy.

**Band Pass:** This cuts out all parts of the sound, both highs and lows, except for the region around the cutoff frequency. Since this filter cuts out both high and low frequencies, its effect can change dramatically depending on the cutoff setting and the oscillator's multisample.

With low resonance settings, you can use the Band Pass filter to create telephone or vintage phonograph sounds. With higher resonance settings, it can create buzzy or nasal timbres.

**Band Reject:** This filter type—also called a notch filter—cuts only the parts of the sound directly around the cutoff frequency. Try modulating the cutoff with an LFO to create phaser-like effects.

### Filter Types and Cutoff Frequency

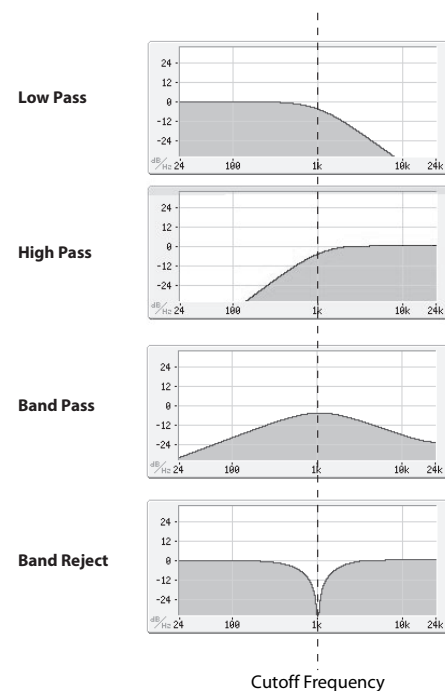

### Resonance

Resonance emphasizes the frequencies around the cutoff frequency, as shown in the diagram below.

When this is set to 0, there is no emphasis, and frequencies beyond the cutoff will simply diminish smoothly.

At medium settings, the resonance will alter the timbre of the filter, making it sound more nasal, or more extreme. At very high settings, the resonance can be heard as a separate, whistling pitch.

To make the resonance track the keyboard pitch, please see “Key Follow” on page 27 of the Parameter Guide.

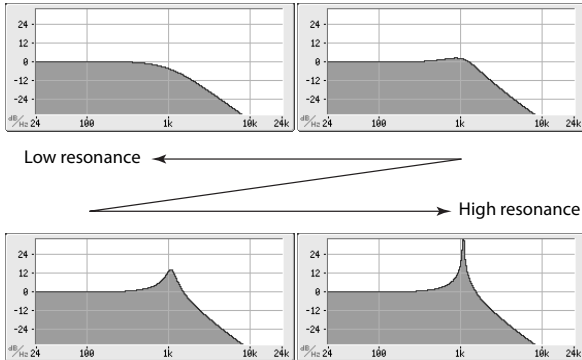

### Modulating the filters

You can modulate the filter cutoff frequency using the Filter EG, the LFOs, keyboard tracking, and other built-in and MIDI controllers. This is a great way to add a rich variety of tonal change to the sound.

#### Filter EG

The Filter EG is a multi-stage envelope, which you can use to modulate the filter as well as other Program parameters. The EG itself is set up on the P-FILTER EG> ENVELOPE page; the way that it affects the filters is controlled by the parameters described below, on the P-FILTER> EG-I (Intensity) page.

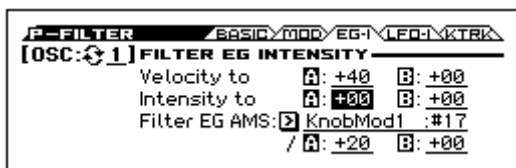

The **Intensity to A** and **Intensity to B** settings control the basic amount of EG modulation for filter frequencies A and B, respectively, before other modulation.

The **Velocity to A** and **Velocity to B** settings let you use velocity to control the amount of EG modulation.

The **Filter EG AMS** setting selects an AMS modulation source to scale the amount of the Filter EG that’s applied to Filters A and B. The two filters share a single AMS source, with separate intensity **A** or **B** settings.

### LFO modulation

You can modulate the filter via LFO1, LFO2, and the Common LFO. Among other applications, LFO modulation of the filter can produce the classic “auto-wah” effect.

The P-FILTER> LFO-I (Intensity) page lets you set up the following parameters separately for each LFO:



**Intensity to A** and **Intensity to B** specify how much the LFO changes the tone.

The **AMS** setting selects an AMS modulation source to scale the amount of the LFO applied to Filters A and B. The two filters share a single AMS source, with separate intensity settings.

For example if **AMS** is set to SW1: #80, turning SW1 on will apply an auto-wah effect. (see page 40)

### Keyboard Track

Most acoustic instruments get brighter as you play higher pitches. At its most basic application, keyboard tracking recreates this effect by increasing the cutoff frequency of a lowpass filter as you play higher on the keyboard. Usually, some amount of key tracking is necessary in order to make the timbre consistent across the entire range.

The KROSS keyboard tracking can also be much more complex, since it allows you to create different rates of change over up to four different parts of the keyboard. For instance, you can:

- Make the filter cutoff frequency increase very quickly over the middle of the keyboard, and then open more slowly—or not at all—in the higher octaves.
- Make the cutoff frequency increase as you play lower on the keyboard.
- Create abrupt changes at certain keys, for split-like effects.

#### How Key Track works: Keys and Ramps

The keyboard tracking works by creating four ramps, or slopes, between five keys on the keyboard.

For details, please see “How it works: Keys and Ramps” on page 26 of the Parameter Guide.

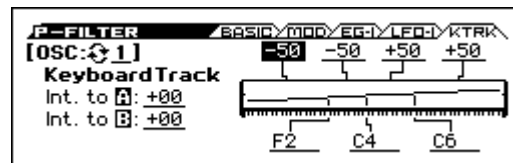



## Using the Amp section

The Amp section includes controls for volume, pan, and the driver circuit.

You can control the volume using the Amp EG, LFO 1/2, Key Track, and velocity, along with other AMS sources.

Each Oscillator has its own Amp section: Amp1 for OSC1, and Amp2 for OSC2.



## Background - what does "Amp" mean?

Different sounds have characteristic shapes to their volume levels.

For example, the volume of a piano note begins at a high volume the instant you play the note, and then decreases gradually.

The volume of an organ note, on the other hand, remains constant as long as you continue pressing the key.

The volume of a note on a violin or wind instrument can be varied during the note by the musician (i.e., by regulating the amount of pressure on the bow or the force of the breath).

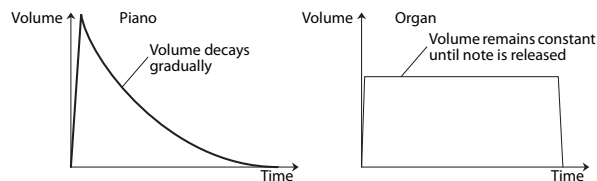

## Pan

### Pan

The main **Pan** parameter controls the stereo position after the signal has passed through the oscillator, filter, and amp.

Normally you'll set this to **C064**, so that the sound is centered equally between the left and right speakers.

To create a stereo effect when **OSC** (Oscillator Mode) is set to **Double**, set the **OSC1 Pan** to L001, and the **OSC2 Pan** to R127. This will make OSC1 go to the left speaker, and OSC2 go to the right speaker.

With a setting of **Random**, the pan will change randomly each time you play a note on KROSS, producing an interesting effect.

### Pan - DKIT-SET (Use DKit Setting)

Use **DKit Setting** applies when **OSC** (Oscillator Mode) is set to **Drums**.

If this is **checked**, the Program can use a different pan position for each drum sound, as specified by the Drum Kit. If this is **unchecked**, all drum sounds will use the Program's pan position.

The factory presets and GM drum kits use individual pan positions for the different drums, so normally it's best to leave this checked.



## Amp modulation

The basic volume level is set by the **Amp Level** parameter. You can then alter this using the modulation sources below:

### Amp Modulation

**Velocity Intensity** is used by most programs to decrease the volume of softly played notes and increase the volume of strongly played notes, and the Amp Modulation parameter adjusts the depth of this control.

Normally you will set Amp Modulation to positive (+) values. As this setting is increased, there will be greater volume difference between softly played and strongly played notes.

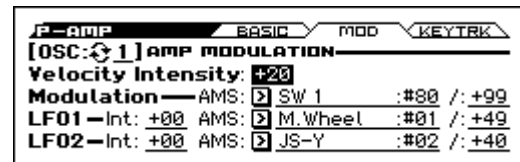

### LF01/2

Specifies how the LFO's will produce cyclic changes in volume (tremolo effect).

The volume will be affected by the LFO(s) where you set an **LF01 Int** (Intensity), **LF02 Int** (Intensity) value.

**AMS Intensity** adjusts the depth of how the tremolo effect produced by the LFO will be affected when you assign an **AMS** (LFO1 AMS, LFO2 AMS).

For example if **AMS** (LFO1 or LFO2) is set to M.Wheel:#01, a tremolo effect will be produced when the modulation wheel is moved away from yourself or when CC#1 is received.

### Keyboard Track

This lets you vary the volume relative to the note that you play.

For details, please see "Keyboard Track" on page 42.

## Amp EG

The Amp EG lets you control how the volume changes over the course of the duration of a note.

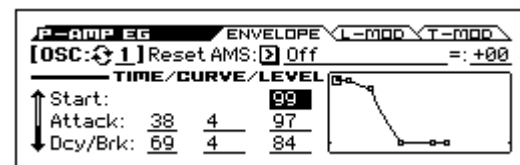

Every instrument has its own characteristic volume envelope. This is part of what gives each instrument its identifiable character.

Conversely, by changing the volume contour—for instance, applying a string-like Amp EG curve to an organ multisample—you can produce interesting and unusual sounds.

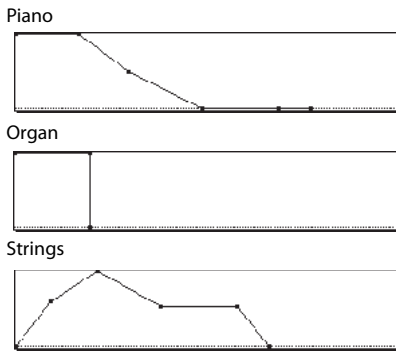

## Making controller assignments

### Setting the functions of SW1 and SW2

These on/off buttons can perform a number of different functions, such as modulating sounds or effects, or locking the modulation values of the modulation wheel.

Also, each one may work either as a toggle, or as a momentary switch. In **Toggle** mode, each press alternates between on and off; in **Momentary** mode, the switch only changes for as long as you hold it down.

Each Program, Combination, and Song stores its own settings for what the buttons will do, and whether each button is on or off (based on their current states when the data is saved).

These settings are adjusted on the following CONTROLLERS pages.

Mode	Page
Programs	P-INPUT/CTRL> CONTROLLERS
Combinations	C-INPUT/CTRL> CONTROLLERS
Sequencer	S-INPUT/CTRL> CONTROLLERS

**Note:** The on/off status of the SW1 and SW2 buttons will be preserved when you write the program or combination.

**Note:** You can use SW1/2 as alternate modulation or effect dynamic modulation sources to control program parameters or effect parameters.

To do so, you will normally assign SW1 Mod. :#80 and SW2 Mod. :#81.

For a complete list of the possible assignments, please see page 302 of the Parameter Guide.

**Note:** If you want to keep these settings after the power is turned off, you must save them. (see page 122)

## Arpeggiator settings

According to the note data that's received from the keyboard or from the MIDI IN connector, the arpeggiator will automatically generate a wide range of phrases or patterns including arpeggios, guitar or keyboard backing riffs, bass phrases, or drum patterns.

For more about the arpeggiator, please see page 73.

## Drum Track settings

You can use the KROSS's rich variety of drum patterns to accompany you with high-quality drum programs while you perform using a program.

Playing along with Drum Track patterns is often a useful way to come up with new phrases.

For more about the Drum Track function, please see page 83.

## Using the step sequencer

The step sequencer is a function that plays a KROSS drum program using a drum pattern which you can create in an intuitive way by using pads 1–16. You can play a program while listening to the rhythm produced by the step sequencer.

For more about the step sequencer, please see page 89.

## Effects

For details, please see "Using Effects" on page 67.

## Automatically importing a Program into Sequence mode

You can use the Auto Song Setup feature, which automatically copies the settings of the program or combination and puts the KROSS in record-standby mode when you simply press the ● (REC) button. Then you can press the SEQUENCER ► / ■ (start/stop) button to begin recording.

For details, please see "Auto Song Setup function" on page 60.

# Playing and editing Combinations

## About the KROSS's combinations

Combinations let you split and layer up to 16 Programs at once.

A Combination is made up of 16 Timbres (Note that you don't have to use all 16 Timbres). Each Timbre is assigned a Program, along with parameters for key range and velocity zones, mixer settings, MIDI channel and controller filtering, and so on.

This section of the manual takes a quick look at playing Combinations, including a tour of the front-panel controllers and basic editing techniques.

## Playing combinations

### Selecting Combinations

#### 1. Press the COMBI button. (LED lit)

You'll enter Combination mode.

Access the COMBI> MAIN page. The upper line of the display shows the page that you're on. If a different page is shown, press the EXIT button several times to access the COMBI> MAIN page.

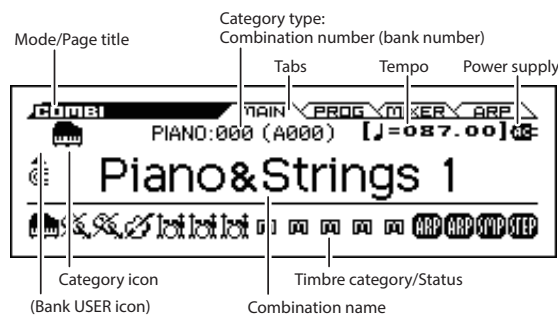

**Tip:** In the COMBI> MAIN page, you can also select combinations by using the cursor buttons ▲ ▼ or the VALUE dial.

#### 2. Turn the CATEGORY dial to select the category of combination that you want to play.

The sound select list will appear.

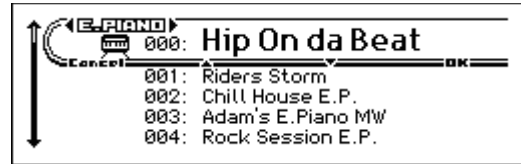

**Tip:** The sound select list will also appear when you press the ENTER button.

You can use the cursor buttons ◀ ▶ to switch categories.

#### 3. Turn the VALUE dial to select the combination that you want to play.

Play the keyboard to hear the sound.

**Tip:** You can also select programs by using the cursor buttons ▲ ▼ or the PAGE-(▲), PAGE+(▼) buttons.

#### 4. To return to the MAIN page, press the MENU (OK) button or the ENTER button to close the menu.

If you press the FUNCTION button or the EXIT button, your selection will be discarded and you'll return to the combination where you were before opening the list.

### Other ways to select combinations

In addition to using the controls on the front panel of the KROSS, you can select combinations in the following ways.

- Using a connected foot switch (see page 24)
- Receiving a MIDI program change message (from an external MIDI sequencer or MIDI controller)
- Selecting a combination that you've registered in Favorites (see page 53)

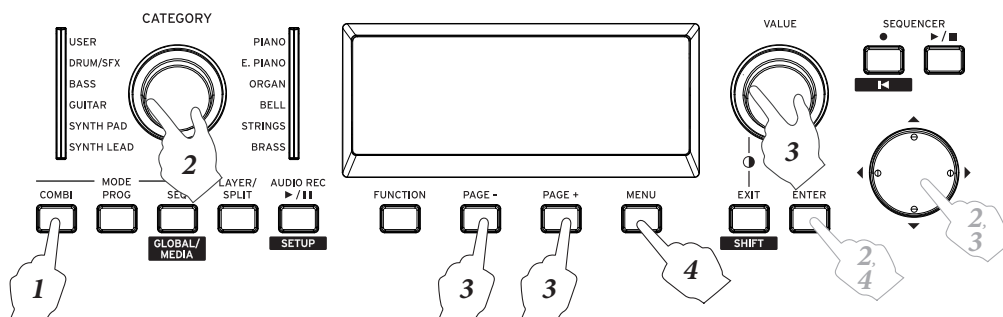

## Combination categories and numbers

The sounds of the KROSS are organized by type into categories; within each category, an index number is assigned to each sound. All combinations are also assigned a bank and combination number that are used to recall that combination via MIDI.

**Note:** Depending on the bank, there are limitations on where a combination can be saved. For details, please see “Saving data” on page 121.

### Category and index number

Category	Index number (bank number)
PIANO	000 (A000)...036 (A036)
E.PIANO	000 (A037)...032 (A069)
ORGAN	000 (A070)...021 (A091)
BELL	000 (A092)...018 (A110)
STRINGS	000 (A111)...036 (B019)
BRASS	000 (B020)...019 (B039)
SYNTH LEAD	000 (B040)...061 (B101)
SYNTH PAD	000 (B102)...059 (C033)
GIUITAR	000 (C034)...025 (C059)
BASS	000 (C060)...060 (C120)
DRUM/SFX	000 (C121)...006 (C127)
USER	000...511 (UA000...UD127)

### Index number

With the factory settings, the 384 preload combinations of banks A, B and C are organized into the categories PIANO–DRUM/SFX. Within each category, the combinations are assigned an index number starting with 000.

The 512 initialized combinations of bank UA-UD (User) are assigned to the USER category.

### Category

Combination sounds are organized into the 12 categories that are listed in the table above. A combination category icon is shown on the upper left side of the display. The [USER] category icon is shown at the left of the PIANO–DRUM/SFX icon.

### Bank number

The bank number indication shows the number used for MIDI transmission and reception. Since the conditions for saving will differ depending on the bank, this provides a helpful guide. For more about banks, please see “Bank numbers and conditions for saving” on page 121.

For details on combinations, please see the separate “Voice Name List.”

### Timbre icon information

The lower line shows icons indicating the category of the timbre, the timbre used by the arpeggiator, and the timbre used by the step sequencer.

## Using controllers to modify the sound

In addition to using the keyboard, the KROSS lets you control the sound by using the pitch bend wheel, modulation wheel, SW1 and SW2 buttons, damper pedal, and foot switch or foot pedal.

These controls let you modify the tone, pitch, volume, effects, etc. in realtime as you play.

- Pitch bend wheel, modulation wheel, SW1, SW2 buttons → p.1
- Damper pedal, foot switch/pedal → p.23
- REALTIME CONTROLS → p.15

## Performing with the arpeggiator, drum track or step sequencer

Based on the note data that it receives from the keyboard or from the MIDI IN connector, the arpeggiator can generate an arpeggio (broken chord), or produce a wide variety of phrases and patterns that are appropriate for the sound of the selected program, such as guitar or keyboard backing riffs, bass phrases, or drum patterns. A combination lets you use two arpeggiators. For more about the arpeggiator, please see page 73.

The Drum Track plays a variety of drum patterns using the drum program that you’ve assigned to the desired timbre. For more about the Drum Track, please see page 83.

The step sequencer is a function that lets you create and play drum patterns in a way that’s similar to the Drum Track. You can create and play drum patterns by turning on/off pads 1–16 located on the right side of the front panel. For more about the step sequencer, please see page 89. The step sequencer is assigned to timbre 16.

You can play a combination along with an accompaniment provided by the Drum Track and the step sequencer.

Arpeggiated phrases, the Drum Track, and the step sequencer pattern can all be synchronized, and you can also play along with them.

# Editing a combination

You can edit any of the Combinations that were shipped with the KROSS. You can create your own combinations by editing a preloaded combination, or by starting from an initialized combination.

A combination has sixteen timbres; you can assign a program to each timbre and specify its volume and pan, the key range where the program will sound, and how its sound will be routed to the effects. You can create simple setups such as detuned sounds, split, or layers, or highly complex orchestra-like setups.

**Note:** If a program you edit in Combination mode is used in Program mode, that program will sound according to its edited state.

## Summary of the edit pages

To perform detailed editing, you'll need to access an edit page in the display.

For details on how to access each mode and page, please see "Basic operations" on page 12.

Page	Tabs	Main content
COMBI	MAIN	Select and play a combination
	PROG	Select a program for each timbre and set its status
	MIXER	Timbre volume, pan, and mute settings
	ARP	Arpeggiator easy editing
C-INPUT/CTRL	AUDIO IN	External audio input settings
	CONTROLLERS	SW1 and 2 function settings and tempo setting
C-TONE ADJ	TONE ADJUST	Tone Adjust settings for each timbre
	EG ADJUST	EG (ADSR) settings for each timbre
C-TIMBRE	MIDI	MIDI channel settings for each timbre
	OSC	OSC settings for each timbre
	PITCH	Pitch settings for each timbre
	SCALE	Scale selection
C-ZONE/DELAY	KEY ZONE	Key zone settings for each timbre
	VEL ZONE	Velocity zone settings for each timbre
	DELAY	Delay time settings for each timbre

Page	Tabs	Main content
C-FILTER	1	MIDI transmit/receive filter settings for each timbre
	2	
	3	
	4	
C-ARP	ASSIGN	Arpeggiator assignments to each timbre
	A	Arpeggiator A settings
	B	Arpeggiator B settings
C-DRUM TRACK	PATTERN	Drum Track pattern selection and trigger region settings
	CHANNEL	Drum Track input/output MIDI channel settings
C-STEP SEQ	BASIC	Step sequencer program selection and length settings
	EDIT	Step on/off entry
	INST	Instrument settings
	MOD	Step sequencer settings such as accent and swing
C-FX ROUTING	BUS	Bus assignments from each timbre to the insert effects
	SEND	Send amounts from each timbre to the master effects
	IFX	Insert effect type selection and chain settings
	MIXER	Post-insert effect routing settings
C-IFX	IFX1	Insert effect 1-5 settings
	IFX2	
	IFX3	
	IFX4	
	IFX5	
C-MFX	SETUP	Master effect type selection and chain settings
	MFX1	Master effect 1 and 2 settings
	MFX2	

The structure of a combination, and the related pages

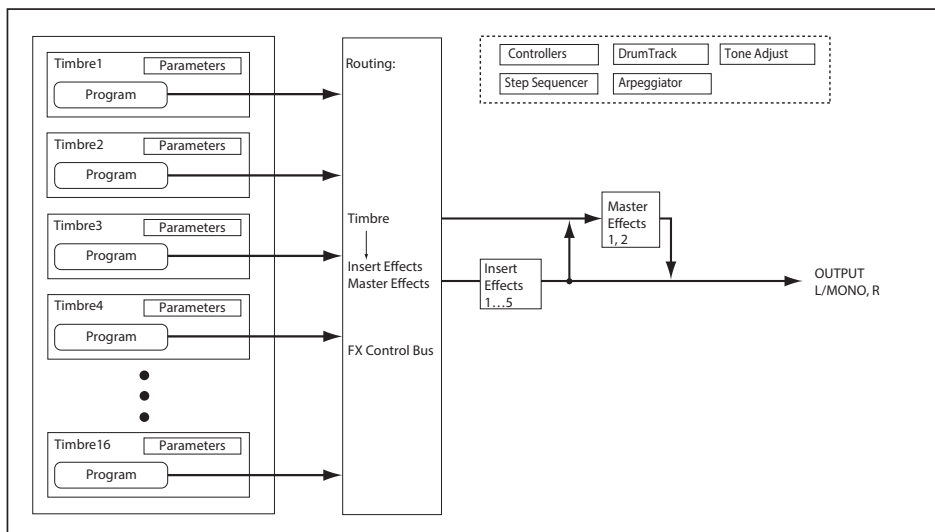

## A suggested approach for editing

First select the program that each timbre will use, and set each timbre's MIDI channel to Gch (global MIDI channel) and its Status to INT so that it can be played from the keyboard.

Next, create any desired keyboard or velocity switch, layers, or crossfades between the different Timbres.

After this, adjust the volumes of the Timbres, and set up any other Timbre parameters as desired.

To add finishing touches to the sound, set up the Insert, and Master Effect as desired. These effects can be different from those associated with the individual Programs in Program mode, if desired.

In addition, you can make arpeggiator and drum track settings and controller settings to create the finished Combination.

**Note:** You can use a function to copy effect and arpeggiator settings from a program. (see page 96 of the Parameter Guide)

### Soloing a timbre

You can use the COMBI> PROG page Solo Setting function to hear the sound of an individual timbre. (see page 32)

## Comparing with the sound before you started editing

### Using COMPARE

When you're in the process of editing a sound, pressing the COMPARE button will recall the saved version of the sound, as it was before you started editing.

For details, please see "Compare/Undo function" on page 13.

## Changing the program of each timbre

Changing the Programs that are assigned to timbres (1–16) is a quick way to dramatically alter the sound of the Combination.

### 1. Access the COMBI> PROG page.

Press the PAGE+ or PAGE- button to select the page.

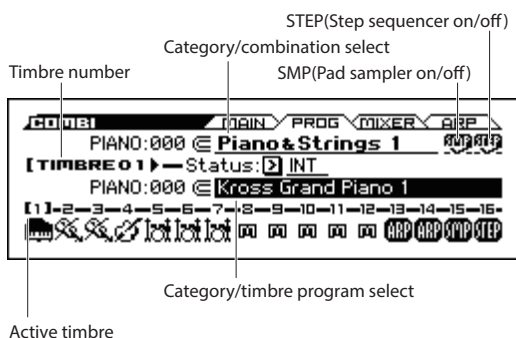

### 2. Press the cursor button ▼ to choose category/timbre program select (it will be highlighted).

3. Use the cursor buttons ◀▶ to select the timbre whose program you want to switch.
4. Turn the CATEGORY dial to select a category.
5. Turn the VALUE dial.
6. Press the MENU (OK) button or the ENTER button to confirm your choice.

**MIDI** You can also switch programs by receiving MIDI program changes from a connected external MIDI device. (see page 316 of the Parameter Guide)  
To select the timbre program via MIDI program change the timbre's status must be set to "INT."

## Adjusting the mix

### Adjusting the volume of each timbre

#### 1. Access the COMBI> MIXER page.

Press the PAGE+ or PAGE- button to select the page.

In this page you can view and edit the pan and volume of timbres 1–16.



2. Press the cursor button ▼ to choose Volume (it will be highlighted).
3. Use the cursor buttons ◀▶ to select the timbre whose volume you want to adjust
4. Use the VALUE dial etc. to adjust the setting.

**Note:** If you check **Hold Balance** function, moving any one of the volume sliders (volume values) will cause the volume of the other timbres to change as well, maintaining the relative volume balance between timbres 1–16. This is a convenient way to adjust the overall volume.

### Adjusting the panning of each timbre

#### 1. Access the COMBI> MIXER page.



2. Use the cursor buttons ▲▼ to choose Pan (it will be highlighted).
3. Use the cursor buttons ◀▶ to select the timbre whose pan you want to adjust
4. Use the VALUE dial etc. to adjust the setting.

**Note:** Timbre pan interacts with the pan stored in the Program. A setting of C064 reproduces the Program's oscillator pan settings. Adjusting the Timbre Pan will move the sound to left or right while preserving the pan relationship between the oscillators. A setting of L001 is far left, and R127 is far right.

## Using the Tone Adjust and EG Adjust functions

The Tone Adjust function is an easy way to adjust the sound of each timbre.

In the C-TONE ADJ> TONE ADJUST page you can adjust parameters such as the cutoff and resonance; in the C-TONE ADJ> EG ADJUST page you can adjust the attack time and release time.

These adjustments will not affect the original program or the sound of programs that are used by other combinations.

### 1. Access the C-TONE ADJ> TONE ADJUST page or the EG ADJUST page.

Press the MENU button to access the page menu. Use PAGE+ (▼) and PAGE- (▲) to select “C-TONE ADJ,” and press the MENU (OK) button.

Press the PAGE+ or PAGE- button to select the page.

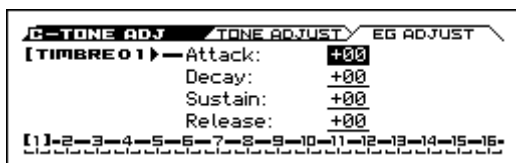
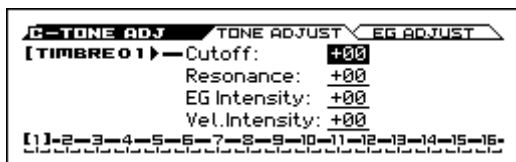

2. Use the cursor buttons ◀▶ to select the timbre whose sound you want to adjust
3. Use the cursor buttons ▲▼ to select the sound parameter that you want to edit.
4. Use the VALUE dial etc. to edit the value.

For details on these parameters, please see page 31.

## Saving a Combination you’ve edited

After you’ve edited a combination, you must save it if you want to keep the changes you’ve made. If you re-select the combination or turn off the power before saving, your edits will be lost.

For details, please see “Writing a Program or Combination” on page 122.

You can also save combinations on an SD card as PCG files.

For more details, please see “Saving to SD card” on page 125.

## Using REALTIME CONTROLS to adjust the sound or effects

You can use the realtime controls to edit in a variety of ways. For example, you can modify the cutoff or resonance.

You can also change the effect depth, or modify the phrase that's generated by the arpeggiator. (→ p.32)

**Note:** In Combination mode, the sound edited by the TONE 1, TONE 2, or EFFECT rows of parameters that you select using the realtime control section's SELECT button cannot be saved. If you want to save the sound, use the equivalent parameters of the Tone Adjust or EG Adjust functions.

## Layers, Splits, and Velocity Switches

Within a Combination, you can use note range and the velocity level to define the “zone” where a specific timbre will play.

The Programs assigned to each Timbre can be played in three ways: as part of a **layer**, a **split**, or a **velocity switch**. A Combination can be set to use any one of these methods or to use two or more of these methods simultaneously.

**Tip:** In Program mode it’s easy to make layer or split settings for two programs. (see “Quick Layer/Split function” on page 29)

### Layer

Layers cause two or more Programs to play simultaneously when a note is played.

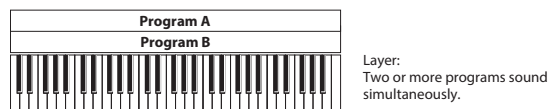

### Split

Splits cause different Programs to respond on different areas of the keyboard.

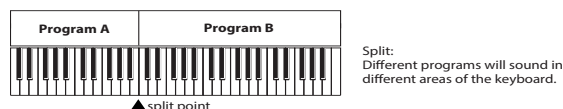

### Velocity Switch

Velocity Switches cause different Programs to respond depending on the velocity (how hard you play the notes).

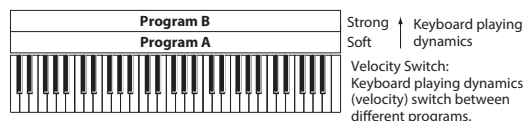

On the KROSS, you can use a different Program for each of up to sixteen Timbres, and combine two or more of the above methods to create even more complex setups.

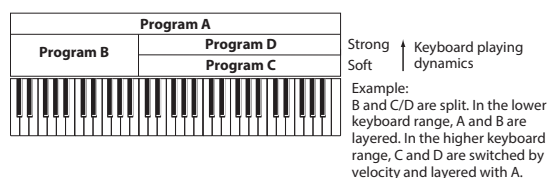

As an additional possibility, you can set the slope for a key zone or velocity zone so that the volume diminishes gradually. This lets you change a split into a keyboard crossfade, or a velocity switch into a velocity crossfade.

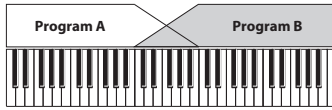

Keyboard X-Fade (keyboard crossfade):  
As you play from low notes to high notes, the volume of A will fade out, and the volume of B will fade in.

## Creating Splits and Layers

### Splits and Layers

Let's create a Combination that combines both splits and layers, like the diagram below:

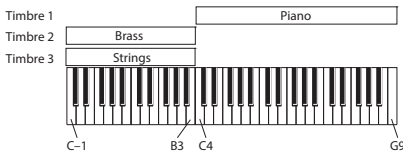

1. Access the COMBI> PROG page.
2. Select a piano sound for Timbre 1, a brass sound for Timbre 2, and a string sound for Timbre 3.



3. For timbres 1-3, set Status to INT.



4. Access the C-TIMBRE MIDI page.
5. For timbres 1-3, set the MIDI Channel to Gch (Global channel).

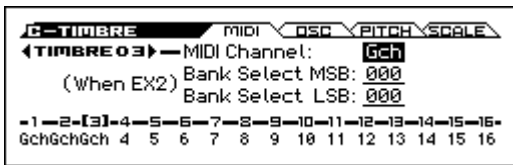

6. Access the C-ZONE/DELAY> KEY ZONE page.
7. For timbre 1, set "Top Key" to G9 and Bottom Key to C4.

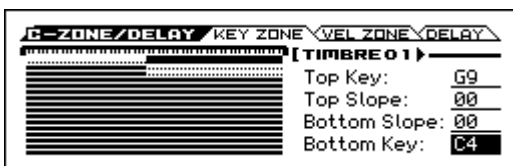

You can also enter a note value by moving the cursor to the parameter in the display, then holding down the ENTER button and pressing a note on the keyboard.

8. For timbre 2 and timbre 3, set the Top Key to B3 and the Bottom Key to C-1.

## Key Zone Slope

In addition to "hard" splits, where the sound changes abruptly, you can use the Slope parameters to gradually fade a sound in or out over a range of keys.

We'll make some changes to the example shown above.

1. In the example above, you could set the Bottom Key of timbre 1 to G3, and set the Top Key of timbre 2 to G4, so that these two timbres overlap.
2. Next, if you set the Bottom Slope of timbre 1 to 12, and set the Top Slope of timbre 2 to 12, the sound will change gradually instead of changing suddenly.

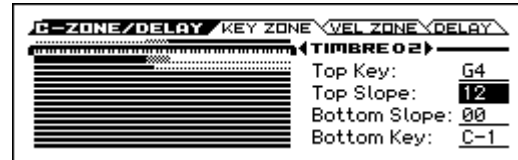

## Creating Velocity Switches

Next, let's create a simple velocity switched Combination, like the diagram below:

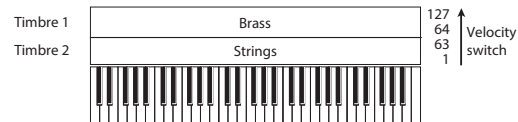

1. Access the COMBI> PROG page.
2. Select a brass sound for Timbre 1, and a string sound for Timbre 2.
3. For timbres 1 and 2, set the Status to INT.
4. Access the C-TIMBRE MIDI page.
5. For timbres 1 and 2, set the MIDI Channel to Gch (Global MIDI channel).
6. Access the C-ZONE/DELAY> VEL ZONE page.
7. For timbre 1, set the Top Velocity to 127 and the Bottom Velocity to 64.

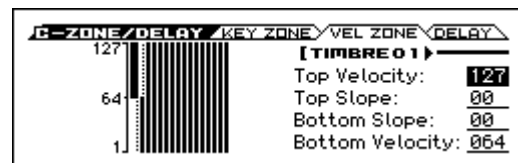

8. For timbre 2, set the Top Velocity to 63 and Bottom Velocity to 1.

## Velocity Zone Slope

Similar to Key Zone Slopes, as described above, these let you fade sounds in and out gradually over a velocity range, instead of a simple hard switch.

We'll make some changes to the example shown above.

1. Set the velocity zones of the two timbres so that they partially overlap.
2. Set the Top Slope and Bottom Slope so that the sound changes gradually, rather than abruptly between velocity values 63 and 64.



## Status settings

Adjust these settings in the COMBI> PROG page.

This controls the status of MIDI and the internal tone generator for each Timbre. Normally, if you're playing an internal Program, this should be set to **INT**.

If the status is set to **Off**, **EXT**, or **EX2**, that Timbre's internal sounds will not be played. **Off** simply disables the Timbre entirely. The **EXT** and **EX2** settings allow the Timbre to control an external MIDI device.



For details, please see "Status" on page 71 of the Parameter Guide.

## MIDI settings

### MIDI Channel

Adjust these settings in the C-TIMBRE> MIDI page.

Timbres that you wish to play from the KROSS's keyboard must be set to the global MIDI channel. Your playing on the keyboard is transmitted on the global MIDI channel, and will trigger any timbre that matches this channel. Normally you will set this to **Gch**. When this is set to **Gch**, the MIDI channel of the timbre will always match the global MIDI channel, even if you change the global MIDI channel.

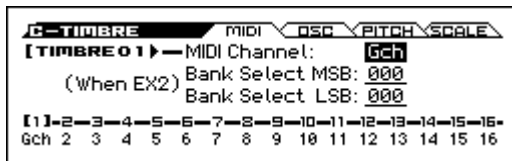

⚠ On some preloaded Combinations, Timbres used by the arpeggiator may have their MIDI Channels set to something other than **Gch**. These will be timbres that play only when the arpeggiator is on, which is a very useful technique for creating "Arpeggiator based" Combinations.

For details, please see "Arpeggiator settings in Combination and Sequencer modes" on page 76. In particular, note the relationships between arpeggiator A/B assignments and the MIDI Channel.

### Bank Select (when status=EX2)

When the **Status** (COMBI> PROG) is set to **EX2**, these parameters allow you to transmit MIDI Bank Select messages to external MIDI devices.

### MIDI filter settings

Adjust these settings in the C-MIDI FILTER> 1-4 pages.

For each MIDI Filter item, you can specify whether or not the corresponding MIDI message will be transmitted and received. The **checked** items will be transmitted and received.

The MIDI filters don't turn the functions themselves on or off. Instead, the filter just controls whether or not that MIDI message will be transmitted and received.

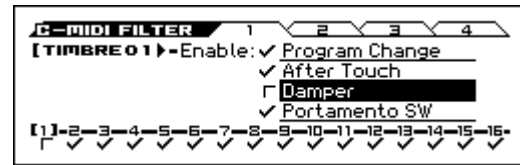

For example, if portamento is on, portamento will be applied to the internal KROSS sound even if Enable Portamento SW is unchecked.

As another example, let's say that you've selected a bass Program for Timbre 1, and a piano Program for Timbre 2, with the goal of creating a bass/piano split. You could choose the following settings so that pressing the damper pedal affects only Timbre 2's piano sound:

1. Access the **C-MIDI FILTER> 1** page.
2. Un-check the **Dampers (Enable Damper)** box for **Timbre 1**.
3. Check the **Dampers (Enable Damper)** box for **Timbre 2**.

## Changing the program settings to match the combination

You can make various changes to Programs within the context of a particular Combination to make them fit better with other Programs, or to create particular sonic effects. These changes do not affect the original Programs, or how those Programs sound in other Combinations. (see page 77 of the Parameter Guide)

### Timbre oscillator settings



Adjust these settings in the C-TIMBRE> OSC page.

#### Force OSC Mode

If you wish to force a polyphonic program to sound monophonically, set this either to **Mono** or **Legato**. Conversely, set this to **Poly** if you wish to force a monophonic program to play polyphonically.

Normally this should be set to **PRG**, so that the sound will play as set by the original Program.

For details, please see "Force OSC Mode" on page 77 of the Parameter Guide.

#### OSC Select

If the timbre is using a Program where the **Oscillator Mode** is **Double**, and you want only OSC1 or OSC2 (not both) to sound, set this to **onlyOSC1** (only OSC1 will sound) or **onlyOSC2** (only OSC2 will sound). Conversely, specify **onlyOSC2** if you want only OSC2 to produce sound. If you want to use the unchanged settings of the program so that the original sound is heard, set this to **OSC1&2**.

Normally, this should be set to **OSC1&2**.

### Portamento

If the Program uses portamento, but you'd like to disable this for the current Combination, set this parameter to **Off**.

Conversely, if you want to force the portamento to be on, or just to change the portamento time, set this to a value of **001–127**. The portamento will change to use the newly specified time.

Normally, this should be set to **PRG**.

### Pitch settings

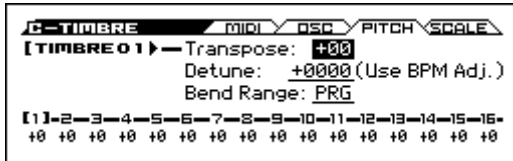

#### Transpose, Detune (BPM Adjust)

These parameters adjust the pitch of the timbre. Adjust these settings in the C-TIMBRE> PITCH page.

- In a layer-type combination, you can set two or more timbres to the same program, and create a richer sound by using **Transpose** to shift their pitch apart by an octave or by using **Detune** to create a slight difference in pitch between the two.
- In split-type combinations, you can use **Transpose** to shift the pitch (in semitone units) of the programs specified for each key zone.

**Note:** If you wish to change the playback pitch of a drum program, use **Detune**. If you change the **Transpose** setting, the relationship between the notes and drum sounds will change.

### Scale selection

#### Use a Program's Scale, Scale Type (timbre scale and overall scale)

This specifies the scale for each timbre. Adjust these settings in the C-TIMBRE> SCALE page.

If you **check Use Program's Scale**, the scale specified by the program will be used. Timbres where this parameter is **not checked** will use the **Scale** setting.

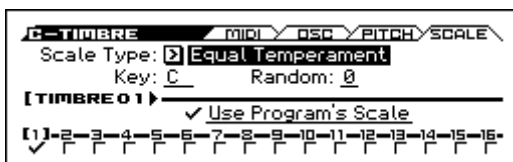

### Delay

You can set some Timbres so that they don't sound immediately at note-on. This can create cool effects, and more dramatic layers. Adjust these settings in the C-ZONE/DELAY> DELAY page.

You can specify the delay for each Timbre either in milliseconds (ms), or in rhythmic values which sync to the system tempo.

If you set the Delay to **Key Off**, the Timbre will sound when the note is released.

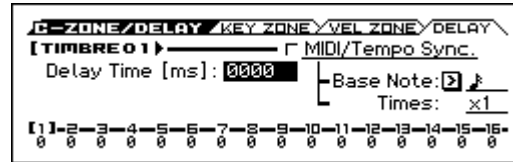

### Arpeggiator settings

According to the note data received from the keyboard or from the MIDI IN connector, the arpeggiator will automatically generate a wide range of phrases or patterns including arpeggios, guitar or keyboard backing riffs, bass phrases, or drum patterns. A combination lets you use two arpeggiators.

For more about the arpeggiator, please see page 73.

### Drum Track settings

While you perform using a combination, you can use the KROSS's rich variety of drum patterns to play high-quality drum programs.

Playing along with Drum Track patterns is often a useful way to come up with new phrases.

You can select the drum program that you want, and specify how it will start.

For more about the Drum Track function, please see page 83.

### Using the step sequencer

In a combination, the step sequencer uses the drum program of timbre 16. You can use pads 1–16 to intuitively create drum loop patterns and play them.

For more about the step sequencer, please see page 89.

### Effects

For details, please see "Using Effects" on page 67.

### Automatically importing a combination into Sequence mode

You can use the Auto Song Setup feature, which automatically copies the settings of the program or combination and puts the KROSS in record-standby mode when you simply press the SEQUENCER ● (REC) button. Then you can press the SEQUENCER ►/■ (start/stop) button to begin recording.

For details, please see "Auto Song Setup function" on page 60.

# Favorites function

## What is the Favorites function?

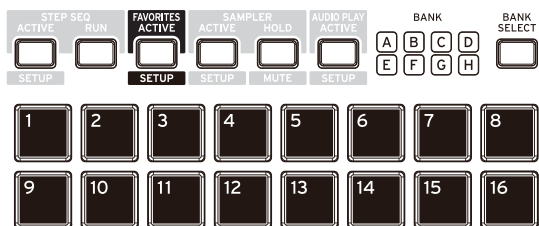

This function lets you register your favorite combinations or programs using the 16 front panel pads so that you can recall them instantly.

You can also register MIDI program changes to a favorite, as a way to easily recall sounds on an external MIDI device.

## Using the Favorites function

### Recalling a favorite sound

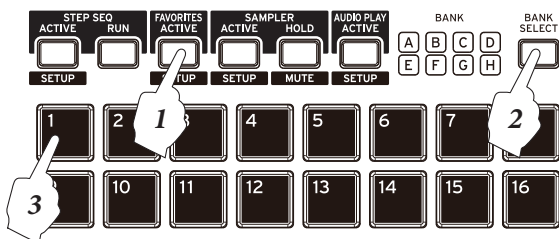

1. Press the FAVORITES ACTIVE button to turn on the Favorites function. (FAVORITES ACTIVE button lit up)

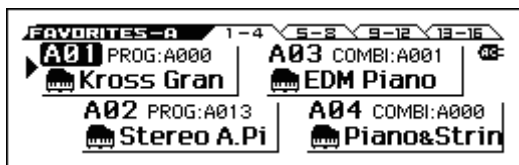

2. Press the BANK SELECT button to select a bank. (BANK LED lit up)
3. Press one of the 1–16 pads to select a favorite. The sound or settings you registered will be recalled. (Button lit up)

**Note:** You can use the VALUE dial or the cursor buttons ◀▶▲▼ to recall favorites consecutively.

**Note:** You can use a foot switch or MIDI foot controller to recall favorites. (see page 23, and page 303 of the Parameter Guide)

**Note:** To turn off the Favorites function, press any one of the PROG, COMBI, or SEQ buttons.

## Registering a sound in Favorites

There are two ways to register a sound as a favorite.

- Directly register a sound as a favorite
- Modify an existing favorite registration

The two procedures are described below.

2. If you want to keep the registrations and settings that you made for the Favorites function, you must save them before you turn off the power. To save these settings, execute the Write Favorites function. (see “Saving your Favorites” on page 54)

### Directly registering a favorite sound

Here’s how the sound that you’ve selected in Program mode or Combination mode can be directly registered as a favorite.

1. In Program mode or Combination mode, select a sound. (see pages 27, 45)

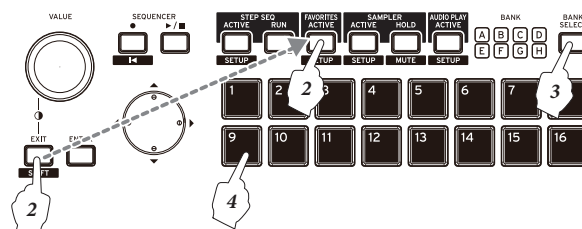

2. Hold down the EXIT button and press the FAVORITES ACTIVE button to enter registration mode. The display indicates "Add to Favorite," and the bank LEDs and pads 1-16 blink.

**Note:** If you decide not to register the sound, press the EXIT button.

3. Use the BANK SELECT button to select a bank.
4. Press one of the 1–16 pads to register the sound to that button.

### Add to Favorite function

You can also register a favorite by executing the Add to Favorite function in Program mode or Combination mode.

Instead of step 2 described above, press the FUNCTION button to access the function list, use the PAGE– (▲) and PAGE+ (▼) buttons to select Add to Favorite, and press the MENU (OK) button to execute. Use steps 3 and 4 described above to register the favorite.

### Modifying an existing favorite registration

In this method, you specify the favorite number, and change the currently-registered sound to a different sound.

This method is convenient if you already know the sounds you want and the order that you want to register them (for example piano in A01 and organ in A02), so that you can step through the favorites and change them consecutively.

1. Select a favorite whose sound you want to change. (See “Recalling a favorite sound”)
2. Press the ENTER button to access the EDIT FAVORITE dialog box. The bank LED and the 1–16 pads you’ve selected will start blinking.

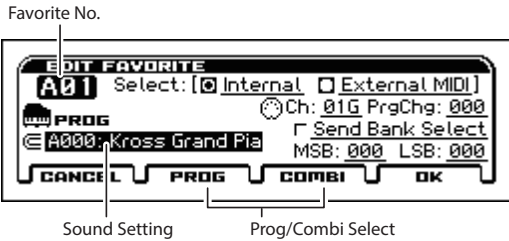

**Note:** If you decide not to make the change, press the EXIT button.

3. Select a sound. In the same way as usual when selecting a sound, use the CATEGORY dial and the VALUE dial to select a sound.

As when selecting a program or combination, you can also press the ENTER button and choose from the list that appears. Select a sound in the list, and press the ENTER button to confirm.

To switch between programs and combinations, use the PAGE- (PROG) and PAGE+ (COMBI) buttons.

4. When you've found the sound that you want to register, press the MENU (OK) button. The registration will be changed to the new sound.

## Changing the order of favorites

If you want to change the order of the favorites you've registered, you can do so by using the Copy Favorite, Insert Favorite, and Delete Favorite functions.

For details on how to use these functions, please see page 14.

1. Use the Copy Favorite function to copy the selected favorite to the clipboard.
2. Select the favorite where you want to insert the copied favorite. Use the Insert Favorite function to insert the favorite from the clipboard.

**Note:** All favorites existing after the position where you inserted will be moved back one space within that bank. The favorite at the last position in the bank (16) will disappear.

3. To delete the selected favorite, use the Delete Favorite function.

**Note:** All favorites existing after the one you deleted will be moved forward one space within that bank. The last position in the bank (16) will become an initialized favorite.

**Note:** If you execute this function with the All Favorites check box selected, all favorites will be deleted.

## Convenient ways to use favorites

Here are some ways to take advantage of favorites for even more convenience. For each favorite, you can adjust the following settings.

- Change the sound that's registered (see "Modifying an existing favorite registration" on page 53)
- Specify a program change and bank select that will be transmitted via MIDI

You can adjust these settings by editing the favorite. To edit a favorite, proceed as follows.

## Specifying a program change

1. Access the edit page as described in steps 1 and 2 of the "Modifying an existing favorite registration" section on page 53.

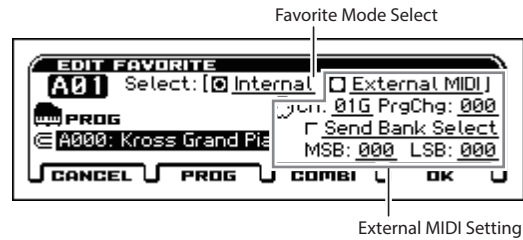

2. In the edit screen, specify the parameters for each favorite.

If you want to recall a sound on an external MIDI device, adjust the appropriate Favorites Mode Select settings.

Choose Internal if you want to play one of the KROSS internal sound generator's sounds. When you register a sound from the front panel, that favorite is automatically specified as Internal. When you recall a favorite that's specified as Internal, the program change that's assigned to that favorite will be transmitted. (E.g., A-3=002, B-1=016)

Choose the External MIDI setting if you want to recall a sound on an external MIDI device. The internal sound generator will be disabled, and will not produce sound.

**Note:** If you want to simultaneously switch and play sounds on the internal sound generator as well as an external MIDI sound module, use a combination with the EXT or EX2 settings. (see page 71 of the Parameter Guide)

## Saving your Favorites

When you've finished registering sounds to buttons, save your Favorites settings. If you turn off the power without saving your settings, they will be lost.

1. Press the FAVORITES ACTIVE button to turn on the Favorites function.

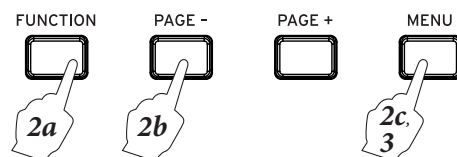
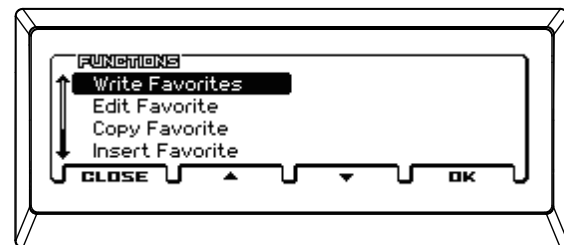

2. Press the FUNCTION button, use the PAGE- (▲) button to select the Write Favorites function, and press the MENU (OK) button.
3. Press the MENU (OK) button. The settings will be saved.

# Sequencer

## Overview

### About the KROSS's Sequencer

The sequencer brings together the KROSS's numerous functions such as its arpeggiator, Drum Track, Step sequencer, high-performance effects, and controllers, allowing you to take advantage of these in a wide range of situations.

This sequencer is a 16-track MIDI sequencer that can store up to 128 songs and 210,000 MIDI events. You can use it to record and play back notes for the internal sound generator as well as for external MIDI sound modules.

⚠ When you turn off the power, the settings that were created in Sequencer mode as well as the song data that you recorded will not be backed up. If you wish to keep this data, you must save it on an SD card before turning off the power.

If you wish to write the programs, track parameters, effects, and arpeggiator settings etc. that were used for a song as a template song, use the **Save Template Song** function.

Immediately after the power is turned on, the KROSS will not contain any song data, so if you wish to play a song on the sequencer, you must first load data from an SD card, or receive a MIDI data dump from a MIDI filer. For details, please see page 127, and page 178 of the Parameter Guide.

### Sequencer mode structure

Sequencer mode is structured as follows.

A song consists of tracks 1–16, a tempo track, song parameters such as the song name, arpeggiator, Drum Track, Step sequencer function, and effect parameters.

Tracks 1–16 consist of setup parameters (such as each track's program, pan, and volume) located at the start of the song, and the musical data itself. The tempo track consists of tempo and time signature data. (see "Setup parameters & Musical data" on page 100 of the Parameter Guide)

### Song recording and editing

You can record in real time onto tracks 1–16. Realtime recording gives you a choice of six recording modes.

You can edit tracks 1–16 in units of tracks or measures, and you can also edit individual notes and other events. For example, you can use functions such as Create Control Data to insert a pitch bend, aftertouch, or control change data.

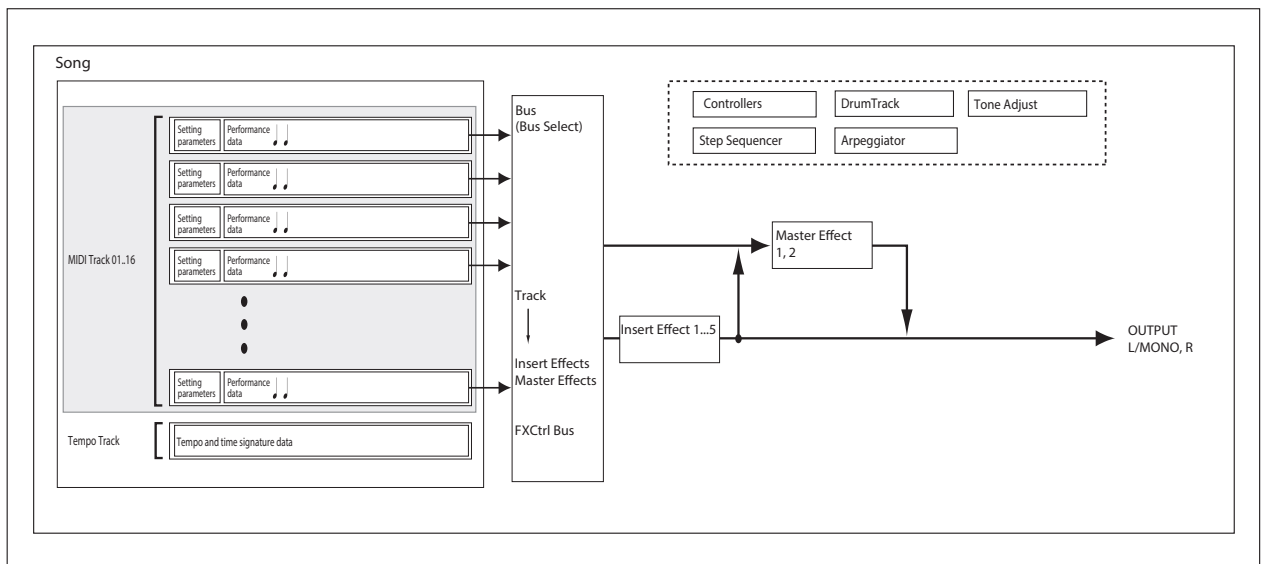

# Playing back

## Playback methods

In order to play back song data in the sequencer, you must first, load song data into the KROSS.

First, let's load a demo song that contains preload data, and play it back.

### Loading a song (demo song)

#### 1. Execute "Loading the preloaded data" on page 131

This procedure will load program and combination data and demo song data into the KROSS. This means that any data you've edited or newly created will be overwritten and lost. If you want to keep this data, save it on an SD card (commercially available) before you continue.

**Tip:** To load song data that you saved on an SD card, see "Loading songs for use in Sequencer mode (.SNG)" on page 127.

### Playing back a song

#### 1. Press the SEQ button to enter Sequencer mode.

The SEQ> MAIN or SEQ> PROG page will appear. If this is not displayed, press the EXIT button three times.

#### 2. Use "Song Select" to select the song that you want to play back.

You can also select a song by using the ENTER button, the cursor buttons ▲▼, and the VALUE dial.

However if there is no song, you can't make a selection using these controllers.

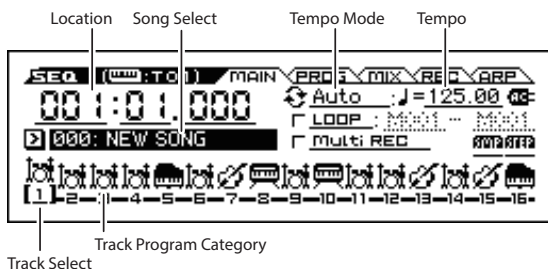

#### 3. Press the SEQUENCER button (start/stop) button.

Song playback will begin.

The location indicator towards the upper left of the display shows the currently playing measure and beat.

#### 4. During playback, you can press the SEQUENCER button (start/stop) button to stop playback.

If you press the SEQUENCER button (start/stop) button once again, playback will resume from where you stopped.

To fast-forward or rewind, hold down the SEQUENCER button (start/stop) button and press the cursor button (fast-forward) or (rewind).

You can use the FF/REW Speed function to specify the fast-forward and rewind speed. (Please see page 142 of the Parameter Guide)

**Note:** Track Select chooses the track that will be played by the keyboard.

### Specifying the playback start location

By pressing the EXIT button (SHIFT) and the SEQUENCER (REC) button (◀), you can move (locate) to a specified location. By default, you'll move to 001:01.000.

You can use the song command "Set Location" to change this location. (see page 142 of the Parameter Guide)

### Loop playback

#### Looping all tracks simultaneously

By selecting the LOOP check box, you can make the song play or record in a loop. In this example, we'll loop measures 10 through 13 of the demo song.

#### 1. In Sequencer mode, access the SEQ> MAIN page.

#### 2. Add a check mark to LOOP (Loop All Tracks).

Use the cursor buttons ◀▶▲▼ to select the parameter, and press the ENTER button.

#### 3. Set the measure from which you want to start looping (the Loop Start Measure) to 10, and the measure at which you want to stop looping (the Loop End Measure) to 13.

Use the cursor button ▶ to select each parameter, and use the VALUE dial to specify the value.

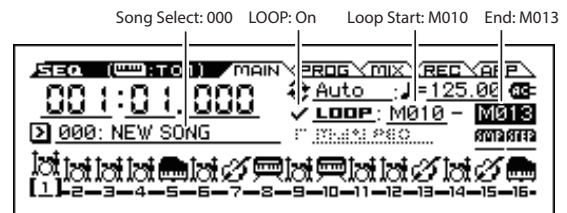

#### 4. Press the SEQUENCER button (start/stop) button to play back the demo song.

Measures 10 through 13 will play repeatedly.

#### Individually looping a track

During song playback or recording, you can make a currently-playing track loop individually.

As an example, try the following settings.

**Note:** Turn LOOP (Loop All Tracks) off. For more about Solo settings, see page 57.

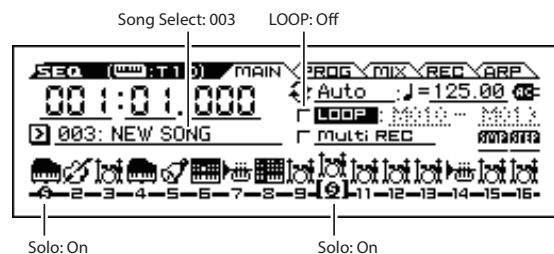

#### 1. In Sequencer mode, access the S-LOOP/TONE> LOOP page.

Press the MENU button, select S-LOOP/TONE from the menu, and press the MENU (OK) button.

#### 2. Select track 1 as the track where you're adjusting settings.

Press the cursor button ◀ to make the track number towards the upper left side of the display indicate TRACK 01.

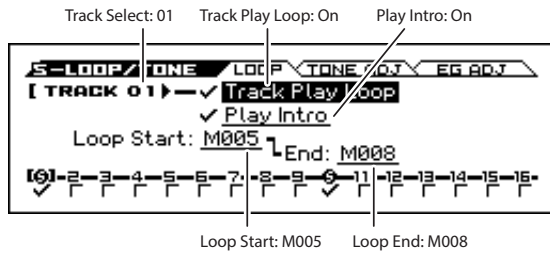

**3. Turn on Track Play Loop.**

Use the cursor button ▲ to select the parameter, and press the ENTER button to add a check mark.

If a check mark is shown, the specified region of measures will loop during playback or recording.

**4. Turn on Play Intro.**

Use the cursor button ▼ to select the parameter, and press the ENTER button to add a check mark.

If a check mark is shown, playback will start from the first measure of the intro, and then the specified region of measures will repeat.

**5. Set the Loop Start to M005, and the Loop End to M008.**

Use the cursor button ▼ to select each parameter, and use the VALUE dial to specify the value.

**6. Using the procedure described above, adjust settings for track 10 as shown in the illustration below.**

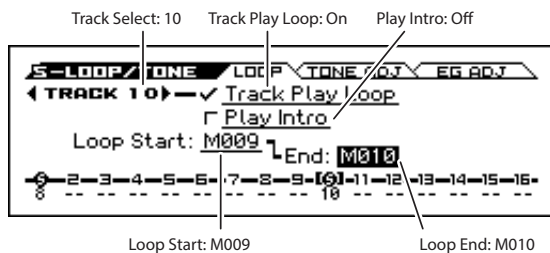

If you play back from the first measure with the settings shown in the screenshot above, the specified region of measures will repeat as follows.

Measures	1	2	3	4	5	6	7	8	9	10	11	12	13
Track 1	1	2	3	4	5	6	7	8	9	10	11	12	13
Track 10	9	10	9	10	9	10	9	10	9	10	9	10	9

If **Play Intro** is unchecked, the specified region of measures will repeat as follows.

Measures	1	2	3	4	5	6	7	8	9	10	11	12	13
Track 1	5	6	7	8	5	6	7	8	5	6	7	8	5
Track 10	9	10	9	10	9	10	9	10	9	10	9	10	9

**Changing the volume, and pan settings of each track**

In the SEQ> MIX page you can change the volume, and pan settings of each track.



**Muting a specific track/Monitoring a specific track (Mute/Solo functions)**

The KROSS provides a Mute function that lets you silence specified tracks between 1–16, and a Solo function that lets you hear the specified track or channel by itself. These functions can be used in various ways. For example you can intentionally mute or solo specific tracks, or listen only to the rhythm section of the previously-recorded tracks while you record new tracks. Let’s try out the Mute and Solo functions.

**1. Press the SEQUENCER ► / ■ (start/stop) button.**

**2. Access the SEQ> MIX page. Press the PAGE+ or PAGE- button to select the page.**

**3. Use the cursor ▲ button to select Sound.**

**4. Use the cursor buttons ◀ ▶ to select the track that you want to mute. Select track 1.**

**5. Press the ENTER button to switch between Play and Mute.**

The display will change from P (Play) to M (Mute), and the playback of track 1 will no longer be heard. In this way, the “mute” function allows you to silence a specified track until the track is un-muted.

**6. Press the cursor ► button to select track 2, and press the ENTER button to switch it to Mute.**

The playback of track 2 will also be muted. To cancel muting, press the ENTER button again.



**7. Turn on Solo for track 1.**

Press the FUNCTION button, select Solo Setting from the menu, and press the OK button. The Solo Setting dialog box will appear.

Use the cursor button ▼ to select Solo, and use the cursor button ◀ to select Track 01. When you press the ENTER button to add a check mark, the screen will indicate (S); now you’ll hear only the playback of track 1. In this way, you can play only a specific track that you want to hear.

If both Mute and Solo are used, the Solo function will be given priority.

Use the cursor button ► and the ENTER button to turn Solo on for track 2. The indication will change, and you’ll hear the playback of tracks 1 and 2. MIDI tracks 3–16 will not be heard.

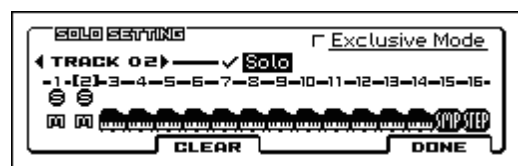

**8. To turn off the Solo feature, press the ENTER button once again. Turn off Solo for MIDI tracks 1 and 2.**

The display will change, and the playback of tracks 1 and 2 will be muted. If the Solo function is turned off for all tracks, playback will be according to the Sound settings.

⚠ The Solo is not stored when you save the song.

### Exclusive Solo

Exclusive Solo is a function that limits the Solo function (described above) to a single track at a time. If Exclusive Mode has a check mark, only the track for which Solo was last turned on will play; all other tracks will be silent.

## Recording

The sequencer of the KROSS can record your keyboard performance and use of controllers such as the modulation wheel and pitch bend wheel in real time.

Usually you will use Single Track Recording to record one track at a time.

**Note:** In addition to Single Track Recording, you can also use Multi-Track Recording. (see page 61)

## Preparations for recording

⚠ Before you begin recording, make sure that the memory protect setting in Global/Media mode is turned off. For details, please see “Protecting the memory” on page 116.

### Selecting a song

1. Press the SEQ button to enter Sequencer mode.
2. Choose “Song Select” (e.g., in the SEQ> MAIN page).

Use the cursor buttons ◀▶▼▲ to choose Song Select, and use the VALUE dial to select a song.

**Note:** Immediately after the power is turned on, there will be a single initialized song. If there is only one song, you won't be able to select other songs.

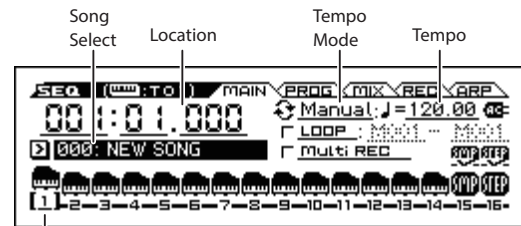

Track Select

### Track settings

Assign a program to each track, and specify its volume.

**Tip:** Here we are explaining how to adjust these basic settings step by step, but in the section that follows we will tell you how these settings can be adjusted automatically.

- “Using template songs” on page 59
- You can also use “Copying the settings of a combination or program” on page 60.

1. Assign a program to each track.

Press the PAGE+ button to access the SEQ> PROG page.

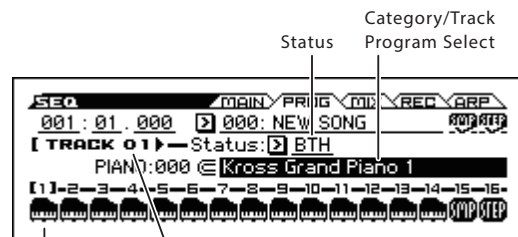

Track Info.

Track Select

Use the cursor button ▼ to choose Program Select.



Use the cursor buttons ◀▶ to select the track whose program you want to specify. Use the CATEGORY dial and VALUE dial to choose a program. The procedure is the same as when assigning a program to each timbre of a combination. (see page 48)

**Tip:** You can copy various settings from Programs or Combinations. (see pages 138, 139 of the Parameter Guide)

## 2. Use Status to specify whether each track will play the internal and/or external sound generator.

Normally when using the KROSS, you will select INT or BTH.

**INT:** During playback, the KROSS's internal tone generator will play the MIDI data recorded on that track. When you use the KROSS's keyboard or controllers, you will be playing and controlling the track selected by **Track Select**.

**EXT, EX2, BTH:** During playback, the MIDI data recorded on that track will be transmitted from the MIDI OUT to play an external sound module. When you use the KROSS's keyboard or controllers, MIDI data will be transmitted to play and control the external sound module selected by **Track Select**. The MIDI channel of the external tone generator must be set to match the **MIDI Channel** (S-TRACK> MIDI page) of KROSS tracks that are set to EXT, EX2 or BTH.

If **Status** is set to BTH, both the external tone generator and internal tone generator will be played and controlled.

## 3. Set the pan and volume of each track.

Press the PAGE+ button to access the SEQ> MIX page. Use the cursor button ▼ to choose Pan or Volume.

Use the cursor buttons ◀▶ to select the track whose settings you want to edit.

**Pan** sets the pan position of each track, and **Volume** sets the volume level of each track.



## 4. Specify the MIDI channel that each MIDI track will play.

Access the S-TRACK> MIDI page. Press the MENU button to select S-TRACK. Move to the appropriate page.

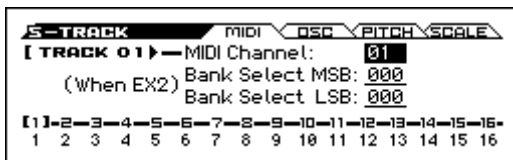

Use **MIDI Channel** to specify the MIDI channel for each track. Normally you will set the **MIDI Channel** to a different channel: 1–16 for each track. Tracks that are set to the same MIDI channel will sound simultaneously when you record or play back either of the tracks.

## 5. Adjust the effect settings.

Use the S-FX ROUTING, S-IFX, and S-MFX pages to adjust settings in each page.

(see “Effect settings for a combination or song” on page 70)

## 6. Set the tempo and time signature.

- To set the tempo, select TEMPO in REALTIME CONTROLS. To set the tempo, either turn KNOB 1 (TEMPO) or press the SWITCH (TAP) button at the desired interval. Alternatively, you can select ↓ (Tempo) in the SEQ> MAIN page (or similar page), and use the VALUE dial to set the tempo. Set Tempo Mode to Manual.
- Next you will set the time signature. In this example, we'll explain how to set the time signature using the “Time Sig (Time Signature)” field. Normally, you specify the time signature before recording the first track, and then begin recording.
  - a) Access the SEQ> REC page.
  - b) Press the SEQUENCER ● (REC) button, and set “Time Sig (Time Signature)” to \*\*/\*\*.
  - c) Press \*\*/\*\* to highlight it, and use the VALUE controllers to set the time signature.
  - d) Press the SEQUENCER ▶/■ (start/stop) button to begin recording. When the pre-count has ended and Locate reaches 001:01.000, press the SEQUENCER ▶/■ (start/stop) button to stop recording. The time signature you specified has now been recorded on the Tempo track. If you press the SEQUENCER ▶/■ (start/stop) button during the pre-count, the time signature won't be recorded.

## 7. Adjust other settings as needed.

Adjust settings for the arpeggiator (S-ARP page) and the MIDI filter (S-MIDI FILTER page). (see page 76)

If you want, you can make adjustments to the sound by using the Tone Adjust function (S-LOOP/TONE> TONE ADJ, EQ ADG pages).

When you've finished the above settings, basic setup is complete.

## Saving your song parameter settings

The song parameter settings that you create here can be saved as a template. If you use these settings frequently, you can simply load one of the templates you've saved.

For details, please see “Save Template Song (Save as User Template Song)” on page 140 of the Parameter Guide.

## Using template songs

Loading a template song is an easy way to create settings appropriate for a particular musical style. You can also assign a drum pattern to a track at the same time.

1. In the SEQ> MAIN page, press the FUNCTION button, choose Load Template Song from the menu, and press the MENU (OK) button. A dialog box will appear.



2. In the “From” field, choose the template song you want to load.
3. If you check “Copy Pattern to Track too?,” a dialog box for copying a drum track pattern will automatically appear after you execute the “Load Template Song” operation.

If you execute the command without checking this, only the template song you selected in step 2 will be loaded.

4. Press the MENU (OK) button to load the template song, or press the FUNCTION (CANCEL) button if you decide to cancel.

When you perform this operation, song settings other than Track Play Loop will be copied.

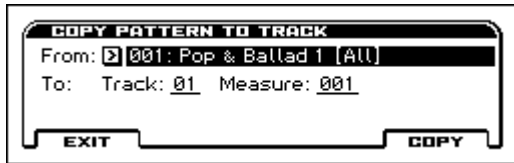

5. In the “From” field, select the pattern that you want to copy.

To actually hear the currently selected pattern, press the SEQUENCER ► / ■ (start/stop) button.

In the **To Track** field, select the copy-destination track.

In the **Measure** field, specify the starting measure of the copy-destination.

Following the pattern name for each of the 700 preset patterns, the musical style and the name of the most suitable Drum category program are partially displayed.

By loading a drum track and the corresponding preset pattern, you can instantly set up a drum track appropriate for each preset template song.

6. To execute this operation, press the MENU (COPY) button.

When you execute this procedure, the **Measure** field will count up automatically, showing how many measures of the selected pattern have been placed in the selected song. You can then copy another pattern if desired, or add more measures of the same pattern. When you’re finished, press the FUNCTION (EXIT) button.

## Copying the settings of a combination or program

You can copy the settings of a combination or program into the sequencer.

This can be done in the following ways.

- **Auto Song Setup**  
Auto Song Setup is a function that copies the settings of the selected combination (in Combination mode) or program (in Program mode) to the song in Sequencer mode.
- **Copy From Combination or Copy From Program** functions. (see pages 138, 139 of the Parameter Guide)  
In Sequencer mode, you can use these functions to copy the desired settings.

### Auto Song Setup function

1. Enter Combination mode.
2. In COMBI> MAIN page, select the desired combination and edit the Arpeggiator etc. as desired.  
*Note:* If you want to save the edited state of the combination, use the **Write Combination** functions.
3. Press the SEQUENCER ● (REC) button. Alternatively, select the “Auto Song Setup” function. The **Setup to Record** dialog box will appear.



4. To execute the Auto Song Setup function, press the SEQUENCER ● (REC) button or the MENU (OK) button. If you decide not to execute, press the CANCEL button.

You will automatically move to Sequencer mode, and the settings of the combination will be copied to the song.

- ⚠ The step sequencer’s RUN on/off setting and the Drum Track’s on/off setting when Trigger Mode is set to “Start Immediately” will not be copied. If you want to use these settings, press the appropriate buttons to turn them on.

The first unused song will be the copy-destination song.

5. The KROSS will automatically enter record-ready mode, and the metronome will sound according to the Metronome setting. (see page 110 of the Parameter Guide)
6. Press the SEQUENCER ► / ■ (start/stop) button to begin realtime recording. To stop recording, press the SEQUENCER ► / ■ (start/stop) button once again.

## Copy From Combination and Copy From Program functions

In Sequencer mode, you can use these functions to copy combination or program settings to a song.

If you select all of the check boxes in the dialog box, the same settings will be copied.

## Creating a new song

1. Press the SEQ button. You’ll enter Sequencer mode.
2. Press the FUNCTION button, choose the Create New Song function from the menu, and press the MENU (OK) button (SEQ> MAIN page, etc.). A dialog box will appear.

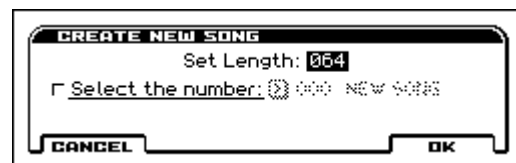

3. Enter the number of measures in Set Length.  
You can change the number of measures later if necessary. (see “Set Song Length” on page 142 of the Parameter Guide)
4. If you add a check mark to “Select the number,” you’ll be able to specify the number of the new song. If there is no check mark, the song will be numbered consecutively.
5. Press the MENU (OK) button to create the song.

## Recording MIDI in real time

When you've finished with the "Preparations for recording" section you can start recording.

This is a method of recording what you're playing on the keyboard and your controller usage, in real time. This method of recording is normally used one track at a time, and is called single track recording.

As an alternative, multitrack recording allows you to simultaneously record multiple channels of data onto multiple tracks. This is the method you will use when using the Drum Track function, the Step sequencer function, and the arpeggiator to record multiple tracks of musical data at once, or when you play back existing sequence data on an external sequencer and record it onto KROSS's sequencer in real time.

### Recording setup

In SEQ> REC page **Recording Setup**, select the realtime recording method that you want to use.

#### Overwrite

By default, this recording method is selected.

This will record your performance by overwriting any previously recorded data. All data following the measure where you start recording will be erased.

Normally you will use this method to record, and then modify the results by using other types of real-time recording or MIDI event editing.

#### 1. Use Track Select to choose the track that you want to record.

Play the keyboard; you'll hear the selected track.

#### 2. Set the Recording Setup to Overwrite.

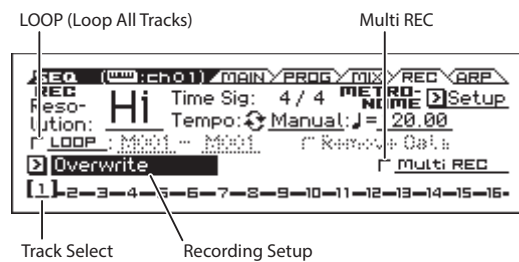

#### 3. Press the SEQUENCER ● (REC) button, and then press the SEQUENCER ► / ■ (start/stop) button.

If the **Metronome Setup** is still set to the default settings, the metronome will sound for a two-measure pre-count, and then recording will begin. Play the keyboard and move controllers such as the Modulation wheel to record your performance.

#### 4. When you finish playing, press the SEQUENCER ► / ■ (start/stop) button.

Recording will end, and the location will return to the point where you started recording.

The following recording setup parameters are also available.

#### Overdub

Select this method if you wish to record additional performance data by overdubbing it without erasing the previously-recorded data.

#### Manual punch-in

Select this method when you wish to use the SEQUENCER ● (REC) button or a foot switch to re-record selected portions of a previously-recorded track.

#### Auto punch-in

Select this method when you wish to automatically re-record selected portions of a previously-recorded track.

Then, recording will occur only over the specified area (**Auto Punch In Start Measure–Auto Punch In End Measure**), rewriting it with the newly recorded data.

#### Loop (Loop All Tracks)

Select this method when you wish to repeatedly record over a specified area of a track, while continuing to add data. This is suitable for creating drum patterns, etc.

For details, please see "An example of realtime recording".

#### Multi Rec (multitrack recording)

Use MIDI multi-track recording if you want to simultaneously record multiple tracks of different channels, such as when recording the output of the drum track, arpeggiator or Step sequencer functions, or when recording from an external multi-track sequencer.

### Recording resolution

Set the "REC Resolution" if necessary. When you record in real time on a track, this parameter specifies how the timing of the recorded MIDI data will be corrected.

Adjust these settings in the SEQ> REC page.



For example if REC Resolution is set to ♩, the timing of your realtime-recorded notes will be automatically adjusted as shown in section "2" of the following illustration whenever it varies from 8th note intervals.

If **REC Resolution** is set to Hi, the notes will be recorded with the timing at which you play them.



**Tip:** To correct already-recorded data, use the Quantize function.

First, access the S-TRACK EDIT > SELECT MEASURE TO EDIT page. Then specify the target of quantization and the range of measures, and select the Quantize function. Specify the steps that will be corrected and the strength of correction, and then apply quantization. If you want to return to the state prior to quantizing, use the Undo function from the function list.

## An example of realtime recording

In this example, we'll assign a drum program to track 01 and create the following one-measure drum phrase.



### 1. Create a new song, and specify a drum program for track 01.

Use **Track Select** to select track 01, and verify that you hear a drum program. (see page 58)

### 2. Access the SEQ> REC page. In Recording Setup, specify “Loop (Loop All Tracks)” and set it to M001-M001.

With this setting, measure 1 will be recorded repeatedly. The newly recorded data will be added at each pass.

### 3. Set “REC Resolution” to ♩.

### 4. Press the SEQUENCER ● (REC) button, and then the SEQUENCER ► / ■ (start/stop) button.

The metronome will sound a two-measure count-down, and then recording will begin.

### 5. As shown in the musical example printed above, start by playing the C3 note of the keyboard to record the bass drum for one measure.

### 6. Next, play the E3 note of the keyboard to record the snare for one measure, and then the F#3 note to record the hi-hat.

**Tip:** Pressing the SEQUENCER ● (REC) button (lit) while recording will pause recording. At this time, the REC button blinks. When you press the SEQUENCER ● (REC) button once again, recording resumes.

### 7. Press the SEQUENCER ► / ■ (start/stop) button to stop recording.

### 8. Play back the result, and listen to the drum performance that you recorded.

Press the SEQUENCER ► / ■ (start/stop) button. When you've finished listening, press the SEQUENCER ► / ■ (start/stop) button once again to stop playback.

### 9. If you're not satisfied with your performance, you can select the Undo function to return to the state prior to recording. Record again from step 4.

**Note:** When you've finished recording, clear the LOOP (Loop All Tracks) check box, and set Recording Setup to the Overwrite setting that you normally use.

In addition, access the S-LOOP/TONE> LOOP page, check **Track Play Loop** for track 01, and set the **Loop Start Measure** and **Loop End Measure** to 001. When you play back, track 01 will repeatedly play the first measure.

## Performing with the arpeggiator drum track or step sequencer

Based on the note data it receives from the keyboard or from the MIDI IN connector, the arpeggiator can generate a wide range of phrases and patterns including arpeggios, guitar or keyboard backing riffs, bass phrases, or drum patterns. You can use two arpeggiators simultaneously. For more about the arpeggiator, please see page 73.

The Drum Track plays a variety of drum patterns using the drum program that you've assigned to the desired track. For more about the Drum Track, please see page 83.

You can select the drum program that you want, and specify how it will start.

The step sequencer uses the drum program of track 16. You can use pads 1–16 to intuitively create drum loop patterns and play them. For more about the step sequencer, please see page 89.

## Recording your pad sampler performance

By assigning a MIDI channel to the pad sampler, you can record your pad performance as note data on a track.

Select a song, and in the MAIN page, turn “SMP” on; the timbre that's assigned to track 15 is disabled (does not sound), and instead the on/off events of the pad sampler are recorded as note-on/off events of the MIDI channel that's assigned to track 15.

If “SMP” is off, the track 15 timbre can be used as usual.

**Note:** It is not possible to change the track used for the pad sampler to any setting other than 15.

## Recording System Exclusive events

Exclusive messages received from an external MIDI device or the parameter changes produced when you edit a track parameter or effect parameter can be recorded in real time on any track.

During playback, the exclusive messages you recorded will control the track parameters and effect parameters of the song, and can be sent to external MIDI devices.

**MIDI** GM, XG, and GS exclusive messages can be recorded on a track, but the KROSS's tone generator will not respond to these messages.

## Using realtime controls to record changes in a MIDI track's pan, EQ, volume, and tone adjust

By controlling the pan, EQ, volume, and tone adjust parameters during realtime recording, you can record these changes so that they will be reflected during playback.

Use multi-track recording if you want to modify the settings of multiple tracks simultaneously.

**Note:** Controlling these parameters will transmit control change or system exclusive messages. In order for this data to be recorded, the G-MIDI> FILTER **Enable Control Change** and **Enable Exclusive** settings must be checked. Go to Global/Media mode and verify that these items are checked.

**Note:** Use **Param. MIDI Out** in G-MIDI> OUT page to specify whether control change messages or system exclusive messages will be transmitted when you edit the Pan (CC#10), Volume (CC#7), or Send 1/2 level (CC#93 and CC#91) parameters.

## Recording internal parameter changes

You can use SysEx for automation of internal KROSS effects and Program parameters.

Here we'll explain how to record internal parameter changes. As an example, we'll explain how parameter changes recorded on a different track can be used to modify the parameters of the insert effect (IFX1) applied to the program of track 1.

**Note:** In order to record system exclusive messages, make sure that the G-MIDI> FILTER setting **Enable Exclusive** is checked. Go to Global/Media mode and verify that this is checked.

### 1. Select the desired program for MIDI track 1, and route it to IFX1. Then record a phrase of about sixteen measures.

- In the SEQ> PROG page, use “Program Select” to select the desired program for MIDI Track 01.
- In the S-FX ROUTING> BUS page, route the Track 01 **Bus** to IFX1. Then in the S-FX ROUTING> IFX page, select the desired effect for IFX1.
- Select Track 01 in Track Select. Then press the the SEQUENCER ● (REC) button, and then the SEQUENCER ► / ■ (start/stop) button, and record a phrase of about sixteen measures.

### 2. Select Track 09 in “Track Select,” and record parameter changes as desired.

**Note:** For this example, select an empty track. If you want to record onto a MIDI track that already contains data, set the SEC> REC page **Recording Setup** to “Overdub.”

- Select Track 09 in Track Select. Then press the SEQUENCER ● (REC) button, and then the SEQUENCER ► / ■ (start/stop) button, and begin recording.
- At the appropriate time while recording, adjust the parameter(s) that you want to realtime-record.

In the S-FX ROUTING> IFX page, select another effect for IFX1, and modify the effect parameter values.

**Note:** In addition to effect parameter changes, you can also record parameters such as sound parameters. For details on the parameters that can be recorded, please see page 152 of the Parameter Guide.

### 3. Stop recording.

**Note:** Exclusive messages are always recorded on the current track selected by **Track Select**. In this example, they are recorded on MIDI track 9.

**Note:** In the event edit page you can view the recorded exclusive events and their location. Exclusive events are displayed as “EXCL”.

To view these events, go to the S-TRACK EDIT page, and select the **MIDI Event Edit** function. Then in the Set Event Filters dialog box, check Exclusive and press the OK button.

- ⚠ Exclusive events cannot be changed to a different type of event. Nor can other events be changed into exclusive events.

### 4. If you go to the page (e.g., S-FX ROUTING> IFX) that shows the parameters you've adjusted in realtime, you can watch the recorded changes be reproduced while the song plays back.

## Exclusive messages that will be recorded during realtime recording

The following exclusive messages will be recorded. (see page 152 of the Parameter Guide)

- Exclusive messages received from an external MIDI device.
- Parameter changes in Sequencer mode.
- Master Volume universal system exclusive messages assigned to a foot pedal.

## Song editing

You can apply a variety of editing procedures to a song. The available types of editing procedures are listed below.

---

### Song

**Load (Save) Template Song:** Loads a song template into the song (or saves a song as a template). (see page 59)

**Copy From Combination/Copy From Program:** Copies the settings of the specified combination/program to the settings of the song that's currently selected.

**Copy From Song:** This command copies all of the settings and musical data from the specified song to the song that's currently selected.

**Rename song:** Renames the selected song. You can enter up to 24 characters.

**Delete Song:** This command deletes the currently selected song.

**FF/REW Speed:** This allows you to set the speed at which fast-forward or rewind will occur.

**GM Initialize:** This command transmits a GM System On message to the Sequencer mode, resetting all MIDI tracks to the GM settings.

**Set Song Length:** This command changes the length of the specified song.

**Copy Measure:** This command copies the measures of musical data specified as the "From" source to the beginning of the measure specified as the "To" location. When you execute the Copy Measure command, the existing track data at the copy destination will be rewritten.

**Move Measure:** This command moves the specified measures of performance data to another measure.

**Create/Erase Control:** The Create Control command creates control change, aftertouch, pitch bend, or tempo data in the specified region of a MIDI track or the tempo track. The Erase Control command erases data such as control changes, aftertouch, pitch bend, or tempo in the specified range.

**Quantize:** This command corrects the timing of MIDI data of the type you specify (note data, control change, aftertouch, pitch bend, program change, etc.) in the track. You can also adjust for swing.

**Shift/Erase Note:** This command shifts (moves) or erases the specified note numbers in a specified MIDI track and range of measures.

**Modify Velocity:** This command modifies the velocity values of notes in the specified area so that they will change over time according to a selected curve.

**Rename Track:** This command renames the selected track. You can enter up to 24 characters.

---

### Tracks

**Event Edit:** Here you can edit individual events of MIDI data.

**Erase Track:** This command erases the data from the specified track.

**Copy/Bounce Track:** The Copy Track command copies musical data from the copy source track to the specified track. The Bounce Track command combines the musical data of the bounce source and bounce destination tracks, and places the combined data in the bounce destination. All musical data in the bounce source will be erased.

**Erase Measure:** This command erases the specified type(s) of musical data from the specified range of measures. The Erase Measure command can also be used to remove only a specific type of data. Unlike the Delete Measure command, executing the Erase Measure command does not cause the subsequent measures of musical data to be moved forward.

**Delete Measure:** This command deletes the specified measures. When the Delete Measure command is executed, the musical data following the deleted measures will be moved towards the beginning of the sequence.

**Insert Measure:** This command inserts the specified number of measures into the specified track. When you execute the Insert Measure command, the musical data following the insert location will be moved backward.

**Repeat Measure:** This command repeatedly inserts the specified measures for the specified number of times. When you execute the Repeat Measure command, the measures will be inserted following the measure specified by **To End of Measure**, and musical data following the inserted data will be moved backward.

## Saving your MIDI song

In order to ensure that the data you create is reproduced faithfully, we recommend that you save your data by using the **Save All** command so that the programs will also be saved. However if you have not changed the program numbers or sounds used in your song, saving only the song-related data (.SNG) will minimize the size of the data.

 When you turn off the power, the Sequencer mode settings and the recorded songs data will be lost.



### 1. Insert an SD card in the SD card slot.

With the card label facing upward, insert the connector end of the card into the SD card slot and press it in until you hear a click.

 Make sure that the card is oriented correctly when you insert it. Forcing it in the wrong direction may damage the slot or the card, and the data may be lost.

### 2. Hold down the EXIT button ( ) and press the SEQ button ( ) to enter Global/Media mode.

### 3. Press the MENU button and select the MEDIA tab; the MEDIA>FILE page appears.

*Tip:* When the Global/Media mode GLOBAL tab is displayed, you can once again hold down the EXIT button (  ) and press the SEQ button (  ) to jump to the MEDIA tab.

### 4. Press the FUNCTION button. Press the PAGE– or PAGE+ buttons to choose Save All.

### 5. Press the MENU (OK) button.

The Save All (PCG and SNG) dialog box will appear. If you want to change the name, you can do so. (see page 124)

### 6. Press the MENU (OK) button to save (write) the data.

If data of the same name already exists, a message will ask whether you want to overwrite the existing data. If you want to overwrite the existing data, press the MENU (OK) button.

## Saving a template song

If there are sounds or settings that you use frequently for songs, it's convenient to save them as a template song.

Use the **Save Template Song** function to do this.

*Note:* The saved data will contain settings for the programs that are selected for the song, as well as the track parameters, effect settings, and arpeggiator settings.





# Using Effects

## An overview of the KROSS's effects

You can choose from 134 different types of high-quality digital effects. The KROSS provides five insert effects, and two master effects, together with a mixer section that controls the routing of these effects. All of these are stereo in/out.

Specific parameters of these effects can also be controlled in real time from the KROSS's controllers or via MIDI messages using Dynamic Modulation (Dmod), by MIDI/Tempo Sync, or by using a common LFO to apply synchronized changes to multiple modulation effects.

## Effect I/O

### Insert Effects

Insert Effects (IFX 1–5) are stereo-in/stereo-out. If you select Dry (unprocessed) for the “Wet/Dry” parameter, the stereo input signal will be output in stereo without being processed by the effect. If you select Wet (effect applied), the processed signal will be output in one of the following ways:

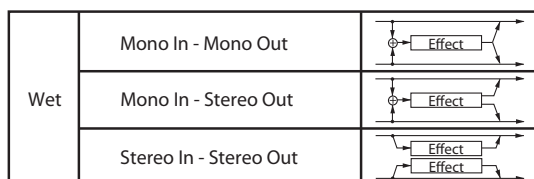

Insert effect 1 can use the effects S01: Stereo Compressor–S63: Rotary Speaker and D00: St.Mltband Limiter–D10: Rotary SpeakerOD.

Insert effects 2–4 can use the effects S01: Stereo Compressor–S61: AmpSim - Tremolo and D00: St.Mltband Limiter–D09: Vocoder.

Insert effect 5 can use the effects S01: Stereo Compressor–S61: AmpSim - Tremolo.

### Master Effects

Master Effects MFX1 and MFX2 are stereo-in/stereo-out. “Send1” and “Send2” determine the send level to the Master Effects.

With Master effects, only the Wet (processed) signal will be output. The output signals from the Master Effects are routed to the L/R bus with the output level specified by “Return1” and “Return2”. These outputs are mixed with the L/R output bus (in each mode, FX ROUTING> BUS page or MIXER page).

Selecting “000: No Effect” will mute the output. The processed signal will be output in one of the following ways, according to the type of effects.

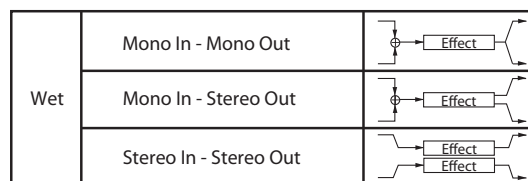

Master effect 1 can use the effects S01: Stereo Compressor–S87: Phaser- Cho/Flng and D00: St.Mltband Limiter–D13: Early Reflections.

Master effect 2 can use the effects S01: Stereo Compressor–S120: Reverb- Gate.

**Note:** The Parameter Guide includes block diagrams for each individual effect, which include the effect's input/output structure. (see page 219 of the Parameter Guide)

## Effects in each mode

### Program mode

For programs, you can use insert effects to process the final sound in the same way that you use the Filter and Amplifier to process the sound from the oscillators (OSC 1 & 2). Then use the master effects to add spatial processing such as reverb to create the final sound. You can also use the same effects on the audio output of the Drum Track and the step sequencer program. These settings are made individually for each program.

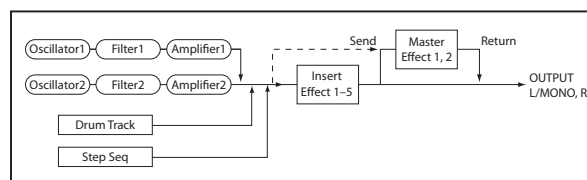

### Combination and Sequencer modes

In Combination and Sequencer modes, you can insert effects to process the sound of each timbre/track program. Then you can use the master effects to create overall ambience, and use the total effect to make final adjustments.

In Combination mode, you can adjust these settings for each combination, and in Sequencer mode you can adjust them for each song.

In Sequencer mode, you can switch between effects or modify the effect parameters and record these changes, so that effects will switch automatically or effect parameters will be modified automatically as the song plays back.

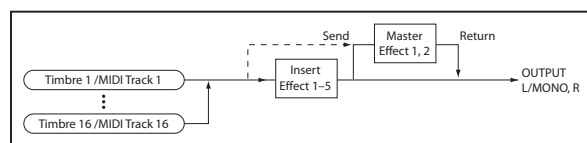

### External input (or audio in)

You can apply effects to an external audio input in any mode: Program, Combination, or Sequencer mode. To specify the effects that you want to use, set the common

input settings of the KROSS in G-SET (Use Global Settings), or use the individual parameters of each mode to specify the BUS or Send settings. (see “Effect settings for audio input” on page 71)

Depending on the type of effects that you’re using on the external audio input, and on their settings, it is possible for feedback to occur. If this occurs, adjust the input/output levels and the effect settings. Take special care when using high-gain effects.

### Audio recorder

The audio recorder can record the sound as it is processed by the effects specified in Program, Combination, or Sequencer mode.

You can’t apply effects to the playback of the audio recorder.

### Pad Sampler, USB Audio

Effects cannot be applied to the playback of the pad sampler, nor to the USB audio input.

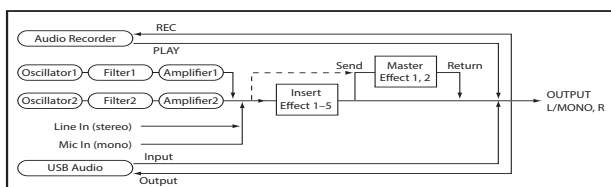

## Routing and effect settings

Routing lets you specify how each sound will be connected to the various effects. In each mode, you can adjust settings for the program’s oscillators, the combination’s timbres, and the song’s tracks.

Here we’ll explain how to adjust routing settings in each mode, and how to edit the effect settings.

## Effect settings for a program

### Routing

1. Access the P-FX ROUTING> BUS page.

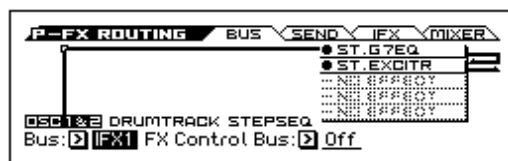

2. “Bus (Bus Select)” specifies the bus where the output from the oscillators will be sent. Here we’ll choose IFX1 so that the output of the oscillators will be sent to insert effect 1.

**L/R:** The oscillator output will not be sent to an insert effect. It will pass through the total effect, and then be sent to OUTPUT L/MONO and R.

**IFX1–IFX5:** The oscillator output will be sent to insert effect 1–5.

**Off:** The oscillator output will not be sent to OUTPUT L/MONO or R, or to insert effects 1–5. Choose this if you want to send the sound directly to the master effects at the send levels specified by Send1 (to MFX1) or Send2 (to MFX2) (P-FX ROUTING> SEND page).

3. If you selected L/R or Off in step 2, you can use each oscillator’s Send1 (to MFX1) and Send2 (to MFX2) parameters to set the send levels to the master effects.

Adjust these settings in the P-FX ROUTING> SEND page.

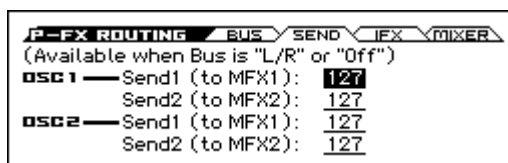

If Bus (Bus Select) is set to IFX1–5, the send levels from the output of each insert effect to the master effects are specified by the S1 (Send1) and S2 (Send2) parameters (P-Fx Routing Mixer page). (see step 6 of the next section, “Insert effects”)

4. “FX Control Bus” sends the output of oscillators 1 and 2 to the FX control bus.

Use this when you want to use a different sound to control the sound that’s being input to an effect. You can use two FX control buses to freely control the sound. (see “FX Control Bus” on page 211 of the Parameter Guide)

## Insert effects

1. Access the P-FX ROUTING> IFX page.

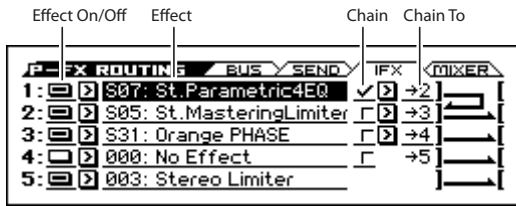

2. In the Effect area, select each insert effect that you want to use.

You can press the ENTER button and choose from a list.

**Tip:** You can use the “Copy Insert Effect” function to copy the effect settings from another effect. The “Swap Insert Effect” function lets you exchange (for example) insert effects 1 and 5.

3. In the Effect On/Off area, turn the insert effect on.

Each time you press the ENTER button, the insert effect will turn on or off. If this is Off, the result will be the same as if 000: No Effect is selected; the input sound will be output without change.

4. Specify the chain setting.

If the **Chain** check box is selected, the insert effect will be chained in series. Set the **Chain To** parameter to “→2.”

If →2 is selected, the insert effects will be connected in series in the order of IFX1 → IFX2.

5. Access the P-FX ROUTING> MIXER page.

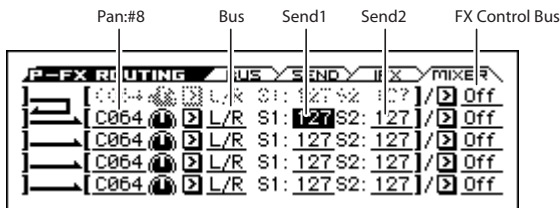

6. Set the “Pan:#8,” “Bus (Bus Select),” “FX Control Bus,” “Send1,” and “Send2” parameters to specify the pan and routing of the signal following the insert effect.

If **Chain** is On, the settings that follow the last insert effect will be used. (**FX Control Bus** is an exception.)

**Pan: #8:** Specifies the pan.

**Bus (Bus Select):** Specifies the output destination. Normally you’ll set this to L/R.

**Send1, Send2:** Specify the send levels to the master effects. For this example, set them to 127.

**FX Control Bus:** The sound that has passed through the insert effect is then sent to the FX control bus. This allows you to use a different sound to control the input to an effect. You can use two FX control buses, giving you a wide range of possibilities for controlling the effects. (see “FX Control Bus” on page 211 of the Parameter Guide)

7. In the P-FX ROUTING> IFX page, edit the parameters of the insert effect you selected.

Edit the parameters in the P-IFX> IFX 1–5 pages.

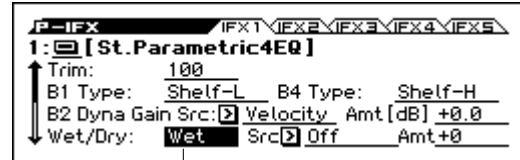
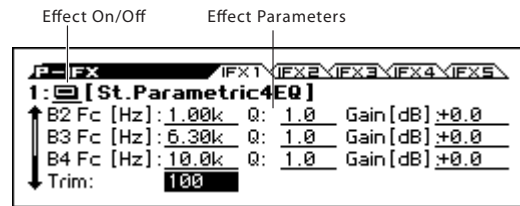

Wet/Dry

**Effect On/Off:** Turns the insert effect on/off. This is linked with the on/off setting of the P-FX ROUTING> IFX page.

For details on the parameters of each effect, please see page 219 and following of the Parameter Guide.

## Double-size effects

Double-size effects (D00: St.Mltband Limiter–D13: Early Reflections) use twice as much processing area as other effects.

D00: St.Mltband Limiter–D10: Rotary SpeakerOD can be used with insert effect 1, D00: St.Mltband Limiter–D09: Vocoder can be used with insert effects 2–4, and D00: St.Mltband Limiter–D13: Early Reflections can be used with master effect 1.

When you use a double-size effect, the next-numbered effect will be unavailable. For example if you’ve selected a double-size effect for IFX1, you won’t be able to use IFX2.

*Example of when a double-size effect is selected for IFX1*

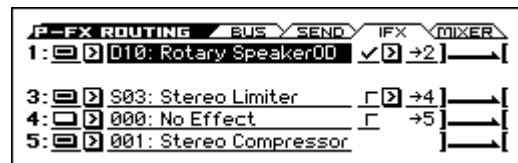

## Master effects

1. “Send1” and “Send2” settings (P-FX ROUTING> SEND page or P-FX ROUTING> MIXER page) determine the input level to the master effects. If “Send1” and “Send2” are set to 0, nothing will be input to the master effects. “Send1” corresponds to MFX1, and “Send2” corresponds to MFX2.

2. Access the P-MFX> SETUP page.



3. For MFX1 and MFX2, select a master effect for each.

The procedure is the same as when selecting an insert effect. (see “Insert effects”)

*Note:* Double-size effects can be selected only for MFX1. (see “Double-size effects”)

4. Press the On/Off button to turn the master effect on.

The master effect will alternate on/off each time you press the button. If it is Off, the output of the master effect will be muted.

5. Use Return1 and Return2 to adjust the output level of the master effects.

*Note:* For each effect’s **Wet/Dry** setting, the Wet value is the output level of that effect. The Dry sound will not be output. This value is multiplied by the return setting (with **Return**= 127 as ×1.0) to determine the actual output level of the master effect.

6. Select the MFX1 or MFX2 page, and edit the effect parameters in each page. (Please see step 7 of “Insert effects”)

## Effect settings for a combination or song

In Combination and Sequencer modes, you can specify how each timbre or track is routed to the insert effects, master effects, and total effects. The procedure for adjusting settings is similar in each mode. Here, we’ll explain the procedure for Combination mode.

### Routing

1. Access the C-FX ROUTING> BUS page.

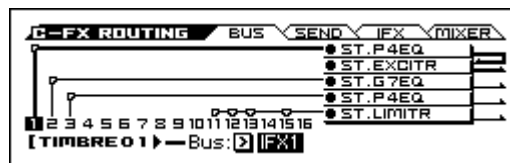

2. Use Bus (Bus Select) to specify the bus where the output of each timbre will be sent. If you want the output of the timbre to be sent to insert effect 1, choose IFX1.

The display shows the routing, the insert effects, and the chain settings. In this example, T01 (timbre 1) is using IFX1 and 2. T02 is using IFX3, T03 is using IFX4, and T11, T12, T13, and T15 are using IFX5.

3. Access the C-FX ROUTING> SEND page.

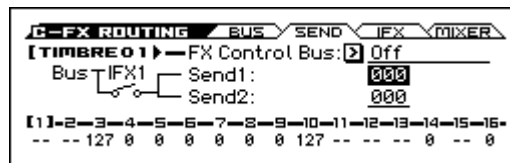

Use Send1 and Send2 to specify the send levels from each timbre to the master effects.

This setting is valid only if **Bus (Bus Select)** is set to L/R or Off.

*Note:* The actual send level is determined by multiplying this setting with the **Send1** or **Send2** value of oscillators 1 and 2 in the program selected by the timbre. If the program’s **S1** (Send1) or **S2** (Send2) setting is 0, the actual level will be 0 even if you raise the send level setting here.

If **Bus (Bus Select)** is set to IFX1–IFX5, the **S1** (Send1) and **S2** (Send2) (C-FX1 ROUTING> MIXER) settings following the insert effect will determine the send levels to the master effects.

4. Access the C-FX ROUTING> MIXER page.

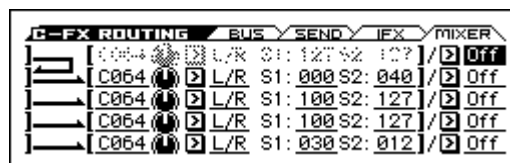

**FX Control Bus** sends the timbre’s output to the FX control bus. Use this when you want to use a different sound to control the input to an effect.

You can use the two FX control buses to control effects with a great deal of flexibility. (see “FX Control Bus” on page 211 of the Parameter Guide)

## Insert effects

1. Access the C-FX ROUTING> IFX page.

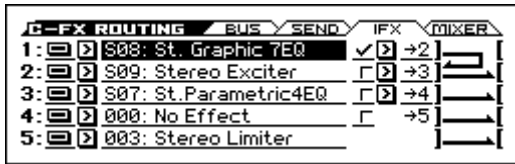

2. Select an insert effect for each IFX1–5, and edit its settings.
3. Access the C-IFX page. Select the IFX1–5 pages, and edit the effect parameters in each page.

You can adjust these settings in the same way as a program. (see page 69)

**MIDI** You can use MIDI to control each effect's dynamic modulation (Dmod) and the "Pan (CC#8)," "Send1," and "Send2" following the insert effect. These settings are controlled on the MIDI channel specified by "Ctrl Ch." For timbres that are routed to an insert effect, a "\*" symbol is shown to the right of the channel number Ch01–16. If multiple timbres with differing MIDI channel settings are routed, you can specify here the channel where control will occur.

## Master effects

You can adjust these settings in the same way as a program. (see page 69)

**MIDI** Dynamic modulation (Dmod) for the master effects and total effect can be controlled on the MIDI channel specified by "Ctrl Ch."

## Effect settings for audio input

You can apply the KROSS's effects to an external audio input from the LINE IN jack or MIC IN jack, and record it on the audio recorder or pad sampler; you can also apply an effect to the mic input or line input along with the program or combination that you're playing. In addition, you can use a vocoder effect (D09: Vocoder) that uses the external mic input to control an internal sound.

Normally, the settings of the Global/Media mode G-INPUT> AUDIO IN page are shared. For special cases, such as when you want to have specific settings for a vocal mic, you can adjust individual settings for a program, combination, or MIDI sequencer song.

## Routing

1. In REALTIME CONTROLS, select AUDIO IN 2 and use the SWITCH button (MIC/LINE) to specify the input jack that you want to enable, either Mic (LED lit) or Line (LED unlit).

If you want to save the edited settings, press "WRITE" (MENU button) in the popup screen that appears when you operate a switch or knob.

2. In REALTIME CONTROLS, select AUDIO IN 1 and use the KNOB 1 knob (GAIN) to adjust the input gain to an appropriate setting.
3. In REALTIME CONTROLS, select AUDIO IN 1 and use the KNOB 2 knob (MFX2/REVERB) to specify the send level to master effect 2.

For preload sounds, either a reverb-type or a delay-type effect is assigned to master effect 2.

4. If you want to access more detailed settings, press the FUNCTION ("QUICK SETTING" ) button in the popup screen that appears when you operate a button or knob in steps 1, 2, or 3.





5. Use Bus (Bus Select) to specify the bus where the audio input will be sent. For example if you want the output of the device that's connected to LINE IN to be input to insert effect 1, specify IFX1 as the Bus (Bus Select) setting when selecting the routing.
6. Use Send1 and Send2 to specify the send levels from the input to the master effects.

These settings are available only if Bus Select is set to L/R or Off.

If Bus Select is set to IFX1–5, the send levels to the master effects are specified by the Send1 and Send2 parameters (in each FX ROUTING> SEND page) for the signal that has passed through the insert effects.

**⚠** Depending on the type of effects that you're using on the external audio input, and on their settings, it is possible for feedback to occur. If this occurs, adjust the input/output levels and the effect settings. Take special care when using high-gain effects.

7. **The Level parameter specifies the level of the external audio signal that's being input. Normally you'll leave this at 127.**
8. **The FX Control Bus sends the audio input to the FX Control bus. Use this when you want to use another sound to control the effect input. You can use two separate FX Control buses to control the effects with a great deal of flexibility. (see "FX Control Bus" on page 211 of the Parameter Guide)**
  -  If you want the edited settings to be saved in the KROSS, be sure to execute the Write function. Do this using the PAGE+ (WRITE G-SET) button in the AUDIO IN -QUICK SETTING- dialog box.
  -  The input gain (Gain) setting will be saved in Global/Media mode. Although you can edit this in the AUDIO IN page or the QUICK SETTING dialog box of each mode, you can't save it individually for a program, etc.
9. **If you want the Input settings of Global/Media mode to be used in the other modes, check G-SET in the "AUDIO IN" page of each mode. If you want to use individual input settings in Program, Combination, and Song modes, clear this check mark.**

## Dynamic modulation (Dmod)

Dynamic modulation (Dmod) lets you use MIDI messages or the KROSS's controllers for realtime control of specific effect parameters.

Another way to control effect parameters is to use MIDI/Tempo Sync, which allows the LFO speed of a modulation effect or the delay time of a delay effect to be synchronized to the tempo of the arpeggiator or sequencer.

(see "Dynamic modulation (Dmod) and Tempo Synchronization" on page 210 of the Parameter Guide)

# Arpeggiator function

## Using the arpeggiator while you play

The arpeggiator is a function that automatically generates arpeggios (patterns of individual notes derived from a chord). Most arpeggiators produce an arpeggio when you play a chord on the keyboard.

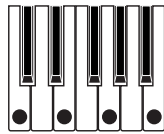

The chord you played on the keyboard is sounded as an arpeggio (broken chord)

The KROSS's arpeggiator is also polyphonic, and can produce a variety of chordal transformations or phrases based on the pitch or timing of the notes you play on the keyboard. These functions let you use the arpeggiator to play a wide range of patterns including drum or bass phrases, and guitar or keyboard backing riffs. It is also effective to use the arpeggiator as part of the sound-design process when creating subtly-moving pads, synth-sounds, or sound effects.

The KROSS's Dual Arpeggiator feature lets you use two simultaneous arpeggio patterns in Combination mode, and Sequencer mode. You can take advantage of this in many ways, including a separate arpeggio pattern for a drum program, and another applied to a bass program, or using a keyboard split or velocity to switch between two arpeggio patterns.

The KROSS provides five preset arpeggio patterns: the standard **UP**, **DOWN**, **ALT1**, **ALT2**, and **RANDOM**. You can also create and store 1,028 of your own user patterns. The factory settings contain a wide variety of arpeggio patterns stored in these user locations. (see page 78)

## Using the arpeggiator in Program mode

### Turning the arpeggiator on/off

1. Press the **PROG** button to enter Program mode, and select a program. For details, please see "Selecting Programs" on page 27.



2. Press **ARP** button (the LED will light up) to turn on the arpeggiator.
3. When you play the keyboard, the selected arpeggio pattern will start playing.
4. Press the **ARP** button once again to turn off the arpeggiator (the button will be unlit).

If it had been playing, it will stop.

**Note:** The on/off status is saved when you write the program.

### Changing the tempo

- In **REALTIME CONTROLS**, select **TEMPO** and use the **KNOB 1** knob (**TEMPO**) or the **SWITCH** button (**TAP**) to adjust the tempo.

The tempo can be adjusted in the range 040.00-300.00. The **SWITCH** button LED blinks at quarter-note (♩) intervals.

**Note:** The tempo setting is also saved when you write a program.

**Note:** The arpeggio playback speed is affected by the **Resolution** (**PROG> ARP** page or **P-ARP> SETUP** page).

**Note:** In the **P-INPUT/CTRL> CONTROLLERS** page you can use the **VALUE** dial or the cursor buttons to edit the setting.

**Tip:** You can synchronize the tempo with an external MIDI device. (see page 117)

 If the KROSS is set to synchronize with an external device, you can't adjust the tempo on the KROSS itself.

### Arpeggiator control (MOD)

You can control the duration, strength, and rhythmic feel of the arpeggiated notes.

1. Access the **PROG> ARP** page.

Use the **PAGE+** button (or **PAGE-** button) to select the page.

2. Use the cursor buttons **◀▶▲▼** to select the following parameters to edit.
3. Use the **VALUE** dial etc. to edit the value.

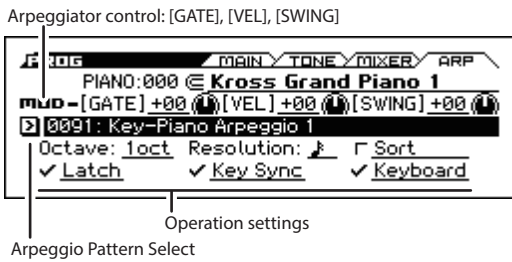

### Changing the length of the arpeggiated notes

- By selecting the arpeggiator control [GATE] and adjusting the value, you can change the duration of the arpeggiated notes.

Negative “-” values make the notes shorter, and positive “+” values lengthen them. If this is 00, the note length will be as specified by the program parameter Gate (P-ARP> SETUP page).

**Note:** It is effective to adjust the Release on the PROG> TONE page.

**Note:** You can also change the duration of the arpeggiated notes by adjusting ARP-GATE (the KNOB 2 knob) in the TEMPO row of REALTIME CONTROLS. (Please see page 308 of the Parameter Guide)

### Changing the strength of the arpeggiated notes

- By selecting the arpeggiator control [VEL] (Velocity) and adjusting the value, you can change the strength of the arpeggiated notes.

Negative “-” values make the notes weaker, and positive “+” values strengthen them. If this is 00, the strength of the notes will be as specified by the program parameter Velocity (P-ARP> SETUP page).

**Note:** It is effective to adjust Cutoff, Resonance, and EG Intensity in the PROG> TONE page.

### Giving a shuffle feel to the arpeggio pattern

- By selecting the arpeggiator control [SWING] and adjusting the value, you can shift the timing of the even-numbered arpeggiated notes forward or backward.

Negative “-” settings will make the even-numbered notes earlier; positive “+” settings will make them later. If this is at the center position (12 o’clock), the setting will be as specified by the program parameter Swing (P-ARP> SETUP page).

**Note:** Swing has no effect on the preset patterns.

## Arpeggio pattern selection and operation settings

In the PROG> ARP page you can select an arpeggio pattern and specify how the arpeggiator will function.

- Access the PROG> ARP page.
- Use the cursor buttons ◀▶▲▼ to select the following parameters to edit.
- Use the VALUE dial etc. to edit the value. Press the ENTER button to switch the setting of the check box.

### Selecting an arpeggio pattern

- In the Arpeggio Pattern Select area, select an arpeggio pattern.

Preset: UP—Preset: Choose an arpeggio pattern from RANDOM or 0000–1023.

With the factory settings, a variety of arpeggio patterns are provided in the range 0000–1023.

#### Preset: UP



#### Preset: DOWN



#### Preset: ALT1



#### Preset: ALT2



#### Preset: RANDOM



### Playing arpeggios across multiple octaves

- Use the Octave setting to specify the range of 1–4 octaves in which the arpeggio will be generated.

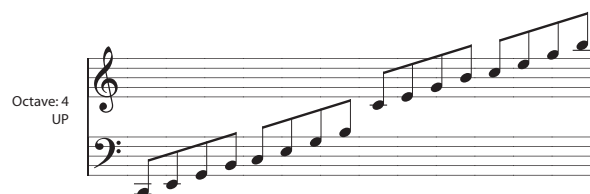



## Changing the note value of the arpeggiated notes

- The **Resolution** parameter lets you set the note value of the arpeggiated notes, over a range from  $\text{♩}_3$ – $\text{♩}$ .

## Sounding an arpeggio in the order of the pitches in the chord you played

- The **Sort** parameter lets you select whether the notes of the arpeggio will be sounded in the order of the pitches in the chord you played (regardless of the order in which you actually played the notes), or in the order that you played the notes.

**Checked:** the arpeggio will play each note in the order of its pitch, regardless of the order that you actually played the notes.

**Unchecked:** the arpeggio will trigger each note in the order that you actually played the notes.



## Setting the arpeggio to continue playing even after you have taken your hand off the keyboard

- The **Latch** parameter lets you select whether the arpeggio will continue playing when you take your hand off the keyboard, or whether the arpeggio will stop.

**Checked:** The arpeggio will continue playing even after you remove your hand from the keyboard.

**Unchecked:** The arpeggio will stop playing when you remove your hand from the keyboard.

## Synchronizing the arpeggiator to your keyboard timing

- The **Key Sync** parameter lets you specify whether the arpeggio will begin at the moment you play the keyboard, or whether it will always play in synchronization to the MIDI clock tempo.

**Checked:** The arpeggio pattern will start from the beginning when you press a key. This setting is suitable when you want the arpeggio to start from the beginning of the measure as you are playing in realtime.

**Unchecked:** The arpeggiator will synchronize to the MIDI clock timing.

## Sounding both the arpeggio notes and the notes you play

- The **Keyboard** parameter lets you specify whether the notes that you play on the keyboard will be sounded along with the arpeggiated notes.

**Checked:** The notes you play on the keyboard and the notes played by the arpeggiator will both be heard.

**Unchecked:** Only the arpeggiated notes will sound.

## Specifying the zone where the arpeggiator will function

In P-ARP> SCAN ZONE page you can specify the range of notes (keys) and velocities where the arpeggiator will function.



## Using the arpeggiator in Combination mode

In Combination mode the KROSS provides dual arpeggiators, allowing you to run two arpeggio patterns simultaneously.

- In Combination mode, select a combination. (see “Selecting Combinations” on page 45)**
- Each time you press the ARP button, the arpeggiator will turn on or off.**

*Tip:* As you select various combinations, you’ll notice that the ARP button LED will light up for some combinations. (see “Linking the arpeggiator to programs or combinations” on page 77)
- If the arpeggiator is on, an arpeggio will start playing when you play the keyboard.**
  - In some combinations or songs, depending on the arpeggiator A and B settings, the arpeggiator might not start even if you turn on the ARP and play the keyboard. (see page 77)
- In REALTIME CONTROLS, select TEMPO and use the KNOB 1 knob (TEMPO) or the SWITCH button (TAP) to adjust the tempo.**
  - The ARP button and the KNOB 1 (TEMPO) knob and SWITCH (TAP) button in the TEMPO row of REALTIME CONTROLS apply to both arpeggiators A and B. Their state is saved when the combination is written.

## Selecting an arpeggio pattern and adjusting settings

You can select an arpeggio pattern and specify how the arpeggiator will function.

- Access the COMBI> ARP page.**

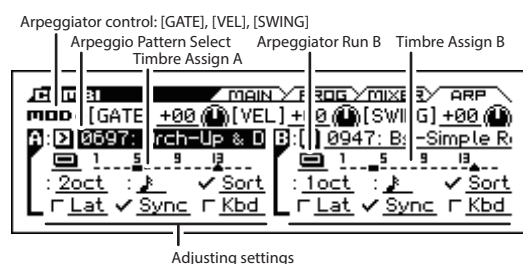

- Notice how the arpeggio changes as described in “Arpeggiator control (MOD)” on page 73, and “Arpeggio pattern selection and operation settings” on page 74.**

### Select the arpeggiator(s) that will run

Use the Arpeggiator Run setting to enable the arpeggiator(s) that you want to use. The arpeggiator(s) that this is on will run when the ARP button is on.

However, the arpeggiator will only play a timbre if the table next to the check boxes assigns arpeggiator A or B to a timbre: T 1–16. You change these settings in C-ARP> ASSIGN page **Arpeggiator Assign**. (see page 76)

### Arpeggiator-A, Arpeggiator-B

For each arpeggiator A and B, you can adjust settings for **Pattern Select**, **Resolution**, **Octave**, **Sort**, **Latch**, **Key Sync**, and **Keyboard**. (see page 74)

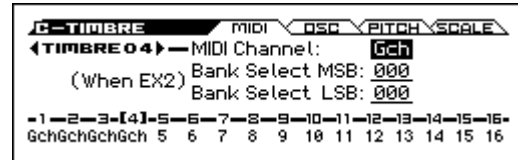

3. Access the C-ARP> ASSIGN page.

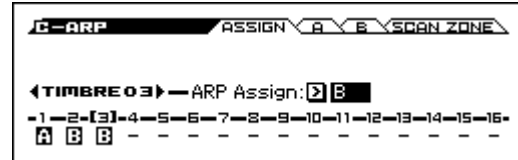

4. Set “Temp” to specify the tempo.

This is the same as for a program. However, the tempo is shared by both arpeggiators A and B.

5. Adjust “ARP Assign” settings.

Assign arpeggiator A or B to the desired timbres. Each timbre will be played by the arpeggiator that has been assigned to it.

6. In the C-ARP> A, B pages, set the Run (Arpeggiator Run) parameter.

Turn this on for the arpeggiator(s) that you want to use. The arpeggiator(s) checked here will run when the ARP button is turned on.

With the settings shown in the display for steps 2 and 3, turning the ARP button on will cause arpeggiator A to run for timbre 1, and arpeggiator B to run for timbres 2 and 3. When the ARP button is turned off, timbres 1–4 will sound as a layer.

If all timbres ARP Assign status are set to **Off**, or if **Run** (Arpeggiator Run) is **unchecked**, the arpeggiator will not function.

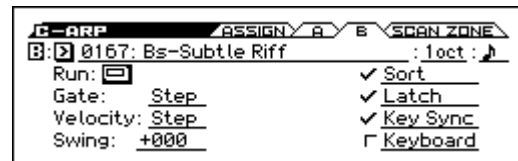
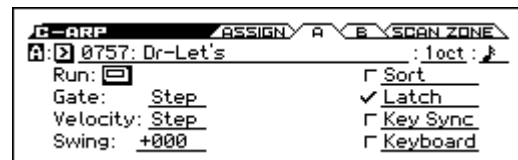

7. On the C-ARP> A, B pages, set the parameters for arpeggiators A and B.

The parameters for A and B are the same as for a program. (see page 74)

8. In the Scan Zone A/B page, specify the range in which arpeggiators A and B will function.

The parameters for A and B are the same as for a program.

You can use keyboard ranges or velocity ranges to use one or both of the arpeggiators, or to switch between arpeggiators A and B. By using the C-ZONE/DELAY> KEY\_ZONE, and VEL\_ZONE page to set keyboard and velocity ranges in conjunction with each other, you can create even more variations.

9. If you wish to save the edited combination settings in internal memory, turn off memory protect in Global/

## Arpeggiator settings in Combination and Sequencer modes

In Combination and Sequencer modes, you can use two arpeggio patterns simultaneously, thanks to the KROSS’s dual arpeggiator functionality. The settings in each of these modes are adjusted in a similar way.

The following example shows how to adjust settings in Combination mode.

The dual arpeggiator functionality lets you do the following things.

- Assign an arpeggiator for each timbre. Choose from **Off**, (arpeggiator) **A**, or (arpeggiator) **B**. →step 5
- Independently specify whether **A** and **B** will run. →step 6
- Select an arpeggio pattern and set parameters independently for **A** and **B**. →step 7
- Select Scan Zone page settings so that you can use the keyboard range or playing velocity to switch between normal playing and arpeggiated playing, or to switch between arpeggiators **A** and **B**. →step 8
- Adjust settings for timbres that will be silent when the arpeggiator is Off, and will sound only when the arpeggiator is On. →step 10

### Arpeggiator settings

1. Select COMBI> PROG page.

Select programs for the timbres that you wish to use. For this example, select any desired program for timbres 1–4.

For the timbres that you want to use, set their Status to INT. For this example, set Status to INT for timbres 1–4, and Off for timbres 5–16.



2. Access the C-TIMBRE> MIDI page.

Set the MIDI Channel to match the Gch or global MIDI channel (set in G-MIDI> BASIC page MIDI Channel).

For timbres 1–4, set MIDI Channel to Gch.

Media mode, and write the combination. (see pages 116, 122)

10. The “Status,” “MIDI Channel” and “Arp Assign” settings shown in the display of steps 1 to 3 can be adjusted so that certain timbres will sound only when the arpeggiator is On, and will be silent when the arpeggiator is Off.

### Combination PIANO: 032 Piano Trio

Although this is a somewhat sophisticated editing technique, we will describe the settings of one of the preset combinations as an example.

When you play a specific region of the keyboard, this combines settings that cause the arpeggiator to play an arpeggio using different sounds than what’s being played by the keyboard, with other settings that cause the arpeggiator sounds to remain completely unplayed when the arpeggiator is off.

Before you play, make sure that the global MIDI channel (G-MIDI> BASIC MIDI Channel) is set to 01.

Select combination PIANO: 032 Piano Trio, turn the ARP button on, and play. To make the arpeggiator performance more clearly audible, turn off the DRUM TRACK button.

- Arpeggiator A is assigned to timbres 2, 3 and 14 (COMBI> ARP page). When you play the keyboard, the bass riff arpeggio pattern will sound timbres 2 and 3.
- The A **Bottom Key** and **Top Key** (C-ARP> SCAN ZONE page) are set so that arpeggiator A will function only for notes C4 and lower.
- Arpeggiator A is also assigned to timbre 14, but this is so that the timbres 2 and 3 program will sound only when the arpeggiator is on.

Notice the timbre settings for timbres 2, 3 and 14.

Timbre	Status	MIDI Channel	Assign
2, 3	INT	02	A
14	Off	Gch	A

- If the arpeggiator is off, playing the keyboard will sound the timbre(s) that are set to Gch or to the global MIDI channel (in this case, 01). Since the **MIDI Channel** of timbres 2 and 3 is set to 02, it will not sound. Timbre 14 is set to Gch, but since the “Status” is Off it will not sound.
- Notes from any MIDI channels that are assigned to a timbre will trigger the arpeggiator. In this case, these will be **MIDI Channel** 02 and Gch (global MIDI channel). When the arpeggiator is on, playing the keyboard will trigger arpeggiator A, which is assigned to timbre 14 (Gch). Timbres 2 and 3 will be sounded by arpeggiator A. Since the **Status** of timbre 14 is Off, it will not sound.
- Since the **Status** of timbre 14 is Off, it will not sound, regardless of whether the arpeggiator is on or off. It is a dummy timbre that causes timbres 2 and 3 to sound only when the arpeggiator is on.

### Combination BASS: 035 Jazzy Guitar

Before you play, make sure that the global MIDI channel (G-MIDI> BASIC MIDI Channel) is set to 01.

Select combination BASS: 035 Jazzy Guitar, turn the ARP button on, and play.

- Arpeggiator A is assigned to timbres 6, 7, 8, and 14, and arpeggiator B is assigned to timbres 4, 5, and 9. When you press any note of the entire keyboard, the drum programs of timbres 6–8 will be sounded by the arpeggio pattern of arpeggiator A. When you play the keyboard below B3, you’ll hear a bass line arpeggio play bass programs sounded by timbres 4, 5, and 9.
- The arpeggiator A parameters “Bottom Key” and “Top Key” (C-ARP> SCAN ZONE page) are set so that arpeggiator A will run for the entire keyboard.
- The B **Bottom Key** and **Top Key** (C-ARP> SCAN ZONE page) are set so that arpeggiators B will function only for the note B3 and below.
- Arpeggiator A is assigned to timbre 14 as well, but this setting is so that timbres 6 to 8 will sound only when the arpeggiator is on. Please see the preceding section “Combination PIANO: 032 Piano Trio.”

## Linking the arpeggiator to programs or combinations

You can specify whether the arpeggiator settings that are written to a program or combination will be recalled when you switch programs or combinations, or whether the current arpeggiator settings will be maintained.

With the factory settings, the former is selected. Use the latter when you want to keep the same arpeggio pattern running, and change only the program sound.

This setting is made in “LOAD ARP WHEN CHANGING (GLOBAL> SYSTM page). (see page 116)

## Creating a user arpeggio pattern

### About user arpeggio patterns

The patterns that can be selected on the KROSS's arpeggiator are called "arpeggio patterns." There are two types of arpeggio patterns: preset arpeggio patterns and user arpeggio patterns.

#### Preset arpeggio patterns:

There are five patterns; UP, DOWN, ALT1, ALT2, and RANDOM.

The functionality of these patterns is fixed, and cannot be edited.

#### User arpeggio patterns:

There are 1280 patterns - 0000–1279 - which can develop chords or phrases in a wide variety of ways, based on the pitches that you play on the keyboard or the timing with which you play them.

In Global ARP PATTERN, Setup you can modify these user arpeggio patterns, or create a new user arpeggio pattern from an initialized condition. Edited user arpeggio patterns can be written to internal memory areas 0000–1279. (see page 124)

In Media mode, you can also save user arpeggio patterns to media.

### Editing a user arpeggio pattern

If you want to edit a user arpeggio pattern, you must first make sure that memory protect is unchecked. (see page 116)

If you enter this mode from the Program mode, your editing will apply to the arpeggio pattern that's specified for the selected program.

1. In Program mode, select a program which uses the arpeggio pattern that you wish to edit, or a program that you wish to use as a basis for editing the arpeggio pattern.

2. Press the ARP button to turn the arpeggiator on (the button will light up).

*Tip:* Even if you entered Global/Media mode from a program in which the arpeggiator was turned off, you can use the ARP button to turn it on.

3. Select the Global ARP PATTERN> SETUP page.

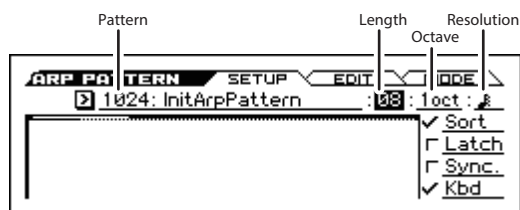

*Note:* If you move from Program mode, arpeggiator "A" will be automatically selected.

4. In "Pattern," select the arpeggio pattern that you wish to edit.

If a blank pattern is selected, playing the keyboard will not start an arpeggio. Although preset arpeggio patterns can be selected, they cannot be edited.

When you edit a user arpeggio pattern, the changes will have an effect anytime that this pattern is used in Program, Combination, or Song.

5. In "Length," specify the length of the pattern.

After the pattern has played for the length specified, it will return to the beginning. This setting can also be changed during or after editing. For this example, set it to 08.

*Note:* For the preload arpeggio patterns 0000–1023, simply changing the "Length" can significantly change the character of the pattern. Try changing the length and listening to the result.

6. Adjust settings for the "Resolution," "Octave," "Sort," "Latch," "(Key) Sync.," and "Kbd (Keyboard)" parameters.

These are program parameters, but they can be set from here as well.

If after accessing this page from Program mode, you modify these parameters and wish to keep your changes, return to Program mode and write the program. These parameters are not saved by "Write Arpeggio Pattern."

For this example, select the settings shown in step 3.

7. In ARP PATTERN> MODE page, specify how the arpeggio will be developed.

8. Access the ARP PATTERN> EDIT page.

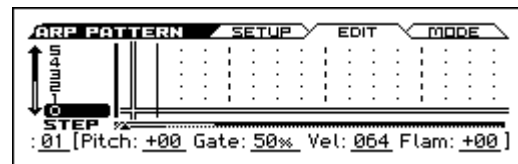

A pattern consists of Steps and Tones.

• **Step:** Each user arpeggio pattern has up to 64 steps. Starting with the first step, the arpeggiator will play notes at intervals of the note value specified by the Resolution. The vertical lines of the grid indicate the steps.

• **Tone:** Each step can sound a chord of up to 12 tones (Tone No. 00–11).

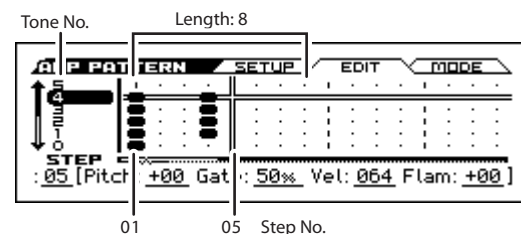

9. Enter one or more Tones at each Step. Use the cursor buttons ◀▶▲▼ to select the Step, and press the ENTER button. The tone will alternate on/off each time you press the button. In the illustration above, Tone No.:04 and Step No.:05 are indicated.

10. Use Step to select the step; then specify the Pitch (Pitch Offset), Gate, Vel (Velocity) and Flam for each step. (Please see step 3 of "An example of creating a pattern")

## An example of creating a pattern

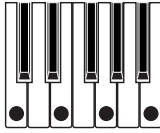

1. Access the ARP PATTERN> EDIT page.
2. Enter the tones shown in the following illustration.

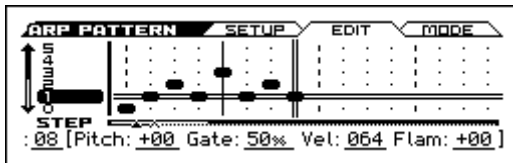

3. When you play the keyboard as shown in the illustration, the arpeggiator will begin playing.  
Tone 0 corresponds to the pitch of the lowest key of the chord you play on the keyboard. (If Sort is unchecked, it will correspond to the pitch of the first note you play.)

4. For steps 01–08, adjust settings for “Pitch (Pitch Offset),” “Gate,” “Vel (Velocity),” and “Flam.”  
**Pitch (Pitch Offset):** This offsets the pitch of the arpeggio note in semitones up or down. You can input the same tone for each step, and change the **Pitch Offset** value for each to create a melody using a single tone. (see “Melody pattern”)

**Gate:** Specifies the length of the arpeggio note for each step. With a setting of LGT (Legato), the note will continue sounding either until the next note of the same tone or until the end of the pattern. With a setting of Off, the note will not sound.

**Vel (Velocity):** This specifies the strength of the note. With a setting of Key, the note will sound at the strength of how it was actually played.

- 2 The **Gate** and **Velocity** settings you select here will be valid if the **Gate** and **Velocity** parameters (P-ARP> SETUP page) of the program that was selected in Program mode are set to Step. If these parameters have a setting other than Step, the **Gate** and **Velocity** settings that were specified for each individual step will be ignored, and all notes of the arpeggio will sound according to the settings in P-ARP> SETUP page. Be sure to verify the settings of the program.

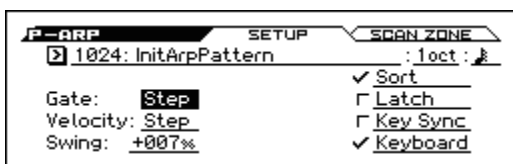

- 2 When specifying Gate, Velocity, and Swing, set the PROG> ARP page parameters [GATE], [VEL], and [SWING] to +00.



5. To rename the user arpeggio pattern, use the Rename Arpeggio Pattern function. (“Rename Arpeggio Pattern” on page 179 of the Parameter Guide)
6. Be sure to execute the Write operation if you want the edited user arpeggio pattern to be saved in internal memory. (→ p.124)  
If you turn off the power without writing, the edited content is lost.
7. If you want to save the state of the program at the same time, return to program mode and write the program. (→ p.122)

## Melody pattern

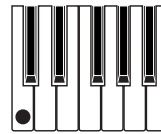

1. Access the ARP PATTERN> EDIT page.
2. Specify tone 0 for Step 01, 02, 03, 04, 05, 07, 08 (all other than 06).
3. Specify the pitch. Set the “Step” 02 “Pitch” to +10, “Step” 05 “Pitch” to +12, and the “Step” 08 “Pitch” to -2.

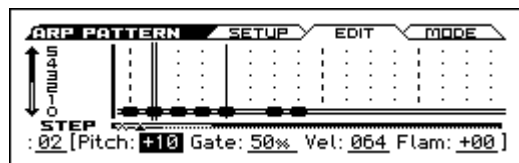

4. Play a single key; the arpeggio will begin playing.

## Chordal pattern

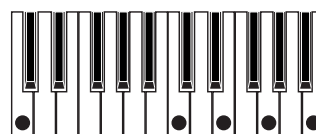

1. Access the ARP PATTERN> EDIT page.
2. In Step 01, set tone 01.
3. In “Step” 03, 04, 06, and 08, set tones 00–04.
4. Select “Step” 01, and set “Gate” to LGT (Legato).

5. Select “Step” 06, and set “Gate” to LGT (Legato).

**Tip:** To simulate the timing nuances of a strummed guitar chord, select **Flam**. In Program mode, select an acoustic guitar program, and choose the user arpeggio pattern that you created here. In the P-ARP> SETUP page, set **Gate** to Step.

Then return to the ARP PATTERN> EDIT page. For odd-numbered steps, set **Flam** to a positive (+) value. For even-numbered steps, set **Flam** to a negative (-) value.

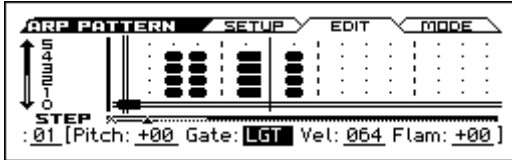

ENTER button once again and then press the EXIT button.

4. Access the ARP PATTERN> EDIT page.

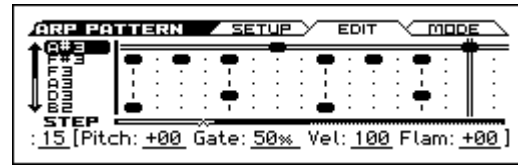

Let's input the following rhythm pattern.

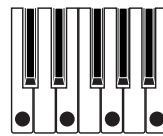
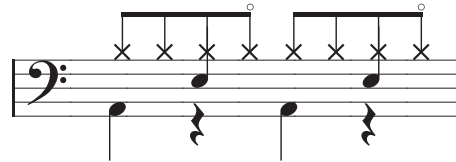

### Drum pattern

You can use the arpeggiator to play a rhythm pattern by using “Fixed Note” with a drum program.

1. In Program mode, select a drum kit program.

For this example, select the preset program DRUMS/ SFX: 000 Basic Kit 1.

2. In ARP PATTERN, select the MODE page, and parameter settings.

**(Arpeggio) Tone Mode:** Set this to Fixed Note. This will cause the tone to always sound at the specified pitch.

**Mode (Fixed Note Mode):** If you set this to Trigger All Tones, playing a single note on the keyboard will sound all tones.

If you set this to **Trigger As Played**, the tones will be sounded according to the notes that you play on the keyboard. (see page 169 of the Parameter Guide)



3. For each “Tone,” specify “Fixed Note No.”

Access the FIXED Setup dialog box. Here you can assign a different drumsample (note number) of the drum kit to each fixed note.

For this example, set **Tone No.** and **Fixed Note No.** as follows.

Tone No.	Fixed Note No.
0	B2 (kick)
1	D3 (snare)
4	F#3 (closed hi-hat)
5	A#3 (open hi-hat)

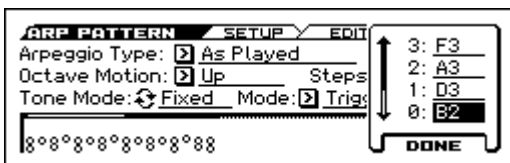

The drumsample corresponding to each note number will differ depending on the drum kit. It's convenient to use the keyboard to audition the drum sounds, select Fixed Note No. and press the ENTER button, and then press a key to enter the note number. To confirm, press the

5. Enter the kick (Tone00).

Set tone 00 (B2) of Step 01 and 09.

6. Enter the snare (Tone01).

Set tone 01 (D3) of Step 05 and 13.

7. Enter the closed hi-hat (Tone04).

Set tone 04 (F#3) of Step 01, 03, 05, 09, 11, and 13.

8. Enter the open hi-hat (Tone05).

Set tone 05 (A#3) for Step 07 and 15.

9. If “Mode (Fixed Note Mode)” is set to Trigger All Tones, playing a single note on the keyboard will cause the rhythm pattern to play.

Playing two notes on the keyboard will cause only the kick (Tone00) and snare (Tone01) to play. In this way, the number of keys that you play will be played by the same number of tones.

10. Set the parameters for each step.

Use **Vel (Velocity)** etc. to add accents to the rhythm pattern.

⚠ The **Gate** and **Vel (Velocity)** settings you select here will be valid if the **Gate** and **Velocity** parameters (P-ARP> SETUP page) of the program selected in Program mode are set to Step. If these parameters have a setting other than Step, the **Gate** and **Velocity** that were specified for each individual step will be ignored, and the notes of the arpeggio will be sounded according to the settings of the P-ARP> SETUP page. Check the settings of the program.

⚠ When specifying Gate, Velocity, and Swing, set the PROG> ARP page parameters [GATE], [VEL], and [SWING] to +00.

---

## Dual arpeggiator editing

Here we will use a combination as an example in our explanation.

The same procedure applies when editing an arpeggio pattern in Sequencer mode.

If you have entered this mode from the Combination mode, the arpeggio pattern selected by the combination will be affected by your editing.

**1. In Combination mode, select a combination that uses the arpeggio pattern that you wish to edit.**

For this example, select a combination where both arpeggiators A and B are assigned.

**2. Press the ARP button to turn on the arpeggiator (the button will light up).**

Even if the arpeggiator had been turned off when you moved here, you can use the ARP button to turn it on. However, if **Arpeggiator Run A** or **B** are not checked, and if **Arpeggiator Assign**, is set to off, then the arpeggiator will not function.

**3. Select the ARP PATTERN> SETUP page.**

**4. Press the ENTER button at Arpeggio Select A or B to specify the arpeggiator that you want to edit.**

If this is A, your editing will apply to the parameters and user arpeggio pattern of arpeggiator A.

If this is B, your editing will apply to the parameters and user arpeggio pattern of arpeggiator B.

**5. Switch between arpeggiators A and B, and edit their respective user arpeggio patterns.**

If you want to stop one of the arpeggiators, return to Combination mode, access the COMBI> ARP page and turn Arpeggiator Run off.

**6. To modify the name of a user arpeggio pattern, use the “Rename Arpeggio Pattern” function. (see page 179 of the Parameter Guide)**

**7. If you wish to save the edited user arpeggio pattern in internal memory, you must write the user arpeggio pattern.**

In this case, both user arpeggio patterns will be written simultaneously. If you turn off the power without writing, the edited contents will be lost.

**8. If you wish to save the state of the combination at the same time, return to Combination mode and write the combination. (see page 122)**

*Note:* When editing a user arpeggio pattern, pay attention to the global MIDI channel, the channel of each track, and the arpeggiator assignments, and make sure that the arpeggiator you are hearing is the pattern that you wish to edit.

---

## Regarding arpeggiator synchronization

---

### “Key Sync.” parameter

The timing of the arpeggiator notes depends on the state of the arpeggiator **Key Sync.** check box.

If this box is checked, the arpeggiator will start running at the first note-on that occurs after you’ve taken your hands completely off the keyboard.

If this box is unchecked, the arpeggiator will run in synchronization with the internal/external MIDI clock.

Below, we will explain how synchronization occurs when the **Key Sync.** check box is not checked (Synchronization with Song Start and with MIDI realtime Start messages are excluded).

---

### Synchronization between arpeggiators A and B

In Combination and Sequencer modes, the two arpeggiators can run simultaneously. In this case, if one arpeggiator is already running, and you then run the other arpeggiator (with “Key Sync.” unchecked), the second arpeggiator will synchronize to the “♪(Tempo)” based on the first arpeggiator.

If **Key Sync.** is checked, arpeggiators A and B will run independently, each at their own tempo.

---

### Synchronization with the drum track

If you want the arpeggiator to synchronize to the drum track pattern that’s currently playing, uncheck the **Key Sync.** setting. In this case, the arpeggiator will synchronize to the beat of the drum track pattern that’s currently playing.

*Note:* If you want the drum track pattern to synchronize to the arpeggiator that’s currently running, turn on the “Sync” setting (the Trigger parameter of the DRUM TRACK> PATTERN page of each mode).

---

### Synchronizing with the step sequencer

If you want the arpeggiator to synchronize with the loop pattern being played by the step sequencer, clear the Key Sync check box. In this case, the arpeggiator will synchronize with the beat based on the loop pattern that’s currently playing.

---

### Synchronization between the arpeggiator and sequencer in Sequencer mode

#### If song playback is stopped

- The arpeggiator will synchronize to the “♪(Tempo)” based on the internal MIDI clock timing.

#### While playing back or recording a song

- The arpeggiator will synchronize to the beat based on the timing of the song.

### Synchronization with Song Start

- If the arpeggiator is turned on (ARP button is on) and is running, it will reset to the beginning of its arpeggio pattern when a Song Start message is received. (This is unaffected by the **Key Sync.** setting.)
- In Sequencer mode when **Key Sync.** is unchecked and the ARP button is on, if you start the arpeggiator by pressing a key during the pre-count before recording begins, the arpeggiator will start its pattern as soon as recording begins, and will be recorded.

---

### Synchronization with external sequencer playback

If “♩ (Tempo)” is EXT (i.e., if G-MIDI > BASIC MIDI Clock is External MIDI or External USB) in Program, Combination, or Sequencer modes, the arpeggiator will synchronize to the MIDI timing Clock and Start messages received from a connected MIDI device.

*Note:* Synchronization will occur in the same way if the **MIDI Clock** is set to Auto and MIDI timing clock messages are being received from a connected MIDI device.

### Synchronization with external MIDI timing clock

The arpeggiator will synchronize to the “♩ (Tempo)” timing of the external MIDI timing clock.

### Synchronization with MIDI realtime Start messages

If the arpeggiator is turned on and running, an incoming MIDI realtime Start message will reset the arpeggiator to the beginning of its pattern (This is unaffected by the **Key Sync.** setting).



# Drum Track function

## Performing with the Drum Track function

The Drum Track function makes it easy to play the KROSS's high-quality drum programs using a wide variety of Drum Track patterns.

It provides a convenient way for you to hear Drum Track patterns while you try out various phrases on a program or combination, or work out the outline of your song. Then, when you've come up with some ideas, you can use the Auto Song Setup function to immediately start recording in Sequencer mode.

You can use preset drum patterns that cover a wide range of musical styles.

Preset	001...772	Preset Drum Track patterns
--------	-----------	----------------------------

The Drum Track pattern will start immediately when you press the DRUM TRACK button, or when you play the keyboard after pressing the DRUM TRACK button. If you're starting the pattern by playing the keyboard, you have the option of starting it by using a specific range of notes or velocities.

The Drum Track can also play in synchronization with the arpeggiator.

In Program mode, the drum track has a dedicated mixer channel and effect routing, allowing you to control the drum track independently from the sound of the program itself. In Combination and Sequencer modes, the drum track is handled as a conventional timbre or track, allowing you to select programs, and specify the effect routing in the same way as for conventional timbres or tracks.

## Using the Drum Track function in Program mode

### Playing and stopping the Drum Track

1. In Program mode, select a program. (see "Selecting Programs" on page 27)



2. Press the DRUM TRACK button to turn the Drum Track on.

The DRUM TRACK button will light up or blink, depending on the setting (**Trigger Mode**) of the program.

If lit: The Drum Track pattern will start according to the **Sync** setting. When you turn it off, the pattern will stop. (This will occur if the **Trigger Mode** parameter is set to Start Immediately.)

If blinking: The Drum Track pattern will be ready to start. It will start when you play the keyboard or when a MIDI note-on message is received. (This will occur if the **Trigger Mode** parameter is set to Wait KBD Trigger.)

3. Press the DRUM TRACK button once again to stop the Drum Track (the button will be unlit).

## Changing the tempo

- Use the TEMPO controls of REALTIME CONTROLS to adjust the tempo of the KROSS. (→ p.15)

## Selecting the Drum Track pattern and Drum Track program

1. In the Program mode page P-DRUM TRACK>PATTERN, use Pattern No. to select a drum track pattern.

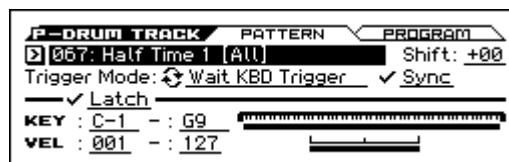

2. In the P-DRUM TRACK> PROGRAM page, the Drum Track Program parameter selects the program that will play the Drum Track patterns.



*Note:* You can only select programs from the DRUM/SFX category.

*Note:* If you've selected an empty pattern, the DRUM TRACK button will not function.

## Setting the volume, mute, and solo for the drum track pattern

In the PROG> MIXER page you can edit the volume, mute, and solo settings. (see page 32)

## Using the Drum Track function in Combination mode

5. Press the DRUM TRACK button to verify that the pattern plays correctly.

The method of triggering will depend on the Trigger settings.

### Selecting a combination and turning the Drum Track function on/off

1. Press the COMBI button to enter Combination mode, and select the desired combination. (see “Selecting Combinations” on page 45)
2. Press the DRUM TRACK button to turn the Drum Track on/off. For details, please see the Program mode sections “Playing and stopping the Drum Track”, and “Changing the tempo”.

### Selecting a Drum Track pattern and Drum Track program

Unlike its functionality in Program mode, the Drum Track function in Combination mode does not have its own dedicated track (timbre). The program that plays the Drum Track pattern will use the timbre that you specify.

1. In the COMBI> PROG page, select the timbre that you want to use for the drum track, and then select the Drum Track program.

In the following illustration, we’ve selected timbre 5 for use by the drum track.



2. In the C-TIMBRE>MIDI page, specify the MIDI channel of the timbre used by the drum track.

Be aware that if another timbre uses the same MIDI channel, that timbre will also be played.

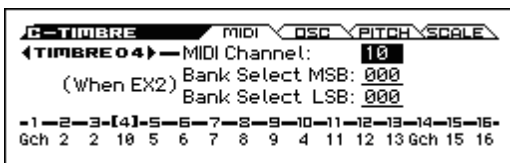

3. In the C-DRUM TRACK>CHANNEL page, use Output to specify the output MIDI channel for the drum track.

Specify the drum track’s MIDI channel **Output**. Set this to match the **MIDI Channel** of the timbre that you specified in step 2.

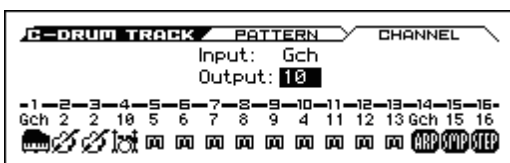

4. Access the C-DRUM TRACK> PATTERN page.

Use Pattern No. to select the Drum Track pattern.

**Note:** 000: If you select Off, it will not be possible to turn the DRUM TRACK button on.

# Drum Track function settings

## Drum Track function settings in Program mode

### Starting/stopping the drum track

1. Access the Program Mode P-DRUM TRACK>PATTERN page.



2. “Trigger Mode” specifies how the Drum Track pattern will be triggered.

**Start Immediately:** When you press the DRUM TRACK button to turn it on, the LED will light up and the Drum Track pattern will start according to the **Sync** setting. It will stop when you press the DRUM TRACK button to turn it off.

**Wait KBD Trigger:** When you press the DRUM TRACK button to turn it on, the LED will blink and the Drum Track pattern will wait to start. When you play the keyboard or receive a MIDI note-on, the Drum Track pattern will start according to the **Sync** setting.

3. Specify the Sync setting.

**Off (unchecked):** The Drum Track pattern will not synchronize to the arpeggiator that’s currently running, but will start immediately.

**On (checked):** The Drum Track pattern will synchronize to the arpeggiator that’s currently running.

4. If “Trigger Mode” is set to Wait KBD Trigger, specify the “Latch” setting. “Latch” specifies whether the Drum Track pattern will continue playing even after you take your hand off the keyboard.

**Off (unchecked):** If the DRUM TRACK button is on (the LED will blink), the pattern will start when you play the keyboard (note-on). The pattern will stop when you release the keyboard (note-off).

**On (checked):** If the DRUM TRACK button is on (the LED will blink), the pattern will start when you play the keyboard (note-on). The pattern will continue when you release the keyboard (note-off). The pattern will stop when you turn the DRUM TRACK button off (the LED will go dark).

5. If “Trigger Mode” is set to Wait KBD Trigger, specify the Keyboard Zone and Velocity Zone.

These settings specify the range of keys and velocities that will trigger the Drum Track pattern when you play the keyboard (or receive a note-on).

### Saving the on/off status

If “Trigger Mode” is set to Wait KBD Trigger, the drum track’s on/off status can be saved in the program.

If “Trigger Mode” is set to Start Immediately, the drum track’s on/off status will always be saved as “off,” regardless of the state of the DRUM TRACK button.

## MIDI transmission and reception for the drum track

In Program mode, the Drum Track function transmits and receives on the following MIDI channels.

**Receive:** If you’re controlling the triggering by playing the keyboard, the drum track will receive on the global MIDI channel.

**Transmit:** The drum track will transmit on the MIDI channel that’s specified by the Drum Track **Prog MIDI Ch** (default: channel 10) which can be found on the G-MIDI>OUT page. (Note data etc. of the Drum Track program will be transmitted.)

**Note:** MIDI transmission of the pattern data is enabled if Drum Track **Prog MIDI Out** is selected. The default setting is off (unselected).

The Drum Track program does not transmit or receive program changes.

## Drum Track function settings in Combination mode

### MIDI transmission and reception for the drum track

In Combination mode, the Drum Track function transmits and receives on the following MIDI channels.

**Receive:** If you’re controlling the triggering by playing the keyboard, the drum track will receive on the global MIDI channel.

**Transmit:** The drum track will transmit on the MIDI channel that’s specified by the **Output** (C-DRUM TRACK>CHANNEL) setting of each combination.

Set this to match the MIDI channel of the timbre you’ve specified for the drum program.

If the timbre’s **Status** (COMBI> PROG) is EXT or EX2, the note data etc. of the Drum Track pattern will be transmitted.

## Drum Track function settings in Sequencer mode

The structure of parameters related to the drum track function is the same in Sequencer mode as in Combination mode. Assign the Drum Track program to the desired track 1–16.

However, while a combination triggers the Drum Track pattern on the global MIDI channel, a song triggers the Drum Track pattern on the MIDI channel specified by the **Input** (S-DRUM TRACK> CHANNEL). Normally you'll set this to Tch. With the Tch setting, the MIDI channel of the track selected by **Track Select** will automatically be used as the trigger channel.

For details, please see "Selecting a Drum Track pattern and Drum Track program" on page 84.

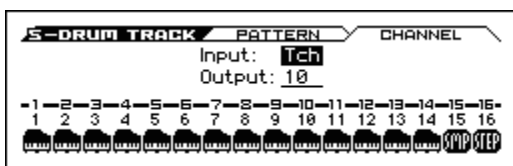

In Sequencer mode you can use the Drum Track function while realtime-recording a song track or pattern.

The note-on/off data transmitted by the Drum Track pattern can be recorded as events in a track or pattern.

⚠ You can't use note data from the internal sequencer as a trigger to start patterns for the Drum Track function.

When you've used the Drum Track function with a program or combination to come up with an idea for a song, you can then use the Auto Song Setup function to immediately start realtime-recording. (see page 60)

## MIDI transmission and reception for the drum track

In Sequencer mode, the Drum Track function transmits and receives on the following MIDI channels.

**Receive:** The drum track will receive on the MIDI channel specified by the **Input** (S-DRUM TRACK> CHANNEL) setting of each song. Normally you'll set this to Tch and use the KROSS's keyboard to control the triggering.

**Transmit:** The drum track will transmit on the MIDI channel specified by the **Output** (S-DRUM TRACK> CHANNEL) setting of each song. Set this to match the MIDI channel of the MIDI track where you've assigned the drum program.

If the track's **Status** (SEQ> PROG) is BTH, EXT, or EX2, note data etc. of the Drum Track pattern will be transmitted.

## Synchronizing the Drum Track function

### The Trigger "Sync" parameter

The trigger timing of a drum track will depend on the setting of its Trigger **Sync** parameter. (Please see page 53, page 86 of the Parameter Guide)

**On (checked):** The trigger timing will be quantized to the nearest beat relative to the base tempo.

**Off (unchecked):** If **Trigger Mode** is set to Start Immediately, triggering will occur at the moment you press the DRUM TRACK button. If this is set to Wait KBD Trigger, triggering will occur at the moment you play the keyboard.

### Synchronization with the arpeggiator, step sequencer, and Sequencer mode songs

Turn the Sync setting On if you want the Drum Track patterns to play or record in synchronization with the arpeggiator that's currently running, the step sequencer, or the song that's currently playing.

**Sync is off:** If the **Trigger Mode** setting is set to Start Immediately, the Drum Track pattern will be triggered the moment you press the DRUM TRACK button. If this is set to Wait KBD Trigger, the Drum Track pattern will be triggered the moment you play the keyboard. The Drum Track will not synchronize with the arpeggiator that's currently running, the step sequencer, or the song that's currently running.

**Sync is on:** The Drum Track will be triggered at one-measure intervals in synchronization with the song that's currently running. The Drum Track will be triggered at one-beat intervals in synchronization with the arpeggiator that's currently running or the step sequencer (in Sequencer mode if the song is stopped).

**Note:** If you want to synchronize the arpeggiator to the Drum Track function that's currently running, adjust settings for **Key Sync** (P-ARP> SETUP, C-ARP> A, B, S-ARP> A, B).

### Synchronization with song stop

#### Synchronization with a song in Sequencer mode

- When you press the SEQUENCER ► / ■ (START/ STOP) button, the Drum Track function will stop as well as the sequencer.
- If you want the Drum Track function to start simultaneously with the start of recording, press the DRUM TRACK button during the pre-count before recording (if **Trigger Mode** is set to Start Immediately) or play the keyboard (if **Trigger Mode** is Wait KBD Trigger). The Drum Tracks will not be triggered immediately, but will be triggered in synchronization with the sequencer the moment recording starts.

---

## Slave operation

Connect the KROSS's MIDI IN to your external MIDI device's MIDI OUT, or connect the KROSS's USB B connector to your computer's USB port.

Set **MIDI Clock** (see page 117) to External MIDI or External USB.

**Note:** If the KROSS is set to **MIDI Clock**= Auto, it will also synchronize to the external MIDI device in the same way if MIDI timing clock messages are being received from the external device.

### Synchronization to MIDI clock

The arpeggiator function will synchronize to a tempo based on the external MIDI clock timing.

### Synchronization with MIDI realtime commands

In Sequencer mode, Song Start, Continue, and Stop messages that the KROSS receives will control song playback and recording just as when you use the front panel SEQUENCER ► / ■ (START/STOP) button. The Drum Track function also will be controlled in the same way as when you use the front panel SEQUENCER ► / ■ (START/STOP) button. (see "Synchronization with song stop")

---

## Master operation

If you want an external MIDI device or computer to synchronize to the KROSS's MIDI timing clock and realtime commands, connect the KROSS's MIDI OUT to your external MIDI device's MIDI IN, or connect the KROSS's USB port to your computer's USB port.

Set **MIDI Clock** to Internal.

**Note:** The same applies if **MIDI Clock**=Auto and MIDI realtime clock messages are being transmitted. (see page 117)

### Synchronization via MIDI clock

The connected external MIDI device will synchronize to the MIDI clock of the KROSS.



# Step sequencer

## Performing with the step sequencer

The **step sequencer** is a function that lets you use the front panel pads 1–16 to easily create drum loop patterns. By turning steps on/off you can create patterns in an intuitive way, and modify a pattern while it plays back.

The step sequencer can be used in Program, Combination, or Sequencer mode; the loop patterns that you create can be saved together with the sound and song data.

A loop pattern consists of up to 64 steps, and you can add volume accents and a sense of swing to the steps. A pattern can use up to 12 different tones, such as kick or snare. You can edit the number of steps in a pattern, and specify the instrumental sounds (Inst) that will actually be sounded by the tones.

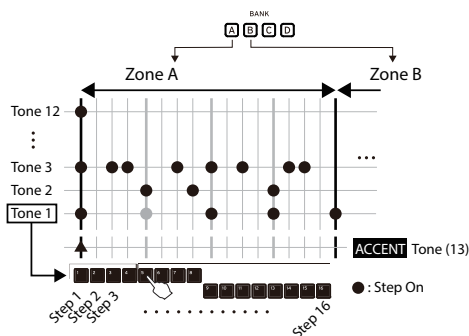

The sounds used by each tone can be selected from the variations of the currently selected drum set. You can also exchange the drum set itself.

## Playback and settings in Program mode

### Playing and stopping the step sequencer

1. Select the program that you'll use when playing the step sequencer or when entering the pattern. (see "Selecting Programs" on page 27)

2. Press the **RUN** button to start playback (the button will be lit).

Press the button once again to stop (the button will be unlit).

The drum loop pattern that's saved together with the program sound will play.

**Note:** The on/off state of the RUN button is not saved when you write the program.

### Changing the tempo

- In REALTIME CONTROLS, select TEMPO and use the KNOB 1 knob (TEMPO) or the SWITCH button (TAP) to adjust the tempo. (see page 73)

### Entering a pattern

Use pads 1–16 to enter a pattern.

1. Make sure that the **STEP SEQ ACTIVE** button is lit.

Pads 1–16 will turn each of the step sequencer's steps on/off.

2. Press the **RUN** button (it will light up) to start playback.

3. Press pads 1–16 to enter steps. Each time you press a pad 1-16, it alternates between on (lit) and off (unlit); a pad that is on will sound.

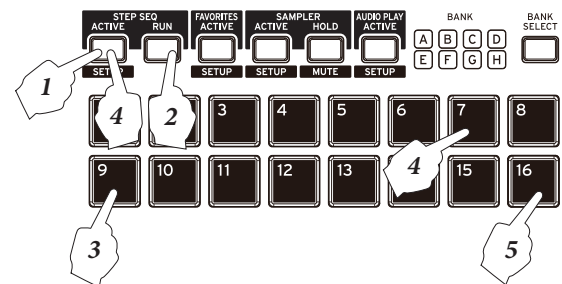

4. To enter a different tone, switch tones. Hold down the **EXIT** button ( **SHIFT** ) and press the **STEP SEQ ACTIVE** button ( **SETUP** ) to access the **P-STEP SEQ>EDIT** page.

The P-STEP SEQ> EDIT page will appear. On this page, you can use the cursor buttons ▲▼ to select the tone that you want to enter. Hold down the STEP SEQ ACTIVE button and press pads 1-13 to switch tones. You can also use the cursor buttons ◀▶ to select a step, and press the ENTER button to turn it on/off.

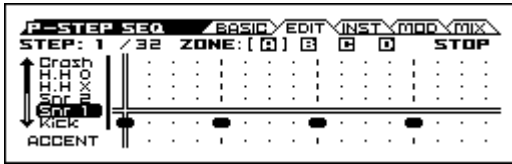

Specific sounds such as kick, snare, and tom are already assigned to the 12 tones used by the step sequencer.

Tone 1	Kick	Tone 5	H.H Open	Tone 9	Tom H
Tone 2	Snare 1	Tone 6	Crash	Tone 10	Perc 1
Tone 3	Snare 2	Tone 7	Ride	Tone 11	Perc 2
Tone 4	H.H Close	Tone 8	Tom L	Tone 12	SFX

**Note:** If you hold down the STEP SEQ ACTIVE button, the currently selected tone number will light up. If you press this button, the ASSIGN INST TO TONE dialog box will appear. In this dialog box you can change the sound that's assigned to the tone. Please see the following section.

5. Press pads 1–16 to enter steps for the next tone.

## Changing the drum sounds

### Switching the sounds of all tones (switching the drum set)

Here's how to change the drum sounds.

1. Access the Program mode P-STEP SEQ>BASIC page.



2. Select Program, and use the VALUE dial etc. to change the drum program.

### Changing the sounds (instruments) for each tone

Variations are provided for the sounds that are played by each tone.

1. While you hold down the STEP SEQ ACTIVE button, the currently selected TONE 1–12 pads will light up. To specify an instrument, select the pad for the TONE that you want to specify, making that pad light up; then press the lit pad to access the ASSIGN INST TO TONE dialog box.

**Note:** Tone 13 is the accent tone. You cannot assign an instrument to it.

**Tip:** You can also access this dialog box by using the Assign Inst To Tone function.

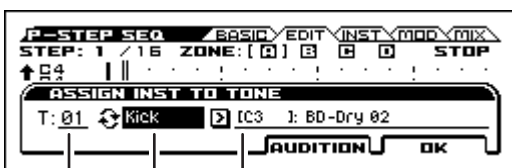

Tone No.    Inst variation category    [Note No.] Inst variation category

2. Use the cursor buttons ◀▶ to select Inst variation category, and press the ENTER button to switch between categories and All.

If All is selected, you'll be able to choose drum sounds from all instruments. If a category is selected, you'll be able to choose from instruments of that category.

- ▶ If the category is set to Inst variation category, switching programs may also switch the note number of the Inst variation. This is because an instrument of the same category does not exist at the same note number as the program that you changed, and therefore a nearby instrument of the same category has been assigned.

3. Use the VALUE dial etc. to select an instrument.

You can press the PAGE+ (AUDITION) button to hear the sound you selected.

You can also play the keyboard to hear the candidate instrument. If Inst variation category is set to All, all keys will produce sound. If a category is selected, sound will be produced only by the keys where a corresponding instrument has been assigned.

You can also select by holding down the STEP SEQ ACTIVE button and playing a key.

4. To specify the sound for another tone, hold down the STEP SEQ ACTIVE button and press a pad 1–12 to switch tones, or choose Tone No. and use the VALUE dial etc. to change the setting.
5. When you've finished adjusting settings, press the MENU (OK) button.

## Adjusting how the loop pattern will play

You can adjust the volume, the sense of swing (groove), and accent for the pattern.

1. Access the P-STEP SEQ> MOD page.



2. Velocity adjusts the basic volume, SWING adjusts the sense of swing, and Accent adjusts the volume.

### Modulation Control - SWING

If Resolution = ♩ (when Steps per Beat = X1)

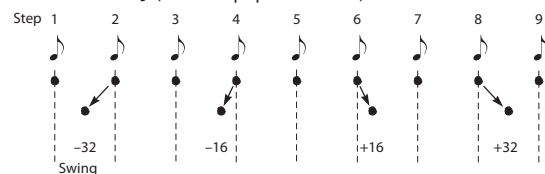

## To add an accent to a step

1. While holding down the STEP SEQ ACTIVE button, press pad 13 to select the accent tone.
2. Turn on the steps where you want to boost the volume. Using pads 1–16 and the BANK SELECT button, press the steps where you want to add an accent, making those steps light up. The volume of all tones in the selected steps will be emphasized.
3. The accent volume is adjusted by the Accent parameter on the MOD page as described earlier.



### To add a sense of swing to the steps

1. On the P-STEP SEQ> BASIC page, adjust the Step/Bt parameter.

A swing effect will be added at the following locations. (see below)

2. On the P-STEP SEQ> MOD page, adjust the Swing setting.

### Specifying the zone

You can use up to 64 steps in a loop pattern. The loop pattern consists of four zones, A–D, each zone containing 16 steps that correspond to the 16 pads.

The number of steps in the pattern is specified by the Lgth (Length) setting on the P-STEP SEQ> BASIC page.

1. Access the P-STEP SEQ> BASIC page.

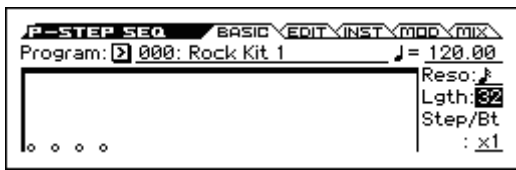

2. Use the Lgth (Length) setting to specify the number of steps.

The pattern will play as a loop for the specified number of steps.

The tempo and Reso (Resolution) settings determine the speed.

Use the BANK SELECT button to switch between zones for the specified Lgth. For example if Lgth is 32, two zones will be available; pressing the BANK SELECT button will switch between zones A and B.

### MIDI transmission from the step sequencer

In Program mode, the step sequencer function transmits note data on the following MIDI channel.

Data is transmitted on the MIDI channel specified by the Global/Media mode G-MIDI>OUT page setting Step Seq Prog MIDI Ch (default setting: ch.16).

**Note:** MIDI data transmission is enabled if the Step Seq

Resolution = , Swing = +16  
When Step/Bt = X1

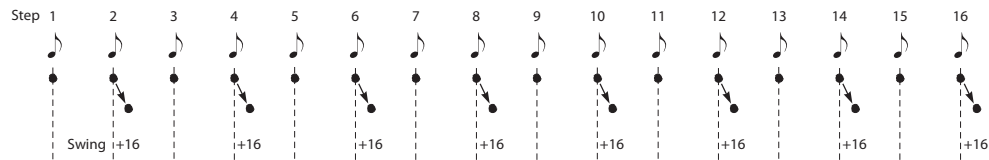

Resolution = , Swing = +16  
When Step/Bt = X2

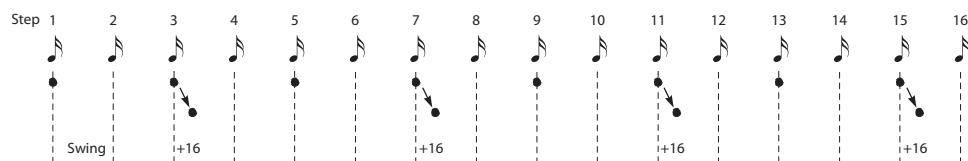

Resolution = , Swing = +16  
When Step/Bt = X4



Prog MIDI Out setting is checked. By default, this is off (unchecked).

Step sequencer programs do not transmit or receive program changes.

## Step sequencer settings in Combination mode

In Combination mode, timbre 16 is used by the step sequencer. It will be used if the COMBI> PROG page STEP parameter is selected. If the STEP parameter is not selected, timbre 16 can be used as a conventional timbre.

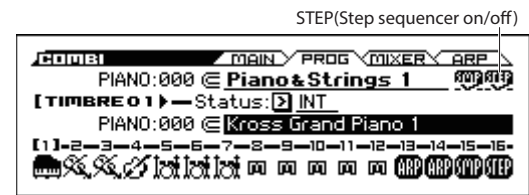

### MIDI transmission from the step sequencer

In Combination mode, the step sequencer function transmits the step sequencer's note data on the MIDI Channel (C-TIMBRE>MIDI) if timbre 16's Status (COMBI>PROG) is set to EXT or EX2.

## Step sequencer settings in Sequencer mode

In Sequencer mode, track 16 is used by the step sequencer. It will be used if the SEQ> PROG page STEP parameter is selected. If the STEP parameter is not selected, timbre 16 can be used as a conventional track.

**Note:** If you press the RUN button during the recording pre-count, the step sequencer will start in synchronization with the beginning of song recording.

## MIDI transmission from the step sequencer

In Sequencer mode, the step sequencer function transmits the step sequencer's note data on the MIDI Channel (S-TRACK>MIDI) if track 16's Status (SEQ>PROG) is set to BTH, EXT, or EX2.

## Using the step sequencer with Favorites

When using the Favorites function, the settings of each registered program or combination can make the step sequencer play.

 You'll be able to turn steps on/off, but the settings cannot be saved. Nor can you enter the various STEP SEQ pages. You'll need to use Program mode or Combination mode to edit the step sequencer settings.

## Playing and stopping the step sequencer

1. Select a favorite program or combination. (see page 53)
2. Press the STEP SEQ RUN button to start playback (the button will be lit).

Press the button once again to stop (the button will be unlit).

The drum loop pattern that's saved together with the program or combination sound will play.

**Note:** The on/off state of the RUN button is not saved when you write the program.

## Entering a pattern

1. Press the STEP SEQ ACTIVE button to make the button lit.  
Pads 1–16 will turn each of the step sequencer's steps on/off.
2. Use the BANK SELECT button and pads 1–16 to enter steps. Each time you press a pad, it will turn on (lit) or off (unlit); if it is on, sound will be produced.
3. To enter other tones, hold down the STEP SEQ ACTIVE button and press pads 1–12 to switch tones. Then press pads 1–16 to turn them on/off.
4. To add accents, hold down the STEP SEQ ACTIVE button and press pad 13 to select it; then use the BANK SELECT button and pads 1–16 to turn the accent on/off for each step.

## Synchronizing the step sequencer

The step sequencer will play in synchronization with the internal/external MIDI clock.

### Synchronization with the arpeggiator

The step sequencer will synchronize to the timing of the currently playing arpeggiator.

**Note:** If you want to synchronize the arpeggiator playback to the step sequencer that's currently running, turn Key Sync (P-ARP> SETUP, C-ARP> A, B, S-ARP> A, B) off.

### Synchronization with the Drum Track

In Sequencer mode, the step sequencer will synchronize to the Drum Track pattern that's currently playing.

**Note:** If you want to synchronize the Drum Track pattern playback to the step sequencer that's currently running, select the Sync check box (in each mode, DRUM TRACK> PATTERN page Drum Track setting).

## Synchronization between the step sequencer and the sequencer in Sequencer mode

### When playing or recording a song

- The step sequencer will synchronize to the song in units of one beat.

### Synchronization with song start

- If the step sequencer is on (i.e., the RUN button is on) and running, it will reset to the beginning of the pattern when it receives a song start message.

## Synchronization with the playback of an external sequencer

If “♪ (Tempo)” is EXT (i.e., if the G-MIDI> BASIC page MIDI Clock parameter is set to Ext-MIDI or Ext-USB) in Program, Combination, or Sequencer modes, the step sequencer will synchronize to MIDI timing clock and start messages from an external MIDI sequencer etc. connected via a MIDI cable.

**Note:** The step sequencer will also synchronize in the same way if MIDI Clock is set to Auto and MIDI timing clock messages are being received from a connected MIDI device.

### Synchronization with external MIDI timing clock

The step sequencer will synchronize to “♪ (Tempo)” based on the external MIDI timing clock.

### Synchronization with the MIDI realtime command Start message

If the step sequencer is on and running, it will be reset to the beginning of the pattern when it receives the Start command.

# Pad Sampler

## Performing with the pad sampler

The pad sampler function lets you use the 16 pads on the front panel to easily sample (record) your KROSS performance or an external input, and perform by playing back these samples. The maximum recording time is 14 seconds per pad, and you can play back the samples of up to four pads simultaneously. To record a sample, select one of the pads 1–16, and record the KROSS's performance or an external input. When you record a sample, it is written into the KROSS's RAM; then the data (16-bit, 48 kHz, stereo) is automatically saved to the SD card as a Korg Format Sample file.

A set consisting of the eight banks A–H is called a "session." For each session, you can load the sample data for 16 pads, and switch between banks while you perform.

**Note:** The KROSS's effects cannot be applied to the playback of the pad sampler.

**Note:** We recommend that you use an SD card. If a card is not inserted, demo samples are loaded into bank A; you will be able to perform.

## Recording samples (sampling)

### Getting ready to record samples



 Before you record, insert an SD card formatted by the KROSS into the SD card slot. If an SD card is not inserted; you will be able to record, but the recorded content is lost when you turn off the power.

**Note:** When you use an SD card with the KROSS for the first time, the folder KORG/KROSS2/SAMPLER is created automatically, and settings are made to prepare the card for use.

**Note:** If you insert an SD card that was previously used with the KROSS, the sample set of Session 001 bank A saved on the SD card is automatically loaded into the KROSS.

## Sampling the sound of the KROSS

Here's how to sample the sound of your performance in Program mode or Combination mode, a sequencer song, or audio processed by the vocoder.

1. In Program mode etc., select the sound that you want to sample. (→ p.27, → p.45)
2. Press the EXIT button (  ) and the SAMPLER ACTIVE button (  ) to access the SAMPLER SETUP window.

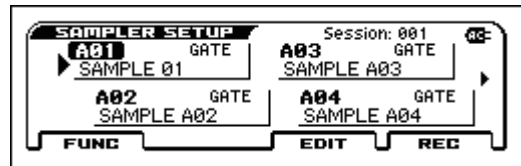

3. Either press the pad to which you want to assign the sample, or use the cursor buttons to select pad.
4. Press the MENU (REC) button located below the display to access the SAMPLE RECORDING window.



If you select a pad to which a sample is already assigned, and press the MENU (REC) button, a dialog box appears, asking whether you want to overwrite the sample.

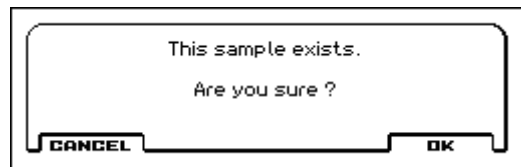

**Note:** If you don't want to delete the sample, press the FUNCTION (CANCEL) button below the display to cancel the operation; then select a different pad.

**Note:** If you want to record a sample in a different bank than the currently selected bank, press the BANK SELECT button to select a bank.

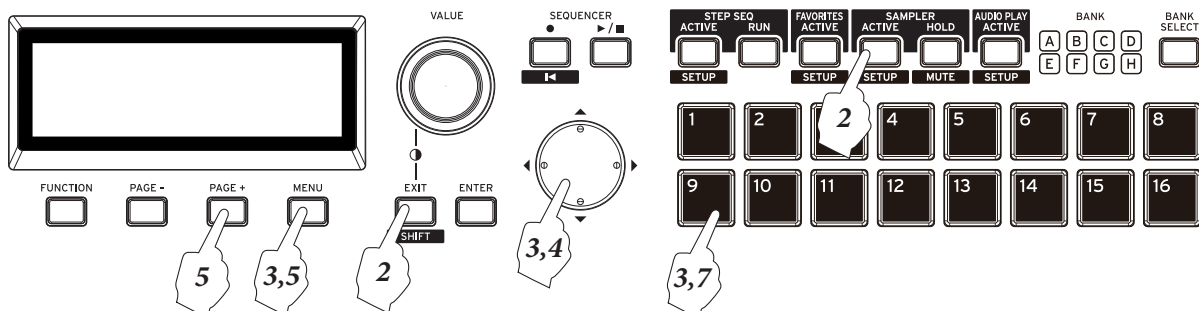

5. Move the cursor to Auto Rec Start:, and use the ENTER key or the VALUE dial to select the auto trigger method.



**Off:** Press the MENU (Rec Control) button to start sampling.

**Note-On:** Sampling will start when you play the keyboard.

**SEQ START:** Sampling will start when you press the SEQUENCER ►/■ (start/stop) button.

**Input Low:** Sampling will start when the audio input level exceeds approximately -18 dB.

**Input High:** Sampling will start when the audio input level exceeds approximately -6 dB.

6. Press the MENU (Rec Control) button to enter sample-standby.

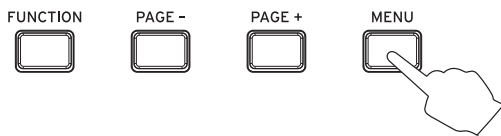

7. Sample the sound of your performance. Sampling starts according to the method you specified Auto Rec Start.

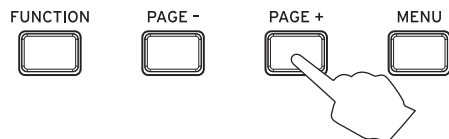

8. When you press the PAGE+ (Stop) button, sampling stops. Sampling automatically stops if the maximum recordable time elapses.

**Note:** During sampling, you can use the AUDIO REC ►/■(play/pause) button to play back an audio song, or play back samples of other pads to sample them. (You can't play back an audio song from a pad.)

9. When you stop sampling, the EDIT SAMPLE window appears. In the EDIT SAMPLE window, You can specify the playback region and playback method of the sample. (“Editing a sample” on page 95)

10. When you press the pad that you recorded, the sample plays back. (“Playing samples” on page 96)

## Sampling the sound from external audio input

If you want to sample an external audio input, proceed through step 3 of “Sampling the sound of the KROSS” on page 93 and then press the PAGE- (A-IN) button to access the AUDIO IN-QUICK SETTING dialog box and change audio input settings. (→ p.22)

When you finish making settings, press the MENU (DONE) button to return to the SAMPLE RECORDING window.

## Importing from a WAVE file

WAVE files saved on an SD card can be imported as samples and played from the pad sampler.

The following file formats can be imported.

- File format: WAVE format uncompressed linear PCM
- Sampling bit depth: 16-bit
- Sampling frequency: 44.1 kHz or 48 kHz, stereo files

**Note:** The first 8 characters of the file name are shown.

1. Using your computer, copy the WAVE file that you want to import into the KORG/KROSS2/DATA folder of an SD card that was formatted by the KROSS.
2. Insert the SD card, and in the SAMPLER SETUP window, select the import-destination pad.
3. Press the FUNCTION (FUNC) button to access the function list; then select Import WAV, and press the ENTER button to access the dialog box.(Please see “Import WAV” on page 206 of the Parameter Guide)

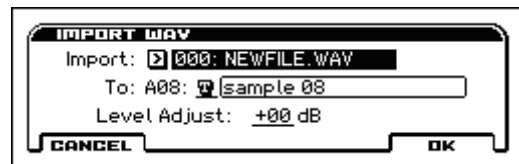
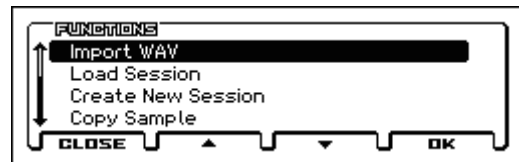

4. In the file list, select the WAVE file that you want to import.
5. Verify the import-destination pad number, and press the MENU (OK) button to execute the import.

**Note:** Up to the first 14 seconds of the WAVE file can be imported. Using your computer beforehand, make sure that the audio you wish to import is within this limit.

**Note:** Importing might take a certain amount of time.

**Note:** From the SAMPLE RECORDING screen as well, you can use the FUNCTION (FUNC) button to select Import WAV and execute the procedure in the same way.

## Editing a sample

**Note:** The edited content is also automatically saved to the SD card each time.

You can specify the playback region and playback method of the sample.

1. Press the EXIT button ( **SHIFT** ) and the SAMPLER ACTIVE button ( **SETUP** ) to open the SAMPLER SETUP window.
2. Either press the pad to which the sample you want to edit is assigned, or use the cursor keys to select pad.
3. Press the MENU (EDIT) button to open the EDIT SAMPLE window.

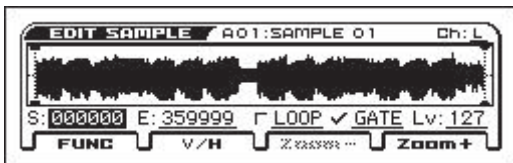

**Note:** You can press the pad to actually play the sample while you adjust the settings and hear the result.

4. To specify the region that plays back, use the VALUE dial to move the "S" start point and "E" end point.

**Note:** The start point and end point are shown in the waveform display. You can use the PAGE+ (ZOOM-) and MENU (ZOOM+) buttons to adjust the range of the waveform display as you check the playback region. You can use the PAGE- (V/H) button to switch between zooming in the V (vertical) or H (horizontal) directions. The selected direction is shown in bold.

**Note:** By using the Truncate Sample function you can discard the portions of the sample that are outside the specified start point and end point.

**Note:** Be aware that a sample on which Truncate Sample was executed cannot be returned to its previous state.

5. Specify the playback method. Use the "LOOP" check box to specify the loop on/off setting, and use the "GATE" check box to specify the gate on/off setting.

**If the "LOOP" check box is on:** The sample plays from the start point to the end point, and then playback continues from the start point.

**If the "LOOP" check box is off:** The sample plays from the start point to the end point, and then playback stops.

**If the "GATE" check box is on:** While the pad is held down, playback continues according to the loop on/off setting. Playback stops when the pad is released.

**If the "GATE" check box is off:** Once the pad is pressed, playback continues according to the loop on/off setting. Playback stops when the pad is pressed once again.

6. To adjust the playback volume, use "Lv" to specify the level.
7. To rename the sample, use the FUNCTION (FUNC) button to open the function list, and select Rename Sample. (Please see "Rename Sample" on page 207 of the Parameter Guide)
8. When you've finished making settings, press the EXIT button to close the EDIT SAMPLE window. When you close the window, the edited content is saved to the Korg format sample file on the SD card.

**Note:** If you don't close the EDIT SAMPLE window, the edited content is not saved to the Korg format sample file on the SD card.

## Playing samples

1. Make sure that the SAMPLER ACTIVE button is lit.
2. Select the sampler bank.

Press the BANK SELECT button to make the BANK LEDs indicate the bank that you want to select; the BANK LED blinks. When 1 second has elapsed with the LED blinking, the switch to that bank is confirmed.

**Note:** While the BANK LED of the selected bank is still blinking, the bank switch has not yet been confirmed. Blinking stops if you select the bank in which you're currently working.

**Note:** Data is read when you switch banks. Never remove the SD card while this is occurring.

3. When you press a lit pad, the sample plays according to the settings that you specified in "Editing a sample".

**Note:** A pad whose sample is currently playing is lit more brightly than when it is not playing.

**Note:** The pad sampler can play back up to four samples simultaneously.

### Hold the pad

If you hold down the SAMPLER HOLD button and press a pad, it remains in the hold state even if you then release the pad.

**Tip:** The same result occurs if you hold down a pad and press the SAMPLER HOLD button.

**Note:** If sample playback ends while a pad is still in the hold state, the hold state is cleared for that pad.

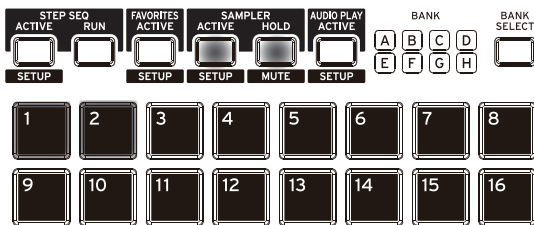

**Note:** If even one pad is in the hold state, the SAMPLER HOLD button is lit. In this case, you can once again hold down the SAMPLER HOLD button and press another pad to simultaneously put it in the hold state. At this time, you can press and release the SAMPLER HOLD button to clear the hold state for all pads.

### switch the pad to mute mode

If there is a pad that is playing, you can hold down the EXIT button ( **SHIFT** ) and press the SAMPLER HOLD button ( **MUTE** ) to switch the pad to mute mode. (At this time, the SAMPLER HOLD button ( **MUTE** ) LED blinks.)

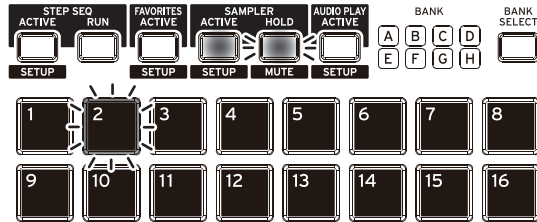

In mute mode, pressing a currently-playing pad will mute (silence) the playback. (The LED of a muted pad blinks.) When you once again press a blinking pad, mute is cleared. To clear mute mode, once again hold down the EXIT button ( **SHIFT** ) and press the SAMPLER HOLD button ( **MUTE** ).

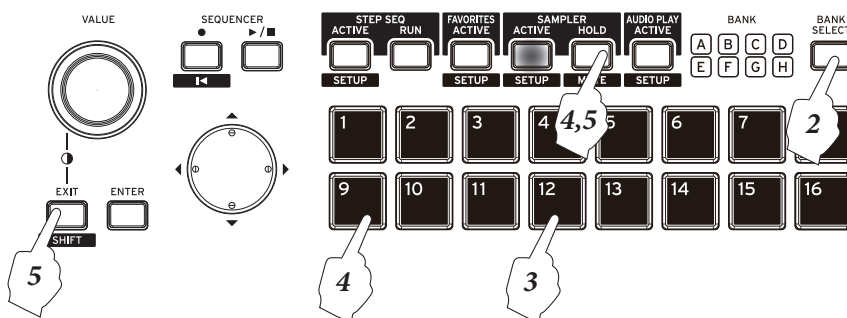

## MIDI transmission and reception for the pad sampler function

### Program mode

Data is transmitted and received on the MIDI channel specified by the Global/Media mode G-MIDI>OUT page setting Pad Sampler Prog MIDI Ch (default setting: ch.15).

MIDI data transmission is enabled if the Pad Sampler Prog MIDI Out setting is checked. By default, this is off (unchecked).

### Combination mode

If in the PROG page you turn "SMP" on, the program assigned to timbre 15 is disabled (will not sound), and instead the pad sampler on/off events are transmitted and received on the MIDI channel that is assigned to timbre 15. If the MIDI timbre's Status (COMBI > PROG) is EXT or EX2, note data is transmitted.

**Note:** It is not possible to change the timbre used for the pad sampler to any setting other than 15.

### Sequencer mode

If in the MAIN or PROG page you turn "SMP" on, the program assigned to track 15 is disabled (will not sound), and instead the pad sampler on/off events are transmitted and received on the MIDI channel that is assigned to track 15. This lets you record and play back on the track. If the track's Status (SEQ>PROG) is BTH, EXT, or EX2, note data is transmitted.

**Note:** It is not possible to change the track used for the pad sampler to any setting other than 15.

## Using samples in other ways

Samples recorded on the KROSS can also be used in other ways as well as playing them back from the pads.

Here are some possibilities.

- Use for recordings in Sequencer mode
  - Pad playback (on/off) data can be recorded as note data in Sequencer mode. ("Recording your pad sampler performance" on page 62)
- Play samples as programs
  - A bank (session) of recorded samples can be converted to a program and played on the keyboard or processed by the KROSS's effects. ("Convert Current Bank to Program" on page 207 of the Parameter Guide)

## Exporting a sample

Using the "Export to KSC" function or "Export to WAV" function, a sample that you recorded with the pad sampler can be exported as a .KSC file or as a sample file in WAVE format. When you execute these functions, a .KSC file or WAVE file is created in the SD card's KORG/KROSS2/ DATA folder.

### .KSC file:

The data is exported as a Korg-format PCM data file, with a multisample and sample file for each bank. This data can be loaded into a sampling-capable model such as the KRONOS series, OASYS, M3, or TRITON series, and played.

### WAVE file:

The data is exported as a .WAV format sample file. A computer application that supports WAVE format can load this data, allowing you to use samples that were recorded on the KROSS.

- File format: WAVE format uncompressed linear PCM
- Sampling bit depth: 16-bit
- Sampling frequency: 48 kHz





# Audio recorder

## An overview of the audio recorder

### About the audio recorder

The KROSS provides a high-quality digital audio recorder that records on an SD card that you insert into the SD card slot. In addition to recording the sound of what you play on the keyboard or play back from the sequencer, the audio recorder can also record an external audio input such as a mic, guitar, or audio player that's connected to the KROSS. You can also overdub as many times as you like by playing back the recorded audio while recording your KROSS performance or external audio input. There's also an Undo function that lets you return to the state prior to the previous take, and re-record from there. These functions let you use the audio recorder like a simple multi-track audio recorder.

The recorded audio data is saved on the SD card as a WAVE file (48 kHz, 16-bit), so you can use it with your computer.

You can also import a WAVE file into the audio recorder and play it back.

The audio recorder gives you an easy way to record your phrases and ideas anytime you're playing, regardless of the sound or mode (except for Disk mode).

### Recording time and data size

The maximum time for one song is three hours. The actual total time for a multi-track recording will depend on the free capacity of the SD card.

A single pass of recording will store approximately 11 MB of data per minute. This means that 1 GB allows you to record approximately 90 minutes. When you perform multi-track recording, additional data will be stored on the SD card according to the length of the recording.

**Note:** Recording times are approximate. Since song management data is also stored, the actual recordable time may be shorter depending on the number of songs.

### Recorded takes and how they play back

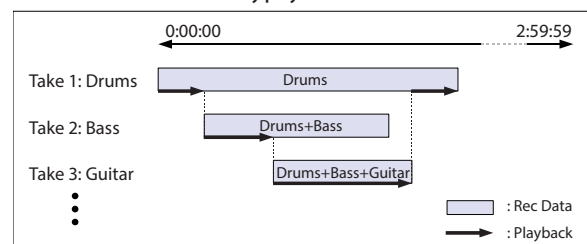

\* The effects designed for use with external audio can be used simultaneously with the insert/master effect provided for programs etc. (see page 71)

### Signal flow within the audio recorder

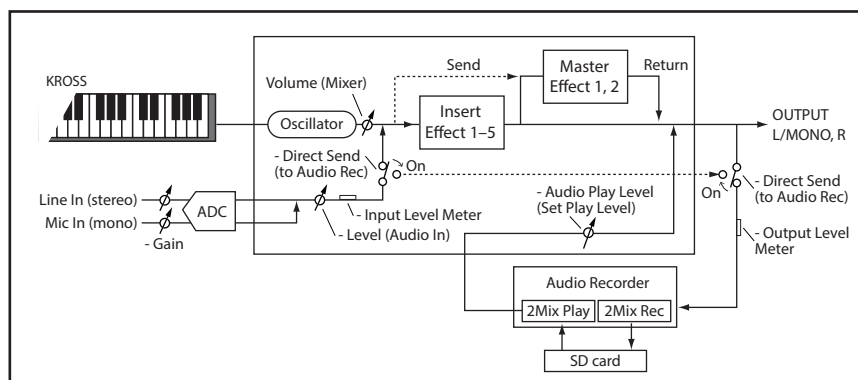

### Recording

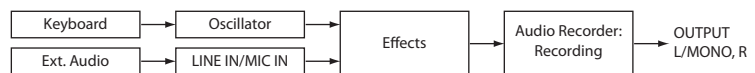

### Playback



### Overdub Recording

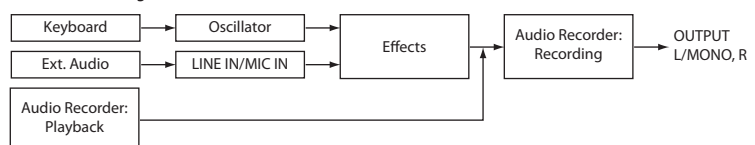

## Basic operation

To perform audio recorder operations such as recording, playback, and undo, use the front panel AUDIO REC ►/|| (play/pause) button ( **SETUP** ), and also the audio recorder dialog box that appears when you hold down the EXIT button ( **SHIFT** ) and press the AUDIO REC ►/|| (play/pause) button ( **SETUP** ).

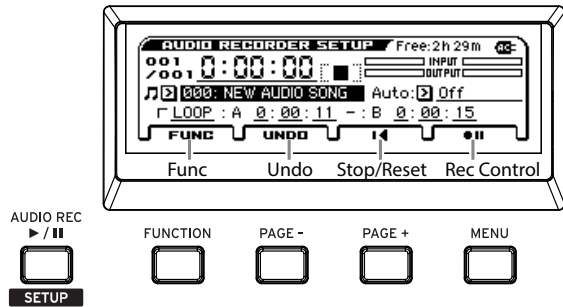

### AUDIO REC ►/|| (play/pause) button ( **SETUP** )

Controls recording, playback, and pause for the audio song. The operating status is shown by the color, and the state of the LED (lit or blinking). In each state, pressing this button will perform the following actions.

- LED unlit = Stopped: Press the button to start playback.
- Green LED blinking = Playback paused: Press the button to start playback.
- Green LED lit = Playing: Press the button to pause playback.
- Red LED blinking = Recording paused: Press the button to start recording.
- Orange LED blinking = Recording paused: Start recording by inputting the trigger specified by Auto.
- Red LED lit = Recording: Press the button to pause recording.

If you hold down the EXIT button ( **SHIFT** ) and press the AUDIO REC ►/|| (play/pause) button ( **SETUP** ), the AUDIO RECORDER SETUP window appears.

### AUDIO RECORDER SETUP window

In this window you can control recording, stop, pause, and playback, as well as perform functions such as undo and create a new audio song. Use the buttons located below the display to operate the recorder.

#### FUNCTION (FUNC) button

This button shows the function list where you can use functions such as creating a new sound, renaming, deleting, exporting, or adjusting the level. (see page 8)

#### PAGE- (UNDO) button

Shows the UNDO dialog box. Here is where you can step back to an earlier recording take. You'll also use this button for the Redo function which brings back a recorded take. (see page 104)

#### PAGE+ (Stop/Reset) button

This is the stop button. It stops playback or recording of the audio song. When you stop, the recorder will return to the stored location. If you press locate while stopped, you'll return to the beginning 0:00:00 of the song.

### MENU (REC Control) button

This is the record button. It controls record-pause and record-start. The functionality of the button will depend on the current state. In each state, pressing this button will perform the following actions.

- || = While stopped: Press the button to enter the record-pause state.
- ► = When shown: Press the button to start recording.
- ► = Recording: Press the button to switch to playback.

### Locate

During recording or playback, pressing the PAGE+ (Stop/Reset) button will stop and take you back to the location where you started recording or playing (except if you started from pause).

When stopped, pressing the PAGE+ (Stop/Reset) button will take you to the beginning (0:00:00) of the song.

If you want to move the location, use the cursor buttons ◀▶▲▼ to select Time Location, and press the ENTER button (the ▲▼ symbols are shown beside the value). Use the cursor buttons ▲▼ or the VALUE dial to specify the location, and press the ENTER button to move there.

You can't change the location during recording or in the record-pause state.

### Foot switch

You can use a foot switch to switch between play/play-pause or record/record-pause (Foot SW Assign = Audio Recorder Start/Pause, Audio Recorder REC Start/Stop). (see page 23)

## AUDIO RECORDER SETUP window

In the audio recorder setup window you can adjust settings for the audio recorder.

- Hold down the EXIT button ( **SHIFT** ) and press the AUDIO REC ►/|| (play/pause) button ( **SETUP** ) to open the window.

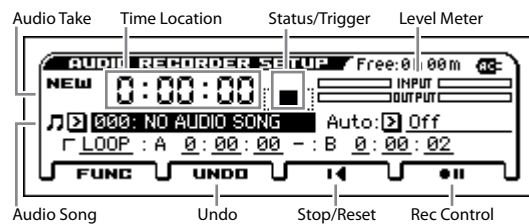

- Audio Take: If you have not yet recorded, this will indicate New. When you record, the left side indicates the currently selected take, and the right side indicates the number of multi-track recordings. You can use Undo to go back to a previous recording.
- Time Location: Indicates the location within the audio song. From the left, this shows hours, minutes, and seconds. Please see the preceding section "Locate" on page 100.
- Status/Trigger: Indicates the state of the audio recorder, such as recording, playing, or stopped.
- Level Meter: The INPUT level meter shows the level of the external audio that's being input to the KROSS. The OUTPUT level meter shows the level of the sound being output from the L/R jacks: the sound of the KROSS, the external audio input, and the playback of the audio recorder. During recording, this will show the recording level.

- Audio Song: Selects a song.
- Auto: Specifies how recording will be started automatically. (see “Specifying how recording will start” on page 104)
- LOOP: Repeatedly plays the A-B region.
- Undo: Returns to a previous take or the most recent take.
- Stop/Reset, Rec Control: Control the audio recorder.

## Recording and playing audio

The audio recorder can record what you play on the keyboard of the KROSS, or it can play an external audio signal from LINE IN, MIC IN or USB audio input.

Let’s begin by recording the sound of your playing a program. In a later section we’ll explain how to record an external audio signal.





### Preparations

- Insert an SD card into the SD card slot. (see “Inserting an SD card” on page 25)
-  If the SD card is being used by the KROSS for the first time, you’ll need to format it in GLOBAL/MEDIA mode. (see “Formatting SD card” on page 129)

**Note:** When using an SD card with the KROSS for the first time, KORG/KROSS2/AUDIO and DATA folders will be created automatically to make the card usable by the KROSS.

-  Never remove the SD card during recording or playback. Doing so may temporarily destabilize the KROSS.

### Recording the performance of the KROSS

1. Press the PROG button to enter Program mode, and select the program that you want to play from the keyboard and record.
2. Hold down the EXIT button (  ) and press the AUDIO REC  (play/pause) button (  ) to open the AUDIO RECORDER SETUP window.
3. Select the audio song that you want to record.
  - If there is no recorded data on the SD card, the display will indicate “NO AUDIO SONG.” Simply proceed to step 4.
  - To select a different song, move the cursor to the audio song and use the VALUE dial etc. to select the song you want. You can press the ENTER button and choose from a list.
  - If you want to newly record a song, prepare a new song. (see “Preparing a new audio song” on page 104)
4. Press the MENU (Rec Control  ) button to enter the record-standby condition. (AUDIO REC  button: blinking red)

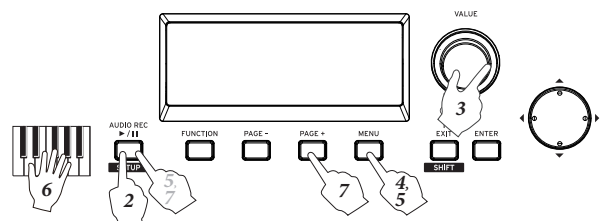

5. Press the MENU (Rec Control ●▶) button or the AUDIO REC ▶/|| (play/pause) button to start recording. (AUDIO REC ▶/|| (play/pause) button: lit red)

*Note:* The procedure here is for when Auto (Auto Rec Start) is Off. As an alternative to the Rec Control button, you can also initiate recording in other ways, such as by playing the keyboard. (see “Specifying how recording will start” on page 104)

6. Perform on the keyboard; the sound of the KROSS will be recorded. You can also record the performance of the Drum Track, the arpeggiator, and the step sequencer.

*Note:* Even if you close the setup window, the recording or standby condition of the recorder will be maintained.

7. To stop recording, press the PAGE+ (Stop/Reset ■) button (AUDIO REC ▶/|| (play/pause) button: unlit). When you stop, you’ll automatically return to the time location where you started recording.

If you press the PAGE+ (Stop/Reset ■◀) button while stopped, you’ll return to the beginning of the audio song.

If you press the AUDIO REC ▶/|| (play/pause) button during recording, you’ll pause in the record-standby state (AUDIO REC ▶/|| (play/pause) button: blinking red).

If you press the MENU (Rec Control ▶) button during recording, recording will end, playback will continue, and the location will advance. To resume recording, press the MENU (Rec Control ●▶) button or the AUDIO REC ▶/|| (play/pause) button.

## Recording external audio input

If you want to record the sound of an external audio input source, proceed as follows.

As an example, we will explain how to record from a mic.

1. Select a mic program.
 

Recording from a mic will be easy if you use a program whose input and effect settings have been set up appropriately for a mic.
2. In the REALTIME CONTROLS section, use the SELECT button to select AUDIO IN 1; then turn off the SWITCH (ON/OFF) button, and turn the VOLUME knob all the way to the left to lower the volume.

Then connect a dynamic mic to the rear panel mic input (MIC IN) jack.

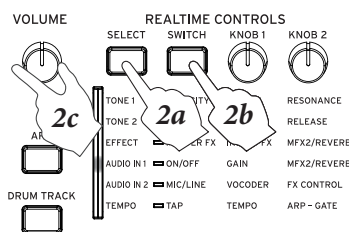

**⚠** You must turn the SWITCH (ON/OFF) button off and use the VOLUME knob to minimize the volume before you connect a mic or any other device. If you fail to observe this precaution, your speaker system or other equipment might be damaged.

*Note:* Also use the MIC IN jack if you’re connecting an electric guitar. If you’re connecting a guitar equipped with passive pickups, we recommend that you connect a preamp or effect unit between your guitar and the KROSS.

3. In REALTIME CONTROLS, press the SWITCH (ON/OFF) button to turn it on (lit). The mic input will be enabled. Turn the VOLUME knob back toward its original position to adjust the volume appropriately, and play the keyboard or play back the audio recorder while you input audio from the mic to check the volume balance. If you want to adjust the mic volume, use the SWITCH (ON/OFF) button to enable the mic input, and then press FUNCTION button? (QUICK SETTING) to open AUDIO IN-QUICK SETTING-, and adjust the GAIN value.

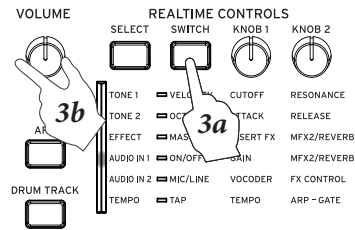

*Note:* You can also adjust GAIN in the AUDIO IN 1 row of the REALTIME CONTROLS section.

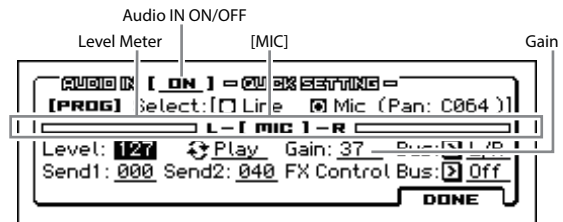

*Note:* Ideally, the level meter should be moving in approximately 70% of its full range. If the input is overloaded, the [MIC] indicator will be highlighted. When you’ve finished adjusting the volume, save the setting. (see “Global audio input settings (G-SET) and individual settings” on page 22)

4. Specify the Direct Send setting. In this example, we will mix and record the KROSS’s performance, so turn the setting off.
5. Adjust effect settings.

In the mic program, the Reverb Hall effect etc., which applies reverberation to your vocal is assigned to Master FX. If you want to turn off the effect, turn the MASTER FX button off. To turn the effect off, use the SELECT button to select the EFFECT row of REALTIME CONTROLS, and turn off the SWITCH (MASTER FX) button.

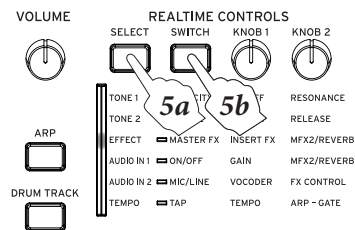

Use AUDIO IN1 - MFX/REVERB to set the amount of effect. In REALTIME CONTROLS, use the SELECT

button to select the AUDIO IN 1 row, and use KNOB 2 to make adjustments.

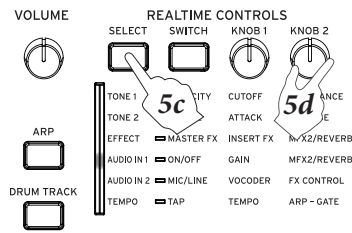

6. Hold down the EXIT button ( **SHIFT** ) and press the AUDIO REC ►/|| (play/pause) button ( **SETUP** ) to open the AUDIO RECORDER SETUP window.
7. Select the audio song that you want to record.
8. Press the MENU (Rec Control ●||) button to enter the record-standby condition.
9. When you press the MENU (Rec Control ●►) button or the AUDIO REC ►/|| (play/pause) button, recording starts.
10. To stop recording, press the PAGE+ (Stop/Reset ■) button. When you stop recording, you automatically return to the time location at which recording started.

*Note:* For details on the screen indications and operations during recording, refer to “Recording the performance of the KROSS”

## Direct Send



Direct Send

Direct Send is a parameter that specifies whether the external audio input sound is mixed with the performance of the KROSS during recording. For example if you're rehearsing in the studio, you could record only the band's performance while you play the KROSS.

**Direct Send off:** The audio input and the KROSS's performance are mixed and recorded.

**Direct Send on:** Only the audio input is recorded. The sound of the KROSS's performance is not mixed. (In this case, the audio input sound is not output from audio out.)

If you want to record only the external audio input sound, turn Direct Send on in step 4 of “Recording an external audio input.”

## Playing back an audio song

To play back an audio song, press the AUDIO REC ►/|| (play/pause) button. Whether you're in Program, Combination, or Sequencer mode, you can play back regardless of the mode you're in.

1. **Select the audio song that you want to play back.**

Hold down the EXIT button ( **SHIFT** ) and press the AUDIO REC ►/|| (play/pause) button ( **SETUP** ) to access the AUDIO RECORDER SETUP page.

Move the cursor to the audio song, and use the VALUE dial etc. to select the song you want.

2. Press the PAGE+ (Stop/Reset I ◀) button to move to the beginning of the sound.
3. Press the AUDIO REC ►/|| (play/pause) button to play back the audio song (green LED lit).
4. Press the AUDIO REC ►/|| (play/pause) button to pause (green LED blinking).
5. Press the AUDIO REC ►/|| (play/pause) button once again to resume playback (green LED lit).
6. Press the PAGE+ (Stop/Reset ■) button to stop playback and return the location to the beginning (AUDIO REC ►/|| (play/pause) button LED unlit).

## Moving the playback location

For details on how to move the playback location of an audio song, please see “Locate” on page 100.

## Multi-track recording

### SD card usage during multi-track recording

When you perform multi-track recording, the audio recorder stores additional data on the SD card in proportion to the recording time (see page 99). If you intend to use the audio recorder for multi-track recording, you should use an SD card with plenty of capacity.

### Multi-track recording procedure

To perform multi-track recording, select an audio song, move the time location to the place where you want to start (whether at the beginning or in the middle of the song), switch sounds or audio input sources if necessary, and repeat the steps described in “Recording the performance of the KROSS” on page 101.

*Tip:* If you want to change the volume when you're repeatedly recording the sound of the KROSS, you can use the Hold function of Program mode or Combination mode to adjust the balance. (see pages 32, 48)

In this example, we'll explain how to record a specific region starting in the middle of the song.

1. **Select the song on which you want to multi-track record.**

Hold down the EXIT button ( **SHIFT** ) and press the AUDIO REC ►/|| (play/pause) button ( **SETUP** ) to open the AUDIO RECORDER SETUP window. Use the cursor buttons ◀▶▲▼ to choose Audio Song, and use the VALUE dial etc. to select a song.



2. **Move to the location where you want to begin multi-track recording.**



For details on how to move, please see “Locate” on page 100.

*Tip:* It's a good idea to move to a point where you can start playback slightly earlier than you begin recording.

3. Press the AUDIO REC ►/|| (play/pause) button to start playback. (AUDIO REC ►/|| (play/pause) button: lit green)
4. Press the MENU (Rec Control ●►) button to start recording. (AUDIO REC ►/|| (play/pause) button: lit red)

Play the keyboard of the KROSS or input audio from the MIC IN or LINE IN jacks.

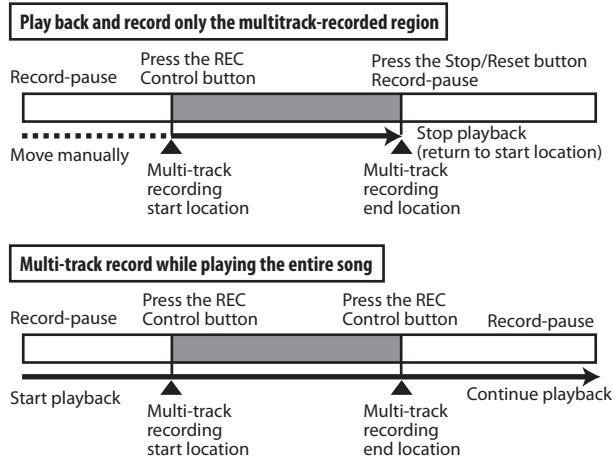

5. To stop recording, press the PAGE+ (Stop/Reset  button (AUDIO REC /  (play/pause) button: unlit).

If you press the MENU (Rec Control  button during recording, recording will end, playback will continue, and the location will advance. To resume recording, press the MENU (Rec Control  button.



### To start recording in synchronization with your performance or input

You can make recording start automatically when you begin playing the keyboard or when external audio input is received.

Select the appropriate Auto setting and press the MENU (Rec Control) button; AUDIO REC /  (play/pause) button will blink orange, and the recorder will be in the record-standby condition. Recording will start automatically when you play the keyboard or input audio. (see “Specifying how recording will start”)

## Preparing a new audio song

1. Press the FUNCTION (FUNC) button to access the function list.
2. Use the PAGE- () button to select Create New Audio Song, and then press the MENU (OK) button. The Create New Audio Song dialog box will appear.
3. To assign a name to the song, press the ENTER button, enter a name in the text dialog box, and then return to this dialog box (see page 124). You can change the name later.
4. Press the MENU (OK) button to create the new audio song.

On the upper left side of the display, the Audio Track will indicate “NEW” to show that this is a new song where nothing has been recorded.

## Convenient functions for playback and recording

### Returning to the state before or after recording (Undo/Redo)

If you’re not satisfied with your performance and would like to record it again, you can use the Undo function to return to the state prior to recording. You can also step back through multiple takes. If you want to cancel the Undo function, use Redo.

1. To cancel the recording, press the PAGE- (UNDO) button.

The UNDO dialog box will appear.



2. Specify the take that you want to use from the previously-recorded takes, and press the OK button.

When you execute UNDO, the PAGE- (UNDO) button will be highlighted.



**Note:** If you record in this state, the Redo data will be lost and the PAGE- (UNDO) button will return to its original appearance.

### Specifying how recording will start



Use the Auto (Auto Rec Start) setting to specify how recording will start automatically. You can make recording start the moment you play a note on the keyboard, or when the sequencer starts, or when the audio input signal reaches a specific level.

1. In the audio recorder setup window, set Auto (Auto Rec Start). For details, please see step 3.
2. Press the MENU (Rec Control ) button to enter the record-standby condition. (AUDIO REC /  (play/pause) button: blinking orange)



3. Off: Press the MENU (Rec Control ) button or the AUDIO REC /  (play/pause) button to start recording.

**Note-On:** Recording will start when you play the keyboard.

**SEQ START:** Recording will start when you press the SEQUENCER /  (start/stop) button.

**Input Low:** Recording will start when the audio input level exceeds approximately -18 dB.

**Input High:** Recording will start when the audio input level exceeds approximately -6 dB.

**Note:** It’s convenient to record using the following method if you want to overdub an external input such as a guitar solo or chorus onto a portion of the audio song.

1. Set Auto (Auto Rec Start) to Input Low or Input High. Adjust input settings for Mic In.

2. Press the AUDIO REC ►/|| (play/pause) button to start playback. (AUDIO REC ►/|| (play/pause) button: lit green)
3. Slightly earlier than the point where you want to start overdubbing, press the MENU (Rec Control ●►) button to enter the record-standby condition. (AUDIO REC ►/|| (play/pause) button: blinking orange)
4. Sing the chorus part. Recording will start automatically in response to the input.

When you overdub using this method, the audio input from 0.2 seconds earlier than the moment you started recording will actually be recorded. This lets you overdub without losing the beginning of the chorus or guitar phrase.

**Tip:** This Auto (Auto Rec Start) setting can be stored in the GLOBAL> PREF 2 page as the default setting.

## Loop playback

There's a loop playback function that lets you repeatedly play a specified region (A–B) of an audio song.

**Note:** The loop play on/off setting and the specified time are saved individually for each audio song.

 This setting will be saved to the SD card when you switch to a different audio song or when you turn off the power. If you remove the SD card immediately after select the setting, the setting will not be saved.

### Using loop play



If you add a check mark to LOOP to turn it on, the playback will loop.

To specify the loop region, set the point where looping will start (point A) and end (point B).

**Note:** The interval between points A and B will be at least three seconds.

 It's not possible to record while LOOP has a check mark. Nor is it possible to add a check mark to LOOP during recording.

### Setting the current time location as a point

There's a convenient function that lets you directly specify the current time location as one of the points. Move the cursor to A or B, and press the ENTER button during playback; the current time location will be specified as a point.



**Note:** If you use this method to specify the time location of a point, the location will be specified with an accuracy of within one second.

## Pad audio play

You can assign a recorded audio song to a pad and play it back. (→ p.109)

## Importing or exporting WAVE files

### Importing

You can import a WAVE file into the audio recorder, and play it or overdub onto it.

The following files can be imported.

- File format: WAVE format uncompressed linear PCM
- Sample bit depth: 16-bit
- Sampling frequency: 44.1 kHz or 48 kHz, stereo files

Number of characters in file name: The first eight characters are shown

**Note:** Since 44.1 kHz WAVE files will be converted into 48 kHz as they are imported into the KROSS, a small amount of time may be required.

### Import procedure

1. Using your computer, copy the WAVE file that you want to import into the KORG/KROSS2/DATA folder of an SD card that was formatted by the KROSS.
2. In the audio recorder setup screen, open the audio song list.
3. The WAVE file that you saved on the SD card in step 1 is shown at the bottom; select the WAVE file that you want to import, and press ENTER to access the dialog box.

**Note:** As an alternative to steps 2 and 3, you can open the same dialog box by using the MEDIA>FILE page to select the WAVE file that you want to import, and then executing the Load Selected function.

4. If you want to rename the song, access the text dialog box and enter a name.
5. If the volume of the file you're importing should be adjusted beforehand, specify Level Adjust.

**Note:** After importing, you can adjust the playback volume of the audio recorder, or apply an individual volume adjustment to each audio song. (see "Adjusting the volume" on page 106)

6. Press the MENU (OK) button to execute the import function.

The selected WAVE file will be loaded in KROSS audio song format. The progress of execution is shown by a progress bar in the display.

**Note:** This may take some time depending on the type of file, etc.

During the import procedure, you can cancel by pressing the FUNCTION (ABORT) button.

7. In the audio recorder setup window, select the song that you imported, and play it.

---

## Exporting a WAVE file

A multitrack-recorded audio song can be exported as a WAVE file to the KORGE/KROSS2/DATA folder of the SD card.

This lets you use your audio player to listen to an audio song produced on the KROSS, or to load the song into your DAW.

- File format: WAVE format uncompressed linear PCM
- Sample bit depth: 16-bit
- Sampling frequency: 48 kHz

Number of characters in file name: The first eight characters are shown

### Export procedure

1. In the audio recorder setup window, select the audio song that you want to export.
2. Choose the Export function to access the dialog box.
3. If you want to rename the file, access the text dialog box and enter a name.
4. If you want to adjust the audio level of the song when exporting it, specify Level Adjust.
5. Press the MENU (OK) button to execute the export function.

The selected audio song will be exported as a WAVE file. The progress of execution is shown by a progress bar in the display.

The WAVE file will be created in the KORGE/KROSS2/DATA folder of the SD card.

**Note:** This may take some time, depending on the length of the song.

During the export procedure, you can cancel by pressing the FUNCTION (ABORT) button..

---

## Adjusting the volume

You can use the following methods to adjust the volume of imported data or of an already-recorded audio song.

If the volume of the imported data is too loud so that it drowns out the performance of the KROSS, or if multi-track recording has caused the volume to overload so that no more can be overdubbed, it is helpful to adjust the volume by using the following functions.

You can make the following adjustments.

- Set Play Level function: Temporarily lowers the playback volume of audio songs.
  - Note:** This will change the volume of all audio songs.
- Adjust Audio Level function: Applies attenuation processing to the audio song, creating a new song.
  - Tip:** Use this function if you want to individually adjust the volume of each audio song.
- Level Adjust: Use the Level Adjust setting during Import or Export.

---

## About the Set Play Level and Adjust Audio Level functions

In the Set Play Level function dialog box, setting the Level to anything other than 0 dB will cause the audio song to play back at a volume that is lower by the level you specified. This function is convenient when you want to adjust the volume balance between the audio song and your keyboard performance.

**Note:** The Set Play Level setting applies to all audio songs.

At this time, the following message will appear. Please note this if you're overdubbing with the audio song playback level lowered.

**NOTICE: Overdubbing with this Level setting will attenuate the sections of previous takes by the same amount. Use ADJ. LVL to adjust the Audio Song and avoid uneven audio level.**

With this Level setting, if you overdub a region of the song while playing back the previous take, the volume of the previous take will be lowered only for the recorded region. To avoid this problem of lowered volume, use ADJ. LVL to adjust the audio song level.



Select the Set Play Level function, and adjust the level as follows.

**1. Set the Level as desired.**

Adjust the volume balance of the keyboard performance or external input (e.g., guitar or vocal) that you will be overdubbing next while the audio song plays back. For example, set this to -3 dB.



**2. Press the PAGE+ (ADJ. LVL) button. The ADJUST AUDIO LEVEL dialog box will appear.**



**3. Use Level Adjust to specify the level adjustment. The Level value you specified in step 1 will automatically be set as the default, so usually you can just press the MENU (OK) button. (You can specify the song name as you wish.)**

You will return to the AUDIO RECORDER SETUP screen. The audio song whose level you adjusted will automatically be selected. At this time, Set Play Level will be reset to 0 dB, so the volume balance you adjusted in step 1 will be reproduced.

**4. Overdub-record additional material. (see the illustration below)**

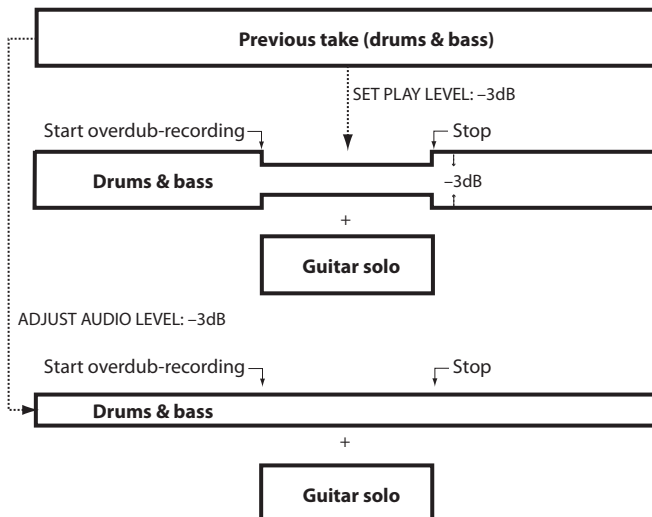

If you overdub-record the guitar solo with SET PLAY LEVEL left at -3 dB. The volume of the previous take (drums & bass) will be 3 dB lower for a portion of the recording, causing an unnatural result.

If you overdub-record the guitar solo after using ADJUST AUDIO LEVEL to lower the volume of the previous take by 3 dB. Unnatural volume changes will not occur in the previous take (drums & bass).

## SD card-related messages

In addition to the Song Name, the following messages related to the SD card may appear in the Song Name area of the audio recorder.

"NO MEDIA"	No SD card is inserted.
"UNFORMATTED"	The format of the SD card could not be recognized.
"NO AUDIO SONG"	There are no audio songs.

*Note:* If the SD card is locked (Media write protected), a different error message "Write protected" will appear if you perform an operation that writes to the SD card, such as recording.



# Pad audio play

## Performing with the pad audio play function

Pad audio play is a function that lets you use the front panel buttons and 16 pads to switch instantly between audio songs recorded by the KROSS's audio recorder or existing audio files.

**Note:** One song (one file) can be assigned to each of the 16 pads. A maximum of one audio song can play back simultaneously.

**Note:** In order to use this function, there must be an SD card formatted by the KROSS which contains audio songs recorded by the KROSS or audio files that meet the requirements listed in "Data that can be played back," below. If the SD card contains no data, this function cannot be used.

### Data that can be played back

- File format: WAVE format uncompressed linear PCM
- Bit depth: 16-bit
- Sampling frequency: 44.1 kHz or 48 kHz, stereo files

## Specifying an audio song and assigning the song to a pad

**Note:** The settings here are also reflected in the AUDIO RECORDER SETUP window.

**Note:** When audio song settings are changed, data is loaded from the SD card. Never remove the SD card while this operation is being performed.

1. While holding down the EXIT button ( **SHIFT** ), press the AUDIO PLAY ACTIVE button ( **SETUP** ) to open the AUDIO PLAY SETUP window.

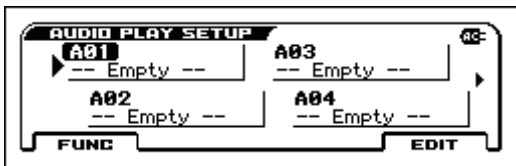

2. Select the audio play bank. Use the BANK SELECT button and the indication of the BANK LEDs to switch banks.
3. Press the pad to which you want to assign an audio song or whose settings you want to change, or use the cursor keys to select it.
4. Press the MENU (EDIT) button to open the AUDIO SONG SETUP window.

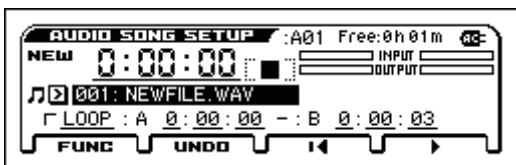

5. Select the audio song that you want to assign.

**Note:** Following the audio songs, the audio song list also shows a list of the WAV files that have been placed in the specified location of the SD card. When you select one of these, the Import WAV dialog box appears.



When you execute Import WAV, the file is imported as a new audio song. ("Importing or exporting WAVE files" on page 105)

6. Select the take of the selected audio song recorded by the KROSS. Use the PAGE- (UNDO) button to open the dialog box, and use the cursor keys to select the take.



7. Adjust settings for loop playback. If you turn on LOOP by adding a check mark, the song loops when it is played back. Specify the loop region by setting the loop start location (point A) and end location (point B).

**Note:** Point A and point B will be at least three seconds apart.

8. You can use the MENU (Start) button and PAGE+ (Stop/Reset) button to play back the audio song and check the above settings.

**Note:** If you move the cursor to A or B, and press the ENTER button during playback, the current time is specified as the playback point.

9. When you've finished making settings, press the EXIT button to close the AUDIO SONG SETUP window.

## Using the pads to play back audio songs

1. Make sure that the AUDIO PLAY ACTIVE button is lit. To turn on the pad audio play function, press AUDIO PLAY ACTIVE button.
2. Pads to which an audio song is assigned are lit. When you press a lit pad, the assigned audio song plays. During playback, the pad is lit more brightly.
3. When you once again press the currently-playing pad, playback is paused and the pad blinks. Pressing the pad once again in this state starts playback from the paused location.

**Tip:** You can also stop the currently playing or paused audio song by pressing the AUDIO PLAY ACTIVE button.

4. When there is a pad whose audio song is playing, you can press a different lit pad to stop the currently-

playing audio song and instantly switch to playing a different audio song.

**5. To switch between banks of assigned audio songs, use the BANK SELECT button and the BANK LEDs.**

Press the BANK SELECT button to make the BANK LEDs indicate the bank that you want to select; the BANK LED blinks. When 1 second has elapsed with the LED blinking, the switch to that bank is confirmed.

*Note:* While the BANK LED of the selected bank is still blinking, the bank switch has not yet been confirmed. Blinking stops if you select the bank in which you're currently working.

*Note:* Data is read when you switch banks. Never remove the SD card while this is occurring.

# Using Drum Kits

## Drum Kit Overview

### What's a Drum Kit?

A drum kit is a collection of drumsamples (drum set sounds such as bass drum, snare, or cymbals, as well as a wide variety of other percussion sounds), with each sample assigned to a note of the keyboard.

- Each key can play a different sound
- On each key, you can use up to four Drumsamples, with velocity crossfades
- Each key has separate settings for the most important sound parameters, including volume, filter cutoff and resonance, envelope attack and decay, and pitch.
- Each note can be routed to different Insert Effects, or have separate FX Send amounts. For instance, you can send a snare sound through a dedicated compressor.

You can use Drum Kits only in Programs whose **Oscillator Mode** is set to **Drums**.

### Drum Kit memory structure

The KROSS has 67 Drum Kits, divided into Internal, User, and GM (General MIDI) groups as shown below. You can edit or write into any of the locations except for the GM bank, which cannot be erased.

*Drum Kit contents*

Bank	No.	Contents
INT	00...41	Preload Drum Kits
User	42...57	User Drum Kits
GM	58...66	GM2 Drum Kits

The 9 Drum Kits in the GM bank are compatible with the GM2 sound map. The other Drum Kits may use different mappings, where appropriate.

### Using a drum kit in a program (Oscillator Mode)

In Program mode page P-BASIC>VOICE, set Oscillator Mode to Drums, and then select the drum kit that will be used by the oscillator.

## Before you start editing...

### Selecting a drum program

Drum Kits are edited in Global/Media mode. While you're in Global/Media mode, you'll play the kit that you're editing as if you were playing it from within the Program, Combi, or Song which was selected before you entered Global/Media mode.

So, before you enter Global/Media mode, it's best to select a Program which is already set up for drums, with the appropriate EG settings, effects, and so on.

In Program mode, you should select a drum program from the DRUM/SFX category.

### Matching the key of the keyboard with the Drum Kit

In order for the note mappings to match the keyboard, the Oscillator's **Octave** setting needs to be **+0 [8']**. All Drum Kit Programs should have this setting already. If you're unsure, you can check this yourself:

1. **Go to the OSC1 Setup tab of the P-OSC> DKit page.**  
With a setting other than **+0 [8']**, the relationship between the keys and the Drum Kit sound map will be incorrect.
2. **Set the GLOBAL> BASIC parameter "Key Transpose" to +00.**

### Make sure that Memory Protect is disabled

Before you start editing, go to the GLOBAL> SYSTEM page, and look in the Memory Protect section. Make sure that **Drum Kit** is not checked—if so, you won't be able to make any edits.

### Drum Kits may be used by more than one Program

When you edit a Drum Kit, all Programs that use that Drum Kit will be affected. To avoid changing the factory voicing, you may wish to copy Drum Kits to empty locations in the USER banks before editing.

## Editing a Drum Kit

### Basic Editing

1. Select the Program that you wish to use while editing the Drum Kit.
2. Access the DRUM KIT> DS 1 and DS 2 pages, turn

Press the EXIT button ( **SHIFT** ) and the SEQ button ( **GLOBAL/MEDIA** ). Press the MENU button to access the menu, use the PAGE- ( **▲** ) or PAGE+ ( **▼** ) buttons to select DRUM KIT, then press the MENU (OK) button. (If a different page is shown, use the PAGE- ( **▲** ) button to select the appropriate page.)

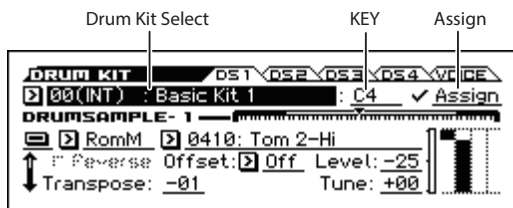

3. On the top line of the display, use “Drum Kit Select” to select the drum kit that you want to edit.
4. Use the Key parameter to select the note that you wish to edit.

GM drum kits 58 (GM)–66 (GM) cannot be selected here. (It is not possible to edit or write a GM drum kit.)

If you wish to modify the settings of one of the drum kits 58 (GM)–66 (GM), you can use **Copy Drum Kit** function to copy it to 00 (INT)–57 (USER), and then edit the copy.

5. Use the Assign check box to specify whether the key will have its own settings, or use the same settings as the next higher note.

If **Assign** is checked, the key will have its own settings. This is the default.

If **Assign** is not checked, the key won't have its own settings. Instead, it will use the same settings as the next higher note—except that the drumsamples will be played at a lower pitch. The amount of pitch change depends on the **Pitch Slope** parameter, on the P-PITCH> BASIC page.

Use this setting when you want only to change the pitch, such as with tom or cymbal sounds.

**Tip:** If you want to copy the settings of one key to a different drum sample, use the Copy Key Setup function.

### Velocity crossfade settings

For this key, let's create a simple velocity crossfade between two stereo drumsamples.

1. In the DRUM KIT> DS 1 and DS 2 pages, turn Drumsample 1 and 2 on.

If it is off, select the button and press the ENTER button to turn it on.



2. In the same way, make sure that Drumsamples 3–4 are Off.
3. Select Stereo as the Bank for Drumsample1 and Drumsample2.

Drumsamples come in several types: **RomM** (ROM Mono) or **RomS** (ROM Stereo).

RomM (ROM Mono) are mono drumsamples, and RomS (ROM Stereo) are stereo drumsamples. Stereo drumsamples use twice as many voices as mono drumsamples.

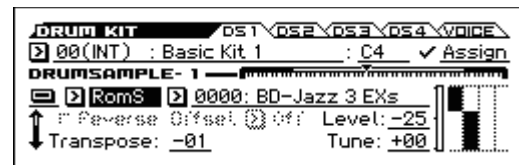

4. Select a drum sample. Select Drumsample 1, and press the ENTER button.

A list of drum samples organized by category will appear. Use the cursor buttons **◀▶** to view the list for other categories.

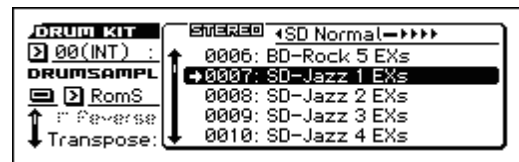

5. Use the cursor buttons to select a drum sample name from the list in the display.
6. Press the ENTER button to change the setting.
7. Switch to the DRUM KIT> DS 2 page, and specify Drumsample 2 in the same way.

Now that you've assigned Drumsamples to Drumsample1 and Drumsample2, let's set up the velocity ranges and crossfades.

8. For Drumsample 2, set Bottom Vel. to 1.

Turn Xfade Off.

Use the cursor button **▼** to scroll the page.



### 9. In the DRUM KIT> DS 1 page, set the Drumsample 1 Bottom Vel. to 80.

Now, Drumsample2 will sound when you play softly, at velocities of 79 or less—and Drumsample1 will sound when you play harder, with velocities of 80 or more.

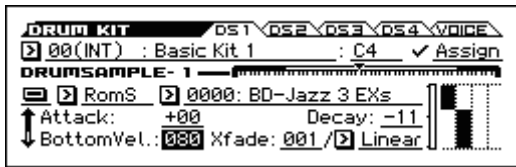

The meter to the left side of the Velocity Zone graphic indicates the note-on velocity value. This lets you verify the drumsample that will be sounded by a given velocity.

### 10. Next, set Drumsample1's Xfade to 20, and its Curve to Linear.

Notice that the graphic now shows the two ranges tapering into one another. Between 80 and 100, Drumsample2 will fade out, and Drumsample1 will fade in, creating a gradual velocity transition instead of a hard split.

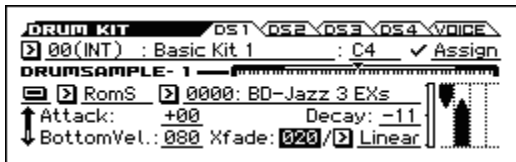

## Fine-tuning the sound of each sample

### 1. If you like, adjust the Levels for the two Drumsamples.

This can be very useful in creating a smooth velocity split or crossfade.

### 2. As necessary, specify the tuning, EG parameters, and filter.

For each drumsample, adjust the Tune, Attack (Amp EG Attack), Decay (Amp EG Decay), Cutoff, and Resonance.

## To link sounds such as hi-hat open and close

### 1. Access the DRUM KIT> VOICE page.

### 2. Use Excl (Exclusive) Group to assign the drumsamples to groups.

For example, by creating a group containing keys to which related drum samples such as hi-hat close and open are assigned, you can prevent an unnatural situation in which multiple types of hi-hat sound are heard simultaneously.

If closed hi-hat and open hi-hat are assigned to the same group, and you play the closed hi-hat while the previously played open hi-hat is still sounding, the open hi-hat sound stops, just as it would on an actual hi-hat.



## Sustaining the sound even after the key is released (Hold)

Use the **Hold** function for instruments that should continue sustaining even after the key is released, such as a crash cymbal. The way this works will depend on the settings of the program and drum kit.

Set the **Hold** function as follows.

1. Access the Program mode P-BASIC>NOTE-ON page.
2. Make sure that the Key Zone setting Hold is on.

Once you've turned on **Hold** for the Program, the function is controlled on a note-by-note basis according to settings within the Drum Kit.

### 3. Access the Global/Media mode DRUM KIT>VOICE page.

### 4. For each key, set the Note-Off (Enable Note-Off Receive) parameter as desired.

If this check box is not selected, notes will be held, and the sound will continue even after the key is released.

If it is checked, the key will not be held.

If you turn off **Hold** in the Program, no keys will be held - regardless of their **Note-Off (Enable Note-Off Receive)** setting.

## Controlling effects for each key

Drum Kits have their own, built-in mixers. For each key, you can control the Insert Effects bussing, Master Effects sends, and pan.

## Bus settings for each key

For example, you can change settings so that the snare is sent to IFX1, the kick to IFX2, and the other sounds to L/R.

### 1. Access the Program mode P-FX ROUTING> BUS page.

### 2. Make sure that the DKit-SET check-box is checked.

When Use **DKit Setting** is on, the Program will use the Bus Select and Effects Send settings for each key of the Drum Kit.

When Use **DKit Setting** is off, the Program will ignore the Drum Kit's Bus Select and Effects Send settings.

### 3. Access the Global/Media mode DRUM KIT> VOICE page.

### 4. Use the Bus Select parameter to send drum sounds through their own Insert effects, or to the L/R outputs.

If you like, you can send each note to its own Insert effect, or to the individual audio outputs, in addition to the L/R outputs.

**Tip:** In most preloaded drum kits, the drum instruments have the same **Bus (IFX/Output) Select** settings according to their type, as follows.

Snares → IFX1

Kicks → IFX2

Cymbals → IFX3

Toms, Percussions, other → IFX4

### 5. Use Send1 and Send2 to set the send levels to the master effects.

---

## Controlling pan for each key

To use separate pan settings for each key:

1. **Access the Program mode P-AMP> BASIC page.**
2. **Make sure that the DKIT-SET check-box is checked.**  
When **DKIT-SET** is on, the Program will use the pan settings for each key of the Drum Kit.
3. **Access the Global/Media mode DRUM KIT> VOICE page.**
4. Use “Pan” to specify the panning for each key.

---

## Saving Drum Kits

Once you’ve spent some time editing, you’ll want to save your work.

-  The contents of your editing in Global/Media mode are preserved as long as the power is on, but will be lost when you turn off the power. If you want to keep your edits, you must execute the **Write Drum Kits** function. This will save all drum kits.



# Overall settings for the KROSS, and saving/loading data

## How Global/Media mode is organized

By pressing the EXIT button ( **SHIFT** ) and the SEQ button( **GLOBAL/MEDIA** ), selects Global/Media mode.

In Global/Media mode, you can access the following settings and operations.

- Master tune
- Key transpose
- Effect global button
- Global MIDI channel
- Creating scales
- Damper pedal, assignable foot switch/pedal
- Creating user drum kits
- Creating user arpeggio patterns
- Save, load, and format an SD card
- Functions for managing additional PCM data

For details on how to access each page, please see “Basic operations” on page 12.

 The settings that you edit in the GLOBAL–DRUM KIT pages of Global/Media mode are preserved until you turn off the power, but will return to their previous settings when you turn off the power. If you want to keep these settings, you must write them into memory. You can also save them on an SD card. (see pages 124, 125)

 The Compare function that lets you return to the state prior to your editing (or undo edits) is not available in Global/Media mode.

## Global setting

For details on global setting, see Parameter Guide. (“Global/Media mode” on page 155 of the Parameter Guide)

### Basic settings for the KROSS

#### BASIC page

In the GLOBAL>BASIC page you can access settings for the KROSS's own keyboard.

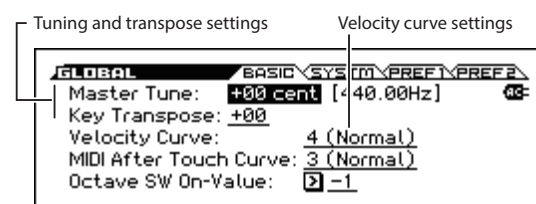

#### Tuning to another instrument

To adjust the tuning in fine increments, in order to match other instruments or recorded music:

- The GLOBAL> BASIC page Master Tune setting adjusts the pitch of the KROSS.

The **Master Tune** function is adjustable over a range of  $\pm 50$  cents (one semitone= 100 cents). When **Master Tune** is at 0, middle A is tuned to 440 Hz.

#### Transposing the keyboard

The pitch of the KROSS can be transposed in semitone steps. This is convenient when you want to change the key of the song without changing your fingering on the keyboard.

#### When playing the KROSS by itself

- Adjust the GLOBAL> BASIC page Key Transpose setting. The transposition range is up or down one octave in semitone steps.

#### When playing via MIDI

In addition to the Key Transpose setting described above, you can also change the G–MIDI>BASIC page Convert Position setting. By switching the Convert Position, you can specify whether the Key Transpose setting and the velocity curve setting (described below) will be applied to MIDI IN or MIDI OUT.

If you're using an external MIDI keyboard to play the sound generator of the KROSS, and want to transpose the pitch, set this to Post MIDI. The velocity curve will also apply to MIDI IN.

If you're using the keyboard of the KROSS to play an external MIDI sound module, and want to transpose the pitch, set this to Pre MIDI. The velocity curve will also apply to MIDI OUT.

## Changing how velocity will affect the volume and tone

Velocity curves let you adjust the way the KROSS responds to your playing dynamics on the keyboard. The default setting should work for most players, but there are many other choices to let you customize the response to match your own style.

- The GLOBAL> BASIC page Velocity Curve setting specifies how velocity will affect the volume and tone. Velocity Curve 4 is the default, and should work for most players. Curve 9 is designed specifically for playing piano sounds from the weighted NH keyboards in the 88-note models. (see “Velocity Curve” on page 156 of the Parameter Guide)
- Specify the position where the velocity curve will be applied. For more about “Convert Position,” please see “Transposing the keyboard,” above.

### Velocity curves

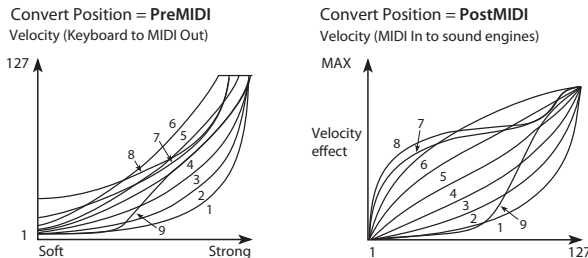

## SYSTEM (SYSTEM) page

In the GLOBAL>SYSTEM (SYSTEM) page you can access settings for the KROSS's effects and arpeggiator, and protect the memory.

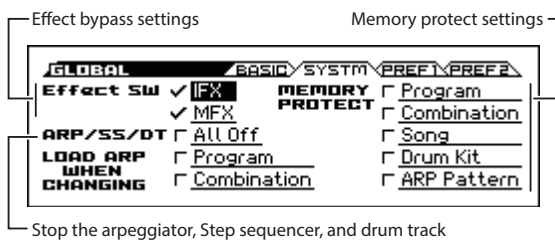

Stop the arpeggiator, Step sequencer, and drum track

## Bypassing the effects

You can bypass the KROSS's insert effects, and master effects. These settings will bypass the effects in all modes. If you're using effects such as reverb or chorus provided by an external effect processor, mixer, or DAW, you can bypass the KROSS's own effects so that they will not be used.

- The GLOBAL> SYSTEM (SYSTEM) page Effect SW setting bypasses the effects. If the check box is cleared, the effects will be bypassed.

Clearing the IFX box: Bypasses the insert effects

Clearing the MFX box: Bypasses the master effects

MFx can also be controlled using the front panel REALTIME CONTROLS. Press the SELECT button to select EFFECT, and use the SWITCH (MASTER FX) button to turn it on/off. This is a convenient way to temporarily turn off effects such as reverb while you perform.

**Note:** These parameters will always be turned on when the KROSS starts up.

## Arpeggiator recall settings (Linking the arpeggiator with programs or combinations)

You can specify whether the arpeggiator settings written into each program or combination will also be selected when you select that program or combination, or whether the arpeggiator will stay in its current state without changing settings.

With the factory settings, the former will occur. You can choose the latter behavior if you want to play phrases and patterns with certain arpeggiator settings while you switch only the sound between different programs or combinations.

- If the GLOBAL> SYSTM (SYSTEM) page LOAD ARP WHEN CHANGING check boxes are selected for Program and Combination, the arpeggiator settings that are written will be recalled when you switch programs and combinations respectively.

## Disabling the arpeggiator, Step sequencer, and drum track

- If the GLOBAL> SYSTM (SYSTEM) page ARP/SS/DT check box is selected, the arpeggiators, the step sequencer, and the Drum Track will be turned off.

Even if the ARP, RUN or DRUM TRACK buttons are on, the arpeggiator, Step Sequencer, and Drum Track will not function.

## Protecting the memory

The KROSS provides a memory protect setting that prohibits internal memory from being overwritten; this prevents the program, combination, song, drum kit, and user arpeggio pattern data from being modified unintentionally.

- To protect the contents of memory, you can select the various Memory Protect check boxes in the GLOBAL> SYSTM (SYSTEM) page to prohibit data from being written or loaded, or songs from being recorded.

## PREF 1 (Preferences 1) page

In the GLOBAL>PREF 1 (Preferences 1) page you can access settings for the KROSS's power.

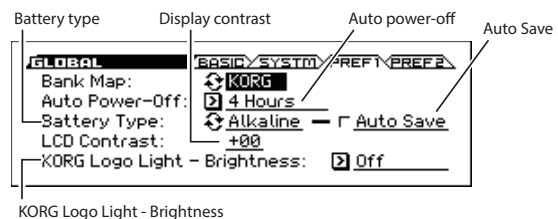

## Auto power-off

- The GLOBAL>PREF 1 (Preferences 1) page Auto Power-Off setting specifies the length of time after which the power will automatically turn off when there has been no user input on the KROSS for a specified amount of time. (see page 18)

## Battery type setting

In order for the remaining battery capacity to be correctly indicated, the type of battery in use should be specified.

- In the GLOBAL>PREF 1 (Preferences 1) page, use Battery Type to select the type of batteries you're using. Select Battery Type, and press the ENTER button to switch the setting.
  - Alkaline: Select when using alkaline batteries
  - Ni-MH: Select when using nickel-metal hydride batteries

## Auto-save setting

- In the GLOBAL>PREF 1 page, use the Auto Save check box to specify the power-conservation setting for when operating on batteries.
  - If this is On (checked), the brightness of the rear panel KORG logo illumination is decreased to save power only when operating on batteries. The default setting is On.

## Adjusting the display contrast

You can adjust the contrast of the display.

- Adjust the GLOBAL>PREF 1 (Preferences 1) page LCD Contrast setting.

**Tip:** In any mode, you can adjust the contrast by holding down the EXIT button ( **SHIFT** ) and turning the VALUE dial.

## KORG Logo Light - Brightness

This specifies the brightness of the rear panel KORG logo illumination. If this is Off, the logo is unlit.

- In the GLOBAL>PREF 1 page, set KORG Logo Light - Brightness to specify the setting.

## MIDI settings

In the G-MIDI> BASIC, OUT, and FILTER pages you can adjust overall MIDI settings that apply to the entire KROSS.

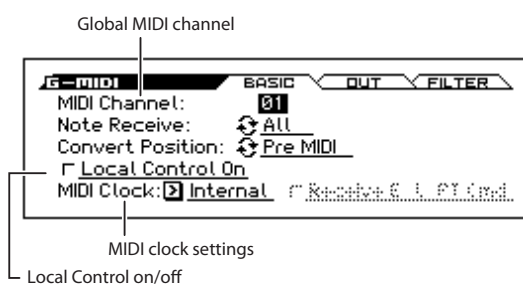

### Global MIDI channel

The global MIDI channel is the basic MIDI channel of the KROSS; keyboard and controller information is transmitted on this channel. The sound generator will produce sound mainly in response to receiving messages on this channel.

- This setting is specified by the G-MIDI> BASIC page MIDI Channel parameter.

### Local control

Local control specifies whether the keyboard and controllers will directly play and control the sound generator of the KROSS.

Turn local control on if you're playing the KROSS by itself, or if you're playing and controlling an external MIDI device unidirectionally while you play the KROSS.

If you have made connections and settings so that the performance data from the KROSS is being sent through an external MIDI device and returned back to the KROSS, such as when the KROSS is connected to a computer, turn local control off to prevent notes from being triggered in duplicate.

- This setting is specified by the G-MIDI> BASIC page Local Control On parameter.

## MIDI Clock synchronization

The KROSS can use its own internal tempo, or synchronize to external clocks from either MIDI or USB.

The best general-purpose setting is **Auto**. This combine the functionality of **Internal** and **External MIDI/USB**, so that you don't have to manually switch between the two:

If external clocks are being received, they control the KROSS tempo.

If external clocks are not being received, the KROSS uses its internal tempo instead.

- This setting is made by the G-MIDI> BASIC page MIDI Clock parameter.

If this is set to Ext-MIDI or Ext-USB, or is set to Auto and MIDI clock is being received, the PROG> MAIN page and similar pages will show ♩=EXT, and the tempo of the KROSS will be synchronized with the external MIDI device. In this case, you won't be able to change the tempo from the KROSS.

## Pedal and other controller settings

In the G-INPUT/CTRL> FOOT page you can assign foot controller functions and specify the polarity. (see "Connecting foot controllers" on page 23)

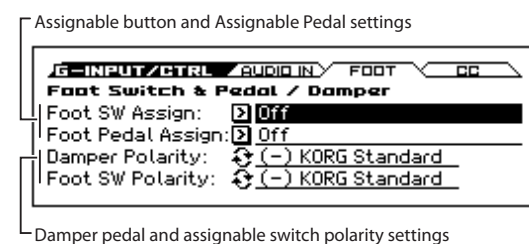

## Creating and selecting scales

You can create an original scale in the G-USER SCALES> OCTAVE and ALL pages. You can create sixteen User Octave Scales which allow you to specify the pitch of each note in an octave (which will then be applied across all octaves), and you can create one User All Note Scale which allows you to individually specify the pitch for every one of the 128 notes.

By adjusting the pitch of each key in the range of  $\pm 99$  cents, you can raise or lower it by approximately one semitone relative to the normal pitch.

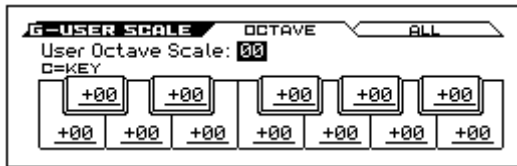

The user scales you create here can be used by specifying the scale for a program, for each timbre of a combination, or for each track of a song.

You can choose these scales from the following pages.

Mode	Page
Program	P-BASIC> SCALE: Scale Type
Combination	C-TIMBRE> SCALE: Scale Type, Use Program's Scale
Sequencer	S-TRACK> SCALE: Scale Type, Use Program's Scale

Here is how to set the scale type for each timbre in Sequencer mode.

**1. Create a user octave scale or a user all notes scale.**

Select a key, and use the VALUE dial to adjust the pitch. The range of  $\pm 99$  raises or lowers the pitch approximately one semitone above or below the standard pitch.

*Note:* You can also select the key by holding down the ENTER button and playing a note on the keyboard.

*Note:* You can copy one of the preset scales and edit it to create an original scale. To do so, use the **Copy Scale** function.

**2. Access the Sequencer mode S-TRACK> SCALE page.**

**3. Set “Scale Type (Song’s Scale)” to select the scale for the currently selected song.**

**4. If you want the Track to use the scale saved with its individual Program, check the track’s “Use Program’s Scale” check box.**

Tracks that are not checked will use the scale specified by Scale “Scale Type (Song’s Scale).”

# Data used by the KROSS

The KROSS accesses the following folders and files on the SD card.

## Folder and file structure (DOS files)

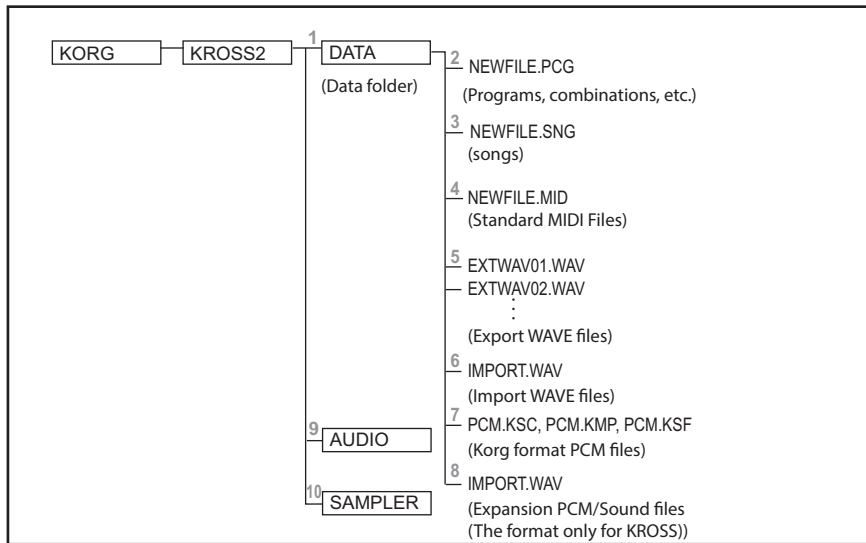

### 1. DATA folder

This is the folder that the KROSS uses to save/load data. Use the MEDIA> FILE page and UTIL page to work with these files.

-  You cannot create folders below the DATA folder. Folders created by a computer or other device will be ignored.

### 2. .PCG files

These files contain KROSS programs, combinations, drum kits, global settings, favorites data, and user arpeggio pattern data.

### 3. .SNG files

These files contain song data for the Sequencer mode of the KROSS.

### 4. .MID files

These files contain Sequencer mode songs that have been saved as Standard MIDI Files (SMF). Existing SMF data can also be loaded.

### 5. Export WAVE files

These files contain audio data that was recorded by the audio recorder or sampled by the pad sampler, and has been exported as WAVE files.

### 6. Import WAVE files

Existing WAVE files can be imported for use with the audio recorder or pad sampler.

Files of the following format can be exported and imported.

#### Export

File format: WAVE file

File bit depth: 16-bit

Sampling frequency: 48 kHz

Number of characters in file name: The first eight characters are shown (this can be renamed)

File name extension: .WAV

#### Import

File format: WAVE file

File bit depth: 16-bit

Sampling frequency: 44.1 kHz or 48 kHz, stereo files

Number of characters in file name: The first eight characters are shown

File name extension: .WAV

**Note:** Since 44.1 kHz WAVE files will be converted into 48 kHz as they are imported into the KROSS, a small amount of time may be required.

### 7. .KSC files, .KMP files, .KSF files

.KSC files are Korg Script files or Korg Sample Collection files; they manage Korg format PCM data. (Because of differences in the specifications of supported models, the name of these files may differ, but their basic functionality is the same.)

In the same way, .KMP (Korg Multisample Parameter) files support loading of multisamples, and .KSF (Korg Sample Parameter) files support loading of drum samples.

Sample data created by sampling-capable models such as the KRONOS, OASYS, M3, and TRITON can be loaded subject to the amount of available memory, and played. Data that was sampled by the pad sampler function can also be exported and loaded into a different sampling-capable model, and played.

### 8. .KEP files

.KEP (Korg EX PCM) files are files that manage option expansion PCM and sound data. These files include PCM data and sound data such as parameters and programs.

### 9. AUDIO folder

This folder contains system data and recording data for the audio recorder.

- Do not use your computer to modify this folder. The files and folders below this folder are only for the use of the audio recorder. Do not rename or modify them. Doing so will prevent the system from operating correctly.

### 10. SAMPLER folder

System data and recorded data for the pad sampler is saved here.

- Do not use your computer to modify this folder. The files and folders below this folder are only for the use of the pad sampler. Do not rename or modify them. Doing so will prevent the system from operating correctly.

### Files and data structures that the KROSS can recognize

The KROSS can load and save the following data.

Inside a file, .PCG data and .SNG data have the structure that's shown in the following illustration. When loading data, you can also select and load data individually.

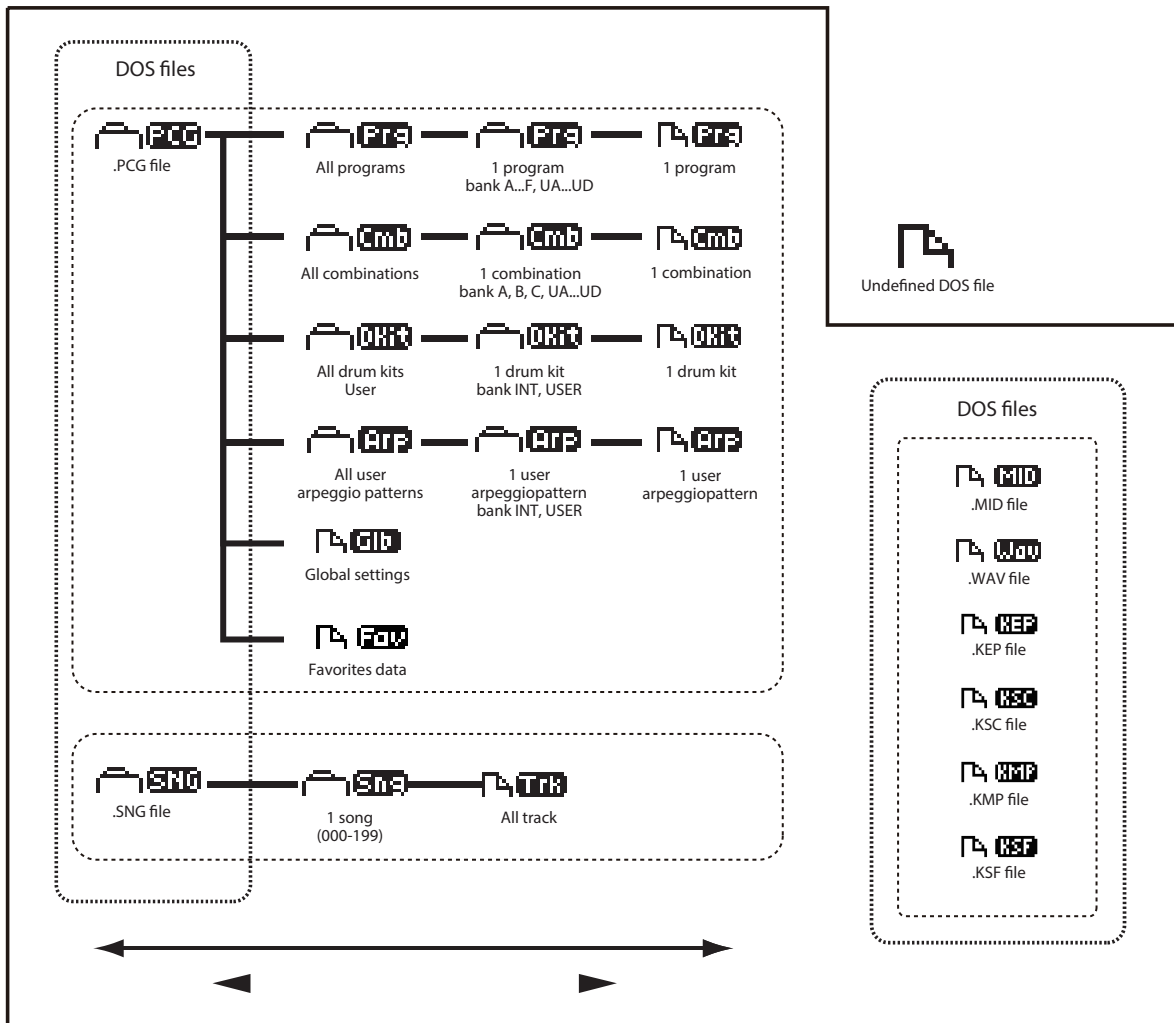

# Saving data

## Saving data on the KROSS

The KROSS can save .PCG, .SNG., or .MID files as follows.

**Note:** The explanation here applies to data in the DATA folder.

- Writing to internal memory
- Saving to an SD card (commercially available)
- MIDI data dump

### Writing to internal memory

The following types of data can be written into the internal memory.

- **Program**  
Programs 000–127 in banks A–F,  
User Programs 000–511 in banks UA-UD
- **Combination**  
Combinations 000–127 in banks A, B, C,  
User Programs 000–511 in banks UA-UD
- **Global settings**  
(GLOBAL> BASIC–G–USER SCALE> ALL)
- **Favorites data**  
banks A–H
- **User arpeggio patterns**  
0000–1279
- **User drum kits**  
00(INT)–57(USER)
- **User template songs U00–U15**  
Song settings such as the song name and tempo, track settings (see page 100 of the Parameter Guide), arpeggiator, and effect settings can be saved (written) to internal memory. However, the musical data for song tracks and patterns are not saved to internal memory. Furthermore, settings that govern how the musical data is played back such as **Time Sig (Time Signature)**, **Metronome**, **PLAY/MUTE**, and **Track Play Loop** (including Start/End) settings will not be saved either. Use the Sequencer mode function **Save Template Song** to write this data; for details, please see page 140 of the Parameter Guide.

 The musical data and setup data of a song you create in Sequencer mode cannot be saved in the KROSS's internal memory. You'll need to save this data to a commercially available SD card.

### About preloaded data and preset data

“Preloaded data” refers to the data that is loaded in the KROSS when it is shipped from the factory. You are free to rewrite this data, and with the exception of the demo songs, the data will be written to the location as described in “Writing to internal memory.”

You can reload the factory preload data into internal memory by using the Global/Media mode **Load Preload/Demo Data** function.

Preset data, on the other hand, is data that cannot be overwritten by the Write operation. This includes the following data.

- GM program banks GM, g(1)–g(9), g(d)

- GM drum kits 58(GM)–66(GM)
- Preset template songs P00–P15
- Preset Drum Track patterns/Preset patterns 001–772

### Bank numbers and conditions for saving

The bank and number indications show the numbers used for MIDI transmission and reception. Since the conditions for saving will differ depending on the bank as shown in the following table, this will provide a helpful guide.

With the factory settings, the program banks have the following contents.

#### Programs

Bank	Prog No.	Use	Explanation and conditions for saving
A	000...127	Preload programs	You can overwrite a bank/number that contains a sound of the same category. You can change the category if saving a new sound; it will be saved in user bank
B			
C			
D			
E			
F			
G	001...128	GM2 capital programs	256 programs and 9 drum programs complying with the GM2 sound map. Programs of these banks are read-only. They cannot be written.
g1...g9	001...128	GM2 variation programs	
gd	001...128	GM2 drum programs	
UA-UD	000...511	User/initial programs	User programs and initialized programs.

#### Combinations

Bank	Prog No.	Use	Explanation and conditions for saving
A	000...127	Preload combinations	You can overwrite a bank/number that contains a sound of the same category. You can change the category if saving a new sound; it will be saved in user bank.
B			
C			
UA-UD	000...511	User/initial combinations	User combinations and initialized combinations.

### Saving to SD card

The following data can be saved to an SD card (commercially available) inserted in the KROSS's SD card slot.

Please see “Files and data structures that the KROSS can recognize” on page 120.

- **.PCG file:**  
Programs, Combinations, Drum kits, Global settings, and user arpeggio patterns
- **.SNG file:**  
Song
- **.MID file:**  
Saves a Sequencer mode song in Standard MIDI File (SMF) format.
- **.WAV file:**  
Exports an audio song or the pad sampler function's sample data in 48 kHz 16-bit format. (Execute the Export

function in the AUDIO RECORDER SETUP window or the SAMPLER SETUP window.)

- **.KSC file:**  
Exports the pad sampler function's sample data as a Korg-format PCM data file. (Execute the Export to KSC function in the SAMPLER SETUP window.)

## MIDI data dump

The KROSS can transmit the following types of data as a MIDI data dump; you can save this data on an external data filer or other device.

- Programs, combinations, drum kits, favorites data and global settings
- Song (Sequencer)
- User arpeggio pattern

For details, please see “Dump:” on page 178 of the Parameter Guide.

## Writing to internal memory

### Writing a Program or Combination

#### Writing (saving) procedure

The Program and Combination settings you've made in the various editing pages can be saved to internal memory. This action is referred to as “writing a program” or “writing a Combination.” If you want your edited data to be preserved after the power is turned off, you must perform a Write operation.

- ▲ In order to write, you must first disable memory protect in Global/Media mode.(→ p.116)
- ▲ If you access the MEDIA page while audio data is being loaded at start-up or while the audio recorder is being used, the message “SD card busy” is displayed, and the functionality of that page will be unavailable. Either wait for the SD card access indicator to stop blinking, or stop the audio recorder.
- ▲ A combination does not contain the actual program data for each timbre, but simply references the number of the program used by each timbre. If you edit a program that is used by a combination, or exchange it with a different program number, the sound of the combination will also change, reflecting the altered program.

1. **Verify that the program or combination you want to save is selected.**
2. **Select the Write Program or Write Combination function. If you selected a user bank program or combination, the function will be Write/Initialize Program or Write/Initialize Combination.**

Press the FUNCTION button. Use the PAGE-(▲) button to select the above function, and then press the MENU (OK) button. A dialog box will appear.

*Note:* The conditions for saving will depend on the bank. (see “Bank numbers and conditions for saving” on page 121)

3. **The conditions for saving will differ depending on the bank of the program or combination you selected in step 1.**

**If you selected program bank A–F or combination bank A or B:**

If you specified Write, you can save the sound to the same category within bank A–F. The category is fixed.

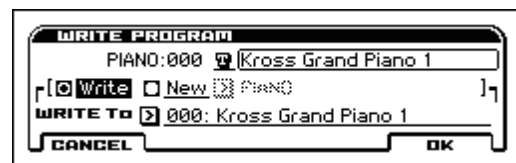

If you specified New, you can specify any category and save the sound in bank UA-UD 000–511.

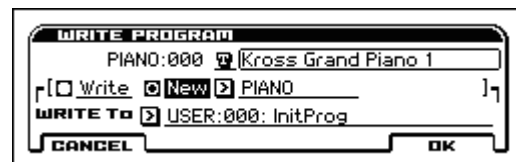



**If you selected program bank UA-UD or combination bank UA-UD:**

If you specified New, you can specify any category and save the sound in bank UA-UD 000–511.



*Note:* For more about Initialize, please see page 131.

4. Use **Category** to specify the category of the program/combination. For the banks that you can specify, please see step 3.
5. Select the save-destination in **WRITE To**. For limitations on the save-destination, please see step 3.
6. If you want to rename the program/combination, press the text edit button.

The text edit dialog box will appear. Enter the program/combination name. (see “Editing names” on page 124)

When you’ve finished entering the name, press the OK button to return to the Write Program/Write Combination dialog box.

7. To execute the Write operation, press the **MENU (OK)** button.

If you decide not to execute, press the **FUNCTION (CANCEL)** button or the **EXIT** button.

**About the Tone Adjust settings that are saved**

- Tone Adjust parameter controls two or more program parameters simultaneously. For example, “Filter/Amp EG Attack Time” controls a total of six program parameters. The value of a Tone Adjust parameter indicates the amount of change that is applied to the value of each program parameter it’s affecting. When a Tone Adjust parameter is at zero, the program parameters it controls will function according to their original settings. Raising or lowering the value of a relative parameter will indirectly raise or lower the value of these program parameters.

**Program mode:**

- The settings of Tone Adjust parameters are automatically applied directly to the program parameters when you write the program. The Tone Adjust values will be reset to zero.

For details, please see page 3 of the Parameter Guide.

**Combination mode:**

- The settings of Tone Adjust parameters are written and preserved as the Tone Adjust settings for each timbre.

For details, please see page 75 of the Parameter Guide.

**About the Program and Combination edit buffer**

When you select a program in **PROG> MAIN** or a combination in **COMBI> MAIN**, the program or combination data is called into the KROSS’s edit buffer.

When you then use the various Program or Combination pages to edit the parameters, your changes will affect the data in the edit buffer.

If you wish to save this modified data into internal memory, you must perform the Write operation.

When you perform the Write operation, the data in the edit buffer is written to the specified program or combination number of the specified bank.

If you select another program or combination without writing your edits, the data of the newly selected program or combination will overwrite the edited data in the edit buffer, and your changes will be lost.

*Note:* When you execute the COMPARE function in Program or Combination mode, the data from internal memory (the written content) will be temporarily called into the edit buffer. This allows you to compare the settings you are editing with the original un-edited settings.

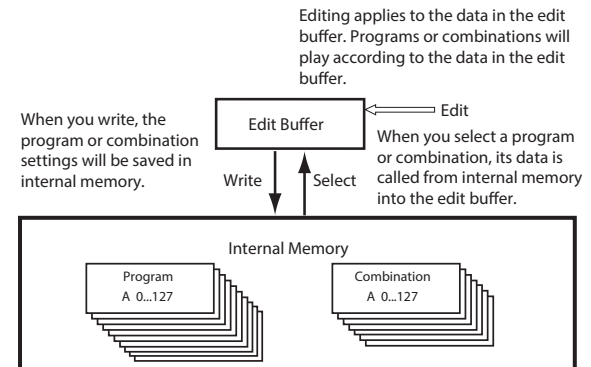

## Writing Global settings, User Drum Kits and User Arpeggio Patterns

### Memory in Global/Media mode

When the power is turned on, the Global/Media mode data is called from internal memory into the Global/Media mode memory area. Then when you modify the parameters in Global/Media mode, the data in the memory area will be modified. If you wish to save this modified data into internal memory, you must Write it.

When you write this data, the data in the memory area is written into internal memory.

If you turn off the power without writing, the modified data in the memory area will be lost.

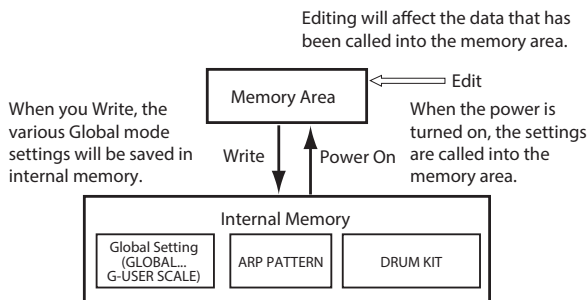

### Writing (saving) procedure

The following three types of Global/Media mode data can be saved by writing it into the KROSS's memory.

- Global settings (the settings in GLOBAL> BASIC - G-USER SCALE> ALL)
- Drum kits (the settings in ARP PATTERN> SETUP - ARP PATTERN> MODE)
- Arpeggio patterns (the settings in DRUM KIT> DS1 - DRUM KIT> VOICE)

Changes you make to this data will be remembered as long as the power remains on, but will be lost when you turn off the power. If you want to keep your changes even after turning the power off, you must write them into memory.

The following are exceptions.

Parameters that are not saved even if you Write

- Effect SW

1. Access the page that contains the parameters or settings that you want to save.

Choose one of the GLOBAL-G-USER SCALE pages if you want to write global settings, choose DRUM KIT pages if you want to write drum kits, or choose ARP PATTERN pages if you want to write arpeggio patterns.

2. Press the FUNCTION button located at the lower left of the display, and select Write Global Setting, Write Arpeggio Patterns, or Write Drum Kits. The respective dialog box will appear.

3. In the Write dialog box, press the MENU (OK) button.

If you decide not to execute, press the FUNCTION (CANCEL) button or the EXIT button.

## Editing names

You can modify the name of an edited program, combination, song, drum kit, or user arpeggio patterns etc.

These renaming procedures can be performed in the following pages.

Item	Page
Program	PROG...P-MFX function: Write Program
Combination	COMBI...C-MFX function: Write Combination
Song	SEQ...S-MFX (except for S-TRACK EDIT) function: Rename Song S-TRACK EDIT function: Rename Track
Arpeggio Pattern	ARP PATTERN function: Rename Arpeggio Pattern
Drum Kit	DRUM KIT function: Rename Drum Kit
File	MEDIA> FILE function: Save All...Save to Std MIDI File MEDIA> UTIL function: Rename, Format
Audio song	AUDIO RECORDER SETUP function: Create New Audio Song, Rename Audio Song, Export
Pad Sampler	EDIT SAMPLE function: Rename Sample

1. Select a function from the pages above, use the cursor buttons ◀▶▲▼ to select the text edit button , and press the ENTER button.

The text edit window will appear.

2. Use the cursor buttons PAGE- (◀) and PAGE+ (▶) to move the cursor.
3. Use the cursor buttons ◀▶▲▼ or the VALUE dial to select a character, and press the ENTER button to input that character.
4. Press the FUNCTION (SHIFT) button to switch characters.
5. If you hold down the FUNCTION (SHIFT) button, the three functions at the bottom of the display will become INSERT, DELETE, and SPACE (insert a space).

If you hold down the FUNCTION (SHIFT) button and press the ENTER button, a character will be inserted at the left of the cursor. Similarly, you can hold down the FUNCTION (SHIFT) button and press PAGE- (DELETE) to delete the character at the cursor location, or press PAGE+ (SPACE) to insert a space at the cursor location.

6. Press the MENU (OK) button to confirm. If you decide to discard the changes, press the EXIT button.

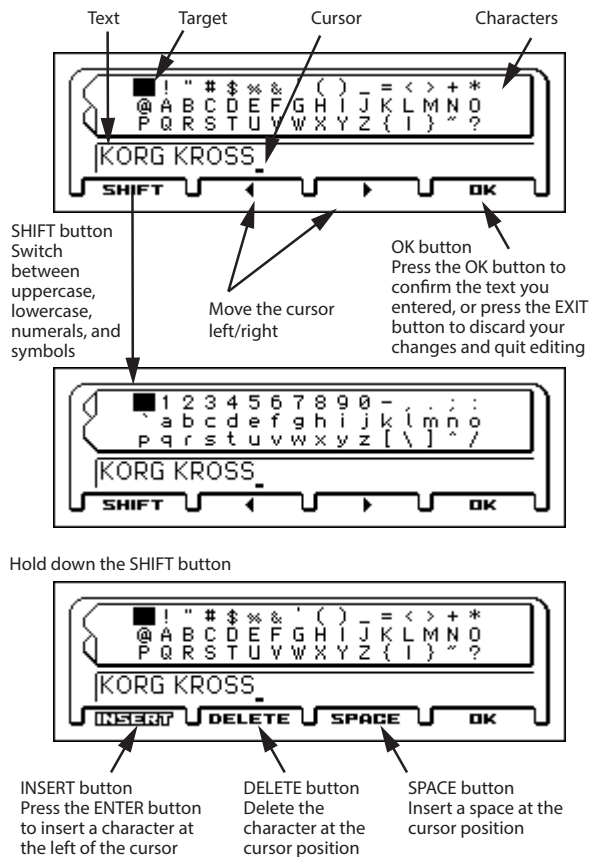

## Saving to SD card

For details on the data that can be saved on SD card, please see “Data used by the KROSS” on page 119.

The musical data of a song that you create in Sequencer mode cannot be saved in the KROSS’s internal memory. You must save this data on a commercially available SD card, or save it using MIDI data dump. When you’ve come up with settings you like, it’s a good idea to save them, so that even if you subsequently edit those settings, you’ll always be able to reload the previous settings if desired.

For details on the SD cards that can be used, and on how to insert or remove the SD card in the card slot, please see “Using an SD card” on page 25.

## How to save data

Access the MEDIA> FILE page, and use a function command to select the data that will be saved on the SD card.

As an example here, we’ll execute **Save All** to save the .PCG and .SNG files.

“Save All” saves all internal memory Programs, Combinations, Favorites data, Global settings, Drum Kits, and User Arpeggio Patterns to media as a .PCG file. It also saves songs as a .SNG file.

This method is available only if the current directory is a DOS directory. Press the cursor button ◀ to move between levels.

If you access the MEDIA page while audio data is being loaded at start-up or while the audio recorder is being used, the message “SD card busy” is displayed, and the functionality of that page will be unavailable. Either wait for the SD card access indicator to stop blinking, or stop the audio recorder.

**1. Make sure that the SD card is in a state that allows saving.** (see “Inserting/removing an SD card” on page 25)

**2. Access the MEDIA> FILE page.**

Hold down the EXIT button (SHIFT) and press the SEQ button (GLOBAL/MEDIA). Use the PAGE+ and PAGE- buttons to access the MEDIA>FILE page.

*Note:* If the contents of another file are shown, press the cursor button ◀.

**3. Press the FUNCTION button to access the menu, use the PAGE- (▲) or PAGE+ (▼) buttons to select Save All, and then press the MENU (OK) button.**

A dialog box will appear.

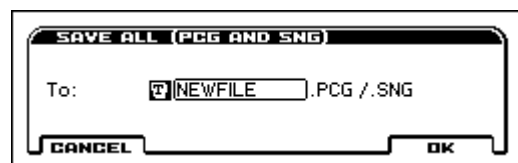

**4. Press the text edit button and input a filename for the file you want to save.** (see “Editing names”)

**5. Press the MENU (OK) button to execute the save function.**

The data will be saved on the SD card, and you will return to the Save page.

The display will show the file that was saved.

The various types of data are saved as the following files.

- .PCG file
- .SNG file

---

## Cautions when saving

### If an identically named file exists on the SD card

If a file with the same name already exists on the SD card, you will be asked whether you want to overwrite that data. If you wish to overwrite, press the MENU (OK) button. If you want to save without overwriting, press the FUNCTION (CANCEL) button and rename the file before you save it. For details, please see page 124.

## Loading data

---

### Data that can be loaded

---

#### Loading from SD card

You can load the following data from SD card.

- **.PCG files:**  
Programs, combinations, drum kits, global settings, favorites data, user arpeggio patterns
- **.SNG file:**  
Song
- **.MID file:**  
Standard MIDI file (SMF) format
- **.WAV files:**  
Import into the audio recorder or pad sampler (44.1 kHz/48 kHz, 16-bit, stereo files)
- Loading of .KSC and multisample data is supported

*Note:* For details on the SD cards that can be used, please see page 25.

---

#### Loading the preloaded data and demo songs

You can load the factory settings and demo songs back into the KROSS's internal memory. For the procedure, please see "Loading the preloaded data" on page 131.

---

### Loading data from SD card

---



#### Loading all Programs, Combinations, Drum Kits and Arpeggio patterns

Here we'll explain how to load all data from a .PCG file containing Programs, Combinations, Drum kits, Global settings, and User Arpeggio patterns in a single operation.

 Before loading this data, make sure that the Global/Media mode Memory Protect check box is cleared. (see "Protecting the memory" on page 116)

1. **Make sure that the SD card is in a state that allows loading.** (see "Inserting/removing an SD card" on page 25, "Automatic SD card loading at start-up" on page 25, "Saving to SD card" on page 121)

2. **Access the MEDIA> FILE page.**

Hold down the EXIT button (  ) and press the SEQ button (  ). Use the PAGE+ and PAGE- buttons to access the MEDIA>FILE page.

3. **Use the cursor buttons ▲ ▼ to select the .PCG file that contains the program or combination data that you want to load.**

*Note:* The .PCG files and .SNG files are at the top level. If you don't see them, press the cursor button ◀ to change levels. (see "Files and data structures that the KROSS can recognize" on page 120)

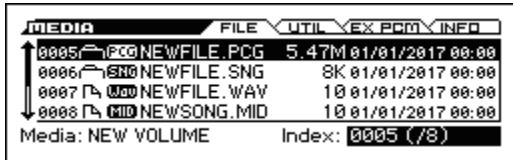

#### 4. Choose the Load selected function.

Press the FUNCTION button. Use the PAGE- (▲) button to choose Load selected, and then press the MENU (OK) button. A dialog box will appear.

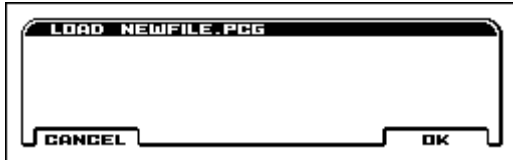

#### 5. Press the MENU (OK) button. All data from the .PCG file will be loaded into the KROSS.

⚠ Never remove the media while data is being loaded.

### Loading individual data from a .PCG file

The KROSS lets you load Programs, Combinations, Drum kits, User Arpeggio patterns individually or by individual banks.

⚠ Be aware that if you change the order of Programs, the sounds played by Combinations may also be affected.

As an example here, we will explain how a combination (A012) saved in bank A can be loaded into UA000.

#### 1. Select the combination that you want to load.

Use the cursor buttons ▲▼ to select a file, and press the cursor button ► to move to the next level.

[PCG] .PCG→[Cmb] Combinations→[Cmb] Bank A→[Cmb] 012



#### 2. Choose the Load selected function.

Press the FUNCTION button. Use the PAGE- (▲) button to choose Load selected, and then press the MENU (OK) button. A dialog box will appear.

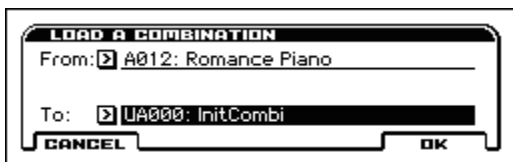

#### 3. Specify the load-source combination in the From section; and specify the load-destination combination (UA000) in the To section.

*Note:* The load-destination will be user bank.

#### 4. Press the MENU (OK) button to execute loading; the loaded combination will be assigned to UA000.

### Loading songs for use in Sequencer mode (.SNG)

As an example here, we will explain how to load a song.

*Tip:* If you want to use edited programs, drum kits, or user arpeggio patterns in a song, load those programs (i.e., .PCG file) after (or before) you load the song.

#### 1. Perform steps 1–3 under “Loading all Programs, Combinations, Drum Kits and Arpeggio patterns” on page 126. Select the .SNG file containing the data you want to load (it will be highlighted).

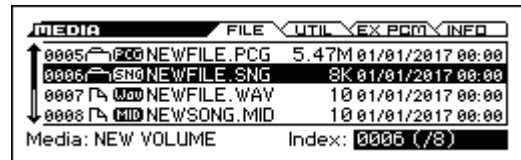

#### 2. Choose the Load selected function.

Press the FUNCTION button. Use the PAGE- (▲) button to choose Load selected, and then press the MENU (OK) button. A dialog box will appear.

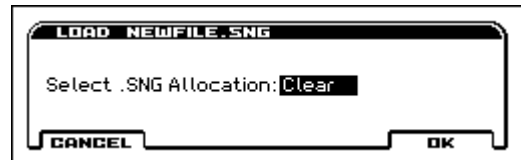

#### 3. Use “Select .SNG Allocation” to specify the destination where the song data will be loaded.

“Append” will load the song into the song number that follows the song(s) that currently exists in internal memory, without leaving a vacant number.

“Clear” will erase all songs from internal memory, and load the songs into the numbers from which they were saved.

#### 4. Press the MENU(OK) button to execute loading.

⚠ Never remove the media while data is being loaded.

## Loading a .KEP file

.KEP (Korg EX PCM) files are files that manage option expansion PCM and sound data.

These files include PCM data and sound data such as parameters and programs.

When you load a .KEP file, the PCM data is loaded into expansion sample memory. The parameter data is loaded into the user area of internal memory. The expansion sample memory has up to 128 MB of free space. (When calculated as 48 kHz, 16-bit linear data)

**1. As described in steps 1-3 of "Loading all programs, combinations, drum kits, and arpeggio patterns" (see page 126), select the .KEP file that contains the data you want to load.**

**2. Choose the Load Selected function.**

Press the FUNCTION button. Use the PAGE- (▲) button to choose Load Selected, and then press the MENU (OK) button. A dialog box appears.

**3. In Sound Data Allocation, specify how the sound data such as the programs and combinations will be loaded.**

**Append:** The data will be loaded into vacant locations.

**Clear:** The data will be loaded starting at the beginning of each user area.

**Manual:** The data will be loaded starting at the load destination that you individually specify.

**4. Press the MENU(OK) button if you want to execute, or press the FUNCTION(CANCEL) button if you decide not to execute.**

Once you load sample data, it remains in memory even after you turn off the power. If you want to remove previously loaded data from user sample memory, use the Unload PCM function in the EX-PCM page.

**Note:** The PCM data in a .KEP file is loaded into the free area of expansion memory. Loading will not be possible if there is not enough free area for the data to be loaded. You'll need to obtain the necessary amount of free memory by unloading the PCM data of a previously loaded .KEP file, and then loading again.

**Note:** Depending on the size of the PCM data in a .KEP file, loading might take a long time. Do not touch the switches or controls of the KROSS while data is being loaded. Never turn off the power of the KROSS during this time.

## Loading a .KSC file

.KSC (Korg Script or Korg Sample Collection) files are Korg-format PCM data files.

Sample data created by sampling-capable models such as the KRONOS series, OASYS, M3, and TRITON series can be loaded subject to the amount of available memory, and played.

.KSC files contain links to sample data, including multisamples, samples, and drum samples. When you load a .KSC file, the sample data, including the .KMP files and .KSF file linked to that file, are loaded.

**Note:** The Sampling mode data, .KMP file, and .KSF file listed in the .KSC file are saved in the directory of the same file name that is automatically created together with the .KSC file when saving. When you load a .KSC file, place the directory of the same file name in the same level as the .KSC file on the SD card.

When you load a .KSC file, the PCM data is loaded into expansion sample memory. The expansion sample memory has up to 128 MB of free space. (When calculated as 48 kHz, 16-bit linear data)?

**Note:** You can load a .KMP (Korg Multisample Parameter) file or .KSF (Korg Sample File) file into the KROSS, and play it. (See Load KSC, Load KMP, and Load KSF on Parameter Guide page 186.)

**1. As described in steps 1-3 of "Loading all programs, combinations, drum kits, and arpeggio patterns" (see page 126), select the .KSC file that contains the data you want to load.**

**2. Choose the Load Selected function.**

Press the FUNCTION button. Use the PAGE- (▲) button to choose Load Selected, and then press the MENU (OK) button. A dialog box appears.

**3. Press the MENU(OK) button if you want to load, or press the FUNCTION(CANCEL) button if you decide not to load.**

The data is loaded after the last-existing multisample and sample number. The multisamples and samples that are loaded at this time are packed so that only the actually-used samples are loaded (Append load).

Once you load sample data, it remains in memory even after you turn off the power. If you want to remove previously loaded data from user sample memory, use the Unload PCM function in the EX-PCM page.

**Note:** The PCM data in a .KSC file is loaded into the free area of expansion memory. Loading will not be possible if there is not enough free area for the data to be loaded. You'll need to obtain the necessary amount of free memory by unloading the PCM data of a previously loaded .KEP file, and then loading again.

**Note:** Depending on the size of the PCM data in a .KSC file, loading might take a long time. Do not touch the switches or controls of the KROSS while data is being loaded. Never turn off the power of the KROSS during this time.

# Media utility

## Formatting SD card

Newly purchased media or media that has been used by another device cannot be used “as is;” you must format the SD card before you can use it with the KROSS.

- ⚠ When you format the SD card, all data that had been saved on that media will be erased. Be sure to double-check the SD card for data before you format.
- ⚠ You must use the KROSS to format the media. The KROSS will not correctly recognize media that has been formatted by another device.

**1. Correctly insert the SD card to be formatted into the SD card slot.** (see “Inserting/removing an SD card” on page 25)

**2. Access the MEDIA> UTIL page.**

Hold down the EXIT button ( **SHIFT** ) and press the SEQ button ( **GLOBAL/MEDIA** ). Use the PAGE+ and PAGE- buttons to access the MEDIA> UTIL page.

**3. Select the Format function.**

Press the FUNCTION button. Use the PAGE+ ( **▼** ) button to select Format, and then press the MENU (OK) button. A dialog box will appear.



**4. Press the MENU (OK) button to format, or press the FUNCTION (CANCEL) button if you decide to cancel.**

When you press the MENU (OK) button, a message will ask you for confirmation. Press the MENU (OK) button once again to execute the Format operation.

- ⚠ Never remove an SD card from the slot while formatting is in progress.

## Setting the current time

Specify the date and time; this is used to record the correct date and time when you save data.

- ⚠ Since the KROSS does not contain a calendar or clock, you should use the Set Date/Time function to specify the date and time before saving, if necessary.

**1. Select the MEDIA> UTIL page Set Date/Time function.** (see steps 2 and 3 of “Formatting SD card”)

A dialog box will appear.

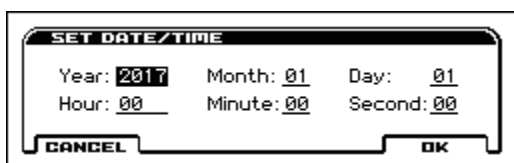

2. Use the VALUE dial to set the correct year, month, day, hour, minute, and second.
3. Press the MENU (OK) button.





# Appendices

## Restoring the factory settings

### Loading the preloaded data

The original preload data is backed up in the KROSS, so you can restore any or all of the Programs, Combinations, Drum Kits, User Arpeggio Patterns, and Global settings to their original factory settings.

**Note:** The original demo songs can be re-loaded at any time. For details, please see “About the data loaded by All Preload PCG”.

User banks and user patterns where preload data has not been loaded will remain unchanged. If you want to erase user banks or user patterns, initialize the KROSS and then load the preload data. For more details, please see “Initializing the system” on page 132.

- ⚠ Never turn off the power while the data is being loaded.
- ⚠ Before you load the preload data, go to the GLOBAL> SYSTM page, and uncheck the “Memory Protect” settings for the data that you want to load. If you execute this procedure with these settings checked, the data will not be loaded.
- ⚠ Loading the preloaded data will overwrite the contents of the internal memory. If you want to keep the existing data that is stored in internal memory, use “Save All (PCG&SNG)” or “Save PCG” to save your data to the SD card before you continue.
- ⚠ This cannot be used while the SD card's Automatic loading at start-up is in progress, nor while the audio recorder is recording or playing back.

#### 1. Access the GLOBAL> BASIC page.

Hold down the EXIT button ( **SHIFT** ) and press the SEQ button ( **GLOBAL/MEDIA** ) to enter Global/Media mode.

If the GLOBAL> BASIC page is not shown, press the EXIT button.

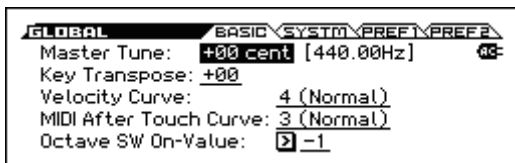

#### 2. Select the Load Preload/Demo Data function.

Press the FUNCTION button. Use the PAGE- (▲) and PAGE+ (▼) buttons to select Load Preload/Demo Data, and press the MENU (OK) button. A dialog box will appear.

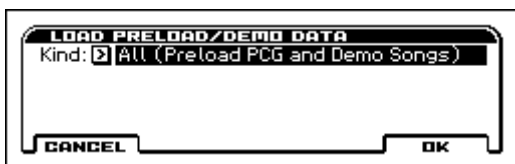

#### 3. As the Kind, use the VALUE dial etc. to choose All (Preload PCG and Demo Songs).

#### 4. Press the MENU (OK) button to load the preload data. If you decide not to load the preload data, press the FUNCTION (CANCEL) button.

When you press the MENU (OK) button, a dialog box will ask you for confirmation. Press the MENU (OK) button to execute loading.

### About the data loaded by All Preload PCG

When you execute All Preload PCG, the following data will be loaded:

- Program: Bank A, B, C, D, E, F
- Combination: Bank A, B, C
- Favorite bank: A, B, C, D
- Drum Kit: 00(INT)–51(INT)
- User Arpeggio Pattern: 0000–1023
- Global Setting

If you execute All (Preload PCG and Demo Songs), the demo songs will be loaded as well as the data above.

- Demo Song: S000–002

**Note:** As with the other user songs, the Demo Song data will not remain in Sequencer mode when you turn off the power. You'll need to load it again if necessary.

## Initializing the user bank

Here's how to initialize a program or combination in the user bank.

#### 1. Select the user bank program or combination that you want to initialize.

Use the CATEGORY dial to select the USER category, and use the VALUE dial to select the program or combination; then press the MENU button.

#### 2. Select the Write/Initialize Program or Write/Initialize Combination function.

Press the FUNCTION button. Use the PAGE- (▲) button to select the function above, and then press the MENU (OK) button. A dialog box will appear.



#### 3. Use the cursor buttons ◀▶▲▼ to select Initialize, and press the ENTER button.

#### 4. Use the cursor buttons ▼ to choose This/Bank/All, and press the ENTER button to select it.

This: Only the selected program or combination will be initialized.

Bank(UA...UD): Initializes the programs or combinations of the selected bank.

All: All programs or combinations in USER bank will be initialized.

5. To execute initialization, press the MENU (OK) button; if you decide not to execute, press the FUNCTION (CANCEL) button.

When you press the MENU (OK) button, a confirmation dialog box will appear; press the MENU (OK) button to execute initialization.

## Initializing the system

If operation becomes unstable, initializing the system may stabilize it.

1. Turn off the power of the KROSS.
2. Initialize the KROSS. While holding down the EXIT button ( **SHIFT** ) and FUNCTION button, turn on the power of the KROSS.

The KROSS will be initialized, and data will be written into internal memory. While the data is being processed, the display will indicate “Now writing into internal memory.” After initialization, you’ll need to load the preload data.

In Global/Media mode, execute the “Load Preload/Demo Data” function to load the data. (see page 131)

## Updating the system

You can update the KROSS’s system software by loading the most recent system file, which you can download to your computer from the Korg website (<http://www.korg.com>).

- Copy the system file onto an SD card, insert the SD card into the KROSS, go to the GLOBAL> BASIC page, and execute the Update System Software function.

For details on the procedure, please see the Korg website and “Update System Software” on page 177 of the Parameter Guide.

- ⚠ This cannot be used while the SD card's Automatic loading at start-up is in progress, nor while the audio recorder is recording or playing back.

## Troubleshooting

If you experience problems, please see the relevant item and take the appropriate measures.

### Power supply

#### Power does not turn on

- Is the AC adapter connected to an outlet? → p.17
- Did you hold down the power button for several seconds? → p.17
- Is there remaining capacity in the batteries? → p.19

#### Power won't turn off

- Did you hold down the power button for several seconds? → p.18

#### Power turns off

- Could the Auto Power-Off function be enabled? → p.18

### Problems at start-up

**After you turn the power on, nothing appears on the display, or the display is very dim or dark. The KROSS works correctly when you play the keyboard or perform other operations.**

- Adjust the display contrast by holding down the EXIT button ( **SHIFT** ) and turning the VALUE dial.  
You can also make adjustments using the GLOBAL> SYSTM (SYSTEM) page LCD Contrast setting. → p.117

**After you turn the power on, the contents of the display remain unchanged for a long time, and the KROSS does not work correctly when you play the keyboard or perform other operations.**

- It may be that the data on the SD card is damaged. Remove the SD card from the KROSS and start it up. If the KROSS starts up normally, don't use that SD card.
- It may be that the internal data of the KROSS is damaged. (Such a state can occur if writing to internal memory did not end successfully, for example if you powered-off the KROSS while a program or other data was being written to internal memory.)  
Initialize the KROSS system. →“Initializing the system”

**The message “SD card busy Please wait.” appears when you operate the AUDIO REC, SAMPLER ACTIVE/HOLD, or AUDIO PLAY ACTIVE button**

- The SD card's Automatic loading at start-up" is being executed as a background process. Wait until the SD card access indicator stops blinking.

**The MEDIA page shows the message "SD card busy Please wait."**

- The SD card's Automatic loading at start-up is being executed as a background process. Wait until the SD card access indicator stops blinking.

## Basic operation (screen and functions)

### Can't change modes or pages

- Could the sequencer be recording, playing, paused, or in the record-ready state?
- Could the function dialog box be displayed? You can't change modes while a function dialog box such as WRITE PROGRAM is open.

### Can't turn on the LAYER/SPLIT button

- Is Program mode selected? These functions can't be used outside of Program mode.

### In Combination, or Sequencer mode, you can't edit the value of Timbre/Track parameters such as MIDI Channel or Status

- Some parameters can't be edited while notes are playing, either locally or from MIDI. If the damper pedal is held down, or if its calibration is incorrect, notes may be sustaining even if they aren't audible.
  - Are you using a damper pedal with a polarity that does not match the **Damper Polarity** setting (G-INPUT/CTRL> FOOT page)? → p.23
  - In some cases, this problem can be solved by executing the **Half Damper Calibration** function (GLOBAL> BASIC page). → PG p.177

## Audio output

### No sound

- Are connections made correctly to your amp, mixer, or headphones? → p.21
- Is the connected amp or mixer powered-on, and is its volume raised?
- Is Local Control turned on?
  - In G-MIDI> BASIC, check the **Local Control On** checkbox. → p.117
- Could the VOLUME knob be turned all the way to the left? → p.2
- Is the Master Volume assigned to **Foot Pedal**, and is that pedal volume lowered? → p.24
- Could the program be muted? → p.32
- If a specific timbre does not sound in Combination mode, is the Sound setting set to Play? → p.48  
Are all of the Solo settings turned off? → p.48
- If a specific track does not sound in Sequencer mode, is the Sound setting set to Play? Are all of the Sound settings turned off? → p.57
- Make sure that the **Status** is INT or BTH. → p.51, 59
- Are the Key Zone and Velocity Zone set so that sound will be produced when you play? → PG p.8, 79, 118
- Are the Oscillator, Drum Track, Timbre, or Track levels lowered in the control surface mixer? → p.32, 48, 57
- Could the total polyphony be exceeding the maximum polyphony of 120 voices? → p.36

### Notes do not stop

- Is Hold (P-BASIC> NOTE-ON page) turned off? → PG p.9
- In G-INPUT/CTRL> FOOT, make sure that **Damper Polarity** or **Foot SW Polarity** is set correctly. → p.23
- If the DRUM TRACK or ARP buttons are turned on, try turning them off.

### Notes are sounded in duplicate

- Is Local Control turned Off?
  - Clear the **Local Control On** checkbox (G-MIDI> BASIC). → p.117

### Noise or oscillation is heard

- When you're applying an effect to an external audio input signal from the MIC IN jack or LINE in jack, unwanted oscillation (feedback) may occur depending on the type of effect or the parameter settings. If this occurs, adjust the external audio signal's input level, output level, or effect parameters. Take care especially when using high-gain effects.
- When using the MIDI/Tempo Sync function to control the delay time of an effect, noise may occur in the delay sound. This noise is due to discontinuities in the delay sound, and is not a malfunction.
- Some effects, such as S19: St. Analog Record, generate noise intentionally. It is also possible to create oscillation using a filter with resonance. These are not malfunctions.
- Note that if you use the following effects with the routing described below, a feedback loop will be created, possibly producing a loud noise. Please use caution.

If the signal from an oscillator or timbre/track output, or the signal after an insert effect, is sent to the FX Control bus and that signal is output directly, with this output sent to the FX Control bus, a loud noise may be output. (It is also possible that a DC component will be output at the maximum level, producing silence.)

- When using the S03: Stereo Limiter or S06: Stereo Gate, and the **Env Src** (Envelope Source) of these effects is set as either FX Control 1 or FX Control 2, and **Trigger Monitor** is On.
- When using D09: Vocoder, with the **Mod. Src** (Modulator Source) set to FX Control 1 or FX Control 2, and the **Mod. Hi Mix** (Modulator High Mix) set to other than 0.

### Can't play chords

- Could the program's **Voice Assign Mode** be set to Mono? → p.36

### Pitch is incorrect

- In the GLOBAL> BASIC page, are the **Master Tune** and **Key Transpose** settings correct? → p.115
- In the P-PITCH> BASIC page, is the **Pitch Slope** set to +1.0? → PG p.15
- In the combination or song, are the **Transpose** and **Detune** settings of each timbre/track set appropriately? → p.52 and PG p.117
- In the timbre/track settings of each program, combination, or song, could you have selected a non-standard scale type other than Equal Temperament? → p.52 and PG p.10, 78, 118

## Audio input

### Can't input audio

- Is the input source connected to the MIC IN jack or the LINE IN jack? → p.21
- In REALTIME CONTROLS, is the AUDIO IN 1 setting AUDIO IN turned on? → p.15
- Is the Line or Mic input selection correct?
  - Line and Mic cannot both be input simultaneously. In the AUDIO IN - QUICK SETTING dialog box, use the Select setting to choose either Line or Mic. → p.22
- Are the audio input parameters such as Level, Gain, Play/Mute, and Bus set appropriately?
  - In the AUDIO IN - QUICK SETTING dialog box, select Line or Mic and check the parameter settings. → p.22

The principal parameters have the following default values.

Level: 127

Play/Mute: Play

Gain: 00 (Line), 37 (Gain)

Bus: L/R

### Too much noise or distortion in the audio input or in the recorded sound

- Is the Gain set correctly?
  - In the AUDIO IN - QUICK SETTING dialog box, if the [LINE] or [MIC] indication in the middle of the level meter is highlighted, the Gain setting is too high, and an overload is occurring in the input stage. Lower the Gain value until this indication is not highlighted. → p.22
  - Conversely if the Gain setting is too low, the meter will not move very much. Adjust the Gain value upward. → p.22

## Programs and Combinations

### Settings for oscillator 2 are not displayed

- Make sure that the OSC (Oscillator Mode) (P-BASIC> BASIC) parameter is set to Double or Double Drums. → p.36

### Program does not sound

- Could the oscillator or amp level be lowered? → p.32, 37, 43
- Could the program be muted?
  - Switch the Sound in the PROG> MIXER page for a program, or in the COMBI> MIXER page for a combination.

### A combination does not play correctly after you load data

- Are the bank/numbers of the programs used by the combination the same as when the combination was created?

### Can't write a Program

- Is the Memory Protect **Program** or **Combination** checkbox (GLOBAL> SYSTM) cleared? → p.116
- Banks A–F and bank UA...UD have restrictions on the categories and banks that allow saving. → p.121

### A program selected for a timbre in a combination sounds

### different than when played in Program mode

- When you select a program for a timbre in Combination mode, the arpeggiator and effect settings from Program mode are not automatically applied.
  - You can use the Copy From Program, Copy Insert Effect, or Copy Master Effect functions to copy these settings from Program mode. → PG p.95, 96, 96

## Sequencer

### A program selected for a track sounds different than when played in Program mode

- When you select a program for a track in Sequencer mode, the arpeggiator and effect settings from Program mode are not automatically applied.
  - You can use the Copy From Program, Copy Insert Effect, or Copy Master Effect functions to copy these settings from Program mode. → PG p.139, 151, 151

### Song does not play correctly after being loaded

- Are the programs used by the song the same as when the song was created?
  - When saving the song, it is best to use **Save All (PCG&SNG)** so that the programs are saved together with the song. Then when loading, load both the .PCG and the .SEQ data. → p.127

### Playback does not start when you press the SEQUENCER ▶ / ■ (start/stop) button in Sequencer mode

- Is the **MIDI Clock** (G-MIDI> BASIC) set to Internal or Auto? → p.117

### Can't record in Sequencer mode

- Did you use **Track Select** to select the MIDI track that you want to record? → p.61
- Is the Memory Protect **Song** check box (GLOBAL> SYSTM) unchecked? → p.116
- Is the **MIDI Clock** (G-MIDI> BASIC) set to Internal or Auto? → p.117

### A combination copied using "Copy From Combination" doesn't record via arpeggiator as it did when you were playing it in Combination mode

- Is **Multi REC** (SEQ> MAIN) checked? → p.61 and PG p.108
- Are the settings in the Copy from Combination dialog box correct? → PG p.138
  - In the Copy from Combination dialog box, check the **Auto adjust Arp setting for Multi REC** option before you execute the copy. This will cause the settings to be adjusted automatically.

### Can't record Tone Adjust data

- Changes you make using Tone Adjust are recorded as system exclusive data. Did you check the G-MIDI> **FILTER Enable Exclusive** check box? → PG p.163

### SMF you loaded in Media mode won't play correctly

- Execute the **GM Initialize** function to restore the settings. → PG p.141
- Set **Bank Map** to GM(2) and load the data again. → PG p.158

## Arpeggiator

### The Arpeggiator does not start

- Is the ARP button turned on (lit)? → p.73
- If the arpeggiator does not start for a combination or song, make sure that **Run** is checked, and that an arpeggiator is selected for **Assign**. → p.76
- If the arpeggiator does not run in the ARP PATTERN> SETUP–MODE pages, could you have moved from Combination or Sequencer mode with settings that keep the arpeggiator from starting?
- Is the **MIDI Clock** (G-MIDI> BASIC) parameter set to Internal? → p.117
- In the GLOBAL> SYSTM page, is **ARP/SS/DT All Off** checked? → p.116

## Drum Track function

### The Drum Track does not start

- Is the DRUM TRACK button turned on (lit)? → p.83
- You pressed the DRUM TRACK button but the drum track pattern did not start.
  - Is the DRUM TRACK button blinking? **Trigger Mode** is set to Wait KBD Trigger. The drum track pattern will start when you play the keyboard or receive a note-on. → p.85
  - Did you select a pattern that does not contain data?
  - Could 000: Off be selected as the pattern? → p.83, 84
- If the drum track pattern fails to start in Combination mode, is the **Output** setting appropriate?
 

If the drum track pattern fails to start in Sequencer mode, are the **Input** and **Output** settings appropriate? → p.84, 86
- Is **MIDI Clock** (G-MIDI> BASIC) set to Internal or Auto? → p.117
- In the GLOBAL> SYSTM page, is **ARP/SS/DT All Off** checked? → p.116

## Drum Kits

### The drumsample's pitch does not change

- You have left the **Assign** check box unchecked, and want to play the drumsample at the adjacent right a semitone lower, but the pitch does not change.
- If you've selected a drum program in Program mode, and then want to use the Global/Media mode DRUM KIT page to edit the drum kit, you should use the P-PITCH> BASIC page to set Pitch Slope to +1.0 before you enter the DRUM KIT page. → p.15

## Effects

### Effects are not audible

- Have you selected effect program 000: No Effect ?
  - Select an effect other than 000: No Effect for “IFX1–5,” or “MFX 1, 2.”
- Are the Effect SW IFX and MFX check boxes (GLOBAL> SYSTM page) selected? → p.116
- If you are in Combination and Sequencer mode, and master effects are not audible when you raise the **Send1** or **Send2** of the timbre/track, does **Return 1** or **Return 2** from the master effect need to be raised? → PG p.93, 135
 

Alternatively, has **Send 1** or **Send 2** for each oscillator of the program used by the timbre/track been lowered? → PG p.91, 132

*Note:* The actual send level is determined by multiplying the send setting of each oscillator in the program with the send setting of the timbre/track.
- Have you routed the output to an insert effect? → p.68, 70 and PG p.216

### The program selected for a timbre/track in Combination or Sequencer mode sounds different than when played in Program mode

- When you select a program for a timbre/track in Combination or Sequencer mode, the arpeggiator and effect settings from Program mode are not automatically applied.
  - You can use the Copy From Program, Copy Insert Effect, or Copy Master Effect functions to copy these settings from Program mode. → PG p.95, 96, 96, → PG p.139, 151, 151

## Step sequencer

### When a favorite is selected, you can't save step sequencer settings

- This is normal. Access and save these settings in Program or Combination mode.

## Pad sampler

### Pressing a sampled pad produces no sound.

- Have you inserted the SD card that you used when sampling?
- Have you selected the bank A–H that you used when sampling?

### In Sequencer mode, the pad sampler performance is not recorded or played back.

- In the MAIN or PROG page, is the SMP(PAD SAMPLER On/Off) turned on? If this is on, the pad sampler performance can be recorded on track 15 as MIDI note-on/off messages, and played back.

**When you press the SAMPLER ACTIVE button, the message "SD card busy Please wait." appears**

- The SD card's "Automatic loading at start-up" is being executed as a background process. Wait until the SD card access indicator stops blinking.

---

## Audio recorder

**Can't record**

- Is the SD card inserted correctly? → p.25
- Could LOOP be turned on? You can't record if LOOP is on.

**The volume of imported data is too loud compared to the sound played by the KROSS or the external audio input**

- If the data is very loud, there may be a substantial volume difference. To temporarily adjust the playback volume of the audio recorder, use the Set Play Level function. If you want to overdub onto the imported audio, use the Adjust Audio Level function (instead of Set Play Level) to lower the volume of the entire audio song beforehand. → p.106

**When you overdub, the previous take becomes too quiet**

- Could Set Play Level be set to something other than 0 dB? Use the Adjust Audio Level function to adjust the volume of the entire audio song. → p.106
- Could Master Volume be assigned to Foot Pedal, and could that pedal be lowered? If you want to adjust the volume of the performance while you record, use Expression or Volume. → p.24

**When you press the AUDIO REC button or the AUDIO PLAY ACTIVE button, the message "SD card busy Please wait." appears**

- The SD card's "Automatic loading at start-up" is being executed as a background process. Wait until the SD card access indicator stops blinking.

**When you press the AUDIO REC button or press a pad when using the audio play function, the message "In MEDIA pages, the audio recorder is not available." appears**

- You can't operate the audio recorder while in the MEDIA page. Move to a different page.

---

## MIDI

**The KROSS does not respond to incoming MIDI data**

- Are all MIDI cables or USB cables connected correctly? → p.26
- Are the KROSS's receive settings (such as the global MIDI channel and the timbre/track's receive channel) set to match the channels of the transmitting device? → PG p.315

**The KROSS does not respond correctly to incoming MIDI data**

- Are the G-MIDI> FILTER settings MIDI Filter Enable Program Change, Enable Bank Change, Enable Control Change, Enable AfterTouch, and Enable Exclusive each checked? → PG p.163

- Does the KROSS support the types of messages that are being sent to it? → PG p.315

**Can't recall programs of the desired bank**

- Is the Bank Map setting correct? → PG p.158

---

## Damper pedal

**Damper response is wrong**

- Execute the Half Damper Calibration function (GLOBAL> BASIC) to correctly calibrate the half-damper pedal sensitivity. → PG p.177

---

## Media

**The message "SD card busy Please wait." appears**

- If the SD card access indicator is blinking, "Automatic loading at start-up" is being executed as a background process. Wait until the blinking stops. If the audio recorder indicator is blinking, the audio recorder is accessing the SD card. Stop the audio recorder.

**Can't format the SD card**

- Does the SD card meet the requirements for use on the KROSS? → p.25
- Is the SD card inserted correctly? → p.25
- Could the SD card's Lock (write protect) switch be on?

**Can't save/load data on the SD card**

- Is the SD card inserted correctly? → p.25
- Has the SD card been formatted? → p.129
- Could the SD card's Lock (write protect) switch be on?

**SD card is not recognized**

- The date of the saved file is incorrect.
  - Remove the SD card and check whether the card's contacts are dirty. If they are dirty, clean them gently with a dry cloth or a cotton swab.
  - \* Do not use liquids. Take care not to touch the contacts directly with your hands or with a metal object.

**The date of the data is wrong**

- The files you saved have the incorrect date.
  - The KROSS does not contain an internal calendar. Use the Set Date/Time function (MEDIA> UTIL page) to specify the current time and date before you save the data. → p.129

**Data that you saved from your computer to an SD card does not appear in MEDIA mode.**

- Copy the data to the KORG/KROSS2/DATA folder. This folder will be created when you use the KROSS to format the card. → p.119
- Is the file name extension format appropriate? → p.119

---

## Connections with a computer

**The KROSS does not respond to MIDI data sent from**

**outside**

- Is the USB cable connected correctly? → p.26

**The computer does not detect the KROSS**

- Are the USB cables connected correctly?

**An error occurs when you disconnect from the computer**

- Never disconnect the KROSS from the computer while your host application is in use.

**While connected, you are asked to install software or a device driver**

- Does the operating system or version of your computer support the KROSS?

**When using USB, sound processing is slow, or the tempo is unstable**

- Is the KORG USB-MIDI driver installed correctly?
  - You must install the dedicated Korg driver in order to use the KROSS via USB MIDI.
 

If your computer's operating system is Windows, you'll need to install the driver for each USB port where you connect the KROSS.

If you connect the KROSS to a different USB port than the one you used when installing the KORG USB-MIDI Driver for Windows, you'll need to reinstall the KORG USB MIDI driver.

**Your computer does not recognize an SD card that was formatted by the KROSS**

- Does the SD card reader support SDHC cards?

# Messages

## Error and confirmation messages

### A

**Aborted**

**Meaning:** Execution of the function was cancelled.

**Are you sure ?**

**Meaning:** This message asks you to confirm execution. To execute press the OK button. To cancel, press the CANCEL button.

**Audio recorder data error**

**Meaning:** An error occurred while managing the audio song recording data.

- No further recording is possible. Execute the Adjust Audio Level function with "Level:00dB" on the recorded data, and you'll switch to a new audio song so that you can continue recording.

**Audio song full**

**Meaning:** Another audio song cannot be created because there are already 200 audio songs.

- Switch to a different SD card.

**Auto Power-Off is enabled.****The system will automatically shut down after being idle for 30 minutes/1 hour/4 hours.**

**Meaning:** The auto power-off function is enabled. If the KROSS has not been played or operated for a specified length of time, the power will turn off automatically.

- If you want to disable this function or change the time setting, go to the GLOBAL> PREF 1 page and set the Auto Power-Off parameter. Use the Write Global Setting function to save the setting.

### C

**Can't calibrate**

**Meaning:** Calibration could not be performed correctly.

- Try again.

**Can't update system**

**Meaning:** Execution of the Update System Software operation did not end successfully.

- Try the operation again.

**Completed**

**Meaning:** The processing executed by the command has been completed.

**Completed. Please turn the power off, and then on again.**

**Meaning:** Execution of Update System Software has been completed successfully. Turn the power switch off, and then on again to complete the update.

## D

### Destination and source are identical

**Meaning:** When copying or bouncing, the same song, or track was selected for both the source and destination. To solve this problem:

- Select a different song, or track for the source and destination.

### Destination from-measure within the limits of source

**Meaning:** When executing the Move Measure command for all tracks or within the same track, the specified destination measure is within the source range. To solve this problem:

- Set a destination measure that is outside of the source range.

### Destination is empty

**Meaning:** When editing, the track that was specified as the destination contains no musical data. To solve this problem:

- Select a track that contains musical data.

### Destination measure is empty

**Meaning:** The measure that was specified as the destination contains no data.

- Specify a destination measure that contains data.

### Destination sample already exists. Overwrite?

**Meaning:** In the pad sampler function when using the Copy, Paste, or Import operations, a sample already exists at the destination (Paste or Import destination).

- Press the MENU (OK) button to overwrite. Press FUNCTION (CANCEL) button to cancel the operation.

### Destination song is empty

**Meaning:** The song that was specified as the copy destination or bounce destination does not exist.

- Execute the Create New Song command in the dialog box that appears when a new song is selected before copying or bouncing. (see page 60)

## E

### Effect size mismatch

**Meaning:** When copying or swapping effects, you attempted to place a double-size effect at IFX5 (insert effect 5) or MFX2 (master effect 2).

- Don't specify a double-size effect for IFX5 or MFX2 when executing the command.

### Effect type mismatch

**Meaning:** This message will appear when copying or swapping effects if the copy-destination or swap-destination IFX (insert effect), or MFX (master effect) has an effect that cannot be selected.

- For each IFX, and MFX, some effects can be selected and other effects cannot be selected. Verify that the effect is one that can be selected for the copy-destination or swap-destination IFX, or MFX.

### Error in formatting media

**Meaning:** An error occurred while formatting the media.

- Use other media.

### Error in reading from media

**Meaning:** An error occurred while reading data from media. This error may also appear when data is being written to media by a Save or Copy operation. To solve this problem:

- Execute the reading procedure once again. If the same error occurs, it is possible that the data on the media has been damaged.

### Error in writing to media

**Meaning:** A verification error occurred while writing data to a media. To solve this problem:

- It is possible that the media has been physically damaged. Try another media. Avoid using the media that produced the error.

## F

### File already exists

**Meaning:** When executing a **File Rename** procedure, a file of the same name already exists on the media.

- Either delete the existing file, or specify a different name.

### File contains unsupported data

**Meaning:** The WAVE, .KSF, or .KEP file that you are attempting to load is a format that is not supported by the KROSS.

- If possible, use a computer to convert the file to a format that the KROSS supports, and then load it.

### File is read-only protected

**Meaning:** You attempted to write or delete a file, but the file has a read-only attribute.

**Meaning:** You attempted to save a file with the same name as a read-only file that already exists on the media.

- Save the file with a different name.

**Meaning:** After using a computer etc. to lock the KORG folder, KROSS2 folder, or DATA folder, you then attempted to save using the Media mode of the KROSS.

- Use your computer etc. to unlock these folders.

### File unavailable

**Meaning:** The data from .KEP file is invalid. It is possible that the .KEP file from SD card has been damaged.

**Meaning:** You attempted to load or open a file whose file format is incorrect.

### File/path not found

**Meaning:** When operating the audio recorder, or when executing the Delete utility function of Media mode, the specified file did not exist.

**Meaning:** When loading a sample file in Media mode, the specified file does not exist; alternatively, the desired file name does not exist in the location that you choose in a dialog box that selects a different directory level or different media.

**Meaning:** In Media mode etc. when you used the Open button to open a directory, the path length including the name of the selected directory exceeded 76 characters.

- Check the file or directory.



**I****Illegal file description**

**Meaning:** You used an invalid file name when attempting to save or export a file.

- Change the filename you are specifying. Filenames not permitted by MS-DOS cannot be used as a filename.

**Illegal SMF data**

**Meaning:** You attempted to load a file that was not a Standard MIDI File.

**Illegal SMF division**

**Meaning:** You attempted to load a Standard MIDI File that was timecode-based.

**Illegal SMF format**

**Meaning:** You attempted to load a Standard MIDI File of a format other than 0 or 1.

**In MEDIA pages, the audio recorder is not available.**

**Meaning:** You can't operate the audio recorder while in the MEDIA page.

- Response: Move to a different page.

**M****Measure number over limit**

**Meaning:** The attempted edit procedure would cause the track length to exceed 999 measures.

- Delete unnecessary measures.

**Measure size over limit**

**Meaning:** When loading a Standard MIDI File, the number of events in a measure exceeded the maximum (approximately 65,535 events).

**Meaning:** The attempted edit procedure would cause the maximum number of events in a measure (approximately 65,535) to be exceeded.

To solve either of these problems:

- Use event editing etc. to delete unwanted data.

**Media busy**

**Meaning:** SD card access was not fast enough to keep up with recording or playback.

- As you repeatedly delete and write files, the file access efficiency may decline. In this case, you may be able to improve the situation by copying the KORG folder from the SD card to your computer, then formatting the SD card on the KROSS, and finally writing the KORG folder from your computer back to its original location. If this does not improve the situation, switch to a different SD card.

**Media not formatted**

**Meaning:** The media is unformatted.

- In the Media mode Utility page, execute the Format function on the media.

**Media unavailable**

**Meaning:** You selected a media source that does not allow writing.

**Media write protected**

**Meaning:** The audio recorder or Media mode is attempting to write data to media that is write-protected.

- Disable the write protect setting of the media, and execute the audio recorder operation or the command once again.

**Memory full**

**Meaning:** When editing a song, or track in Sequencer mode, the total data of all songs has used up all of the sequence data memory, and further editing is not possible. To solve this problem:

- Delete other song data etc. to regain free memory.

**Meaning:** While realtime recording in Sequencer mode, there is no more free memory to accommodate the recorded data, so recording has been forcibly halted. To solve this problem:

- Delete other song data etc. to regain the amount of free memory.

**Memory Protected**

**Meaning:** The internal program, combination, song, drum kit, user arpeggio pattern is protected.

- In Global/Media mode, turn off write-protect, and execute the write or load procedure once again.

**MIDI data receiving error**

**Meaning:** While receiving MIDI System Exclusive data, the format of the received data was invalid, for example, because the size of the data was incorrect.

**N****No data**

**Meaning:** When loading a Standard MIDI File, the file contained no events.

**No media**

**Meaning:** When using the audio recorder or when executing a Global/Media mode command, the target SD card was not inserted.

- Insert SD card, and navigate to an appropriate directory that the KROSS will recognize.

**No recording track specified**

**Meaning:** When performing realtime multi-track recording, you attempted to begin recording with no tracks set to REC. To solve this problem:

- Set the desired tracks for recording to REC.

**No space available on media**

**Meaning:** When saving or exporting a file, there was insufficient space on the media.

- Either delete an existing file, or replace the media with another that contains sufficient free space.

**No updating was required at this time. The KROSS already has the latest version of the system files.**

**Meaning:** When executing the Global/Media mode Update System Software function, the update was not necessary because the system is already the most recent version.

**Not enough memory**

**Meaning:** When starting realtime recording in Sequencer mode, the minimum amount of free memory (such as memory for the BAR events up to the recording start location) could not be allocated. To solve this problem:

- Delete other song data etc. to regain free memory.

### Not enough memory to load

**Meaning:** When you attempted to load a .SNG file or a standard MIDI file in Media mode, there was insufficient free memory in the sequence memory. To solve this problem:

- Delete other song data etc. to regain free memory.

### Not enough sample memory

**Meaning:** There is insufficient sample memory (for the sample parameters or sample waveform data).

- Delete some samples to increase the amount of free memory.
- In the Media mode EX-PCM page, uninstall installed option titles or user sample data.

### Not enough session locations available

**Meaning:** When executing Create New Session, there is insufficient session memory. (The number of sessions has exceeded the maximum of 200.)

- Execute the function in a way that overwrites an unneeded session.

### Not enough song locations available

**Meaning:** When loading a .SNG file with **Append** specified, you attempted to load more songs than can be loaded.

- In Sequencer mode, execute **Delete Song** to increase the number of songs that can be used, and then load the song again.

**NOTICE: Overdubbing with this Level setting will attenuate the sections of previous takes by the same amount. Use ADJ.LVL to adjust the Audio Song and avoid uneven audio levels.**

**Meaning:** This message is shown if the audio recorder Set Play Level function is set to a value other than 0 dB.

- With this Level setting, if you overdub a region of the song while playing back the previous take, the volume of the previous take will be lowered only for the recorded region. To avoid this problem of lowered volume, use ADJ. LVL to adjust the audio song level.

### Now writing into internal memory

**Meaning:** Now writing to internal memory. Never turn off the power while this message is shown. Doing so may cause internal data to be damaged.

## R

### Root directory is full

**Meaning:** When attempting to create a file or directory at the root level of the media, you exceeded the maximum number of files or folder that could be created in the root directory of that media.

- Delete unneeded files from the root level of the media.

## S

### Sample length is shorter than minimum

**Meaning:** When using the pad sampler function, you attempted to execute an edit that would have caused the sample data length to be shorter than 8 samples.

- Specify the edit region etc. so that the sample data length is 8 samples or longer.

### Scanning media

**Meaning:** Now checking the contents of the SD card. Do not remove the card while this message is shown.

### SD card busy

#### Please stop the audio recorder.

**Meaning:** The audio recorder is accessing the SD card.

- If the audio recorder is operating, stop the audio recorder.

### SD card busy

#### Please wait.

**Meaning:** The SD card's "Automatic loading at start-up" function or some other function is accessing the SD card or the internal memory.

- If the SD card access indicator is blinking, wait until it stops blinking.

### Selected file/path is not correct.

**Meaning:** When loading a .KSF file that was saved in divided form across multiple sets of media, the order in which you attempted to load the files was incorrect.

- Load the .KSF files in the correct order.

### Source audio song setting is empty

**Meaning:** When using the pad audio play function, and executing Insert or Paste, the copy-source audio song settings were empty.

- Execute the Copy command before you execute Insert or Paste.

### Source is empty

**Meaning:** No data exists in the track that you specified as the source.

- Specify a track that contains musical data.

**Meaning:** The export-source audio song does not contain data.

- Specify an audio song that has been recorded.

### Source sample is empty

**Meaning:** When using the pad sampler function, and executing Insert or Paste, the source sample was empty.

- Execute the Copy command before you execute Insert or Paste.

**Meaning:** When using Export to KSC / Export to WAV to export, the export-source sample does not exist.

- Select a valid sample.

### Source timbre is not available

**Meaning:** When executing the Copy Step Seq function, the selected copy-source is a combination or song whose "STEP" check box is not selected. In this case, the step sequencer's pattern settings etc. will be copied, but the program settings of timbre 16/track 16 will not be copied.

- Select the "STEP" check box of the copy-source combination or song.

### System warning

**The internal memory has been corrupted, likely due to an interruption of power while the system was writing/saving data. This has been repaired and the affected Bank has been initialized.**

**Meaning:** A memory write procedure did not end normally, perhaps because the power was turned off while processing

was still underway after you wrote a program or other data into internal memory.

- The KROSS will automatically initialize itself in order to repair the internal memory. This message will appear at this time; press MENU(OK) button to close the dialog box. In some cases, the preload bank data may be temporarily initialized. As necessary, use the Global/Media mode Load Preload/Demo Data command to load the preload data into internal memory, or if you have your own backup PCG, load it using Media mode.

## T

### There is no readable data

**Meaning:** Either the file size is 0 or the file does not contain data that can be accessed by the load or open procedure. Alternatively, the data is damaged etc., and cannot be loaded or accessed.

### The SD card is busy. Please stop the audio recorder and try again.

**Meaning:** The audio recorder is accessing the SD card.

- If the audio recorder is operating, stop the audio recorder.

### The SD card is busy. Please wait until the current operation is complete.

**Meaning:** The SD card's "Automatic loading at start-up" function or some other function is accessing the SD card or the internal memory.

- If the SD card access indicator is blinking, wait until it stops blinking.

### The song exists, and will be initialized

**Meaning:** When executing the Sequencer mode Create New Song function, you attempted to create a new song for a song number that already exists. If you execute, the song will be initialized, and a new song will be created and overwritten onto it.

- If you don't want to initialize the currently-existing song, specify a new song number.

### The system has been idle for more than \*\*\*\* and will shut down in:

#### You can change the Auto Power-Off setting on the following page: GLOBAL - PREF 1

**Meaning:** If there has been no operation for the specified length of time of time, the Auto Power Off function will display a message informing you that the power will turn off soon. The power will turn off when the countdown time indication reaches zero.

- If you want to continue using the KROSS, press a key or switch. Auto Power Off will be reset, and the same message will appear when the specified length of time has once again elapsed without any operation.
- If you want to disable this function or change the time setting, go to the GLOBAL> PREF 1 page and set the Auto Power-Off parameter. Use the Write Global Setting function to save the setting.

### This title is already loaded

- You attempted to load a EX-PCM option title that had already been loaded.

## U

### Unable to save file.

**Meaning:** In Media mode when you save a file, the path length including the name of the selected directory exceeded 76 characters.

## Y

### You can't undo last operation. Are you sure?

**Meaning:** Once you enter event editing (even if you leave event editing without actually editing an event), it will no longer be possible to execute Compare to listen to the previous edit. If you wish to enter event editing, press the MENU (OK) button. To cancel, press the FUNCTION (CANCEL) button.

### You can't undo this operation. Are you sure?

**Meaning:** When you exit recording or event editing in Sequencer mode, the memory area for Undo (Compare function) is not allocated. If you wish to keep the data that was just recorded or edited, press the MENU (OK) button. If you wish to return to the previous data (i.e., to delete the data that was just recorded or edited), press the FUNCTION (CANCEL) button.

**Meaning:** When editing in Sequencer mode, memory area for Undo (Compare function) cannot be allocated. If you wish to execute the edit, press the MENU (OK) button (It will not be possible to undo your edit). If you decide not to execute the edit, press the FUNCTION (CANCEL) button.

- In order to allocate memory area for Undo (Compare function), delete unneeded data such as songs, or tracks. We recommend that you data to media before you execute the edit procedure.

### You can use "Quick Setting" with [EXIT]+[ENTER]

**Meaning:** In the Audio In page of Program, Combination, or Sequencer modes, this is shown at the bottom of the screen when the G-SET check box On setting is selected. At this time, the Audio In settings use the settings of the Global/Media mode G-INPUT/CTRL>AUDIO IN page. To apply these settings easily, hold down the EXIT button and press the ENTER button to open the Audio In - Quick Setting dialog box for G-SET.

# Specifications

Operating temperature	+10 – +40 °C		
Keyboard	KROSS2-61	61 keys (velocity sensitive; aftertouch not supported) Normally C2–C7 (adjustable in the range [C1...C6]–[C3...C8])	
	KROSS2-88	88 keys NH (Natural weighted hammer action) keyboard (no aftertouch) Normally A0–C8 (adjustable in the range [A-1...C7]–[A1...C9]) * The NH keyboard delivers a playing feel similar to that of an acoustic piano, with low notes being heavier and high notes being lighter.	
System	EDS-i (Enhanced Definition Synthesis - integrated)		
Sound Engine	Maximum Polyphony	120 voices (120 oscillators), single mode 60 voices (60 oscillators), single mode * The actual maximum polyphony will vary depending on oscillator settings such as stereo multisamples and velocity crossfading.	
	Preset PCM memory	Approximately 112 MB (calculated as 48 kHz / 16-bit linear PCM data equivalent) 496 multisamples (including seven stereo), 1014 drumsamples (including 49 stereo)	
	Expansion PCM memory	Approximately 128MB (*when converted to 48 kHz 16-bit linear PCM) * Used to load option PCM (file name extension .KEP) or Korg-format PCM data files (file name extension .KSC), etc.	
	Programs	Oscillator	OSC1 (Single), OSC1+2 (Double): Stereo multisamples are supported 4 velocity zones per oscillator, with switching, crossfades and layers.
		Filters	Four types of filter routing (single, serial, parallel, 24 dB) Two multi-mode filters per voice (low pass, high pass, band pass, band reject)
		Modulation	For each voice, two envelope generators (Filter & Amp), two LFOs, two key tracking generators (Filter & Amp), and two AMS mixers In addition, pitch EG, common LFO, and two common key tracking generators
	Combinations	Timbres	Up to 16 timbres, switchable via key zone or velocity zone, layer and crossfade supported, Tone Adjust function allows program settings to be offset
		Master Keyboard functionality	These allow you to control external MIDI devices
	Drum Kits	Stereo and mono drumsamples. 4-way velocity switches with crossfades and adjustable crossfade shapes (Linear, Power, Layer).	
	The number of ... -Combinations -Programs -Drum Kits	User Combinations	896 Combinations (384 Preload)
		User Programs	1280 Programs (768 Preload)
		User Drum Kits	58 Drum Kits (42 Preload)
		Preset Programs	265 Programs (256 GM2 Programs + 9 GM2 Drum Programs)
Favorites	Number of memories	128 (16 favorites × 8 banks)	
Effects	5 Insert Effects	In-line processing; stereo in - stereo out.	
	2 Master Effects	Two effects sends; stereo in - stereo out.	
	Effects types	Total of 134 types (select from 74 types for insert effects, 101 types of master effect 1, and 120 types for master effect 2)	
	Modulation	Dynamic Modulation	
	Effects Control Bus	Stereo side-chaining for limiter, gates, vocoders, etc.	
Polyphonic arpeggiators	Program mode: one arpeggiator available. Combination and Sequencer modes: two arpeggiators available.		
	5 preset arpeggio patterns (UP, DOWN, ALT1, ALT2, RANDOM)		
	1280 user arpeggio patterns (1024 preload) Number of tones: 12 tones, Number of steps: up to 64 steps		
Step sequencer	Program mode Combination mode Sequencer mode	One unit, Number of tones: 12 tones + 1 accent tone, Number of steps: up to 64 steps * Can be created for each program, combination, and song	
Drum Track	Preset patterns	772 patterns (Held in common with sequencer patterns.)	
Sequencer	Trigger Mode / Sync / Zone settings can be specified		
	16 MIDI Tracks		
	128 Songs		
	Resolution: 480 ppq (parts per ♩)		
	Tempo: 40.00–300.00 bpm (1/100 bpm resolution)		
	Up to 210,000 MIDI events		
	Counter	Measure/Beat/Tick	
	16 preset/16 user template songs		
Preset Patterns	772 patterns (Held in common with Drum Track patterns.)		
Format	Korg (KROSS) format, SMF (formats 0 and 1) supported		

Pad sampler	16pads x 8banks Automatically saved to and loaded from SD card Up to four pads can play simultaneously			
	Recording format	PCM audio format (48 kHz/16-bit)		
	Recording time	Maximum stereo sample is approximately 14 seconds for each pad		
	Import	WAVE format (file name extension .wav) 44.1 kHz/16-bit, 48 kHz/16-bit, stereo * 44.1 kHz is automatically converted to 48 kHz		
	Export	Korg-format PCM data file format (file name extension .KSC) WAVE format (file name extension .WAV) 48 kHz / 16-bit, stereo		
	Edit	Waveform display editing functions, settings such as start address and loop, editing functions such as normalize		
Audio recorder	Recording format	Audio format: PCM audio format (48 kHz/16-bit)		
	Import	WAVE format (file name extension .wav) 44.1 kHz/16-bit, 48 kHz/16-bit, stereo * 44.1 kHz is automatically converted to 48 kHz		
	Export	WAVE format (file name extension .wav) 48 kHz/16-bit, stereo		
	Recording time	Continuous recording time: maximum 3 hours Total recording time: depends on the SD card used (approximately 90 minutes per 1GB)		
	Number of songs	Maximum 200 songs		
	Number of overdub recording passes	Depends on the remaining capacity of the SD card		
	Counter	Hour/Min/Sec		
Pad audio play	16 pads x 8banks Direct playback of data from SD card Multiple pads cannot play simultaneously			
Media	File, Utility, Information, Functions for managing additional PCM data			
Controllers	Pitch bend wheel, Modulation wheel, SW1, 2			
	REALTIME CONTROLS	SELECT button, SWITCH button, KNOB1 knob, KNOB2 knob		
	Step sequencer / Favorites / Pad Sampler / Pad Audio Play	Pads 1–16 STEP SEQ ACTIVE button, RUN buttons, FAVORITES ACTIVE button, SAMPLER ACTIVE button, HOLD button, AUDIO PLAY ACTIVE button, BANK SELECT button LED: A/B/C/D/E/F/G/H (also used by STEP SEQ, FAVORITES, SAMPLER and AUDIO PLAY)		
	Drum Track	Buttons = DRUM TRACK		
	Arpeggiator	Buttons = ARP		
	Audio recorder	PLAY/PAUSE (▶/⏸) button (SETUP)		
	User Interface	Display	240 x 64 pixel LCD (backlit) Adjustable contrast (EXIT button + VALUE dial)	
Category		CATEGORY dial, VALUE dial		
MODE		Buttons = COMBI, PROG, SEQ (GLOBAL/MEDIA)		
Value controller		VALUE dial, cursor buttons ◀▶▲▼, EXIT, ENTER, FUNCTION, PAGE-, PAGE+, MENU buttons		
SEQUENCER		Buttons = ● (REC), ▶/■ (START/STOP)		
Quick layer/split		LAYER/SPLIT button		
Other		VOLUME knob		
Control Inputs	DAMPER (Supports piano-style half-damper pedals as well as standard foot switches)			
	ASSIGNABLE SWITCH, ASSIGNABLE PEDAL			
Audio Outputs (Analog)	AUDIO OUTPUT L/MONO, R	Connectors	1/4" phone jacks (TS unbalanced)	
		Output Impedance	1.1 [kΩ] stereo; 550 [Ω] mono (L/Mono only)	
		Maximum Level	+10.0 [dBu]	
		Load Impedance	10 [kΩ] or greater	
	Controllable by the VOLUME knob			
	Headphone output	Connectors	1/8" stereo mini-phone jack	
		Output Impedance	33 [Ω]	
Maximum Level		40 + 40 [mW]		
Controllable by the VOLUME knob				
Audio Inputs (Analog)	LINE IN	Connectors	1/8" stereo mini-phone jack	
		Input impedance	1.1 [kΩ]	
		Maximum input level	-42 to 0 [dBu]	
	MIC IN	Connectors	1/4" phone jacks (TS unbalanced)	
		Input impedance	33 [Ω]	
		Maximum input level	-48 to -6 [dBu]	
MIDI	IN, OUT			
USB	1 USB (TYPE B)	USB-MIDI interface, USB Audio interface		
SD-Card slot	Capacity recognized: SD memory cards up to 2 Gigabytes (GB). SDHC memory cards up to 32 Gigabytes (GB). SDXC memory cards are not supported.			

Power	AC adapter power supply jack (DC 9V,  ) , Power On/Off button AA alkaline batteries × 6, or nickel-metal hydride batteries × 6	
Battery life	AA alkaline batteries × 6	Approximately 6 hours
	AA nickel-metal hydride batteries (1900 mAh) × 6	Approximately 7 hours
	* Battery life will vary depending on the batteries used and on the conditions of use. * This is the time with the default factory settings.	
Power Consumption	5 W	
Dimensions (W × D × H)	KROSS2-61	935 × 269 × 88 mm / 36.81" × 10.59" × 3.46"
	KROSS2-88	1,448 × 383 × 136 mm / 57.01" × 15.08" × 5.35"
Weight	KROSS2-61	3.8 kg/8.38 lbs (excluding batteries)
	KROSS2-88	12.3 kg/27.12 lbs (excluding batteries)
Accessories	AC adapter, KROSS Quick Start Guide	

Options	XVP-10	Expression/Volume Pedal
	XVP-20	VOL/EXP PEDAL
	EXP-2	Foot Controller
	DS-1H	Damper Pedal
	PS-1, PS-3	Pedal Switch

## Operating requirements

### KORG USB-MIDI Driver

#### Windows

Operating system: Windows 7 SP1 (32-bit/64-bit)  
 Windows 8.1 update (32-bit/64-bit)  
 Windows 10 Anniversary Update (Version 1607)  
 Computer: USB port required (a USB host controller made by Intel is recommended)

#### Mac

Operating system: Mac OS X 10.10 or later, macOS 10.12, 10.13  
 Computer: Apple Macintosh computer with an Intel processor that has a USB port and satisfies the requirements for running Mac OS.

\* Appearance and specifications are subject to change without notice.

**Model: KROSS**

**MIDI Implementation Chart**

Ver.: 1.00

Function		Transmitted	Recognized	Remarks
Basic Channel	Default	1 – 16	1 – 16	Memorized
	Changed	1 – 16	1 – 16	
Mode	Memorized Messages Altered	× *****	3 ×	
Note Number:	True Voice	0 – 127 *****	0 – 127 0 – 127	All note numbers 0-127 can be transmitted by the Arpeggiator or as sequence data
Velocity	Note On Note Off	○ 9n, V=1 – 127 × 8n, V=64	○ 9n, V=1 – 127 ×	
Aftertouch	Polyphonic (Key) Monophonic (Channel)	○ ○	○ ○	Polyphonic aftertouch and Channel aftertouch transmitted only as sequence data *A (receive) *A (receive)
Pitch Bend		○	○	*C
Control Change	0, 32	○	○	Bank Select (MSB, LSB) *P
	1	○	○	Modulation wheel *C
	2, 4, 5	○	○	Controller, Pedal, Portamento Time *C
	7, 8, 10, 11	○	○	Volume, IFX pan, Pan, Expression *C
	12, 13, 16	○	○	Effect Control 1, 2, Controller *C
	64, 65, 66, 67	○	○	Damper, Portamento Sw., Sostenuto, Soft *C
	70-79	○	○	Sound controller *C
	80, 81, 82, 83	○	○	Switch 1, 2, Foot Switch, Controller *C
	93, 91, 92, 94	○	○	Send 1, 2, Effect ON/OFF (IFXs, MFXs, TFX) *C
	14, 22-24	○	○	Arpeggiator Controllers *C, *2
	6, 38, 96, 97	×	○	Data Entry (MSB, LSB), Increment, Decrement *C
	100, 101	×	○	RPN (LSB, MSB) *C, *3
0-119	○	○	Seq. Data *C (Seq when received)	
120, 121	×	○	All Sound Off, Reset All Controllers *C	
Program Change	Variable Range	○ 0 – 127 *****	○ 0 – 127 0 – 127	*P
System Exclusive		○	○	*E, *4
System Common	Song Position	○	○	*1
	Song Select Tune	○ 0 – 127 ×	○ 0 – 127 ×	
System Real Time	Clock	○	○	*1
	Command	○	○	*1
Aux Messages	Local On/Off	×	○	Transmitted only if MIDI Clock is Ext-MIDI or Ext-USB
	All Notes Off	×	○ 123 – 127	
	Active Sense	○	○	
	Reset	×	×	

Notes \*P, \*A, \*C, \*E: Transmitted/received when Global G-MIDI FILTER page (Program Change, Aftertouch, Control Change, Exclusive) is Enable, respectively.  
 \*1: When Global G-MIDI BASIC page MIDI Clock is Internal, transmitted but not received. The opposite for Ext-MIDI, Ext-USB.  
 \*2: Valid if the Global G-MIDI OUT page setting ARP Controllers MIDI Out is set to Control Change. The number shown here is the default setting.  
 \*3: RPN (LSB,MSB)=00,00: Pitch bend range, 01,00: Fine tune, 02,00: Coarse tune  
 \*4: In addition to Korg exclusive messages, Inquiry, GM System On, Master Volume, Master Balance, Master Fine Tune, and Master Coarse Tune are supported.

Mode 1: OMNI ON, POLY      Mode 2: OMNI ON, MONO      ○ : Yes  
 Mode 3: OMNI OFF, POLY      Mode 4: OMNI OFF, MONO      × : No

Consult your local Korg distributor for more information on MIDI IMPLEMENTATION.

# **KORG INC.**

4015-2 Yanokuchi, Inagi-City, Tokyo 206-0812 JAPAN

©2017 KORG INC.

[www.korg.com](http://www.korg.com)

Published 02/2018