

KAWAI

KDP90 Owner's Manual

Preparation Before Use

Playing the Piano

Internal Songs

Recorder

Settings

Appendix

Thank you for purchasing this Kawai digital piano.

This owner's manual contains important information regarding the usage and operation of the KDP90 digital piano.
Please read all sections carefully, keeping this manual handy for future reference.

Preface

■ About this Owner's Manual

Before attempting to play this instrument, please read the **Preparation Before Use** section from page 10 of this owner's manual. This section explains the name and function of each part, how to connect the power cable, and how to turn on the power.

The **Playing the Piano** section (page 12) provides an overview of the instrument's most commonly used functions, allowing the KDP90 digital piano to be enjoyed almost immediately after being connected, while the **Internal Songs** section (page 17) includes information regarding the built-in demonstration songs, Concert Magic songs, and Lesson function.

The **Recorder** section (page 26) provides instructions on how to record and play back pieces stored in the instrument's internal memory, and the **Settings** section (page 28) details the settings that can be used to adjust a number of sound and keyboard characteristics, as well as basic MIDI functionality.

Finally, the **Appendix** section (page 41) includes listings for all demo, Concert Magic, and Lesson function songs, a troubleshooting guide, assembly instructions, MIDI reference information, and full specification details.

■ KDP90 Feature Highlights

Advanced Hammer Action IV-F weighted-key keyboard action

The *Advanced Hammer Action IV-F* (AHA IV-F) keyboard action has been developed to represent the distinctive touch of an acoustic grand piano, with its remarkable springless design providing consistent upward and downward motion for a smooth, natural, piano playing experience.

Moreover, just as acoustic pianos utilise heavier bass hammers and lighter treble hammers, the AHA IV-F keyboard action also employs different hammer weights, appropriately graded for each playing range. Such attention to detail allows greater stability during fortissimo passages, while preserving delicate pianissimo control, to satisfy the demands of even the most discerning pianist.

Harmonic Imaging™ (HI) sound technology, 88-key piano sampling

The KDP90 digital piano captures the beautiful sound of Kawai's highly acclaimed hand-built concert grand piano, with all 88 keys of this exceptional instrument meticulously recorded, analysed and faithfully reproduced using proprietary *Harmonic Imaging™* technology. This unique process accurately recreates the broad dynamic range of the original grand piano, affording pianists an extraordinary level of expressiveness ranging from the softest pianissimo to the strongest, boldest fortissimo.

Additional reverberation effects that simulate the acoustic environment of a recital room, stage, or concert hall are also applied, resulting in a rich, vibrant piano tone that delivers breathtaking realism and authenticity.

Internal Song recorder, Built-in Lesson Function

The KDP90 digital piano features a three song recorder, allowing performances to be recorded to internal memory and played back at the touch of a button.

In addition, the convenient lesson feature allows aspiring pianists to learn the piano using a built-in collection of etudes from Czerny and Burgmüller, or songs from the popular *Alfred* course books. The left and right hand parts for each piece can be practiced separately, while adjusting the tempo allows more difficult passages to be perfected.

Important Safety Instructions

SAVE THESE INSTRUCTIONS

INSTRUCTIONS PERTAINING TO A RISK OF FIRE, ELECTRIC SHOCK, OR INJURY TO PERSONS



WARNING

TO REDUCE THE RISK OF FIRE OR ELECTRIC SHOCK, DO NOT EXPOSE THIS PRODUCT TO RAIN OR MOISTURE.

AVIS : RISQUE DE CHOC ELECTRIQUE - NE PAS OUVRIR.

TO REDUCE THE RISK OF ELECTRIC SHOCK, DO NOT REMOVE COVER (OR BACK). NO USER-SERVICEABLE PARTS INSIDE. REFER SERVICING TO QUALIFIED SERVICE PERSONNEL.



The lightning flash with arrowhead symbol, within an equilateral triangle, is intended to alert the user to the presence of uninsulated "dangerous voltage" within the product's enclosure that may be of sufficient magnitude to constitute a risk of electric shock to persons.



The exclamation point within an equilateral triangle is intended to alert the user to the presence of important operating and maintenance (servicing) instructions in the literature accompanying the product.

Examples of Picture Symbols



denotes that care should be taken.
The example instructs the user to take care not to allow fingers to be trapped.



denotes a prohibited operation.
The example instructs that disassembly of the product is prohibited.



denotes an operation that should be carried out.
The example instructs the user to remove the power cord plug from the AC outlet.

Read all the instructions before using the product.

- 1) Read these instructions.
- 2) Keep these instructions.
- 3) Heed all warnings.
- 4) Follow all instructions.
- 5) Do not use this apparatus near water.
- 6) Clean only with dry cloth.
- 7) Do not block any ventilation openings. Install in accordance with the manufacturer's instructions.
- 8) Do not install near any heat sources such as radiators, heat registers, stoves, or other apparatus (including amplifiers) that produce heat.
- 9) Do not defeat the safety purpose of the polarized or grounding-type plug. A polarized plug has two blades with one wider than the other. A grounding type plug has two blades and a third grounding prong. The wide blade or the third prongs are provided for your safety. If the provided plug does not fit into your outlet, consult an electrician for replacement of the obsolete outlet.
- 10) Protect the power cord from being walked on or pinched particularly at plugs, convenience receptacles, and the point where they exit from the apparatus.
- 11) Only use attachments/accessories specified by the manufacturer.
- 12) Use only with the cart, stand, tripod, bracket, or table specified by the manufacturer, or sold with the apparatus. When a cart is used, use caution when moving the cart/apparatus combination to avoid injury from tip-over. 
- 13) Unplug this apparatus during lightning storms or when unused for long periods of time.
- 14) Refer all servicing to qualified service personnel. Servicing is required when the apparatus has been damaged in any way, such as power-supply cord or plug is damaged, liquid has been spilled or object have fallen into the apparatus, the apparatus has been exposed to rain or moisture, does not operate normally, or has been dropped.

WARNING - When using electric products, basic precautions should always be followed, including the following.



WARNING

Indicates a potential hazard that could result in death or serious injury if the product is handled incorrectly.

The product should be connected to an AC outlet of the specified voltage.



- If you are going to use an AC power cord, make sure that its has the correct plug shape and conforms to the specified power voltage.
- Failure to do so may result in fire.

Do not insert or disconnect the power cord plug with wet hands.



Doing so may cause electric shock.

Take care not to allow any foreign matter to enter the product.

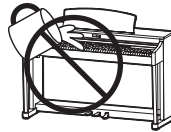

Entry of water, needles or hair pins may result in breakdown or short-circuit. The product shall not be exposed to dripping or splashing. No objects filled with liquids, such as vases, shall be placed on the product.

The chair must be used properly (it must be used only when playing the product).

- Do not play with it or stand on it.
- Only one person is allowed to sit on it.
- Do not sit on it when opening the lid.
- Re-tighten the bolts occasionally.

Doing so may cause the chair to fall over or your fingers to be trapped, resulting in injury.

When using the headphones, do not listen for long periods of time at high volume levels.



Doing so may result in hearing problems.

Do not lean against the keyboard.

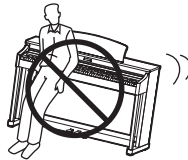

Doing so may cause the product to fall over, resulting in injury.

Do not disassemble, repair or modify the product.

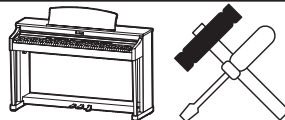

Doing so may result in product breakdown, electric shock or short-circuit.

When disconnecting the AC power cord's plug, always hold the plug and pull it to remove it.



- Pulling the AC power cord itself may damage the cord, causing a fire, electric shock or short-circuit.

The product is not completely disconnected from the power supply even when the power switch is turned off. If the product will not be used for a long time, unplug the AC power cord from the AC outlet.



- Failure to do so may cause fire in case of lightning.
- Failure to do so may over-heat the product, resulting in fire.

This product may be equipped with a polarized line plug (one blade wider than the other). This is a safety feature. If you are unable to insert the plug into the outlet, contact an electrician to replace your obsolete outlet. Do not defeat the safety purpose of the plug.

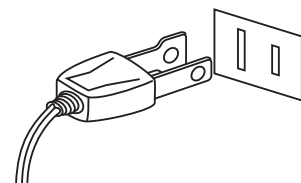

It is a good practice to have the instrument near the AC outlet and the power cord plug in a position so that it can readily be disconnected in an emergency because electricity is always charging while the plug is in the AC outlet even in a power switch off condition.



CAUTION

Indicates a potential hazard that could result in injury or damage to the product or other property if the product is handled incorrectly.

Do not use the product in the following areas.

- Areas, such as those near windows, where the product is exposed to direct sunlight
- Extremely hot areas, such as near a heater
- Extremely cold areas, such as outside
- Extremely humid areas
- Areas where a large amount of sand or dust is present
- Areas where the product is exposed to excessive vibrations

Using the product in such areas may result in product breakdown. Use the product only in moderate climates (not in tropical climates).

Use only the AC adaptor included with this instrument to power the instrument.

- Do not use other AC adaptors to power this instrument.
- Do not use the included AC adaptor or AC power cord to power other equipment.

When you close the keyboard cover, close it gently.

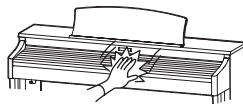

Closing it roughly may trap your fingers, resulting in injury.

Before connecting cords, make sure that the power to this product and other devices is turned OFF.



Failure to do so may cause breakdown of this product and other devices.

Do not drag the product on the floor. Take care not to drop the product.

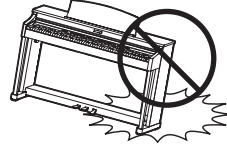

Please lift up the product when moving it. Please note that the product is heavy and must be carried by more than two persons. Dropping the product may result in breakdown.

Do not place the product near electrical appliances such as TVs and radios.

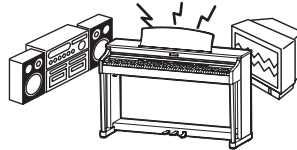

- Doing so may cause the product to generate noise.
- If the product generates noise, move the product sufficiently away from the electrical appliance or connect it to another AC outlet.

When connecting the AC power cord and other cords, take care not to get them tangled.



Failure to do so may damage them, resulting in fire, electric shock or short-circuit.

Do not wipe the product with benzene or thinner.



- Doing so may result in discoloration or deformation of the product.
- When cleaning the product, put a soft cloth in lukewarm water, squeeze it well, then wipe the product.

Do not stand on the product or exert excessive force.



- Doing so may cause the product to become deformed or fall over, resulting in breakdown or injury.

Do not place naked flame, such as lighted candles on the product.

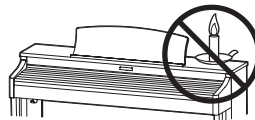

Doing so may cause the illumination to fall over, resulting in fire.

Ensure that the ventilation is not impeded by covering the ventilation openings with items, such as newspaper, table-cloths, curtains, etc.

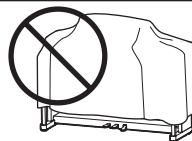

Failure to do so may over-heat the product, resulting in fire.

The product should be located so that its location or position does not interfere with its proper ventilation. Ensure a minimum distance of 5cm around the product for sufficient ventilation.

The product should be serviced by qualified service personnel when:

- The power supply cord or the plug has been damaged.
- Objects have fallen, or liquid has been spilled into the product.
- The product has been exposed to rain.
- The product does not appear to operate normally or exhibits a marked change in performance.
- The product has been dropped, or the enclosure damaged.

Notes on Repair

Should an abnormality occur in the product, immediately turn the power OFF, disconnect the power cord plug, and then contact the shop from which the product was purchased.

CAUTION:

To prevent electric shock, match wide blade of plug to wide slot, fully insert.

ATTENTION:

Pour éviter les chocs électriques, introduire la lame la plus large de la fiche dans la borne correspondante de la prise et pousser jusqu'au fond.



An information on Disposal for users

If your product is marked with this recycling symbol it means that, at the end of its life, you must dispose of it separately by taking it to an appropriate collection point. You should not mix it with general household waste. Disposing of this product correctly will prevent potential negative effects on the environment and human health which could otherwise arise due to inappropriate waste handling. For further details, please contact your local authority. (European Union only)

Instruction for AC power cord (U.K.)

IMPORTANT

THE WIRES IN THIS MAINS LEAD ARE COLOURED IN ACCORDANCE WITH THE FOLLOWING CODE.

- BLUE : NEUTRAL
- BROWN : LIVE

As the colours of the wires in the mains lead of this apparatus may not correspond with the coloured markings identifying the terminals in your plug, proceed as follows:
The wire which is coloured BLUE must be connected to the terminal which is marked with the letter N or coloured BLACK.
The wire which is coloured BROWN must be connected to the terminal which is marked with the letter L or coloured RED.
Do not plug either terminal of the power cord to the the ground od AC outlet on the wall.

Canadian Radio Interference Regulations

This instrument complies with the limits for a class B digital apparatus, pursuant to the Radio Interference Regulations, C.R.C., c. 1374.

FCC Information (U.S.A)

CAUTION : Changes or modifications not expressly approved by the party responsible for compliance could void the user's authority to operate the equipment.

NOTE : This equipment has been tested and found to comply with the limits for a Class B digital device, pursuant to Part 15 of the FCC Rules. These limits are designed to provide reasonable protection against harmful interference in a residential installation. This equipment generates, uses and can radiate radio frequency energy and, if not installed and used in accordance with the instructions, may cause harmful interference to radio communications. However, there is no guarantee that interference will not occur in a particular installation. If this equipment does cause harmful interference to radio or television reception, which can be determined by turning the equipment off and on, the user is encouraged to try to correct the interference by one or more of the following measures:

- Reorient or relocate the receiving antenna.
- Increase the separation between the equipment and receiver.
- Connect the equipment into an outlet on a circuit different from that to which the receiver is connected.
- Consult the dealer or an experienced radio/TV technician for help.

The nameplate label is located on the underside of the instrument, as indicated below.

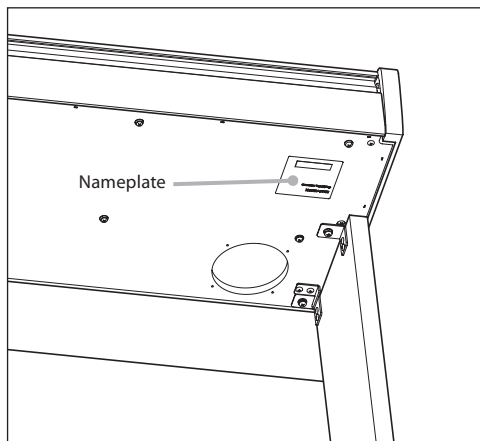

Table of Contents

Preface	3
Important Safety Instructions	4
Table of Contents	9

Preparation Before Use

Part Names and Functions	10
Setting Up the Piano	11

Playing the Piano

Selecting Sounds	12
Using the Pedals	13
Dual Mode	14
Four Hands Mode	15
Metronome	16

Internal Songs

Demo Songs	17
Concert Magic	18
Concert Magic demo modes	19
Concert Magic Mode	20
Concert Magic song arrangement types	21
Concert Magic song list	22
Lesson Function	23
1 Selecting a lesson book/song	23
2 Listening to the selected lesson song	24
3 Practicing left and right-hand parts separately	25

Recorder

Recorder	26
1 Recording a song	26
2 Playing back a song	27
3 Erasing recorded songs	27

Settings

Keyboard and Sound Settings	28
1 Damper Resonance	29
2 Reverb	30
3 Touch	31
4 Tuning	32
5 Transpose	33
MIDI Settings	34
1 Transmit MIDI Program Change	36
2 MIDI Channel (transmit/receive)	37
3 Local Control	38
4 Multi-timbral Mode	39
Power Settings	40
1 Auto Power Off	40

Appendix

Connecting to Other Devices	41
Troubleshooting	42
Assembly Instructions	43
Demo Song List	47
Concert Magic Song List	47
Lesson Function Song Lists	48
Specifications	50
MIDI Implementation Chart	51
Operation Guide	53

Part Names and Functions

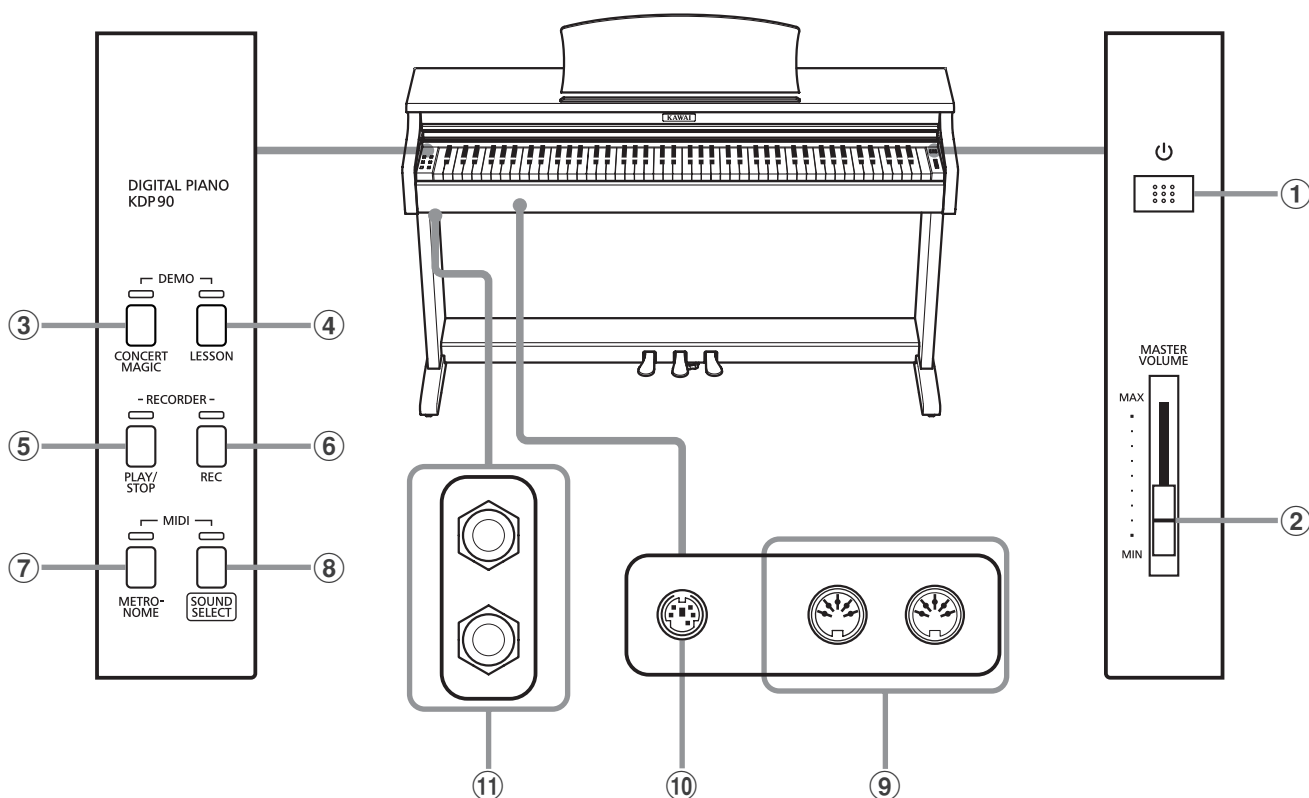

① POWER switch

This switch is used to turn the KDP90 digital piano on/off. Be sure to turn off the instrument after playing.

② MASTER VOLUME slider

This slider controls the master volume level of the KDP90 digital piano's built-in speakers or headphones, if connected.

③ CONCERT MAGIC button

This button is used to start/stop playback of the KDP90 digital piano's built-in Concert Magic songs.

④ LESSON button

This button is used to select the KDP90 digital piano's built-in Lesson songs.

⑤ PLAY / STOP button

This button is used to start/stop the playback of Recorder songs stored in memory and KDP90 digital piano's built-in Lessons songs.

⑥ REC button

This button is used to record performances to the KDP90 digital piano's internal memory.

⑦ METRONOME button

This button is used to turn the metronome function on/off, and also to adjust its tempo, time signature, and volume settings.

⑧ SOUND SELECT button

This button is used to select the sound(s) that will be heard when the keys are pressed.

⑨ MIDI IN / OUT jacks

These jacks are used to connect the KDP90 digital piano to external MIDI devices, such as other musical instruments or a computer, in order to send and receive MIDI data.

⑩ PEDAL connector

This connector is used to connect the KDP90 digital piano's pedal board to the instrument.

⑪ PHONES jacks

These jacks are used to connect stereo headphones to the KDP90 digital piano. Two pairs of headphones can be connected and used simultaneously.

■ Operation Guide

The separate Operation Guide provides a convenient overview of the KDP90 digital piano's various button and keyboard controls. This sheet is also reprinted in the Appendix section of this owner's manual.

Setting Up the Piano

1. Connecting the power adaptor

Connect the AC power adaptor to the DC IN terminal located on the underside of the instrument, as indicated below.

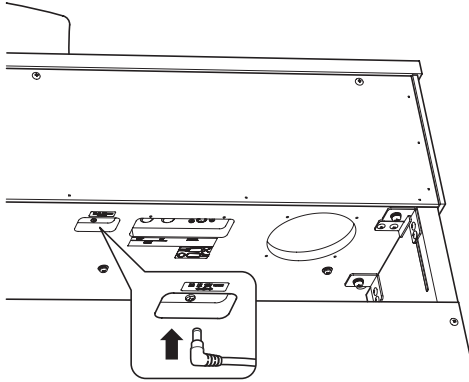

3. Turning on the power

Press the POWER switch, located on the right hand side of the instrument's front panel.

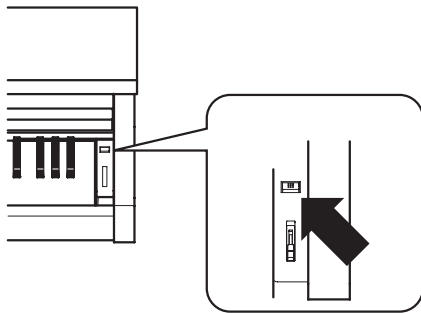

The LED indicator for the SOUND SELECT button will turn on and the Concert Grand sound will be selected automatically.

■ Using headphones

Use the jacks located beneath the keyboard on the left hand side, to connect stereo headphones to the KDP90 digital piano.

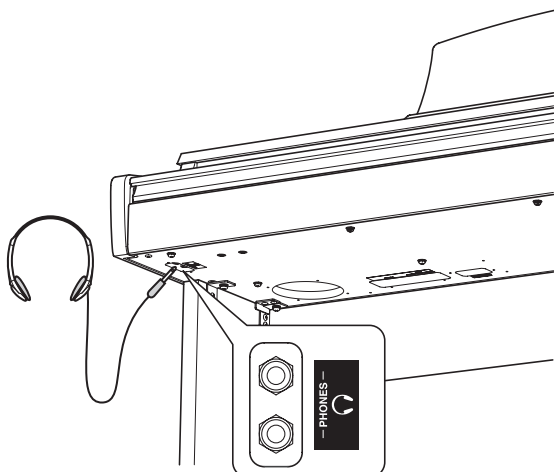

Up to two pairs of headphones can be connected and used simultaneously. When a pair of headphones is connected, sound will not be produced by the speakers.

2. Connecting the power adaptor to an outlet

Connect the AC power adaptor to an AC outlet.

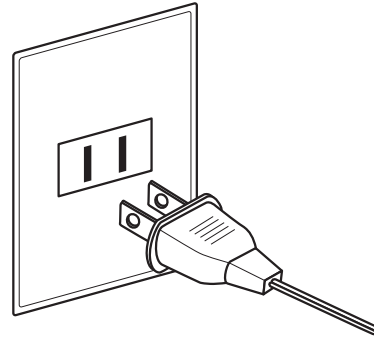

4. Adjusting the volume

Move the MASTER VOLUME slider up and down to increase and decrease the volume level of the instrument's speakers, or headphones if connected.

Adjust the volume to a comfortable listening level - the middle is often a good starting point.

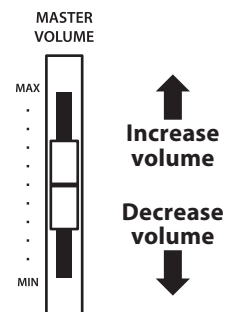

■ Adjusting the pedal support bolt

A pedal support bolt is attached at the base of the pedal board to aid stability when the pedals are pushed. Turn the bolt anti-clockwise until it makes contact with the floor and supports the pedals firmly.

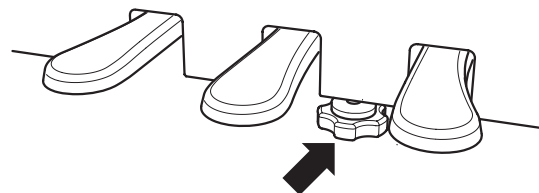

When moving the instrument, always adjust or remove the pedal support bolt, then readjust when the instrument is in its new position.

Selecting Sounds

The KDP90 digital piano features 15 different instrument sounds, which can be selected in one of two ways. By default the 'Concert Grand' sound will be selected automatically when the instrument is turned on.

Instrument Sounds

Sound name	Description
Concert Grand	A concert grand piano with a rich, expansive tone.
Concert Grand 2	A concert grand piano with a refined, clear tone.
Studio Grand	A grand piano with a brightly voiced tone.
Modern Piano	A modern grand piano with clean, distinctive tone.
Classic E.Piano	A vintage electric piano.
Modern E.Piano	A modern electric piano.
Jazz Organ	A vintage tonewheel organ.
Church Organ	A traditional pipe organ.
Harpichord	A baroque period plucked instrument.
Vibraphone	A percussive, tuned instrument played using mallets.
String Ensemble	A string ensemble.
Slow Strings	A string ensemble with a slow, gradual attack.
Choir	An ensemble of singing voices.
New Age Pad	A synthesised science fiction sound.
Atmosphere	A synthesised atmospheric sound.

Selecting a sound: Method 1

Press the SOUND SELECT button repeatedly to cycle through the 15 available instrument sounds.

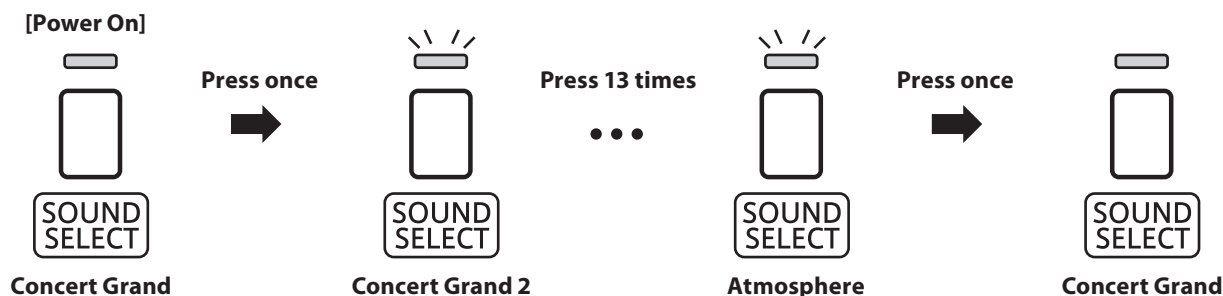

* When the Concert Grand sound is selected the LED indicator for the SOUND SELECT button will turn on.

* When a sound other than Concert Grand is selected the LED indicator for the SOUND SELECT button will start to flash.

Selecting a sound: Method 2

Press and hold the SOUND SELECT button, then press one of the lowest 15 white keys to selected the desired instrument sound.

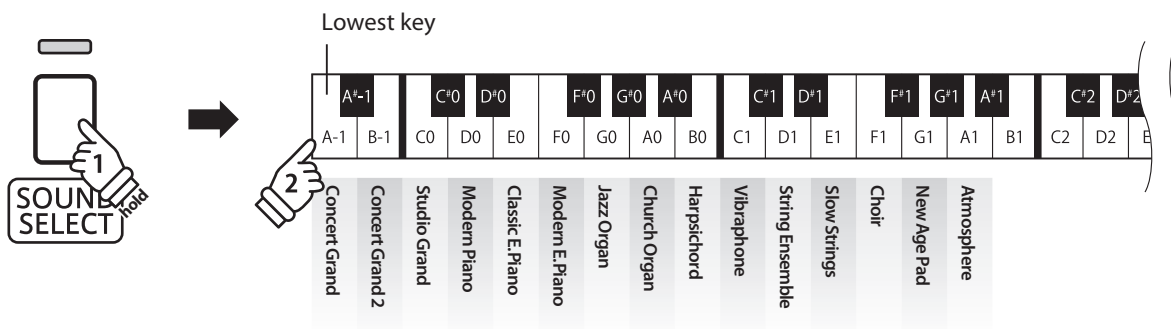

Using the Pedals

As with a grand piano, the KDP90 digital piano features three pedals: sustain, sostenuto, and soft.

■ Sustain pedal (right pedal)

Depressing this pedal sustains the sound after one's hands have been lifted from the keyboard - greatly enriching the piano sound, while also assisting smooth 'legato' passages.

The sustain pedal is capable of responding to half pedaling.

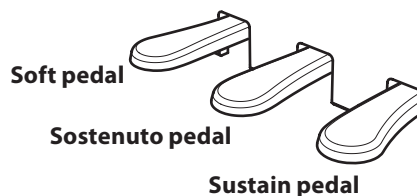

■ Soft pedal (left pedal)

Depressing this pedal softens the sound, reducing its volume.

When the Jazz Organ sound is selected, the soft pedal is also used to alternate the speed of the rotary speaker simulation between 'Slow' and 'Fast' effect modes.

■ Sostenuto pedal (centre pedal)

Depressing this pedal after playing the keyboard and before releasing the keys, sustains the sound of only those notes that have been played. Any keys that are subsequently played after the sostenuto pedal is depressed will not be sustained.

■ Pedal support bolt

If the pedal support bolt does not make contact with the floor, the pedal board may become damaged. Ensure that this bolt is fully extended and supports the pedals firmly.



When moving the instrument, always adjust or remove the pedal support bolt, then readjust when the instrument is in its new position.

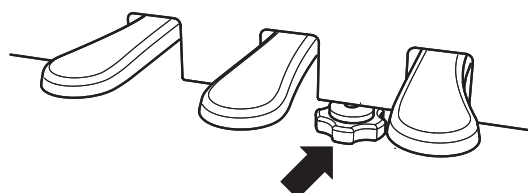

■ Caring for the pedals

If the surface of the pedals becomes dirty, clean the pedals using a dry dish-washing sponge. Do not attempt to clean the pedals using rust-removing solvents, abrasives or files.

■ Grand Feel pedal system

The KDP90 digital piano features the new Grand Feel pedal system, which replicates the sustain, soft, and sostenuto pedal weighting of Kawai's EX Concert Grand piano.

Dual Mode

The Dual Mode function allows two sounds to be layered together, creating a more complex sound. For example, a piano sound layered with strings, or an electric piano combined with a harpsichord etc.

■ Enabling Dual Mode

Press and hold the SOUND SELECT button, then press two of the lowest 15 white keys simultaneously.

The sounds corresponding to the two keys will be layered together.

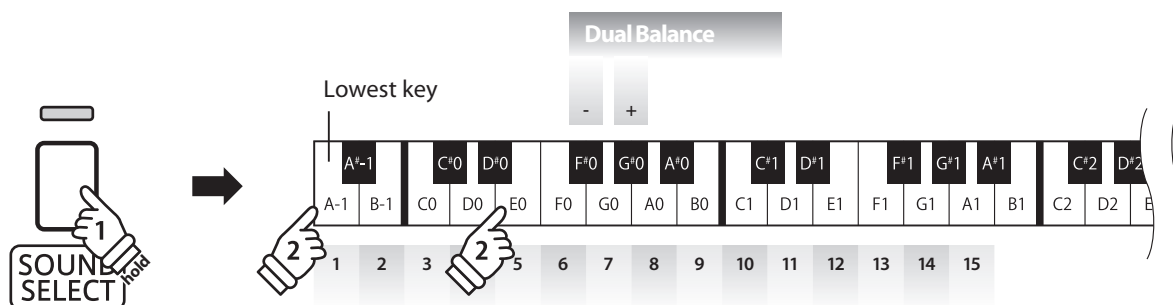

■ Adjusting the volume balance

Press and hold the SOUND SELECT button, then press the F#0 or G#0 keys repeatedly to decrease or increase the volume balance between the two sounds.

■ Exiting Dual Mode

Press the SOUND SELECT button.

The Concert Grand sound will be selected automatically and the instrument will return to normal operation.

Four Hands Mode

The Four Hands Mode function divides the keyboard into two sections, with the sustain (right) and soft (left) pedal acting as independent sustain pedals for each section. The octave/pitch of each section is also adjusted, allowing two people to perform piano duets within the same key range using a single instrument.

■ Enabling Four Hands Mode

Press and hold the LESSON button, then press the D#2 key, as shown in the illustration below.

The LED indicators for the LESSON button will start to flash, indicating that Four Hands Mode is enabled.

* The selected keyboard sound can still be changed when Four Hands Mode is enabled.

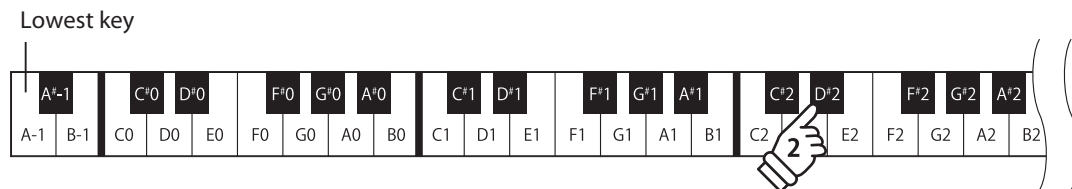

■ Exiting Four Hands Mode

Press the LESSON button.

The instrument will return to normal operation.

* With the Four Hands Mode activated, selecting a different sound will affect both the left and right sections.

* It is not possible to use the Recorder function with the Four Hands Mode activated.

* The Split Point for the Four Hands Mode is set to F3, and cannot be adjusted.

* The sostenuto pedal will affect the right section sound only.

Metronome

The Metronome function provides a steady beat to aid practicing the piano at a consistent tempo. The time signature, volume, and tempo of the metronome can be freely adjusted.

Turning the metronome on/off

Press the METRONOME button.

The metronome will start to count and the LED indicator for the METRONOME button will turn on, indicating that the metronome is in use.

* By default the metronome will count with a 1/4 beat at 120 bpm.

Press the METRONOME button again to stop the metronome.



Changing the metronome time signature

Press and hold the METRONOME button, then press one of the 7 lowest black keys, as shown in the illustration below.

* The metronome can be set to one of seven time signatures:

* 1/4, 2/4, 3/4, 4/4, 5/4, 3/8, and 6/8.

Adjusting the metronome volume

Press and hold the METRONOME button, then press the keys marked -/+ in the illustration below.

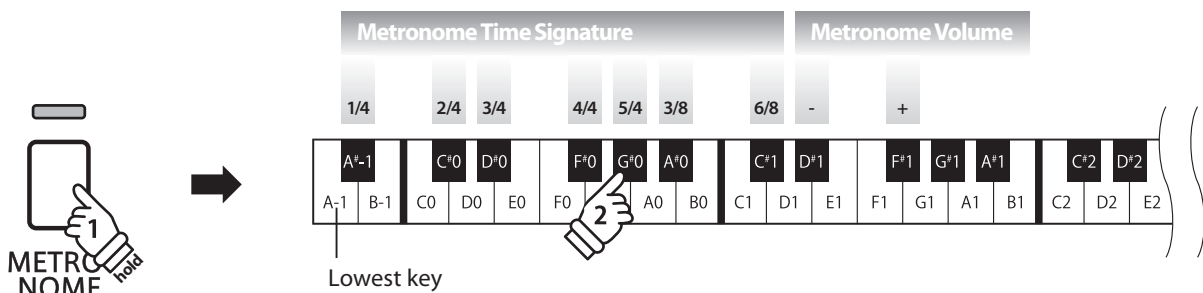

Adjusting the metronome tempo

Press and hold the METRONOME button, enter the desired tempo using the lowest 12 white keys marked below, then release the METRONOME button.

* The metronome tempo can be adjusted within the range of 10-300 bpm.

* The metronome tempo can be entered precisely, or decreased and increased gradually.

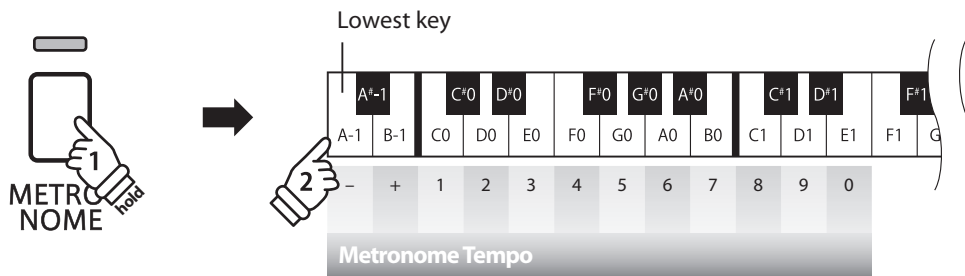

Method 1:

While pressing the METRONOME button, press keys 1, 5, and 0 to set the tempo to 150 bpm, or keys 8 and 5 to set the tempo to 85 bpm.

Method 2:

While pressing the METRONOME button, press the - / + keys repeatedly to gradually decrease or increase the tempo in 2 bpm increments.

Demo Songs

The KDP90 digital piano includes a selection of demonstration songs to introduce each internal sound.

■ Demo songs

Sound name	Song name	Composer
Concert Grand	Hungarian Rhapsodies No.6	Liszt
Concert Grand 2	Petit Chien	Chopin
Studio Grand	Original	Kawai
Modern Piano	Original	
Classic E.Piano	Original	
Modern E.Piano	Original	
Jazz Organ	Original	
Church Organ	Chorale Prelude "Wachet auf, ruft uns die Stimme."	Bach
Harpsichord	French Suite No.6	Kawai
Vibraphone	Original	
String Ensemble	Le quattro stagioni: la "Primavera"	Vivaldi
Slow Strings	Original	Kawai
Choir	Londonderry Air	Irish folk song
New Age Pad	Original	Kawai
Atmosphere	Original	

* Kawai regret that sheet music for Kawai original demo songs is not available.

1. Playing the demo songs

Press the CONCERT MAGIC and LESSON buttons simultaneously.

The LED indicators for the CONCERT MAGIC and LESSON buttons will start to flash, and the demo song for the Concert Grand sound will start to play.

* When the Concert Grand demo song has finished, another demo song will be selected at random. This process will continue until all of the demo songs have been played.

Press either the CONCERT MAGIC or LESSON buttons to stop the demo.

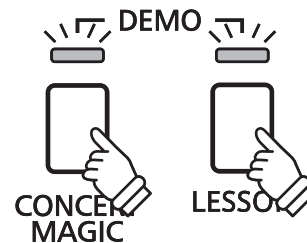

2. Selecting a demo song

While the demo is playing:

To listen to the demo song for a particular sound, press and hold the SOUND SELECT button, then press one of the lowest 15 white keys assigned to the desired sound.

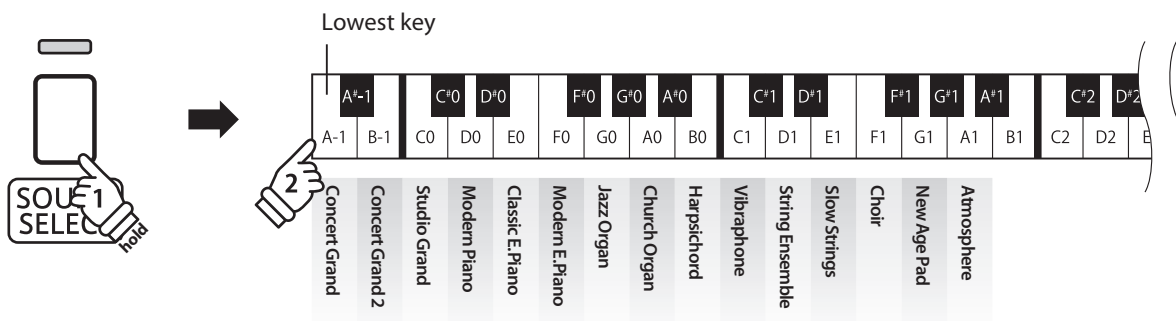

Alternatively, press the SOUND SELECT button to skip to the next demo song.

Concert Magic

The Concert Magic function allows complete beginners to enjoy playing the piano by simply selecting one of the 40 pre-programmed songs, then tapping the keyboard with a steady rhythm and tempo.

The Concert Magic songs are categorised by group and assigned to the lowest 40 white keys of the keyboard. For a complete listing of available Concert Magic songs, please refer to page 22 of this owner's manual.

■ Selecting a Concert Magic song

Press and hold the CONCERT MAGIC button, then press the white key assigned to the desired Concert Magic song.

The LED indicator for the CONCERT MAGIC button will turn on, indicating that Concert Magic playing mode is in use.

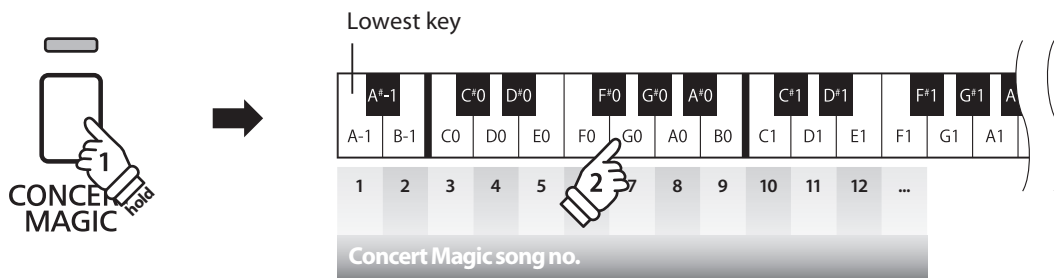

■ Listening to the selected Concert Magic song

Press the PLAY/STOP button.

The LED indicator for the PLAY/STOP button will turn on and the selected Concert Magic song will start to play.

- * The selected song will play repeatedly until it is stopped.
- * To listen to a different Concert Magic song simply repeat the above step.



Press either the PLAY/STOP or CONCERT MAGIC buttons again to stop the song.

■ Performing the selected Concert Magic song

Press keys on the keyboard.

The song will advance with every key that is pressed.

Pressing the keys gently will produce a soft sound, while pressing heavily will produce a loud sound. Similarly, pressing the keys quickly will increase the tempo of the song, while pressing slowly will decrease the tempo.

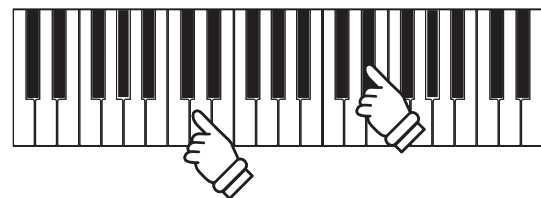

■ Exiting Concert Magic playing mode

Press the CONCERT MAGIC button.

The LED indicator for the CONCERT MAGIC button will turn off and the instrument will return to normal operation.



Concert Magic demo modes

The Concert Magic demo modes allow the Concert Magic songs to be listened to in one of three ways: All Play, Category Play, and Random Play

■ All Play

Press the CONCERT MAGIC button, then press the PLAY/STOP button.

The LED indicator for the PLAY/STOP button will turn on and the Concert Magic songs will start to play in numerical order.

Press either the CONCERT MAGIC or PLAY/STOP buttons again to stop song playback.

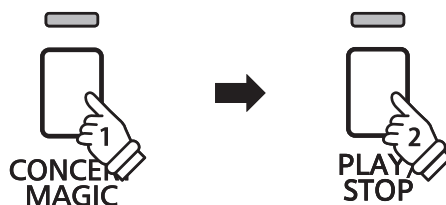

■ Category Play

Press and hold the CONCERT MAGIC button, then press the white key assigned to the desired Concert Magic song. While still holding the CONCERT MAGIC button, press the LESSON button.

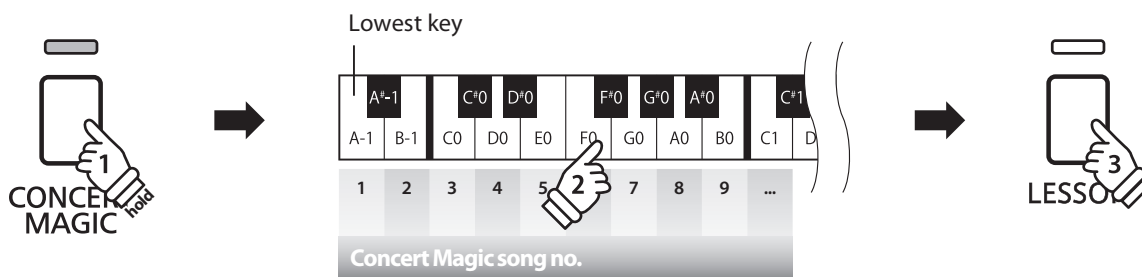

The selected Concert Magic song will start to play.

* When the selected song finishes, the next song in the same category will start to play automatically.

■ Random Play

Press the CONCERT MAGIC button and then press the LESSON button.

The KDP90 digital piano will play back the first Concert Magic song, followed by the remaining 39 Concert Magic songs in random order.

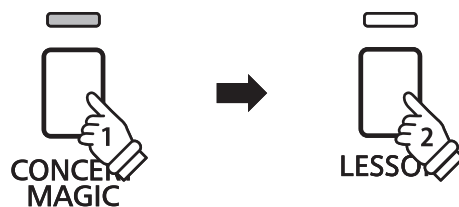

Concert Magic Mode

The Concert Magic Mode setting changes the Concert Magic playing mode, allowing all Concert Magic songs to be played by simply tapping any key with a constant steady beat, regardless of the song arrangement type.

Concert Magic Mode

Concert Magic Mode	Description	Key
Normal	Concert Magic songs will be performed according to their arrangement type.	C#0
Steady Beat	All Concert Magic songs will be performed by tapping the key with a constant beat.	D#0

Changing the Concert Magic Mode

Press and hold the CONCERT MAGIC button, then press the key assigned to the desired Concert Magic Mode.

The selected Concert Magic Mode type will be applied immediately.

* When the instrument is turned on, the Concert Magic Mode setting will return to the default type of 'Normal'.

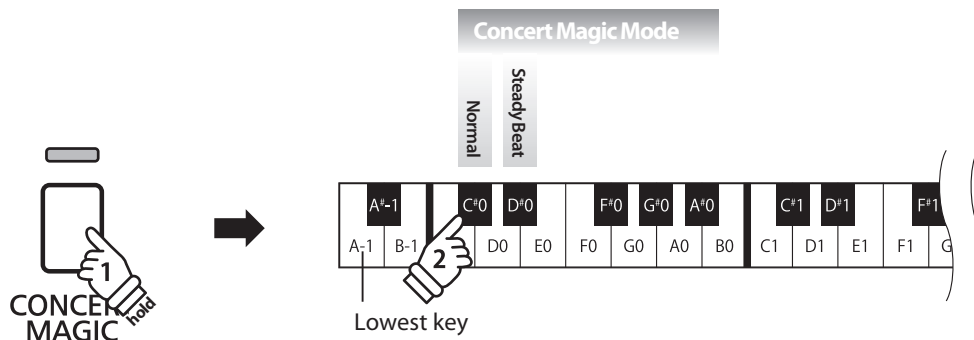

Concert Magic song arrangement types

Concert Magic songs are divided into three different arrangement types: Easy Beat (EB), Melody Play (MP), and Skillful (SK). Each arrangement type requires a different level of skill to be performed correctly.

Easy Beat

EB

These are the easiest songs to play. To perform them, simply tap out a constant, steady beat on any key of the keyboard. For example, when playing the piece 'Für Elise', a constant, steady rhythm should be maintained throughout the song.

Key on: X

Melody Play

MP

These songs are also relatively easy to play, especially if they are familiar to the player. To perform them, tap out the rhythm of the melody on any key of the keyboard. Singing along as the rhythm is tapped can be helpful. For example, when playing the piece 'Twinkle, Twinkle, Little Star', the rhythm of the melody should be played.

* When performing fast Concert Magic songs, it may be easier to press different keys with two alternating fingers in order to achieve greater speed.

Key on: X X X X X X X X X X X X X X X

Skillful

SK

These songs range in difficulty from moderately difficult to difficult. To perform them, tap out the rhythm of both the melody and the accompaniment notes on any key of the keyboard.

For example, when playing the piece 'Waltz of the Flowers', the rhythm of both the melody and the accompaniment should be played.

Key on: X X X X X X X X X X X X X

Concert Magic song list

No.	Song Name	Type
Children's Songs		
1	Twinkle, Twinkle, Little Star	MP
2	I'm A Little Teapot	MP
3	Mary Had A Little Lamb	MP
4	London Bridge	MP
5	Row, Row, Row Your Boat	MP
6	Frère Jacques	MP
7	Old MacDonald Had A Farm	MP

Christmas Songs		
8	Hark The Herald Angels Sing	MP
9	Jingle Bells	MP
10	Deck The Halls	MP
11	O Come All Ye Faithful	MP
12	Joy To The World	MP
13	Silent Night	MP
14	We Wish You A Merry Christmas	MP

American Classics		
15	Battle Hymn Of The Republic	MP
16	Yankee Doodle	MP
17	Danny Boy	EB
18	Clementine	MP
19	Auld Lang Syne	MP
20	Oh Susanna	SK
21	The Camptown Races	MP
22	When The Saints Go Marching In	EB
23	The Entertainer	SK

No.	Song Name	Type
Classical Selections		
24	William Tell Overture	SK
25	Andante from Symphony No.94 (Haydn)	MP
26	Für Elise	EB
27	Clair De Lune	SK
28	Skater's Waltz	SK
29	Blue Danube Waltz	SK
30	Gavotte (Gossec)	SK
31	Waltz Of The Flowers	SK

Special Occasions		
32	Bridal Chorus	MP
33	Wedding March	SK
34	Pomp And Circumstance	SK

International Songs		
35	When Irish Eyes Are Smiling	EB
36	Chiapanecas	SK
37	Santa Lucia	SK
38	Funiculi Funiculà	SK
39	Romance De L'amour	EB
40	My Wild Irish Rose	EB

Lesson Function

The Lesson function allows budding pianists to practice the piano using a selection of built-in song books. The left and right hand parts for each piece can be practiced separately, while adjusting the tempo allows difficult passages to be perfected.

For a complete listing of available Lesson Function songs, please refer to page 48 of this owner's manual.

Built-in lesson function song books

	US, Canada, Australasia	Rest of the World
Book 1	Alfred's Basic Piano Library Lesson Book Level 1A	Burgmüller 25 (25 Etudes Faciles, Opus 100)
Book 2	Alfred's Basic Piano Library Lesson Book Level 1B	Czerny 30 (Etudes de Mécanisme, Opus 849)

* Lesson books sold separately - please refer to page 49 of this owner's manual for more information.

1 Selecting a lesson book/song

Entering lesson mode

Press the LESSON button.

The LED indicator for the LESSON button will turn on, indicating that lesson mode is enabled, and the Concert Grand sound will be selected automatically.



Selecting a lesson song from Book 1

While lesson mode is selected:

Press and hold the LESSON button, then press the white key assigned to the desired lesson song.

Book 1:
Song no. 5



Lowest key

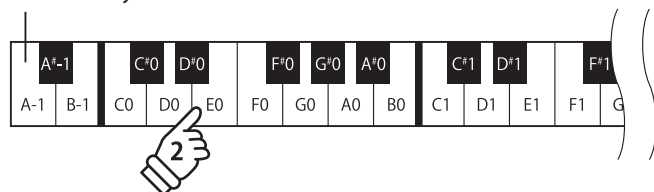

Book 2:
Song no. 10



Lowest key

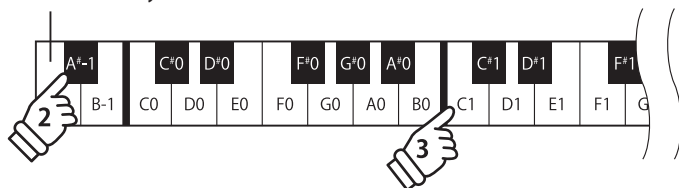

2 Listening to the selected lesson song

This page will explain how to play and stop the selected lesson song, and adjust the tempo.

■ Playing the lesson song

After selecting a lesson book and song:

Press the PLAY/STOP button.

The LED indicator for the PLAY/STOP button will turn on, and a one bar count-in will be heard before the song starts to play.

While the lesson song is playing, press the METRONOME button to turn the metronome on/off.

* The metronome time signature and tempo will automatically be set to that of the currently selected lesson song.



■ Adjusting tempo of the lesson song

While the lesson song is playing:

Press and hold the METRONOME button, enter the desired tempo using the lowest 12 white keys marked below, then release the METRONOME button.

* The lesson song tempo can be adjusted within the range of 10-300 bpm.
 * The lesson song tempo can be entered precisely, or decreased and increased gradually.

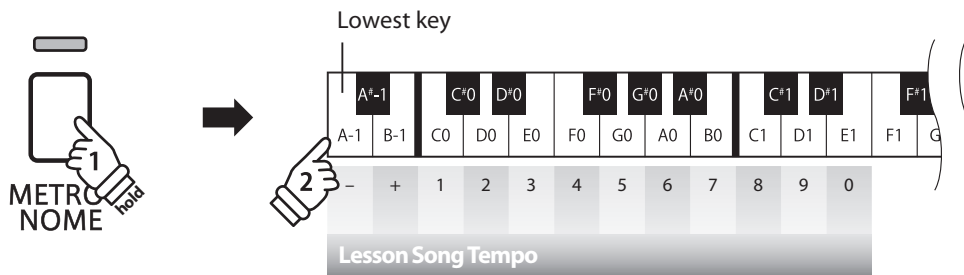

Method 1:

While pressing the METRONOME button, press keys 1, 5, and 0 to set the tempo to 150 bpm, or keys 8 and 5 to set the tempo to 85 bpm.

Method 2:

While pressing the METRONOME button, press the - / + keys repeatedly to gradually decrease or increase the tempo in 2 bpm increments.

■ Stopping the lesson song

While the lesson song is playing:

Press the PLAY/STOP button again to stop the lesson song.

The LED indicator for the PLAY/STOP button will turn off.



3 Practicing left and right-hand parts separately

This page will explain how to mute/activate the left and right-hand parts of the selected lesson song, allowing each part to be practiced separately.

The LED indicators for the METRONOME and SOUND SELECT buttons are used to indicate which part (left or right-hand) of the selected lesson song is muted/active.

METRONOME button LED	SOUND SELECT button LED	Lesson song playback
On	On	Left and Right-hand parts (default playing mode)
On	Off	Left-hand part only
Off	On	Right-hand part only

■ Muting/activating lesson song parts

After selecting a lesson book and song:

Press the SOUND SELECT button.

The LED indicator for the SOUND SELECT button will turn off (the LED indicator for the METRONOME button will remain turned on), indicating that only the left-hand part of the lesson song is active (i.e. the right-hand part will be muted).

Press the SOUND SELECT button again.

The LED indicator for the SOUND SELECT button will turn on and the LED indicator for the METRONOME button will turn off, indicating that only the right-hand part of the lesson song is active (i.e. the left-hand part will be muted).

Press the SOUND SELECT button once again.

The LED indicator for the SOUND SELECT button will remain turned on and the LED indicator for the METRONOME button will also turn on, indicating that both the left and right-hand parts of the lesson song are active.

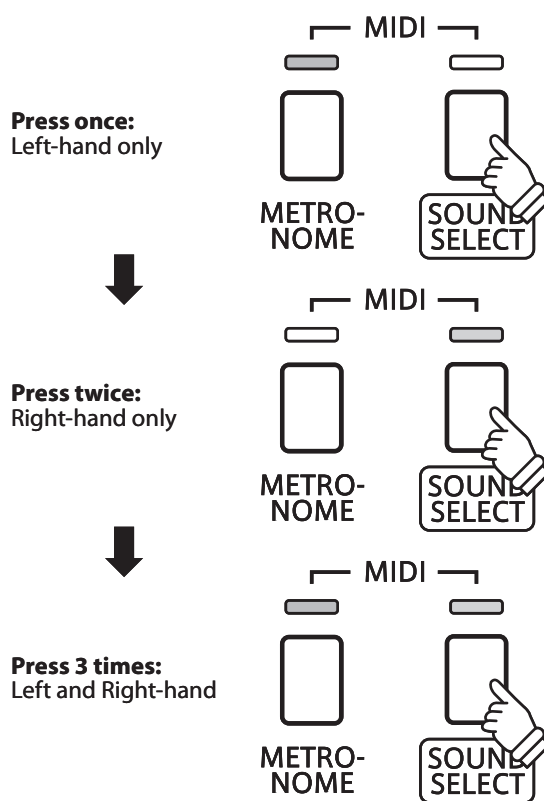

■ Exiting lesson mode

Press the LESSON button.

The LED indicator for the LESSON button will turn off, and the instrument will return to normal operation.



Recorder

The KDP90 digital piano allows up to 3 different songs to be recorded, stored in internal memory, and played back at the touch of a button.

1 Recording a song

1. Entering song recorder mode

Press the REC button.

The LED indicator for the REC button will start to flash, to indicate that the piano is in recording standby mode.



2. Selecting a song memory

Press and hold the REC button, then press one of the lowest three white keys to select the desired song memory.

* Selecting a song memory that has already been used to record a song will automatically erase the previously recorded song.

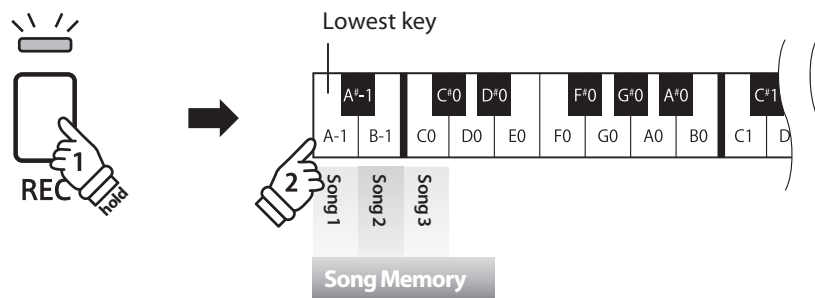

3. Starting the song recorder

Press a key on the keyboard.

The LED indicators for the REC and PLAY/STOP buttons will turn on, and recording will start.

* Recording can also be started by pressing the PLAY/STOP button, allowing a rest period or empty bar to be inserted at the beginning of the song.

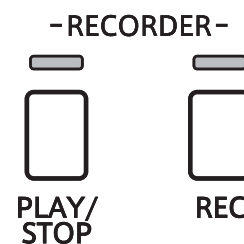

4. Stopping the song recorder

Press the PLAY/STOP button.

The LED indicators for the PLAY/STOP and REC buttons will flash briefly, and the song will be stored in internal memory.

* Do not turn the power off while the song is saving to memory.

* The maximum recording capacity is approximately 15,000 notes, with button and pedal presses also counted as one note. If the maximum recording capacity is reached during recording, the recorder will stop automatically.

* Recorder songs will remain in memory after the power is turned off.

2 Playing back a song

1. Playing the recorded song

Press the PLAY/STOP button.

The LED indicator for the PLAY/STOP button will turn on, and the recorded song will start to play.



2. Playing a song stored in another memory

Press and hold the PLAY/STOP button, then press one of the lowest three white keys to play the desired song memory.

* The selected song will start to play when the PLAY/STOP button is released.

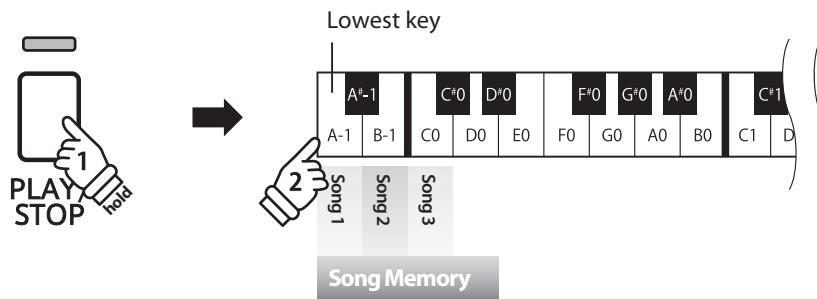

3 Erasing recorded songs



Warning: This process will erase all three songs stored in internal memory, and cannot be undone.

Erasing the recorder songs

Press and hold the PLAY/STOP and REC buttons simultaneously, then turn the instrument's power off/on.

All recorder songs stored in memory will be erased.

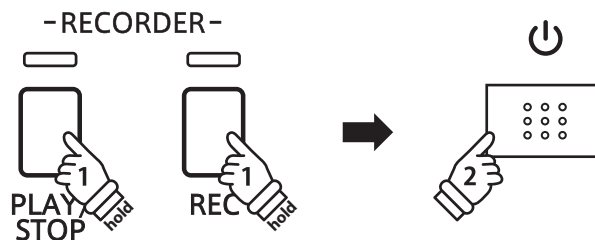

Keyboard and Sound Settings

The KDP90's keyboard and sound settings allow various aspects of the instrument to be adjusted.

■ Keyboard and Sound Settings

Setting name	Explanation	Default setting
Damper Resonance	Adjust the resonance that is heard when depressing the damper pedal.	Medium
Reverb	Change the type of reverberation added to the sound.	Small Hall
Touch	Change the touch sensitivity of the keyboard.	Normal
Tuning	Increase or decrease the pitch of the keyboard in 0.5 Hz steps.	440.0Hz
Transpose	Increase or decrease the pitch of the keyboard in semi-tone steps.	0

■ Changing settings

Press and hold the SOUND SELECT button, then press the key(s) assigned to the desired setting.

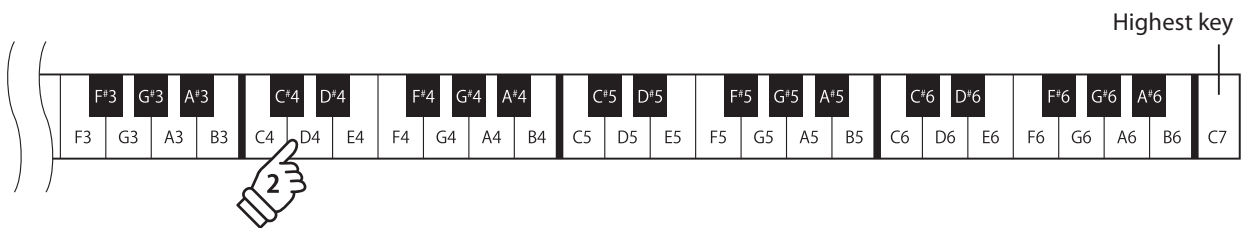

1 Damper Resonance

Depressing the sustain pedal of an acoustic piano raises all dampers, allowing the strings to vibrate freely. When a note or chord is played on the piano with the sustain pedal depressed, not only will the strings of the notes played vibrate, but also the strings of other notes, vibrating in sympathetic resonance.

The KDP90 digital piano recreates this phenomenon, with the Damper Resonance setting allowing the volume of this resonance to be changed.

■ Damper Resonance

Sounds affected by Damper Resonance

Concert Grand

Concert Grand 2

Studio Grand

Modern Piano

■ Damper Resonance type

Damper Resonance type	Description	Key
Off	Disables the damper resonance effect.	C#1
On	(Re)Enables the damper resonance effect.	D#1
Small	Piano sounds produce a small amount of damper resonance.	F#1
Medium	(default) Piano sounds produce a medium amount of damper resonance.	G#1
Large	Piano sounds produce a large amount of damper resonance.	A#1

■ Changing the Damper Resonance type

Press and hold the SOUND SELECT button, then press the key assigned to the desired Damper Resonance type.

* To disable/enable the damper resonance effect, press the key assigned to the off/on function.

* If the damper resonance effect is disabled, it will be turned on automatically upon selecting a damper resonance type.

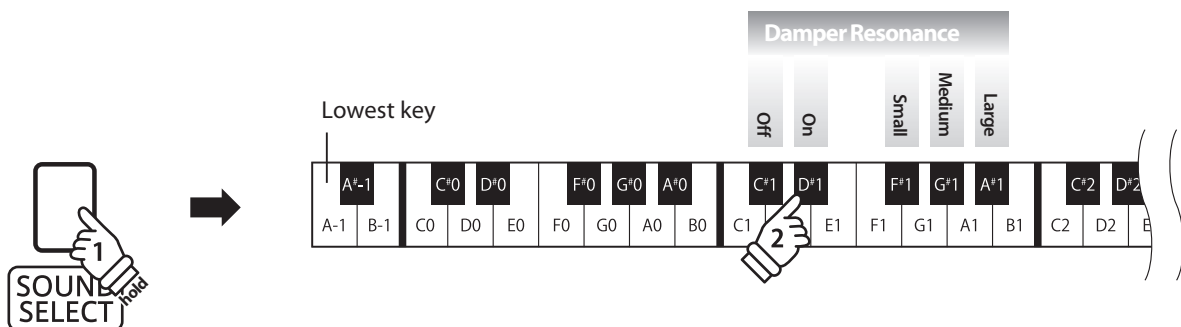

2 Reverb

The Reverb setting adds reverberation to the sound, simulating the acoustic environment of a recital room, stage, or concert hall. The most suitable reverb type is applied automatically when selecting each sound, however it is also possible to select a different reverb type manually if desired.

■ Reverb type

Reverb type	Description	Key
Off	Disables the reverb effect.	C#2
On	(Re)Enables the reverb effect.	D#2
Room	Simulates the ambiance of a small rehearsal room.	C2
Small Hall	Simulates the ambiance of a small hall.	D2
Concert Hall	Simulates the ambiance of a concert hall or theater.	E2

■ Changing the Reverb type

Press and hold the SOUND SELECT button, then press the key assigned to the desired Reverb type.

* To disable/enable the reverb effect, press the key assigned to the 'off/on' function.

* If the reverb effect is disabled, it will be turned on automatically upon selecting a reverb type.

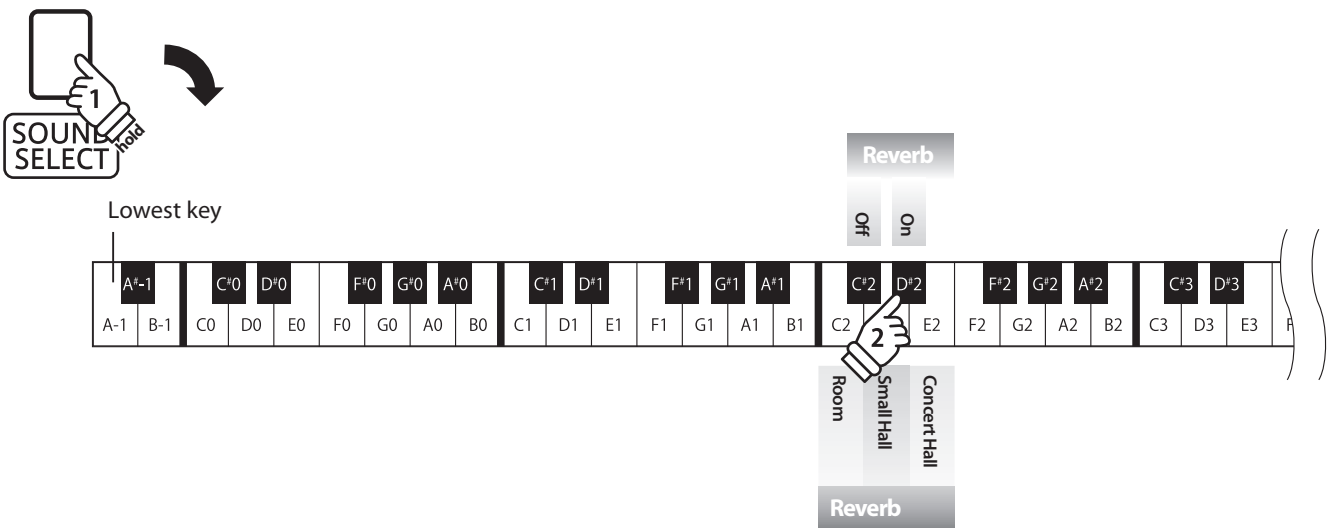

3 Touch

As with an acoustic piano, the KDP90 digital piano produces a louder sound when the keys are struck with force, and a softer sound when the keys are played gently. The volume and tonal character change in relation to the strength and speed of playing - on a digital piano this system is referred to as 'touch sensitivity'.

The Touch setting allows the touch sensitivity of the keyboard to be conveniently adjusted. There are four different preset touch settings available.

■ Touch type

Touch type	Description	Key
Off	A constant volume is produced regardless of how hard the keys are struck. This setting is recommended for sounds that have a fixed dynamic range such as organ and harpsichord.	C#3
Light	A louder volume is produced even when playing with a soft touch. This setting is recommended for children and organ players, or for those still developing finger strength.	F#3
Normal (default)	Reproduces the standard touch sensitivity of an acoustic piano.	G#3
Heavy	Requires a heavier touch to produce a loud volume. This setting is recommended to those with stronger fingers.	A#3

■ Changing the Touch type

Press and hold the SOUND SELECT button, then press the key assigned to the desired touch type.

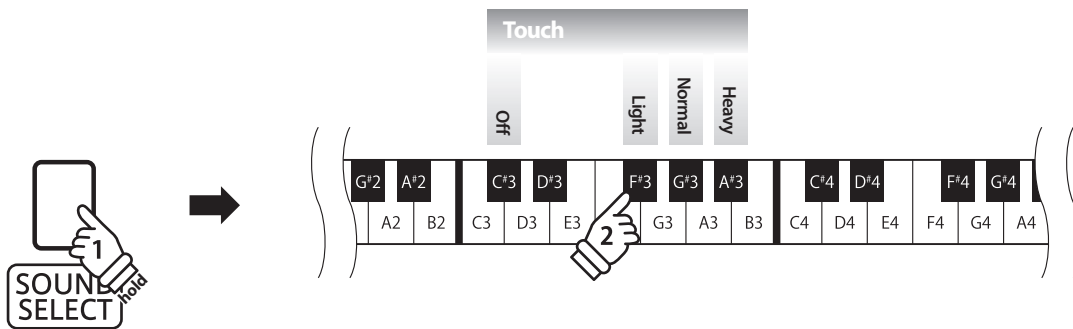

4 Tuning

The Tuning setting allows the overall pitch of the KDP90 digital piano to be raised and lowered in 0.5 Hz steps, and may therefore prove useful when playing with other instruments.

■ Adjusting the Tuning setting: Method 1

Press and hold the SOUND SELECT button, then enter the desired pitch using the number keys indicated below.

* The keyboard pitch can be adjusted within the range of 427 - 453 Hz.

* To reset the pitch to 440.0Hz, press the Reset key indicated below.

■ Adjusting the Tuning setting: Method 2

Press and hold the SOUND SELECT button, then press the keys assigned +/- to lower or raise the keyboard pitch in 0.5 Hz steps.

Example A=441.5 Hz
Enter 4, 4, 1, then press the + key.

Tuning
440.0Hz

Tuning
+0.5Hz
-0.5Hz

Tuning
1 2 3 4 5 6 7 8 9 0

Highest key

5 Transpose

The Key Transpose setting allows the pitch of the KDP90 digital piano keyboard to be raised or lowered in semi-tone steps. This is particularly useful when accompanying instruments with different tones, or when a song learned in one key must be played in another key. When transposed, the song can be played in the original key, yet heard in a different key.

■ Adjusting the Transpose setting

Press and hold the SOUND SELECT button, then press the keys assigned +/- to lower or raise the keyboard pitch in semi-tone steps.

* The transpose setting can be adjusted within the range of -6 - +5 semi-tones.

* To disable/enable the transpose setting, press the key assigned to the 'off/on' function.

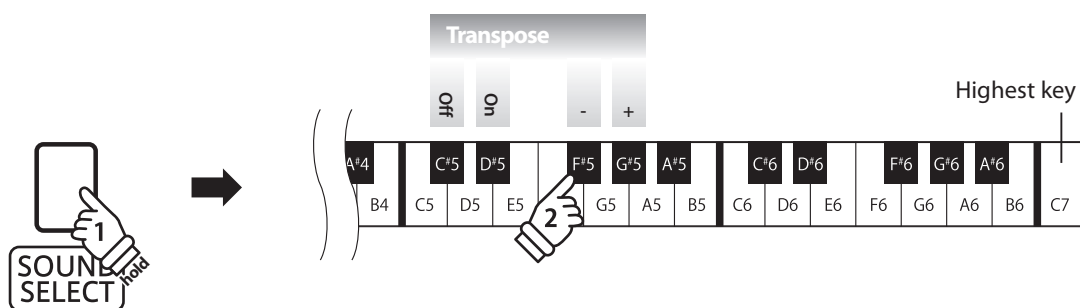

MIDI Settings

The term MIDI is an acronym for Musical Instrument Digital Interface, an international standard for connecting musical instruments, computers, and other devices to allow the exchange of performance data.

■ MIDI terminals

MIDI terminal	Function
MIDI IN	Receiving note, program change, and other data.
MIDI OUT	Sending note, program change, and other data.

■ MIDI channels

MIDI uses channels to exchange data back and forth between MIDI devices. There are receive (MIDI IN) and transmit (MIDI OUT) channels. Most musical instruments or devices with MIDI functions are equipped with both MIDI IN and OUT jacks and are capable of transmitting and receiving data via MIDI. The receive channels are used to receive data from another MIDI device and the transmit channels are used to transmit data to another MIDI device.

The illustration below shows three musical instruments, connected together using MIDI.

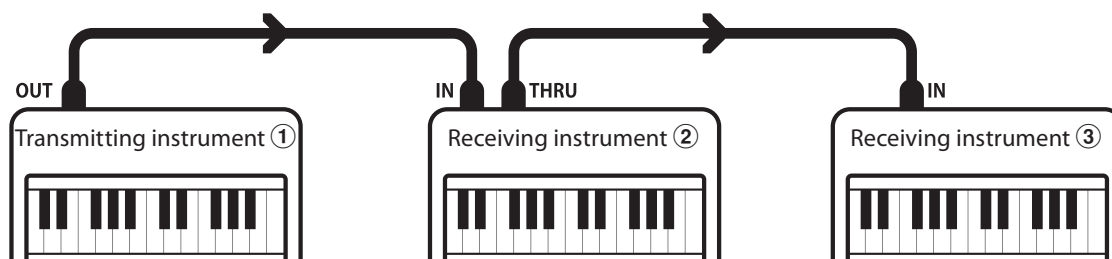

Transmitting instrument ① sends transmit channel and keyboard information to receiving instruments ②/③. The information arrives at the receiving instruments ②/③. Receiving instruments ②/③ will respond to MIDI data that is sent if their receive channel is the same as the transmit channel of the transmitting instrument ①. If the channels do not match, then the receiving instruments ②/③ will not respond to any data that is sent.

For both receiving and transmitting, channels 1-16 can be used.

■ Recording/playing with a sequencer

When connected to a sequencer, the KDP90 digital piano can be used to record and playback multi-track songs, with separate sounds playing simultaneously on each channel.

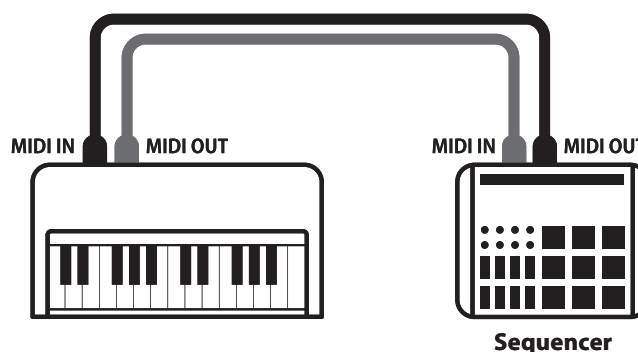

■ MIDI functions

The KDP90 digital piano supports the following MIDI functions:

Transmit/receive note information

Transmit/receive note information from a MIDI-connected musical instrument or device.

Transmit/receive channel settings

Specify transmit/receive channels within the range of 1 to 16.

Transmit/receive exclusive data

Transmit/receive front panel or menu function settings as exclusive data.

Multi-timbral mode setting

Receive multiple channel MIDI data from a MIDI-connected musical instrument or device.

* Multi-timbral mode setting must be enabled.

Transmit/receive Program Change number

Transmit/receive program change data to/from a MIDI-connected musical instrument or device.

Transmit/receive pedal data

Transmit/receive sustain, sostenuto, and soft pedal data from a MIDI-connected musical instrument or device.

Receive volume data

Receive MIDI volume data sent from a MIDI-connected musical instrument or device.

* Please refer to the 'MIDI Implementation Chart' on page 51 for further information regarding the MIDI capabilities of the KDP90 digital piano.

■ MIDI settings

Function name	Explanation	Default setting
Transmit Program Change Number	Specify whether or not program change information is sent when sounds are changed. Send a MIDI program change number from 1 to 128.	On
MIDI Channel	Specify the channel used to transmit/receive MIDI information.	1ch
Local Control	Specify whether or not internal sounds will be heard when the keyboard is pressed.	On
Multi-timbral mode	Specify whether or not MIDI information can be received on more than one channel.	Off

■ Changing MIDI settings

Press and hold the METRONOME and SOUND SELECT buttons, then press the key(s) assigned to the desired functions.

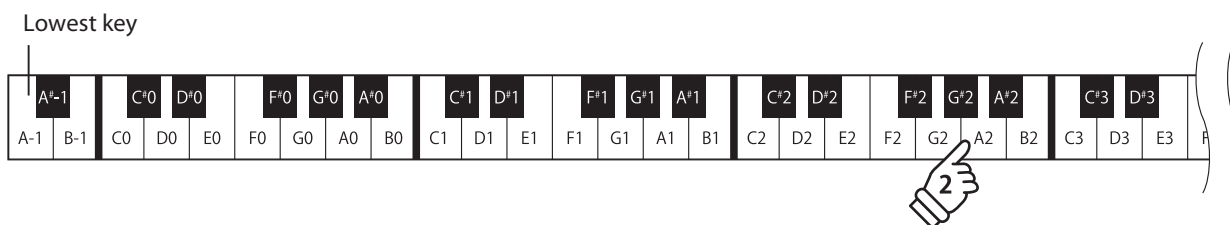
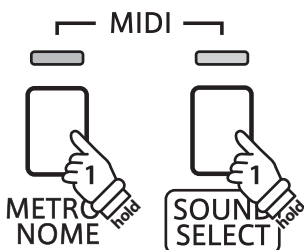

1 Transmit MIDI Program Change

The Send Program Change Number setting determines whether or not the KDP90 digital piano will transmit program change information when sounds are changes. It is also possible to transmit a program change number (ranging from 1 to 128) in order to change the sound of an external MIDI device.

■ Transmit MIDI Program Change settings

Transmit PGM#	Explanation	Key
Off	The instrument will NOT transmit program change numbers when changing sounds.	C#0
On (default)	The instrument will transmit program change numbers when changing sounds.	D#0

■ Changing the Transmit MIDI Program Change setting

Press and hold the METRONOME and SOUND SELECT buttons, then press the key assigned to the desired Transmit MIDI Program Change setting.

■ Sending a Program Change number

Press and hold the METRONOME and SOUND SELECT buttons, then enter the desired program change number to send using the number keys indicated below.

* Program change numbers are specified as three digits within the range of 001 - 128.

* The program change number will be transmitted automatically when the key for the third digit number is pressed.

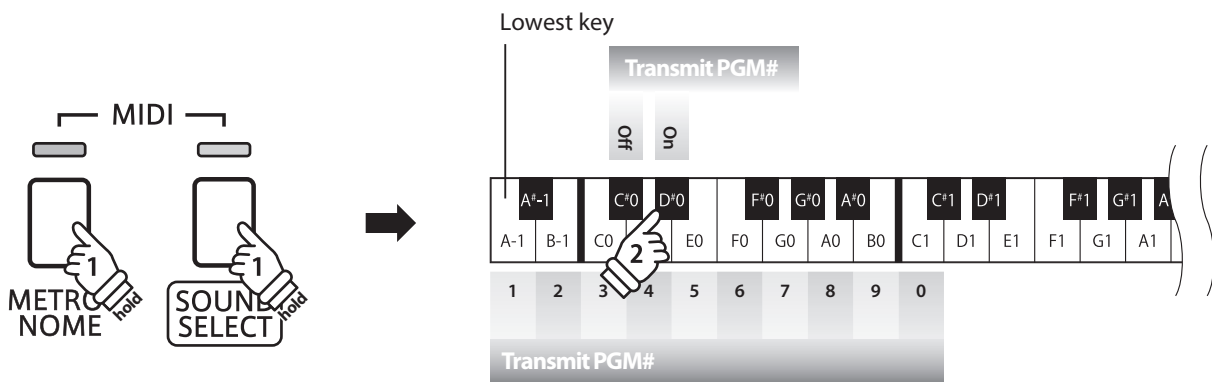

Example: Transmit PGM#064

Enter 0, 6, then 4

2 MIDI Channel (transmit/receive)

The MIDI Channel setting allows the transmit/receive channel to be specified. The selected channel will function as both the transmit and receive channel (separate transmit/receive channels cannot be specified).

■ Changing the MIDI Channel setting

Press and hold the METRONOME and SOUND SELECT buttons, then press the key assigned to the desired MIDI channel.

* The MIDI channel can be specified within the range of 1-16.

* The MIDI channel is automatically set to '1' when the instrument is turned on (default setting).

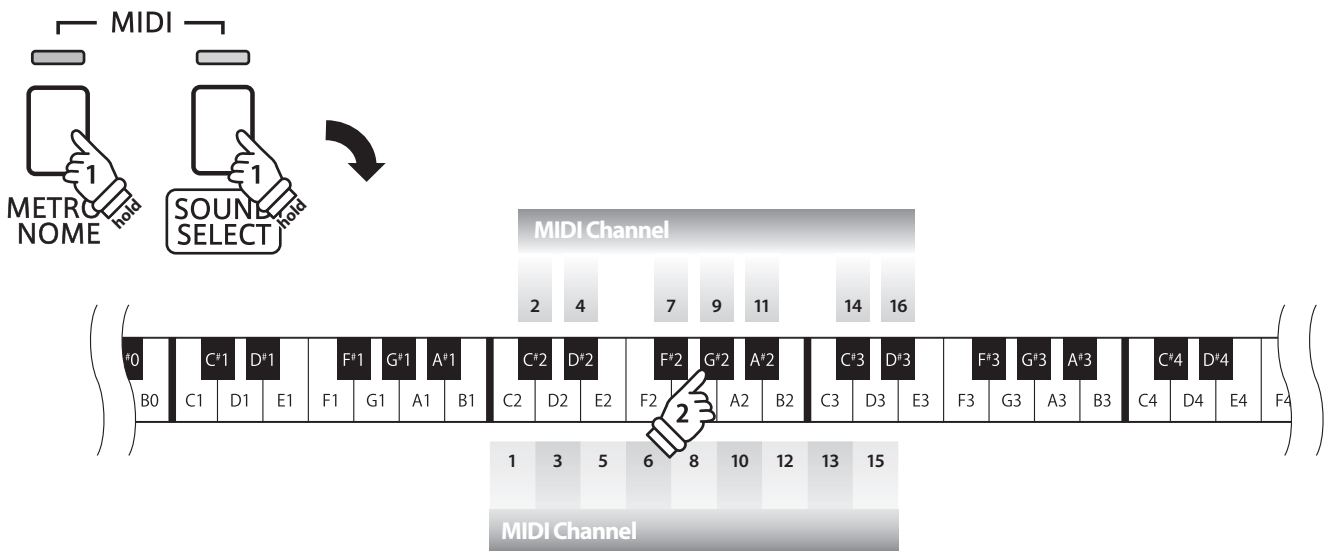

3 Local Control

The Local Control setting determines whether the instrument will play an internal sound when the keys are pressed. This setting is useful when using the KDP90 digital piano to control an external MIDI device.

Local Control settings

Local Control	Explanation	Key
Off	The instrument will transmit information to an external MIDI device only.	C#4
On (default)	The instrument will play an internal sound and transmit information to an external MIDI device.	D#4

Changing the Local Control setting

Press and hold the METRONOME and SOUND SELECT buttons, then press the key assigned to the desired Local Control setting.

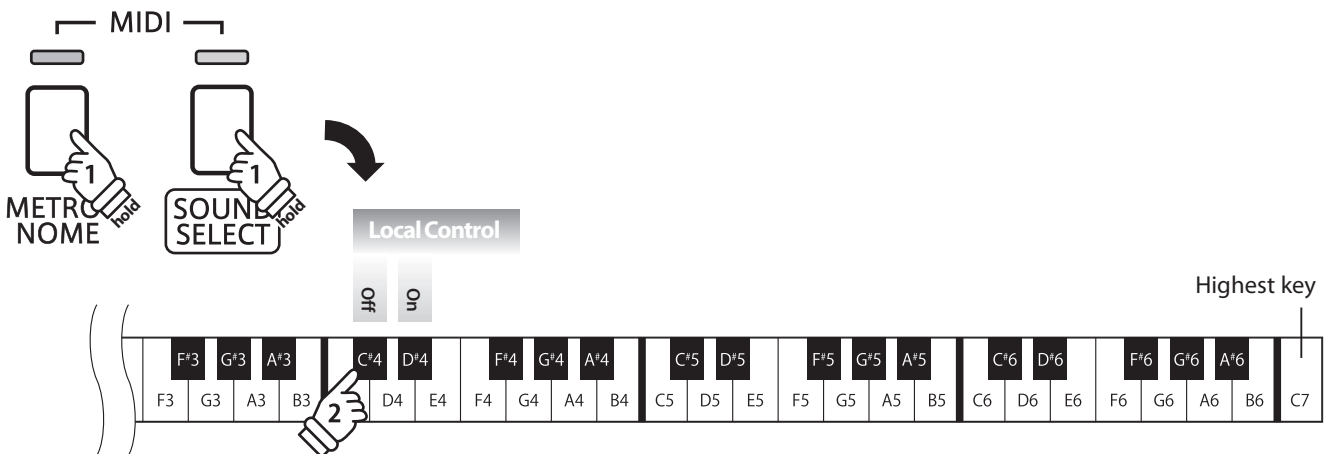

4 Multi-timbral Mode

The Multi-timbral mode setting determines whether or not the KDP90 digital piano is able to receive MIDI information on more than one MIDI channel simultaneously. This allows the instrument to play back multi-track, multi-timbral performance data sent from an external MIDI device.

Multi-timbre settings

Multi-timbre	Explanation	Key
Off (default)	Multi-timbral mode disabled	C#5
On	Multi-timbral mode enabled*	D#5

* Please refer to the 'Program Change Number List' below.

Changing the Multi-timbral mode setting

Press and hold the METRONOME and SOUND SELECT buttons, then press the key assigned to the desired Multi-timbre setting.

* MIDI data received through channel 10 will not be performed when Multi-timbre is enabled.

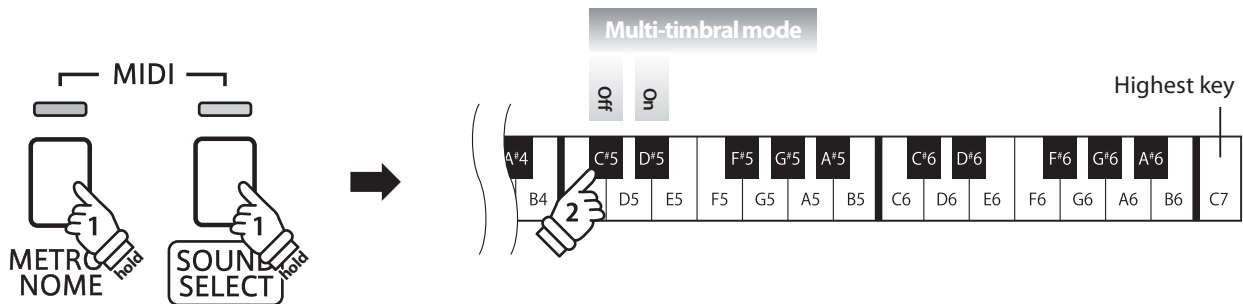

Program Change Number List

Sound name	Multi-timbral mode Off	Multi-timbral mode On		
	Program number	Program number	Bank MSB	Bank LSB
Concert Grand	1	1	121	0
Concert Grand 2	2	1	95	16
Studio Grand	3	1	121	1
Modern Piano	4	2	121	0
Classic E.Piano	5	5	121	0
Modern E.Piano	6	6	121	0
Jazz Organ	7	18	121	0
Church Organ	8	20	121	0
Harpichord	9	7	121	0
Vibraphone	10	12	121	0
String Ensemble	11	49	121	0
Slow Strings	12	45	95	1
Choir	13	53	121	0
New Age Pad	14	89	121	0
Atmosphere	15	100	121	0

Power Settings

1 Auto Power Off

The KDP90 digital piano features a power saving function that can be used to automatically turn off the instrument after a specified period of inactivity.

* This setting will be stored automatically, and recalled every time the instrument is turned on.

■ Auto Power Off settings

Auto Power Off	Explanation	Key
Off	The Auto Power Off function is disabled.	G6
30 min.	The instrument will turn off automatically after 30 minutes of inactivity.	A6
60 min.	The instrument will turn off automatically after 60 minutes of inactivity.	B6
120 min.	The instrument will turn off automatically after 120 minutes of inactivity.	C7

■ Selecting the Auto Power Off setting

Press and hold the METRONOME and SOUND SELECT buttons simultaneously, then press the key assigned to the desired Auto Power Off setting.

* The Auto Power Off setting will be stored automatically, and recalled every time the instrument is turned on.

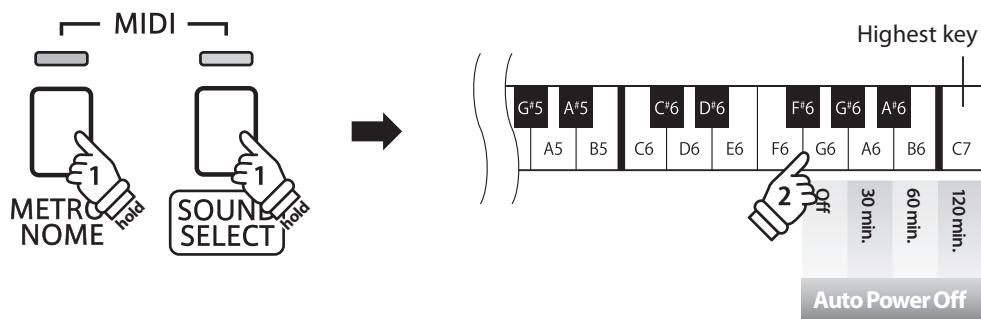

Connecting to Other Devices

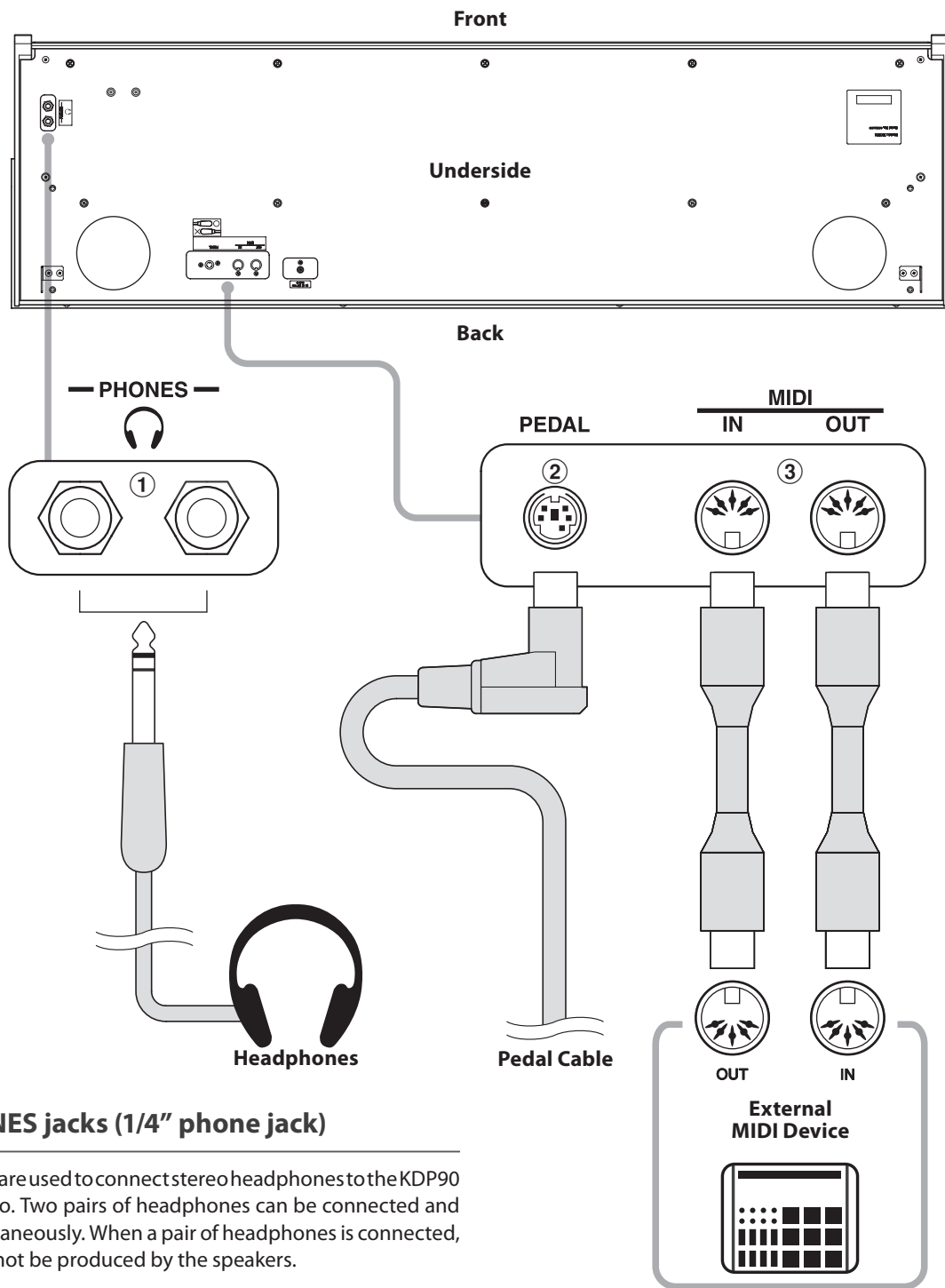

① PHONES jacks (1/4" phone jack)

These jacks are used to connect stereo headphones to the KDP90 digital piano. Two pairs of headphones can be connected and used simultaneously. When a pair of headphones is connected, sound will not be produced by the speakers.

② PEDAL connector

This connector is used to connect the pedal board to the KDP90 digital piano (see page 46).

③ MIDI IN/OUT jacks

These jacks are used to connect the KDP90 digital piano to external MIDI devices, such as a sound module, or a computer with a MIDI interface.

Troubleshooting

	Problem	Possible Cause and Solution	Page no.
Power	The instrument does not turn on.	Check that the power cable is firmly attached to the instrument, and connected to an AC outlet.	p. 11
	The instrument turns itself off after a period of inactivity.	Check that the 'Auto Power Off' function is not enabled.	p. 40
Sound	The instrument is turned on, however no sound is produced when the keys are played.	Check that the MASTER VOLUME slider is not set to the lowest position.	p. 11
		Check that a pair of headphones (or headphone adaptor plug) are not connected to the PHONES jack.	p. 11
		Check that Local Control is enabled in the MIDI Settings menu.	p. 38
	The sound distorts when playing at very loud volume levels.	Check that the MASTER VOLUME slider is set to an appropriate level, reducing the volume if excessive distortion is heard.	p. 11
	Strange sounds or noises are heard when playing with piano sounds.	<p>The KDP90 digital piano attempts to reproduce the rich variety of tones created by an acoustic grand piano as accurately as possible. This includes damper resonances and other subtle effects that contribute to the overall piano playing experience.</p> <p>While these additional effects are intended to enhance the realism of the instrument, it is possible to reduce their prominence, or disable them altogether using the sound settings.</p>	p.29 p.30
Pedals	The pedals are unreliable or do not function at all.	Check that the pedal cable is firmly connected to the instrument.	p. 46
	When depressing a pedal, the pedal board flexes and is not firm.	Check that the pedal support bolt is fully extended.	p. 46
	The top 18 notes of the keyboard sustain for longer than neighbouring notes, even when the damper pedal is not pressed.	This is the correct behaviour, and intended to reproduce the undamped notes (typically the top two octaves) of an acoustic grand piano.	—

Assembly Instructions



Please read these assembly instructions thoroughly before attempting to assemble the KDP90 digital piano.
Please ensure that two or more people work on assembling the KDP90 digital piano, especially when lifting the main body of the instrument onto the stand in step 3.

■ Included parts

Before attempting to assemble the KDP90 digital piano, ensure that all parts below are included.
A Phillips-head screwdriver (not included) will also be required in order to assemble the instrument.

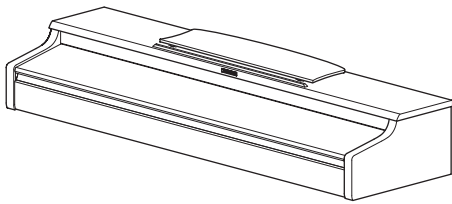

① Main body

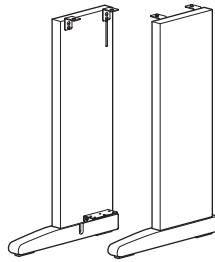

② Side panel
(left, right)

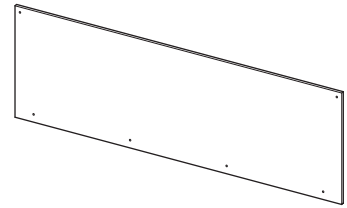

③ Back board

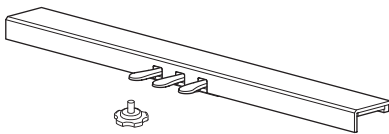

④ Pedal board
Pedal support bolt

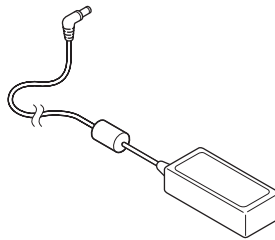

⑤ AC/DC Adaptor

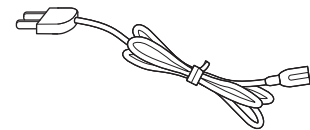

⑥ Power cable

Screw set

⑦ Screw (with flat washer and spring washer)
x 4



⑧ Tapping screw (long, black) x 2



⑨ Tapping screw (short, black) x 8

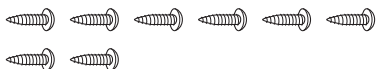

⑩ Headphone hook set x 1

Headphone hook x 1



Mounting screw x 2



Assembly Instructions

1. Assembling the side panels ②, and pedal board ④

Unfasten and extend the pedal connection cable attached to the bottom of the pedal board ④.

Attach the pedal board ④ to the left and right side panels ② using the alignment screws located on either end of the pedal board. Ensure that the correct side panel is used for the left and right side.

Ensure that the pedal board and side panels make close contact, and that there are no large gaps between the assembled parts.

Insert the four short black tapping screws ⑨ into the holes as shown, and securely fasten the pedal board to the and left and right side panels.

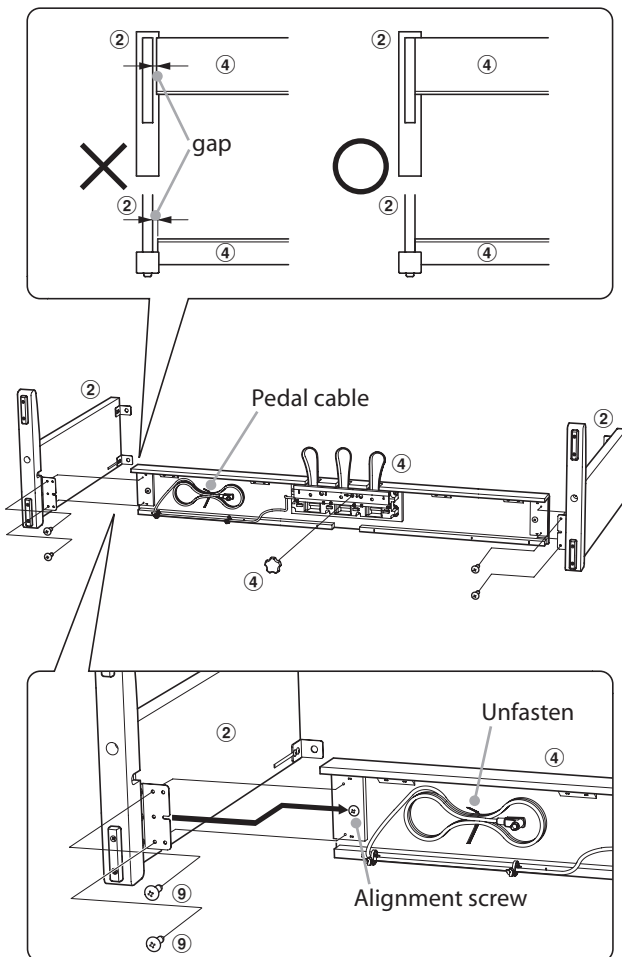

2. Attaching the back board ③

Allow the assembled pedal board and side panels to stand upright (vertically) on the floor.

* Ensure that the adjustor bolt is attached to the pedal board.

Temporarily fix the back board ③ to the left and right side panels using the two long black tapping screws ⑧, leaving a tightening allowance of approximately 1-2 mm.

Then attach the bottom of the back board to the pedal board using the four short black tapping screws ⑨.

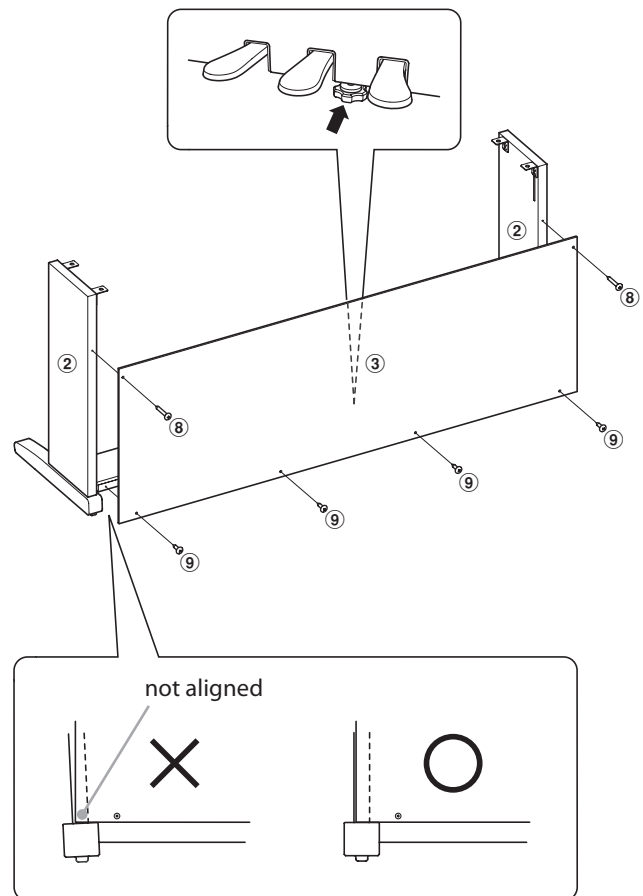

3. Mounting the main body ①



Ensure that two or more people undertake the following step of the assembly process.

Lift the main body ① and carefully place it onto the stand.

Position the main body towards the front of the stand, so that the metal fitting holes are visible when viewed from above.

Gently slide the main body backwards until the base engages with the fixings inside the side panels and locks into place.



When lifting the main body onto the stand, be careful not to catch/trap hands and fingers.

Secure the main body to the stand from below, using the four screws (with the flat washer and spring washer) ⑦.



Tighten all screws securely to ensure that the main body is firmly attached to the stand. Failing to do so may result in serious injury.

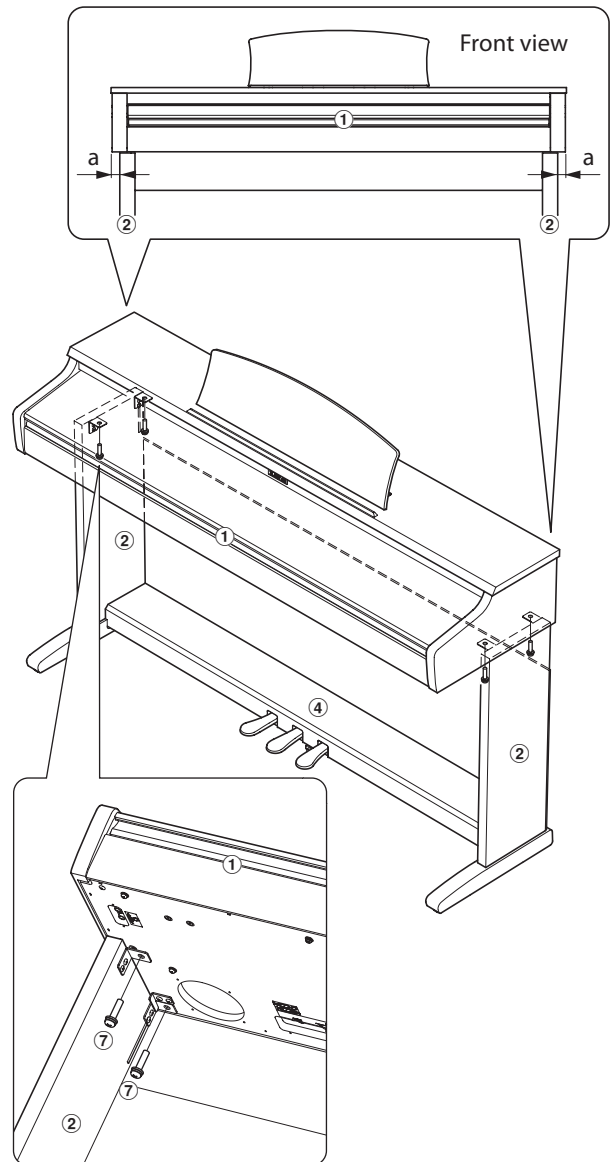
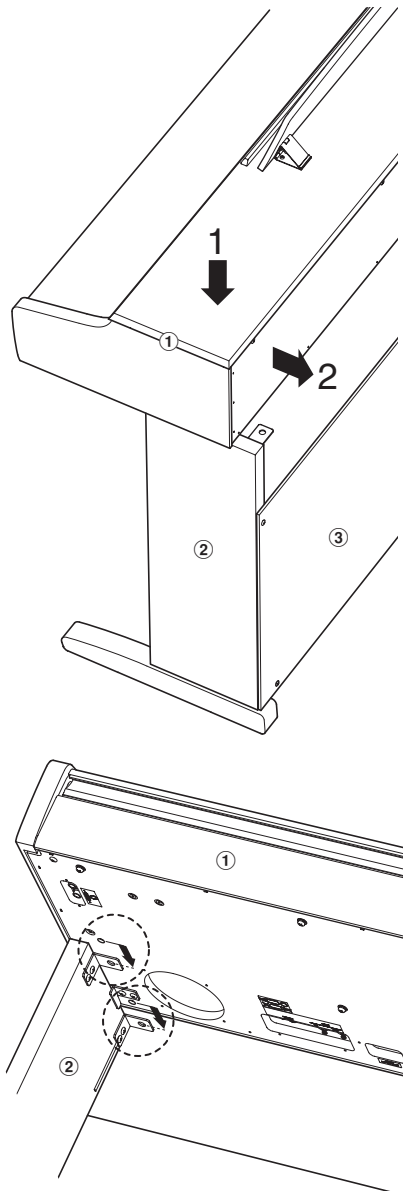

4. Connecting the pedal cable and AC/DC adaptor

Connect the pedal cable to the PEDAL terminal located on the underside of the main body.

Connect the AC/DC adaptor ⑤ to the DC IN terminal.

Use the binders to fix the cables in place.

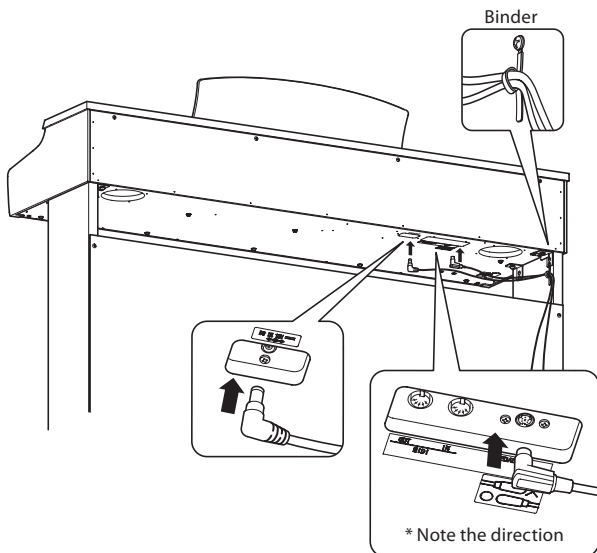

5. Attaching the headphone hook (optional)

If desired, attach the headphone hook to the underside of the main body using the two tapping screws provided.

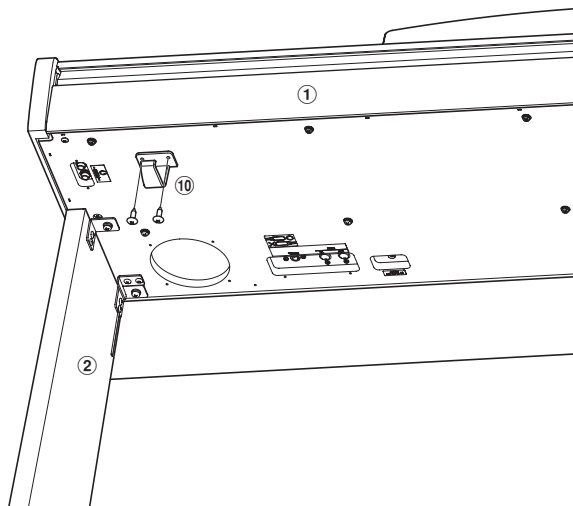

6. Adjusting the pedal support bolt

Turn the pedal support bolt anti-clockwise until it makes contact with the floor and supports the pedals firmly.

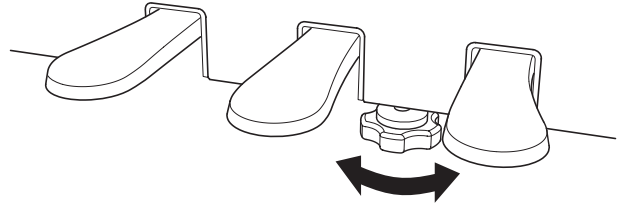

When moving the instrument, always adjust or remove the pedal support bolt, then readjust when the instrument is in its new position.

Demo Song List

Key	No.	Sound Name (Song Title)	Composer
A-1	1	Concert Grand (Hungarian Rhapsodies No.6)	Liszt
B-1	2	Concert Grand 2 (Petit Chien)	Chopin
C0	3	Studio Grand (Original)	Kawai
D0	4	Modern Piano (Original)	
E0	5	Classic E.Piano (Original)	
F0	6	Modern E.Piano (Original)	
G0	7	Jazz Organ (Original)	
A0	8	Church Organ (Chorale Prelude "Wachet auf, ruft uns die Stimme.")	Bach
B0	9	Harpsichord (French Suite No.6)	Kawai
C1	10	Vibraphone (Original)	
D1	11	String Ensemble (Le quattro stagioni: la "Primavera")	Vivaldi
E1	12	Slow Strings (Original)	Kawai
F1	13	Choir (Londonderry Air)	Irish folk song
G1	14	New Age Pad (Original)	Kawai
A1	15	Atmosphere (Original)	

Concert Magic Song List

Key	No.	Song name	Composer
A-1	1	Twinkle, Twinkle, Little Star	French folk song
B-1	2	I'm A Little Teapot	Traditional
C0	3	Mary Had A Little Lamb	American folk song
D0	4	London Bridge	Traditional
E0	5	Row, Row, Row Your Boat	American folk song
F0	6	Frère Jacques	French folk song
G0	7	Old MacDonald Had A Farm	American folk song
A0	8	Hark The Herald Angels Sing	Mendelssohn
B0	9	Jingle Bells	Traditional
C1	10	Deck The Halls	Welsh Air
D1	11	O Come All Ye Faithful	J.Reading
E1	12	Joy To The World	Traditional
F1	13	Silent Night	Traditional
G1	14	We Wish You A Merry Christmas	British folk song
A1	15	Battle Hymn Of The Republic	Traditional
B1	16	Yankee Doodle	American folk song
C2	17	Danny Boy	Irish folk song
D2	18	Clementine	American folk song
E2	19	Auld Lang Syne	Scottish folk song
F2	20	Oh Susanna	S.C.Foster
G2	21	The Camptown Races	S.C.Foster
A2	22	When The Saints Go Marching In	American folk song
B2	23	The Entertainer	S.Joplin
C3	24	William Tell Overture	Rossini
D3	25	Andante from Symphony No.94 (Haydn)	Haydn
E3	26	Für Elise	Beethoven
F3	27	Clair De Lune	Debussy
G3	28	Skater's Waltz	E.Waldteufel
A3	29	Blue Danube Waltz	Strauss
B3	30	Gavotte (Gossec)	Gossec
C4	31	Waltz Of The Flowers	Tchaikovsky
D4	32	Bridal Chorus	Wagner
E4	33	Wedding March	Mendelssohn
F4	34	Pomp And Circumstance	Elgar
G4	35	When Irish Eyes Are Smiling	E.R.Ball
A4	36	Chiapanecas	Mexican folk song
B4	37	Santa Lucia	Naplish folk song
C5	38	Funiculi Funiculà	L.Denza
D5	39	Romance De L'amour	Spanish folk song
E5	40	My Wild Irish Rose	Chauncy Alcote

Lesson Function Song Lists

■ US, Canada, Australasia

Alfred's Basic Piano Library Lesson Book Level 1A

A-1	Right & Left
B-1	Left & Right
C0	Merrily We Roll Along/O'er the Deep Blue Sea
D0	Hand-Bells
E0	Jolly Old Saint Nicholas
F0	Old MacDonald
G0	Batter Up!
A0	My Clever Pup
B0	The Zoo
C1	Playing in a New Position
D1	Sailing
E1	Skating
F1	Wishing Well
G1	Rain, Rain!
A1	A Happy Song
B1	Position C
C2	A Happy Song
D2	See-Saws
E2	Just a Second!
F2	Balloons
G2	Who's on Third?
A2	Mexican Hat Dance
B2	Rock Song
C3	Rockets
D3	Sea Divers
E3	Play a Fourth
F3	July the Fourth!
G3	Old Uncle Bill
A3	Love Somebody
B3	My Fifth
C4	The Donkey
D4	Position G
E4	Jingle Bells!
F4	Willie & Tillie
G4	A Friend Like You
A4	My Robot
B4	Rockin' Tune
C5	Indian Song
D5	Raindrops
E5	It's Halloween!
F5	Horse Sense

Alfred's Basic Piano Library Lesson Book Level 1B

A-1	Step Right Up!
B-1	The Carousel
C0	Hail to Thee, America!
D0	Brother John
E0	Good Sounds
F0	The Cuckoo
G0	Money Can't Buy Ev'rything!
A0	Ping-Pong
B0	Grandpa's Clock
C1	When the Saints Go Marching In
D1	G's in the "BAG"
E1	Join the Fun
F1	Oom-Pa-pa!
G1	The Clown
A1	Thumbs on C!
B1	Waltz Time
C2	Good King Wenceslas
D2	The Rainbow
E2	Good Morning to You!
F2	Happy Birthday to You!
G2	Yankee Doodle
A2	The Windmill
B2	Indians
C3	New Position G
D3	Pedal Play
E3	Harp Song
F3	Concert Time
G3	Music Box Rock
A3	A Cowboy's Song
B3	The Magic Man
C4	The Greatest Show on Earth!
D4	The Whirlwind
E4	The Planets
F4	C Major Scale Piece
G4	G Major Scale Piece
A4	Carol in G Major
B4	The Same Carol in C Major
C5	French Lullaby
D5	Sonatina
E5	When Our Band Goes Marching By!

Lesson Function Song Lists

■ Rest of the World

Burgmüller 25 (25 Etudes Faciles, Opus 100)

A-1	La candeur
B-1	Arabesque
C0	Pastorale
D0	Petite réunion
E0	Innocence
F0	Progrès
G0	Courant Limpide
A0	La gracieuse
B0	La chasse
C1	Tendre fleur
D1	La bergeronnette
E1	Adieu
F1	Consolation
G1	La styrienne
A1	Ballade
B1	Douce plainte
C2	Babillarde
D2	Inquiétude
E2	Ave Maria
F2	Tarentelle
G2	Harmonie des anges
A2	Barcarolle
B2	Retour
C3	L'hirondelle
D3	La chevaleresque

Czerny 30 (Etudes de Mécanisme, Opus 849)

A-1	No. 1
B-1	No. 2
C0	No. 3
D0	No. 4
E0	No. 5
F0	No. 6
G0	No. 7
A0	No. 8
B0	No. 9
C1	No. 10
D1	No. 11
E1	No. 12
F1	No. 13
G1	No. 14
A1	No. 15
B1	No. 16
C2	No. 17
D2	No. 18
E2	No. 19
F2	No. 20
G2	No. 21
A2	No. 22
B2	No. 23
C3	No. 24
D3	No. 25
E3	No. 26
F3	No. 27
G3	No. 28
A3	No. 29
B3	No. 30

■ Lesson Function song book availability

Alfred's Basic Piano Library, Burgmüller: *Etudes Faciles*, and Czerny: *Etudes de Mécanisme* lesson song books are sold separately. Please check your local dealer for more information. Alfred's international offices may also be contacted directly:

USA / Canada

Alfred Music Publishing
 PO Box 10003
 Van Nuys, CA 91410
 Tel: +1 (800) 292-6122
 Email: sales@alfred.com
 Website: <http://www.alfred.com>

Australia

Alfred Publishing Australia
 PO Box 2355
 Taren Point NSW 2229
 Tel: +61 (02) 9524 0033
 Email: sales@alfredpub.com.au

Specifications

■ Kawai KDP90 digital piano

Keyboard	88 weighted keys Advanced Hammer Action IV-F (AHA IV-F)
Sound Source	Harmonic Imaging™ (HI), 88-key piano sampling
Internal Sounds	Concert Grand, Concert Grand 2, Studio Grand, Modern Piano, Classic E.Piano, Modern E.Piano, Jazz Organ, Church Organ, Harpsichord, Vibraphone, String Ensemble, Slow Strings, Choir, New Age Pad, Atmosphere
Polyphony	max. 192 notes
Reverb	Room, Small Hall, Concert Hall
Internal Recorder	3 song recorder - approximately 15,000 note memory capacity
Lesson Function	Alfred or Burgmüller and Czerny lesson songs, depending on market area
Metronome	Beat: 1/4, 2/4, 3/4, 4/4, 5/4, 3/8, 6/8 Tempo: 10-300 bpm
Demo Songs	15 songs
Keyboard Modes	Dual Mode (with adjustable volume balance) Four Hands Mode
Other Functions	Damper Resonance, Reverb, Touch, Tuning, Transpose, Transmit Program Change Number, MIDI Channel, Local Control, Multi-timbral mode
Pedals	Sustain (with half-pedal support), Soft, Sostenuto
Jacks	MIDI (IN/OUT), Headphones × 2
Speakers	12 cm × 2
Output Power	13 W × 2
Power Consumption	15 W
Key Cover	Sliding type
Dimensions	1360 (W) × 403 (D) × 851 (H) mm (folding Music Rack)
Weight	38 kg

MIDI Implementation Chart

■ Kawai KDP90 digital piano

Date : February 2013 Version : 1.0

Function		Transmit	Receive	Remarks
Basic channel	At power-up	1	1	
	Settable	1 - 16	1 - 16	
Mode	At power-up	Mode 3	Mode 1	** Omni mode is on at power-up. Omni mode can be turned off through MIDI channel setting operations.
	Message	×	Mode 1, 3**	
	Alternative	*****	×	
Note number	Range	15 - 113*	0 - 127	* 15 - 113, including transpose
		*****	0 - 127	
Velocity	Note on	○	○	
	Note off	×	×	
After touch	Key specific	×	×	
	Channel specific	×	×	
Pitch bend		×	×	
Control change	7	×	○	Volume
	64	○ (Right pedal)	○	Damper pedal
	66	○ (Middle pedal)	○	Sostenuto pedal
	67	○ (Left pedal)	○	Soft pedal
Program change settable range		○ (0 - 127)	○ (0 - 127)	

Exclusive		○	○	Transmission can be selected
Common	Song position	×	×	
	Song selection	×	×	
	Tune	×	×	
Real time	Clock	×	×	
	Commands	×	×	
Other functions	Local On / Off	×	○	
	All notes Off	×	○	
	Active sensing	×	○	
	Reset	×	×	
Remarks				

Mode 1: omni mode On, Poly
Mode 3: omni mode Off, Poly

Mode 2: omni mode On, Mono
Mode 4: omni mode Off, Mono

○ : Yes
× : No

SOUND

Dual Balance

Large
Medium
Small

On
Off

Damper Resonance
(For Concert Grand 1/2, Studio Grand, Modern Piano only)

On
Off

Reverb

On
Off

Concert Hall
Small Hall
Room

Touch

Heavy
Normal
Light

Tuning
(427Hz ~ 453Hz)

440 Hz
-0.5 Hz
+0.5 Hz

Transpose
(-6 ~ +5)

On
Off

Sound Select
(Dual Mode = Two keys)

A-1	B-1	C0	D0	E0	F0	G0	A0	B0	C1	D1	E1	F1	G1	A1	B1	C2	D2	E2	F2	G2	A2	B2	C3	D3	E3	F3	G3	A3	B3	C4	D4	E4	F4	G4	A4	B4	C5	D5	E5	F5	G5	A5	B5	C6	D6	E6	F6	G6	A6	B6	C7
																1	2	3	4	5	6	7	8	9	0																										

Tuning Value (3 digits)

METRONOME

Time Signature

1/4
2/4
3/4
4/4
5/4
3/8
6/8

Metronome Volume

+

Concert Magic Mode

1 2

Metronome Tempo (2 or 3 digits)

A-1	B-1	C0	D0	E0	F0	G0	A0	B0	C1	D1	E1	F1	G1	A1	B1	C2	D2	E2	F2	G2	A2	B2	C3	D3	E3	F3	G3	A3	B3	C4	D4	E4	F4	G4	A4	B4	C5	D5	E5	F5	G5	A5	B5	C6	D6	E6	F6	G6	A6	B6	C7
																1	2	3	4	5	6	7	8	9	0																										

Metronome Tempo (2 or 3 digits)

Concert Magic

Concert Magic Mode

1 2

Song Select

A-1	B-1	C0	D0	E0	F0	G0	A0	B0	C1	D1	E1	F1	G1	A1	B1	C2	D2	E2	F2	G2	A2	B2	C3	D3	E3	F3	G3	A3	B3	C4	D4	E4	F4	G4	A4	B4	C5	D5	E5	F5	G5	A5	B5	C6	D6	E6	F6	G6	A6	B6	C7
																1	2	3	4	5	6	7	8	9	0																										

40	My Wild Irish Rose
39	Romance De L' amour
38	Funiculi Funicula
37	Santa Lucia
36	Chiapanecas
35	When Irish Eyes Are Smiling
34	Pomp And Circumstance
33	Wedding March
32	Bridal Chorus
31	Waltz Of The Flowers
30	Gavotte (Gossec)
29	Blue Danube Waltz
28	Skater's Waltz
27	Clair De Lune
26	Für Elise
25	Andante from Symphony No.94 (Haydn)
24	William Tell Overture
23	The Entertainer
22	When The Saints Go Marching In
21	The Camptown Races
20	Oh Susanna
19	Auld Lang Syne
18	Clementine
17	Danny Boy
16	Yankee Doodle
15	Battle Hymn Of The Republic
14	We Wish You A Merry Christmas
13	Silent Night
12	Joy To The World
11	O Come All Ye Faithful
10	Deck The Halls
9	Jingle Bells
8	Hark The Herald Angels Sing
7	Old MacDonald Had A Farm
6	Frère Jacques
5	Row, Row, Row Your Boat
4	London Bridge
3	Mary Had A Little Lamb
2	I'm A Little Teapot
1	Twinkle, Twinkle, Little Star

LESSON

Selecting a Lesson book and song

Book 2 *

Song Number

*Press this key before selecting the song to select Book 2

Listening to the song

Selecting the part to practice

Press once:
Left-hand only

Press twice:
Right-hand only

Press 3 times:
Both Left and Right hands

RECORDER

Record song

① Enter recording mode.

② Select a song memory

③ Start recording

Play song

Erase all songs

① Hold both buttons

② Turn the power on

MIDI

Transmit MIDI Program Change

Program Number (3 digits)

MIDI Channel

MIDI Channel

MIDI Local Control

Multi-timbral Mode

Auto Power Off

30 min.

60 min.

120 min.

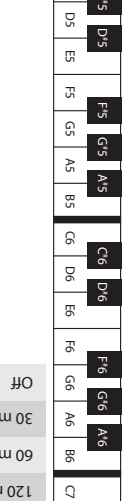
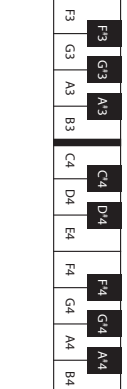
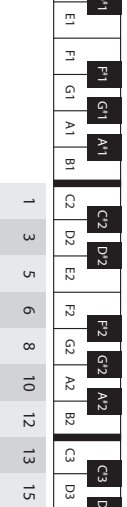
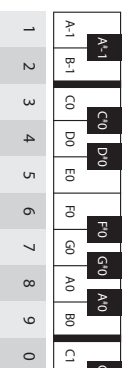
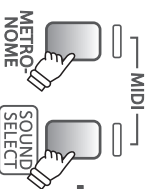

KAWAI

THE FUTURE OF THE PIANO

KDP90 Owner's Manual
KPSZ-0641
OW1072E-S1304

Printed in Indonesia

Copyright © 2013 Kawai Musical Instruments Mfg. Co.,Ltd. All Rights Reserved.



817855-R100