



LSR4328P

Linear Spatial Reference Bi-amplified Studio Monitor

Key Features:

- ▶ Advanced LSR Linear Spatial Reference Design provides neutral off-axis response for greater clarity at the mix position
- ▶ Automated RMC™ Room Mode Correction system with calibration microphone measures and automatically compensates for low frequency standing waves and boundary conditions.
- ▶ Harman HiQnet™ Network Protocol enables system-wide control of level, EQ, input selection, solo and more
- ▶ Wireless remote control and LSR4300 Control Center Software enable control from the listening position.
- ▶ AES/EBU, S/PDIF digital inputs
- ▶ Balanced analog input with selectable +4dBu / -10 dBV sensitivity.
- ▶ Bi-amplified design eliminates the need for external amplification.
- ▶ Front panel output meter with variable brightness displays signal level.
- ▶ Custom designed, self-shielded transducers with neodymium motor structures for exceptional transient response and superb power-handling.
- ▶ Integrated mounting points allow wall mounting for greater placement options
- ▶ Built-in handles facilitate optimum positioning.
- ▶ Low and High Frequency Equalization with factory presets allows tailoring of response to preference, or acoustic conditions in the room.

The LSR4300 Series Studio Monitors are designed for critical stereo and multi-channel audio production applications that require exceptional spectral accuracy and high SPL capability. Acknowledging that much of today's production is carried out in acoustically untreated rooms, the LSR4300 Series is the first professional monitor to combine JBL's Linear Spatial Reference technology and automated RMC™ Room Mode Correction, an onboard system that automatically compensates for low frequency anomalies measured at the mix position. The LSR4300 enhances computer-based production by incorporating system-wide volume control, input source selection, individual speaker solo and user EQ. Harman HiQnet™ Network protocol enables centralized system-wide control from any speaker, wireless remote control and computer using LSR4300 Control Center Software.



438H Low Frequency Transducer

The 8" woofer utilizes a powerful, shielded neodymium magnet of light weight which can be used in close proximity to CRT-type monitors with no interference. The transducer utilizes a copper-clad polepiece that improves high frequency output by reducing voice coil inductance. A copper ribbon voice coil ensures high sensitivity, and a flux shorting ring stabilizes the magnetic field in the gap, reducing distortion. Heat sinking has been placed close to the magnetic gap in order to draw out heat as efficiently as possible. The cone is polymer coated for uniformity of response over the woofer's passband.

431G High Frequency Transducer

The high frequency transducer has a treated silk diaphragm that produces uniform and smooth sound. Its flat ribbon aluminum voice coil ensures low moving mass and enables the transducer to achieve response out to 22 kHz. A light weight neodymium magnet structure with integral heat sinking, along with Ferrofluid in the magnetic gap, enable the transducer to produce high peak output levels with minimal power compression. The magnet structure is integrally shielded, enabling the system to be used in proximity to CRT-type monitors with no interference.

Bi-amplified Power System

The LSR4328P incorporates two high power amplifiers that provide 150 Watts of power to the low frequency transducer and 70 Watts of power to the high frequency transducer. A precision digital dividing network having high-order Linkwitz-Riley slope characteristics for smooth transition between transducers, results in exceptional imaging and lack of time smear. The circuitry also yields a tonal-artifact-free noise floor.

Network and Digital Features

The LSR4300 Series utilizes the Harman HiQnet™ network protocol that allows centralized control of a multi-channel system from a from any speaker's front panel, wireless remote control, or computer via a standard USB connection and LSR4300 Control Center Software. The network is configured using supplied CAT5 cable and by setting a DIP switch on each speaker. Harman HiQnet also enables synchronized RMC calibration of all speakers on the network.

► LSR4328P Linear Spatial Reference Bi-amplified Studio Monitor

Automated RMC™ Room Mode Correction System

Room modes” (sometimes called “standing waves”) can produce a low frequency resonance that gives a misleading impression of bass response at the listening position. RMC™ (short for “Room Mode Correction”) in the LSR4300 series automatically analyzes the frequency response of the speakers at the listening position and automatically applies a corrective filter to minimize low frequency resonance. When the calibration mic is connected and the RMC analysis is initiated, the LSR4300 RMC system applies

a parametric filter at any of 73 frequencies (1/24th octave centers) between 20 Hz and 160 Hz, with a variable Q from 1 (1.4 octave bandwidth) to 16 (1/11th octave bandwidth), with 3 to 12 dB of attenuation.

During the RMC calibration process, speaker levels are trimmed in 0.25 dB increments so that all speakers in the system produce equal SPL (sound pressure level) at the mix position.

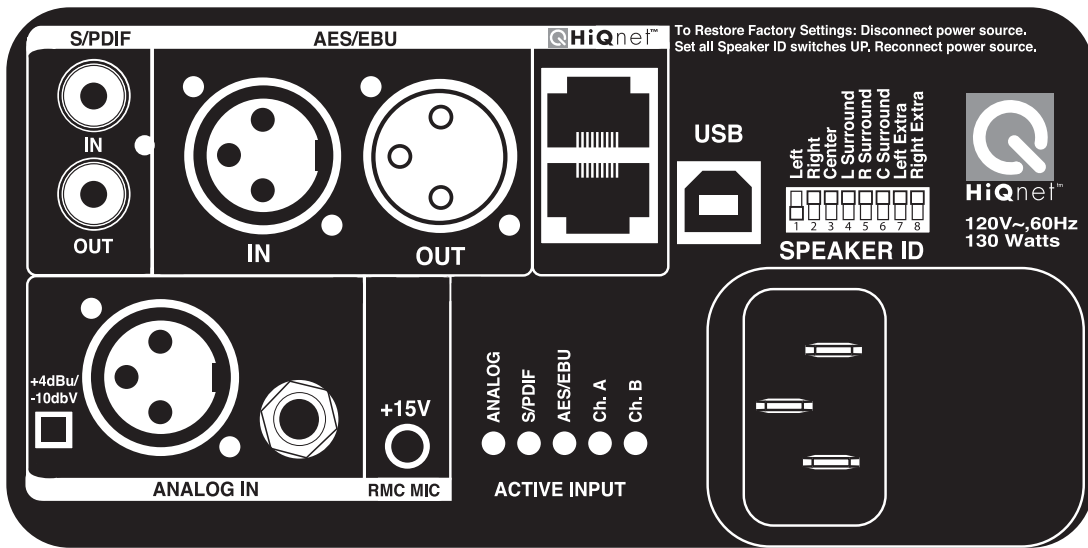

Linear Spatial Reference Design and Measurement Techniques

We all know that many loudspeakers have similar measurements but sound different. By going beyond simple on-axis frequency response measurements, JBL defines the ultimate performance specification for new systems – what it will sound like in your room. While other manufacturers use a single on-axis frequency response measurement taken at one point in space, JBL measures monitor systems over a sphere that encompasses all power radiated into the listening room – in every direction. This data reflects 1296 times the information of a single on-axis response curve. Seventy-two measurements of the direct

sound field, the reflected sound field, and the reverberant field, the entire sound field heard by the listener, is correlated to optimize response at the listening position. In place of spectral smoothing used by some manufacturers, which actually conceals data, the JBL approach actually exposes flaws in systems, such as resonances, poor dispersion and other causes of off-axis coloration. The data shown below is a set of spatially measured graphs that are the heart of JBL’s philosophy.

LSR4328P Response Curves

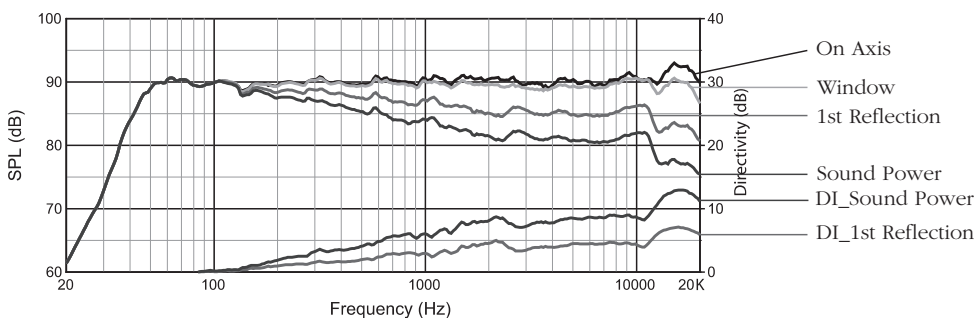

Specifications:

System:	
Frequency Response (+/- 1.5 dB):	50 Hz – 20 kHz
Enclosure Resonant Frequency:	41 Hz
Low Frequency Extension:	User controls set to default
-3 dB:	43 Hz – 22 kHz
-10 dB:	35 Hz – 32 kHz
Low-High Frequency Crossover:	Digital Crossover: 2.2 kHz, 8th order LR LF/3rd order BW HF
Distortion, 96 dB SPL, 1 m:	
Mid-High Frequency (200 Hz - 20 kHz)	
2nd Harmonic:	<0.4%
3rd Harmonic:	<0.3%
Low Frequency (<200 Hz)	
2nd Harmonic:	<1.5%
3rd Harmonic:	<0.7%
Measured Maximum Continuous SPL:	106 dB / 1m
Measured Maximum Peak SPL:	112 dB / 1m
Maximum Peak SPL Per Pair:	118 dB SPL / 1m
Low Frequency Model:	438H
Diameter:	203 mm (8 in)
Voice Coil:	2" (51 mm)
Magnet Type:	Neodymium
Cone Type:	Polymer coated paper fiber
Impedance:	8 ohms
High Frequency Model:	431G
Diameter:	25 mm (1 in) diaphragm
Voice Coil:	1" (25 mm)
Magnet Type:	Neodymium, shielded with integral heat sink
Diaphragm Type:	Silk Dome
Other Features:	Elliptical oblate spheroidal waveguide
Impedance:	4 ohms
Amplifier	
Low Frequency Topology:	Class A-B Monolithic, Balanced
Sine Wave Power Rating:	150 watts (<0.1% THD into rated impedance)
THD + N, _ Power:	<0.02%
High Frequency Topology:	Class A-B Monolithic
Sine Wave Power Rating:	70 watts (<0.1% THD into rated impedance)
THD + N, _ Power:	<0.02%
AC Input Voltage:	115 VAC, 60 Hz (230VAC, 50 Hz – models LSR4328P/230 and LSR4326P/230)
AC Input Connector:	IEC
Self-Generated Noise Level:	<13 dBA / 1 m tonal artifact-free noise floor using analog input
1/8TH Power Rating:	18 watts LSR4328P
Full Power Rating (100 hrs. IEC pink noise, 6dB crest Factor):	58 watts IEC Pink Noise LF Channel Only
Wattage Rating:	AC at 1/8th power IEC Pink Noise 60 watts
Maximum Current:	AC at maximum power output (audio) 120V AC line 2.2A (LSR4328P, LSR4326P) 230V AC line 1.1A (LSR4328P/230, LSR4326P/230)
Fuse Value:	5A, 250VAC, Time Lag (LSR4328P, LSR4326P) 2.5A, 250VAC, Time Lag (LSR4328P/230, LSR4326P/230)
Inputs and Outputs	
Analog	
XLR IN:	Selectable +4 dBu/-10 dBV; Input Impedance 10K. Positive voltage applied to XLR pin 2 produces outward woofer motion
¼-in tip-ring-sleeve IN:	Balanced or unbalanced, Selectable +4 dBu/-10 dBV; Input impedance 20K. Positive voltage applied to ¼" tip produces outward woofer motion
AD Converters:	96kHz, 24 Bit, 64x Over sampling
Calibrated Input Sensitivity, Analog XLR & ¼":	
+4 dBu:	94 dB SPL / 1 m
-10 dBV:	94 dB SPL / 1 m
Digital	
XLR IN:	AES/EBU (IEC60958)
XLR OUT:	AES/EBU (IEC60958)
RCA IN:	S/PDIF (EIAJ CP1201)
RCA OUT:	S/PDIF (EIAJ CP1201)
Digital Input Sample Rates:	96k Hz, 88.2 kHz, 48 kHz, 44.1 kHz, 32 kHz. Tolerance: +/- 3%
Digital Input Word Length:	24 Bit
RMC Microphone Input (Use supplied microphone only)	½" tip-ring-sleeve; powered +15 Volts on tip.
Network Connection:	RJ45 IN, RJ45 OUT
Network Protocol:	Proprietary Harman HiQNet™ Protocol using RS485
Computer Interface:	USB Type 1

User Controls	
Front Panel Controls:	ON, SOLO, RMC, EQ ON, LE HF, PRESET, INPUT, +/-
RMC Functions:	Start, Bypass
RMC Filter Range:	73 Frequencies (1/24th octave centers) between 20 Hz to 160 Hz, with a variable Q from 1 (1.4 octave bandwidth) to 16 (1/11th octave bandwidth, and from 3 to 12 dB of attenuation).
LF EQ: Factory Default:	500 Hz Shelf, +/- 2dB in _ dB increments. 137 corner frequencies between 19.7 Hz and 1kHz accessible via LSR4300 Control Center Software
HF EQ:	Factory Default: 2kHz Shelf, +/- 2dB in _ dB increments 104 corner frequencies between 1kHz and 20.2 kHz accessible via LSR4300 Control Center Software
PRESET:	1-6 Factory/User plus NULL. Recall only. STORE possible using LSR4300 Control Center Software.
INPUT Selection:	Analog (XLR / ¼") S/PDIF A, B AES/EBU A, B
+/-	Default: System Volume Control: 0 dB to -∞ dB Secondary functions: Increment/decrement value of selected function
Rear Panel Controls:	Input sensitivity +4dBu/-10dBV
Additional Controls via LSR4300 Control Center Software:	Eight SPEAKER ID DIP switches: Left, Right, Center, Left Surround, Right Surround, Center Surround, Left Extra, Right Extra DIM (-12 dB at full volume), System MUTE, Preset STORE, LOAD Configuration, SAVE Configuration, Level TRIM +3 dB to -10 dB in ¼ dB increments
Display	
Front Panel Display:	31 LED Segments for dBFS and indication of settings
Front Panel Meter:	-70 dBFS to 0 dBFS plus CLIP
Rear Panel Indicators:	5 LEDs indicate Active input & digital stream selection
Physical	
Finish:	Dark graphite
Handles:	Two, flush mounted on sides
Mounting:	4 threaded mounting points conforming to industry standard square pattern, 107.9 mm x 50.8 mm (4 ¼" x 2") center to center. M6 metric threads. Not for suspension! Only Placement on Bracket
Low Frequency Vent:	Rear ported linear dynamics aperture
Baffle Construction:	Injection-molded structural ABS
Enclosure Construction:	19 mm (¾ in) MDF
Net Weight:	15 kg (32.5 lbs)
Dimensions (WxHxD):	267 mm x 438 mm x 269 mm (10.5" x 17.25" x 10.6")

Notes:

All measurements unless otherwise stated made anechoically in a 4π environment at 2 meters, referenced to 1 meter by inverse square law.

The reference measurement microphone position is located perpendicular to the centerline of the low and high frequency transducers at the point 63.5 mm (2.5 in) below the center of the high frequency diaphragm.

Acoustic loading provided by the listening room increases maximum SPL capability and low frequency bass extension as compared to stated anechoic values.

Distortion measurements performed with the input voltage necessary to produce the stated A-weighted SPL at the stated measurement distance. Distortion figures refer to the maximum distortion measured in any 1/10th octave wide band in the stated frequency range.

JBL continually engages in research related to performance improvements. New materials, production methods, and design refinements are introduced into existing products without notice as a routine expression of that philosophy. For this reason, any current JBL product may differ in some respect from its published description, but will always equal or exceed the original design specification unless otherwise stated.

Mounting points

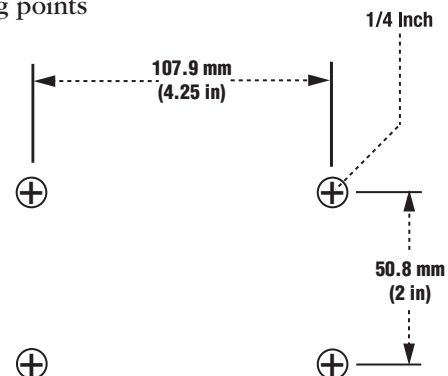

Caution: Unsafe mounting or overhead suspension of any heavy load can result in serious injury and equipment damage. Mounting of speakers should be done by qualified persons in accordance with all applicable local safety and construction standards. Be certain to follow the instructions provided by the manufacturer of the mounting bracket. Before selecting a mounting bracket, be certain that it is capable of supporting the weight of the speaker to be mounted. This product is not designed to be suspended using mounting points.

► LSR4328P Linear Spatial Reference Bi-amplified Studio Monitor

Acoustic Contribution

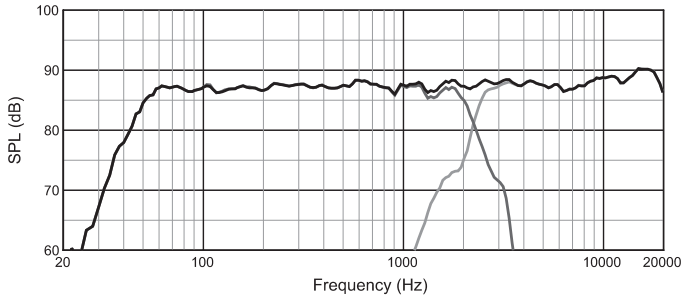

Phase and Amplitude

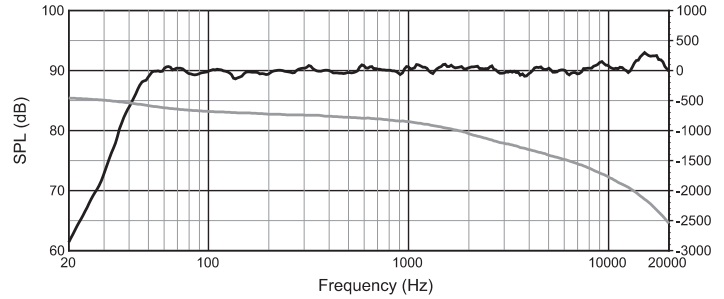

96 dB/1 m (Distortion raised 20 dB)

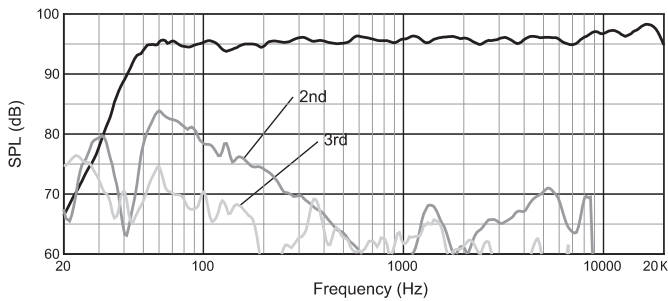

Impulse response

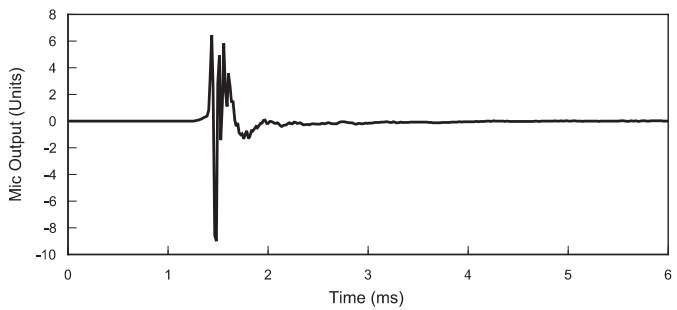

102 dB/1 m (Distortion raised 20 dB)

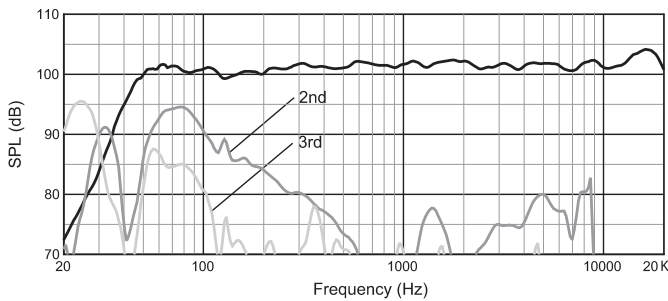

System Block Diagram

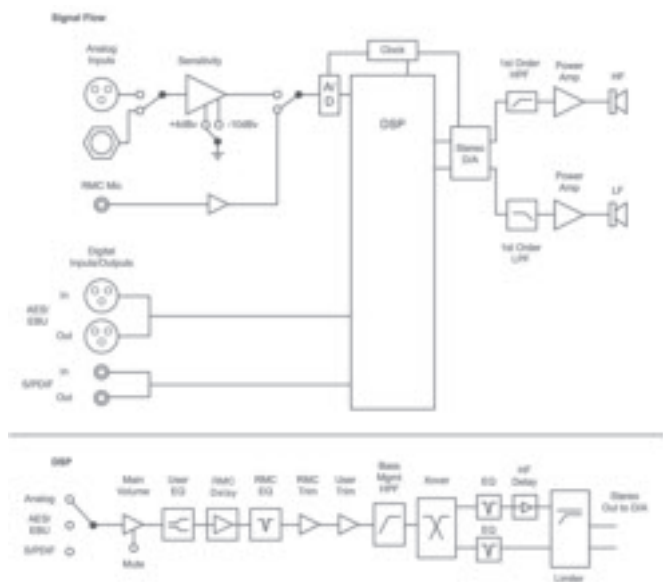

LSR4300 Accessory Kit



Includes: Wireless Remote Control, LSR4300 Control Center Software, RMC Calibration Microphone & Mic Clip, USB Cable, two AA Batteries, 2 Network Termination Plugs

LSR4300 Control Center Software System Requirements:

- Windows: OS: Windows 2000, XP
- CPU: P3 500 MHz (1.0 GHz recommended)
- Macintosh: OS: OS X 10.3 or later
- CPU: 466 MHz or faster
- Hard Drive: 100 MB available
- RAM: 128 MB (512 MB recommended)
- USB Port



JBL Professional
8500 Balboa Boulevard, P.O. Box 2200
Northridge, California 91329 U.S.A.

A Harman International Company
© Copyright 2006 JBL Professional

SS LSR4328P
CRP 5M
1/06