

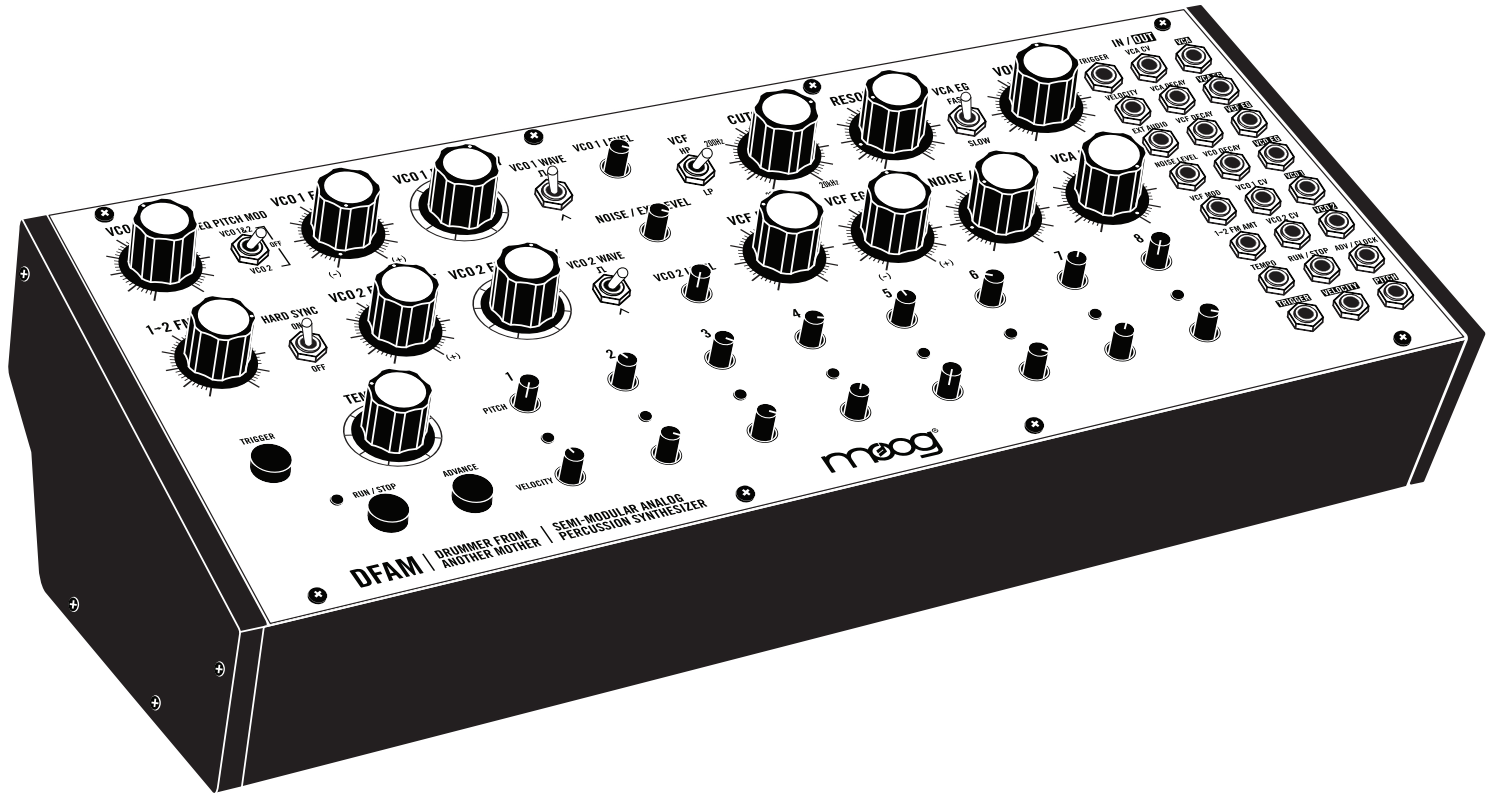

**DFAM™ | DRUMMER FROM  
ANOTHER MOTHER™**

---

USER'S MANUAL



“I’m 100% sure that things like this  
(synthesizer), even though they’re not living  
in the biological sense, there is in some  
sense a consciousness that we connect with.”

**- Dr. Robert Moog -**

## IMPORTANT SAFETY INSTRUCTIONS

### **WARNING - WHEN USING ELECTRIC PRODUCTS, THESE BASIC PRECAUTIONS SHOULD ALWAYS BE FOLLOWED:**

1. Read all the instructions before using the product.
2. Do not use this product near water - for example, near a bathtub, washbowl, kitchen sink, in a wet basement, or near a swimming pool or the like.
3. This product, in combination with an amplifier and headphones or speakers, may be capable of producing sound levels that could cause permanent hearing loss. Do not operate for a long period of time at a high volume level or at a level that is uncomfortable.
4. The product should be located so that its location does not interfere with its proper ventilation.
5. The product should be located away from heat sources such as radiators, heat registers, or other products that produce heat. No naked flame sources (such as candles, lighters, etc.) should be placed near this product. Do not operate in direct sunlight.
6. The product should be connected to a power supply only of the type described in the operating instructions or as marked on the product.
7. The power supply cord of the product should be unplugged from the outlet when left unused for a long period of time or during lightning storms.
8. Care should be taken so that objects do not fall and liquids are not spilled into the enclosure through openings.

*There are no user serviceable parts inside. Refer all servicing to qualified personnel only.*

**NOTE:** This equipment has been tested and found to comply with the limits for a Class B digital device, pursuant to Part 15 of the FCC rules. These limits are designed to provide reasonable protection against harmful interference in a residential installation. This equipment generates, uses, and can radiate radio frequency energy and, if not installed and used in accordance with the instructions, may cause harmful interference to radio communications. However, there is no guarantee that interference will not occur in a particular installation. If this equipment does cause harmful interference to radio or television reception, which can be determined by turning the equipment off and on, the user is encouraged to try to correct the interference by one or more of the following measures:

- Reorient or relocate the receiving antenna.
- Increase the separation between the equipment and receiver.
- Connect the equipment to an outlet on a circuit different from that to which the receiver is connected.
- Consult the dealer or an experienced radio/TV technician for help.

**CAUTION:** Please note that any changes or modifications made to this product not expressly approved by Moog Music Inc. could void the user's authority granted by the FCC to operate the equipment.

## **TABLE OF CONTENTS**

### **06 UNPACKING & INSPECTION**

### **06 SETUP & CONNECTIONS**

### **07 DFAM OVERVIEW**

07 Signal Flow

08 Exploring The DFAM

### **13 PANEL CONTROLS & FUNCTIONS**

13 Voltage Controlled Oscillators

16 Mixer

17 Voltage Controlled Filter

20 Voltage Controlled Amplifier

22 Analog 8-Step Sequencer

24 Patchbay

### **30 SYNCING MULTIPLE DFAMS**

#### **31 SYNCING DFAM WITH A MOTHER-32**

### **32 USING DFAM AS A EURORACK MODULE**

### **33 PRESETS & PATCH SHEETS**

### **40 SPECIFICATIONS & ACCESSORIES**

### **41 SERVICE & SUPPORT INFORMATION**

## UNPACKING AND INSPECTION

Be careful when unpacking your new Drummer From Another Mother so that nothing is lost or damaged. We recommend saving the carton and all packing materials in case you ever need to ship the instrument for any reason.

The Moog DFAM ships with the following items:

1. DFAM Semi-Modular Analog Percussion Synthesizer
2. Power Supply
3. Owner's Manual
4. Overlays
5. Patch Cables
6. Registration Card

What you will need:

1. Headphones with a 1/4" TRS plug, or a 1/4" TS instrument cable and an amplified speaker.
2. A properly wired AC outlet.

## SETUP AND CONNECTIONS

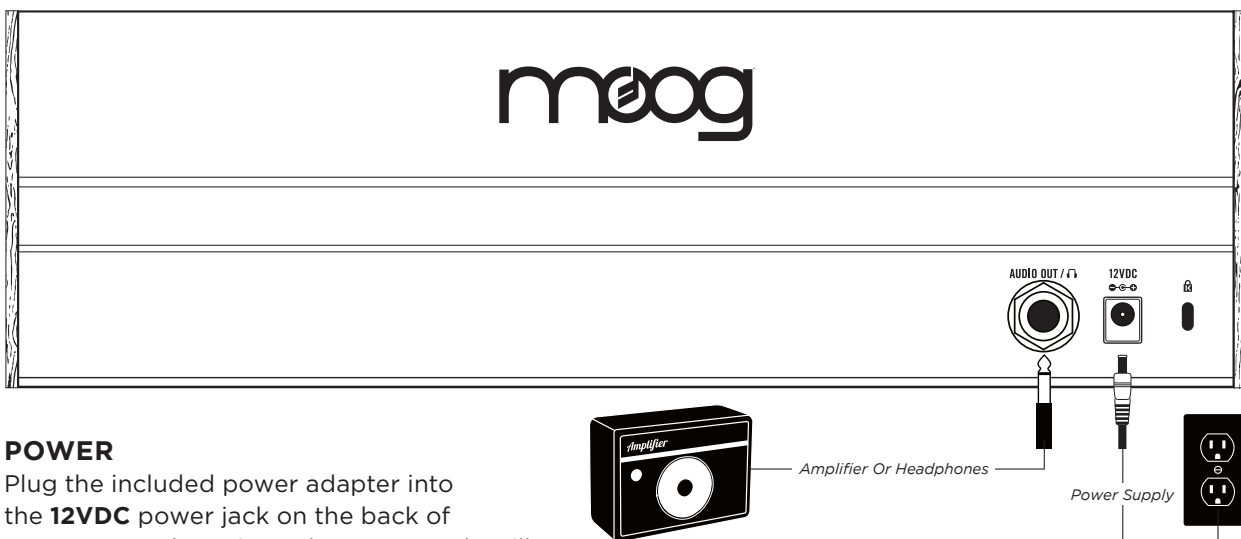

### POWER

Plug the included power adapter into the **12VDC** power jack on the back of your DFAM. *The universal power supply will operate with a power source from 100 to 240 Volts AC, 50/60Hz.* Plug the other end of the included power adapter into an AC outlet.

**NOTE:** There is no power switch on your DFAM. Once connected to the power supply, the unit is **ON**. Your DFAM is an all-analog instrument and should be allowed a few minutes to warm up before use. In cases where it has been left in a cold car overnight, for example, it may take even longer for the oscillator tuning to stabilize. Do not operate your DFAM in direct sunlight.

### AUDIO OUT / 1/4"

With the Master **VOLUME** knob turned all the way down, plug one end of a 1/4" TS instrument cable into the **AUDIO OUT** jack on the rear panel. Then plug the other end into an amplified speaker or mixing console input. This jack can also be used with a set of mono or stereo headphones.

**WARNING:** Do not use a TRS (balanced) cable for line output applications as this will cause phase cancellation and a very weak signal.

# DFAM OVERVIEW

Your new Drummer From Another Mother (DFAM) is a highly-interactive, Semi-Modular Analog Percussion Synthesizer and a vibrant deviation from the traditional drum machine. As an addition to the Mother-32 family of Semi-Modular Analog Synthesizers, DFAM presents a uniquely expressive hands-on approach to percussive pattern creation.

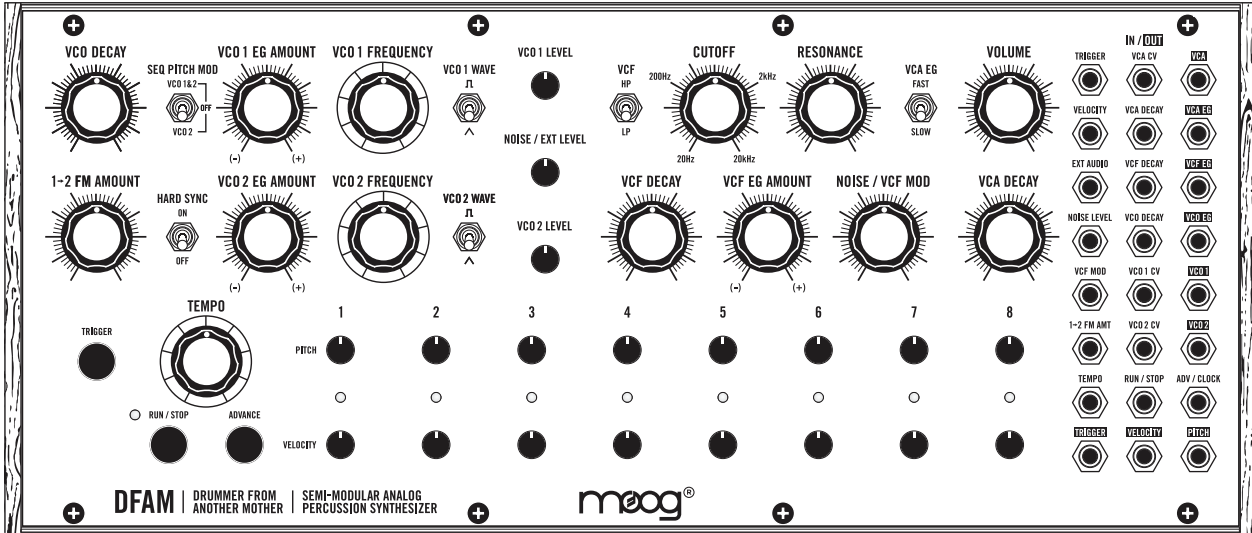

## SOUND SOURCES

Two Voltage Controlled Oscillators and a White Noise Generator

## SOUND BLENDING

3-Channel Mixer

## SOUND SHAPING

Selectable 4-pole Low Pass or High Pass Ladder Filter

## MODULATION

3 Envelope Generators with Voltage Controlled Decay

## SEQUENCING

8-Step Analog Sequencer with Variable Pitch and Velocity per step

## PATCHING

24-point Modular Patchbay with 15 inputs and 9 outputs

# DFAM SIGNAL FLOW

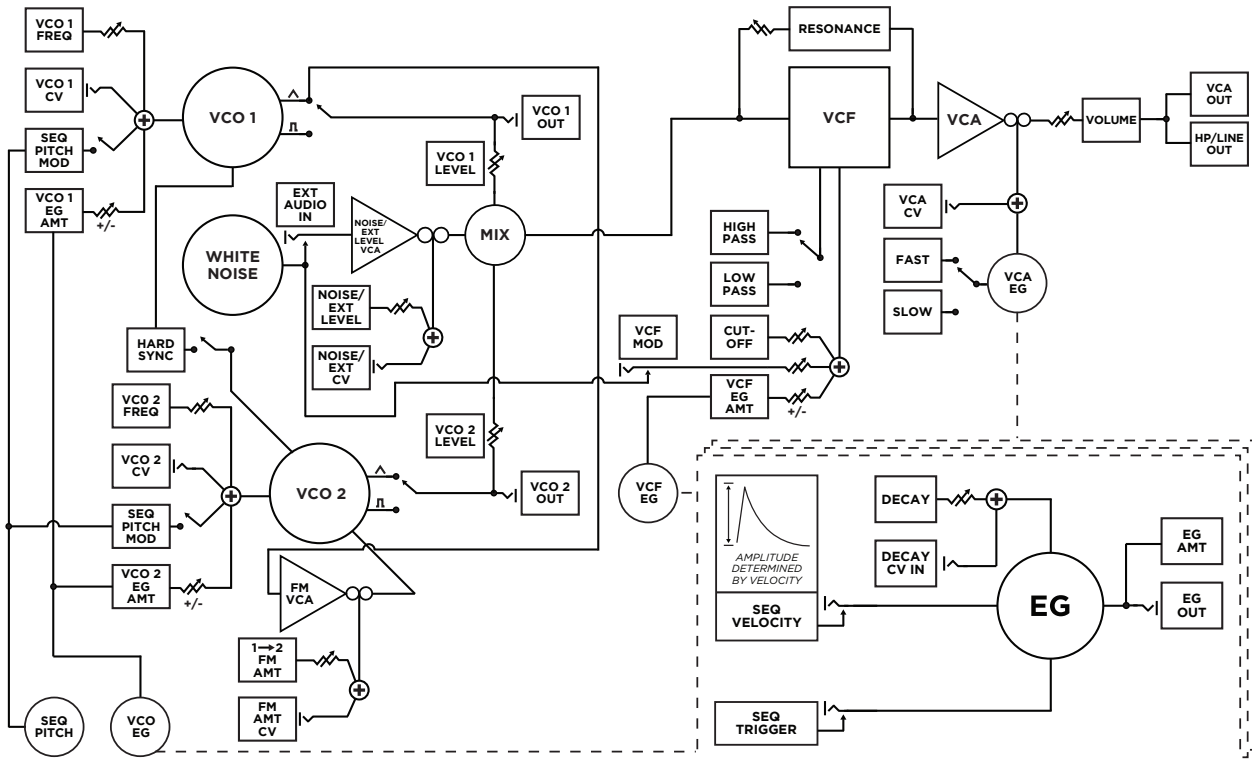

# EXPLORING THE DFAM

This hands-on tour of your DFAM will give you a basic foundation with which visceral rhythms can be synthesized. There are loads of tips, tricks and patching suggestions contained within this manual, but if you want to just jump to making cool sounds – go to page 33.

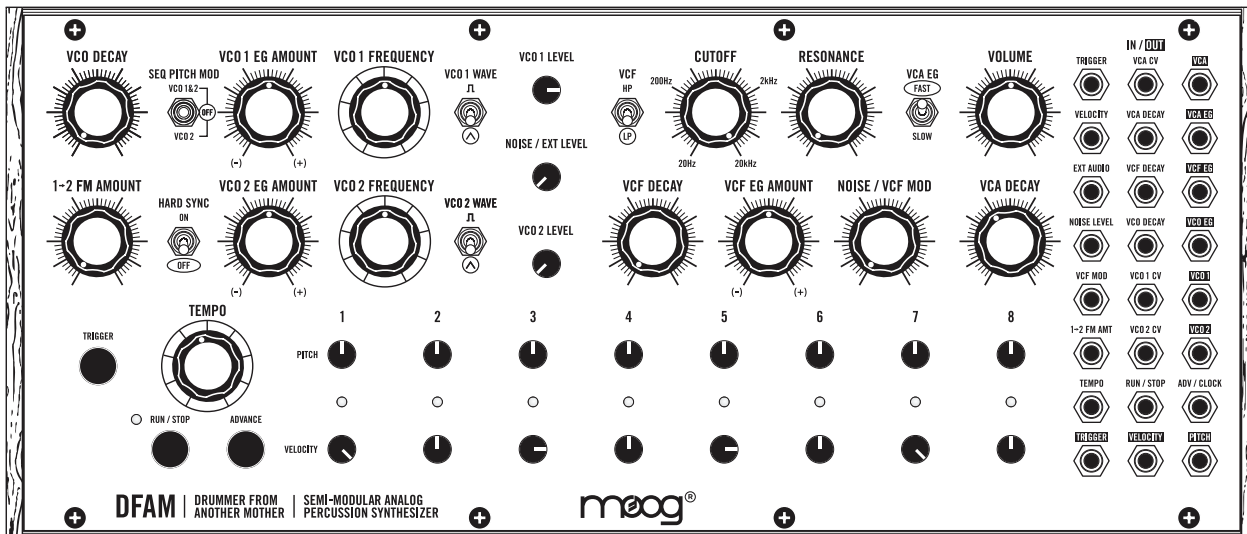

## DEFAULT SETTINGS

Start by setting your DFAM to the Default settings shown above.

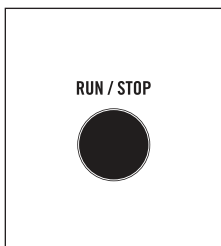

### START THE SEQUENCER

Push the **RUN / STOP** button to start the Sequencer.

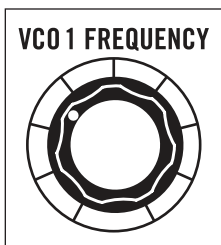

### SET THE PITCH

Turn the **VCO 1 FREQUENCY** knob slowly to the left until you hear a nice, deep bass note repeating (Somewhere between 10 and 11 O'clock). This is how you set the starting pitch for an Oscillator.

**NOTE:** *DFAM has two Oscillators, which are its primary sources of sound. It has a White Noise Generator too, but we'll get to that later.*

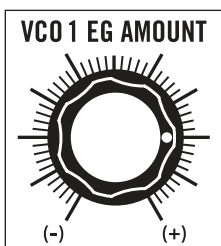

### ADDING PUNCH

Now, let's add some punch to that bass note. Turn up the **VCO 1 EG AMOUNT** knob to 3 O'clock. This adds Envelope Modulation to the Pitch of Oscillator 1.



## EXPLORING THE DFAM *(Continued)*

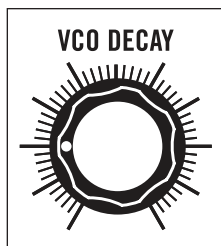

### GET THE PITCH JUMPING

The **VCO DECAY** knob is going to add some more motion to the pitch of the note. It works in conjunction with the position of the **VCO EG AMOUNT** knobs. Try turning the **VCO DECAY** knob up slowly and listen to how it affects the sound. When you're done experimenting, set this knob to 9 O'clock.

**TIP:** The **VCO EG AMOUNT** knob plays an extremely important role in how the DFAM sounds and behaves. It is the difference between a silly sound and a slamming kick drum. Take some time to rotate the **VCO 1 EG AMOUNT** knob and listen to how it changes the character of a sound. When you are done, be sure to set it back to 3 O'clock.

### SEQUENCER VELOCITY



Turn all 8 Sequencer **VELOCITY** knobs to their maximum position. Notice how every hit now sounds the same.

### RHYTHMIC VARIATION



Make some adjustments to all 8 of the Sequencer **VELOCITY** knobs and listen to how they affect both the volume and punch of the sound. They also have an enormous impact on the rhythm and feel of a sequence. Once you have a rhythm you are happy with, go to the next step.

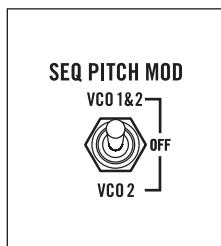

### SEQUENCING PITCH

It's time to start using the Sequencer to control the pitch of your bass note. Move the **SEQ PITCH MOD** switch to the **VCO 1&2** position. You should now be hearing subtle variations in pitch for each step of the sequence.

### PITCH VARIATION

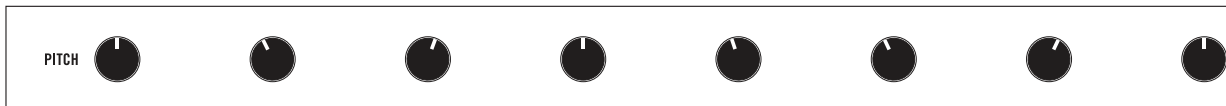

Make very small adjustments to all 8 of the Sequencer **PITCH** knobs and listen to how they affect the sound. These knobs have an extremely wide range, which will become very handy as you experiment with your DFAM over time.

**TIP:** If the notes your DFAM is playing have too much punch, try gently turning the **VCO 1 EG AMOUNT** knob toward the center until you like what you hear.

## EXPLORING THE DFAM *(Continued)*

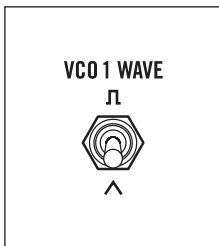

### CHANGING THE WAVEFORMS

Let's change up the sound. Set the **VCO 1 WAVE** switch to the **SQUARE** wave position and listen to how it affects the sound.

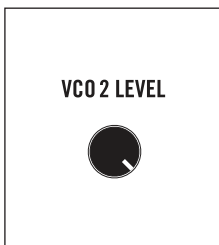

### ADDING AN OSCILLATOR

Turn the **VCO 2 LEVEL** knob all the way up.

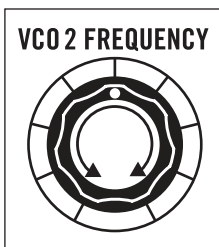

### CREATING HARMONY

Turn the **VCO 2 FREQUENCY** knob to the right until it sounds in tune with **VCO 1 FREQUENCY**.

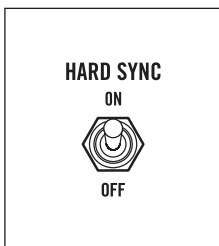

### HARD SYNC

Set the **HARD SYNC** switch to **ON**.

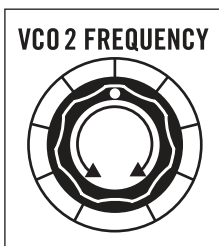

### LISTENING TO HARD SYNC

Now grab the **VCO 2 FREQUENCY** knob and turn it all the way up and down a few times. Notice that the pitch of Oscillator 2 stays directly related to the pitch of Oscillator 1 when **HARD SYNC** is **ON**.

**NOTE:** Because of the way that **HARD SYNC** works when it is **ON**, if the Frequency of Oscillator 2 goes below the Frequency of Oscillator 1, little to no sound will be output.

### PICK A SOUND

Set the **VCO 2 FREQUENCY** knob to a place that makes a sound you like and then go to the next step.

## EXPLORING THE DFAM *(Continued)*

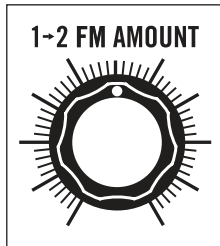

### EXPLORING FM

Gently turn the **1-2 FM AMOUNT** knob to 12 O'clock and listen to how the sound is changing. You are now shaking or "modulating" the pitch of Oscillator 2 with Oscillator 1.

Take a moment to experiment with how the **1-2 FM AMOUNT** knob and the **VCO 2 FREQUENCY** knob interact with each other. Feel free to adjust these controls individually or at the same time. A lot of sounds can be created from here.

**NOTE:** *FM is much more noticeable when **HARD SYNC** is set to **OFF**.*

When you find a sound you really like, leave it where it is and we'll shape it further.

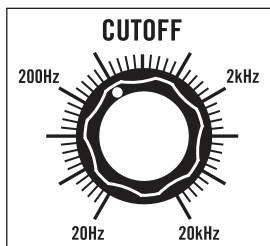

### FILTERING SOUND

Set the Filter **CUTOFF** knob to 11 O'clock. Notice that the sound is now dark and flat.

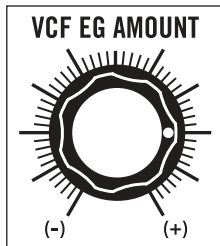

### FILTER MODULATION

Slowly increase the **VCF EG AMOUNT** knob to 3 O'clock. This is adding Envelope Modulation to the Filter Cutoff Frequency.

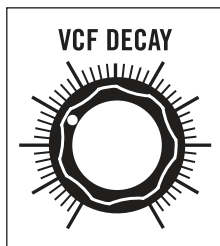

### FILTER ARTICULATION

The **VCF DECAY** knob will add a lot more motion to the timbre of this sound. Try turning it up slowly and listen to how it affects the articulation of each step in the sequence.

**TIP:** *Adding a little **RESONANCE** will lighten the low end and give the Filter more of a peak.*

When you're done experimenting, set the **VCF DECAY** knob to 10 O'clock.

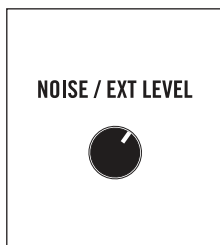

### NOISE AS A SOUND SOURCE

Turn the **NOISE / EXT LEVEL** knob to 1 O'clock. Adding a little noise as a sound source to a percussive sound will give it a more natural attack and can also create greater sonic depth.

## EXPLORING THE DFAM *(Continued)*

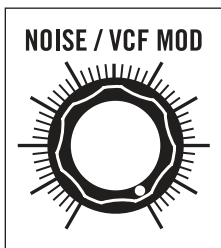

### NOISE AS A MODULATION SOURCE

Now slowly turn the **NOISE / VCF MOD** knob all the way up. Notice the difference when Noise is used as a Modulation Source for the Filter. Instead of creating depth, it makes the sound seem distorted or lo-fi.

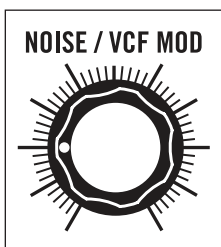

### SET THE NOISE MODULATION

Set the **NOISE / VCF MOD** knob to 9 O'clock.

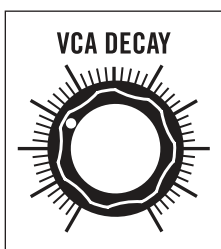

### SHORTENING VCA DECAY

Turn the **VCA DECAY** knob to 10 O'clock and listen to how the sound tightens up. This is because the natural Decay tails are being chopped off by the VCA, which is essentially a dynamic volume control.

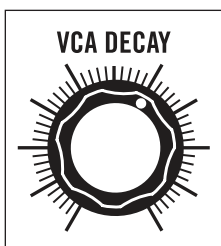

### EXTENDING THE VCA DECAY

Turn the **VCA DECAY** knob to 1 O'clock and listen to how the sound opens up. This is because the natural Decay tails are allowed to pass through.

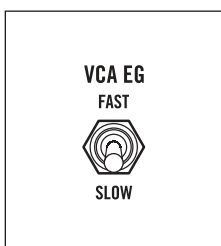

### SOFTENING THE ATTACK

Set the **VCA EG** switch to **SLOW** and turn the **VCA DECAY** knob between 9 and 10 O'clock. Listen to how it softens the attack of the sound.

**NOTE:** Shorter **VCA DECAY** settings will result in more dramatic results when the **VCA EG** switch is set to **SLOW**.

**This concludes our walkthrough.**

**REMEMBER:** Experimentation and learning will reward you with a lifetime of rich synthesizer experiences.

# PANEL CONTROLS & FUNCTIONS

## ■ VOLTAGE CONTROLLED OSCILLATORS (VCO)

In an analog synthesizer, oscillators are the primary source of sound. Your Drummer From Another Mother contains two Voltage Controlled Oscillators, also referred to as VCOs.

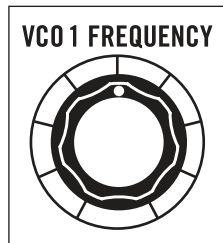

### VCO 1 FREQUENCY / VCO 2 FREQUENCY

The **VCO FREQUENCY** knobs specify the starting Pitch of each Oscillator over a ten-octave range. With no modulation applied, these Oscillators will track pitch accurately over multiple octaves, allowing your DFAM to be utilized for a wide range of musical applications beyond percussive sounds alone.

From the panel, the Pitch of Oscillator 1 and Oscillator 2 can be modified in 3 ways:

1. With the **VCO FREQUENCY** knobs
2. With the Sequencer **PITCH 1-8** knobs (See page 22)
3. With the **VCO EG AMOUNT** knobs (See page 16)

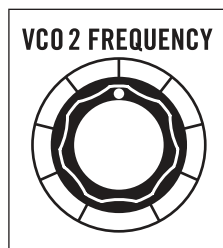

**TIP:** We recommend starting with both **VCO FREQUENCY** knobs at their center position. This setting is the equal to the center position of the Sequencer **PITCH 1-8** knobs.

**WARNING:** Because there are multiple ways to effect the Pitch of the Oscillators, it is possible for them to extend beyond the range of human hearing. If your DFAM stops making sound, this may be the case. Start by checking the patchbay as a wrong patch is the most common cause of muted sound. Then, return both **VCO FREQUENCY** knobs to their center position. If this does not resolve the issue, set both **VCO EG AMOUNT** knobs to their center position. If this has not resolved the issue, set the **SEQ PITCH MOD** switch to **OFF**. If this still does not resolve the issue, we recommend going back to the Default settings found on page 8.

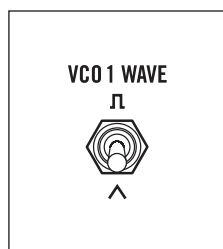

### VCO 1 WAVE / VCO 2 WAVE

Each Oscillator contains two selectable Waveforms, each with a distinctly different sound or timbre. The **VCO WAVE** switch is used to select between the two.

#### TRIANGLE

The Triangle wave is a very smooth and “warm” sounding waveform consisting of odd-numbered harmonics only. Its fundamental is very strong, and its overtones are very weak, making it less harmonically complex than other waveforms. The Triangle wave is useful for crafting organic percussion sounds like toms or marimbas, and also for recreating classic analog drum sounds.

**TIP:** Adding little bit of Noise as a sound source via the **NOISE / EXT LEVEL** knob in the Mixer is a great way to mimic classic ‘80s percussion sounds.



#### SQUARE

The Square wave provides more harmonic content and a much fuller or more aggressive sound than the Triangle wave. Its basic timbre is rich, but somewhat hollow due to the lack of even-numbered harmonics. The Square wave is useful for creating deep, hard-hitting bass sounds and for adding metallic characteristics to higher pitched FM sounds.

**TIP:** Use the Filter **CUTOFF** knob to shape Square wave sounds and to create more impactful percussive timbres.

## OSCILLATOR INTERACTION

DFAM's Oscillators can interact with each other to provide new timbres and to create new sounds.

**HARD SYNC** and **FM** are both useful tools that can be utilized individually or at the same time.

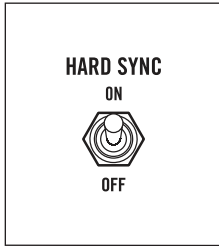

### HARD SYNC

When set to **ON**, **HARD SYNC** forces the phase of Oscillator 2 to match — or to be in sync with — the phase of Oscillator 1. This forced synchronization causes the waveform of Oscillator 2 to take on a more complex waveshape as it works to stay aligned with Oscillator 1. This is useful for creating sharp, metallic, and flange-like sounds while also ensuring that the pitch of Oscillator 2 stays locked to Oscillator 1.

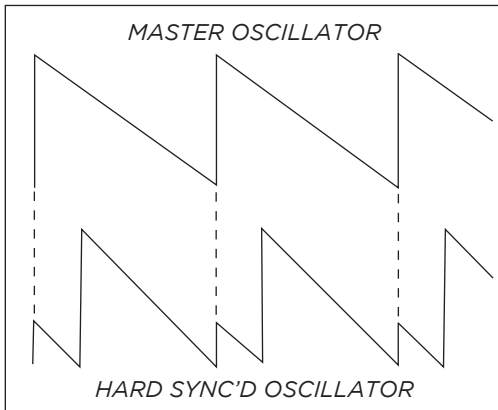

**TIP:** With the **HARD SYNC** switch set to **ON**, turn the **VCO 2 FREQUENCY** knob and listen. Notice that it has an effect on the timbre of Oscillator 2, while maintaining a synchronized pitch with Oscillator 1.

**NOTE:** When the **HARD SYNC** switch is set to **ON** and the Frequency of Oscillator 2 is set below the Frequency of Oscillator 1, Oscillator 2 may be unable to complete a wave cycle before resetting to match the phase of Oscillator 1. In this case, Oscillator 2 may have little or no output. This is especially the case with Square waveforms.

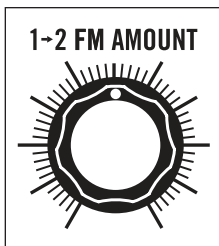

### 1->2 FM AMOUNT (FREQUENCY MODULATION)

A common application of modulation is pitch vibrato. This occurs when a Low Frequency Oscillator (LFO) is used to smoothly vary the pitch of an audio oscillator up and down. If the frequency of that LFO is increased enough, the pitch of the audio oscillator is being moved up and down just as before, but at an extremely fast rate. This creates new sidebands and other harmonics not present in either of the original signals.

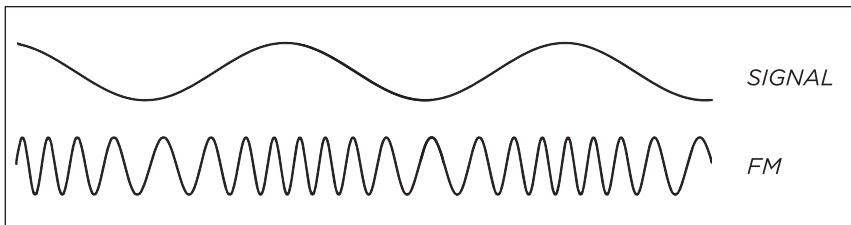

The sonic characteristics of FM are highly dependant on the pitch of both Oscillator 1 and Oscillator 2. Depending on the settings, the sound of FM can be described as complex, springy, bell-like, or aggressive.

Turning the **1->2 FM AMOUNT** knob to the right will gradually increase the amount by which the Frequency of Oscillator 2 is being modulated by Oscillator 1.

**TIP:** Slowly turn the **1->2 FM AMOUNT** knob to the right and listen to how it affects the sound. Now try adjusting the **VCO FREQUENCY** knobs and listen to how they interact with each other.

## OSCILLATOR MODULATION

Changes in Oscillator pitch can come from multiple sources, but two are immediately available without patching: the Sequencer **PITCH 1-8** knobs and the VCO Envelope Generator, which is itself directly affected by the Sequencer **VELOCITY 1-8** knobs.

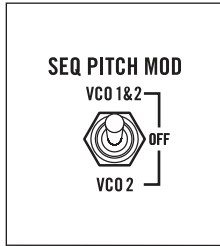

### SEQ PITCH MOD

This three-position switch determines which Oscillators are being controlled, or modulated, by the Sequencer **PITCH 1-8** knobs.

### VCO 1 & 2

The Sequencer **PITCH 1-8** knobs are assigned to the Frequency of Oscillator 1 and Oscillator 2. This is useful for creating sequenced bass and lead lines where Oscillator 1 and Oscillator 2 are tuned in unison.

### OFF

The Sequencer **PITCH 1-8** knobs are not assigned to either Oscillator, but can still be used in conjunction with the **PITCH CV** output in the Patchbay. This selection is useful for creating droning and non-pitched percussion sounds like high-hats.

**TIP:** With the **SEQ PITCH MOD** switch set to **OFF**, try patching the **PITCH CV** output to different CV inputs and experiment with using the Sequencer **PITCH 1-8** knobs as a sequenced modulation source. (See preset *Quick Hats* on page 33.)

### VCO 2

The Sequencer **PITCH 1-8** knobs are assigned to the Frequency of Oscillator 2 only. This is useful when used with **FM** or **HARD SYNC** for adding synchronized motion to a static percussion sound.

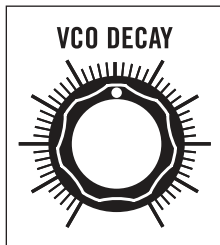

### VCO DECAY

Your DFAM is equipped with an Envelope Generator (EG) dedicated to modulating the Pitch of its Oscillators. The Decay Time of this EG is set using the **VCO DECAY** knob.

**IMPORTANT NOTE:** If the **VCO EG AMOUNT** knobs are at center position, no Pitch Modulation will occur and the **VCO DECAY** knob will appear to have no function. This setting can be quite useful for creating sequenced bass lines.

### 7 O'CLOCK (MINIMUM)

The Decay is almost immediate and its effect on the Pitch of the Oscillators is extremely snappy. This is good for adding a sharp impact to the initial attack of a sound.

### 9 - 10 O'CLOCK

This setting is useful for creating the punch that occurs when a drum head is hit with a drum stick or beater. As this knob approaches the 10 O'clock mark, it will introduce more of an exaggerated or rubbery sound to the attack of a note.

### 12 O'CLOCK AND BEYOND

These settings are useful when paired with slower sequences for creating exaggerated "booms" or spacey sounds that decay slowly over time.

**NOTE:** The Sequencer **VELOCITY 1-8** knobs are connected to the Velocity input of the Envelope Generators, providing dynamic variations to both the Amplitude and Decay Time of the VCO Envelope Generator.

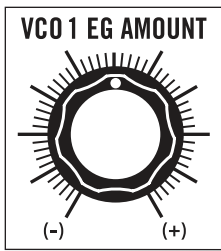

### VCO 1 EG AMOUNT / VCO 2 EG AMOUNT

This pair of knobs determines how much effect the VCO Envelope Generator will have on the Pitch of Oscillator 1 and Oscillator 2, respectively. All **AMOUNT** knobs on DFAM are bipolar, meaning that they have both positive (+) and negative (-) modulation values available.

#### CENTER POSITION

No Envelope is applied to the Pitch of the Oscillator and its Frequency remains steady.

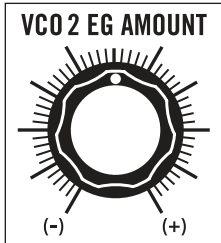

#### (+) AMOUNT

As the **VCO EG AMOUNT** knob is rotated to the right of center, more Envelope Modulation is applied to the Pitch of the Oscillator. This results in larger jumps or spikes in pitch as each note is played, creating sounds that may be perceived as harder hitting, more aggressive or exaggerated.

**NOTE:** The **VCO DECAY** knob will determine how quickly the jump, or spike in pitch falls back to its original note.

#### (-) AMOUNT

As the **VCO EG AMOUNT** knob is rotated to the left of center, negative Envelope Modulation is applied to the Pitch of the Oscillator. This results in dips or large drops in pitch as each note is played, creating sounds that may be perceived as boingy or somewhat videogame-esque in character.

**NOTE:** The **VCO DECAY** knob will determine how quickly the drop, or dip, in pitch rises back to its original note.

**TIP:** Using lower **VCO EG AMOUNT** values will result in more natural percussion sounds, while larger values will result in more exaggerated and extreme sounds.

## ■ MIXER

In addition to Level knobs for VCO 1 and VCO 2, your Drummer From Another Mother's Mixer also includes a Level knob for its built-in White Noise Generator, which is useful for creating snare drums and high-hats, and also for adding depth and attack to pitched percussion sounds.

**NOTE:** Your DFAM is an all-analog instrument. Varying levels in the Mixer section will have an effect on the overall sound. Lower levels will result in increased headroom and dynamics, while higher levels will produce a more aggressive and clipped sound.

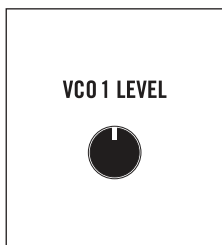

### VCO 1 LEVEL

Use this knob to set the level of Oscillator 1.

**NOTE:** The Square Wave will be perceived as louder than the Triangle Wave. This is due to differences in harmonic content and is completely normal.



## MIXER (Continued)

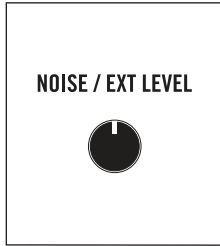

### NOISE / EXT LEVEL

This knob is used to set the level of the White Noise Generator. Its value can also be controlled via the **NOISE LEVEL** CV input (VCA) on the Patchbay.

An External Audio signal can be used in place of the White Noise Generator by connecting it to the **EXT AUDIO** input jack on the DFAM Patchbay. The level of the External Audio signal would then be attenuated using this knob.

**NOTE:** The **EXT AUDIO** input jack is a 3.5mm TS input and will not work with a standard 1/8" TRS headphone-style cable. Because this is a unity gain input designed for Eurorack signal levels, an external audio source applied to this input should be 10V peak to peak. Signals lower than this (an MP3 player for instance) will need to be amplified prior to being input to the **EXT AUDIO** jack for proper volume performance levels.

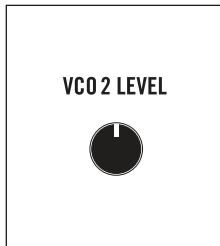

### VCO 2 LEVEL

Use this knob to set the level of Oscillator 2.

**NOTE:** The Square Wave will be perceived as louder than the Triangle Wave. This is due to differences in harmonic content and is completely normal.

## ■ VOLTAGE CONTROLLED FILTER (VCF)

Your Drummer From Another Mother features a Voltage Controlled Ladder Filter that can be used in either Low Pass or High Pass mode. The purpose of this Filter is to dynamically shape the timbre of a sound by selectively removing harmonic content above or below the Filter's manually selected Cutoff Frequency.

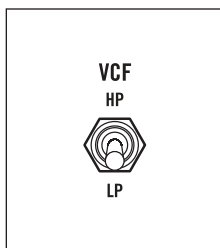

### VCF

This switch is used to determine whether the Filter is in Low Pass or High Pass mode.

#### LP (LOW PASS)

In this mode, harmonic content above the Filter's Cutoff Frequency is attenuated, allowing only lower frequencies to pass. This mode is ideal for sculpting thick, dark, or natural sounds.

#### HP (HIGH PASS)

In this mode, harmonic content below the Filter's Cutoff Frequency is attenuated, allowing only higher frequencies to pass. This mode is ideal for crafting bright, thin, or snappier sounds.

## VOLTAGE CONTROLLED FILTER (VCF) (Continued)

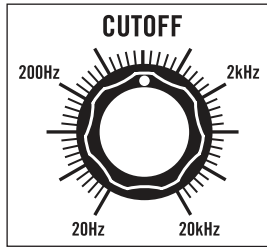

### CUTOFF

The **CUTOFF** knob specifies the Frequency at which the Filter begins to attenuate (or reduce) sound in either the Low Pass or High Pass mode.

**NOTE:** The 4-pole Ladder Filter provides 24dB of attenuation per octave beginning at the Filter's Cutoff point.

### LOW PASS MODE

As the Filter **CUTOFF** knob is turned to the right, the top end of the Filter will open, resulting in a brighter and more articulate sound, while retaining lower frequency harmonics. As the Filter **CUTOFF** knob is turned to the left, the Filter will close, resulting in a thicker or dark sound.

### HIGH PASS MODE

As the Filter **CUTOFF** knob is turned to the right, low frequency harmonics are removed, creating a bright and more cutting sound. As the Filter **CUTOFF** knob is turned to the left, low frequency information is allowed to pass while retaining a bright upper spectrum of sound.

**WARNING:** The Filter **CUTOFF** knob can be set manually from 20Hz to 20kHz — roughly the same range as human hearing. Certain Filter and Modulation settings can cause DFAM to seem as if it is not making sound. If you think this is the case, set the Filter **CUTOFF** knob and the **VCF EG AMOUNT** knob to center position. If this does not resolve the issue, try setting the **VCF** switch to **LP**. If this still does not resolve the issue, we recommend going back to the Default settings found on page 8.

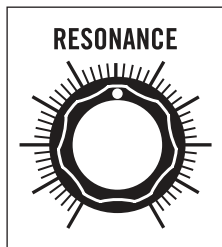

### RESONANCE

The **RESONANCE** knob determines how much signal is routed from the Filter's output back to its input. As the **RESONANCE** knob is turned to the right, a peak or harmonic boost at the Filter's Cutoff frequency is created and bass frequencies may be attenuated.

**TIP:** Resonance settings above 3 O'clock in **LOW PASS** mode will cause the Filter to self oscillate, creating a Sine Wave that can be used as an additional sound source. (See preset Filter As An Oscillator on page 35.)

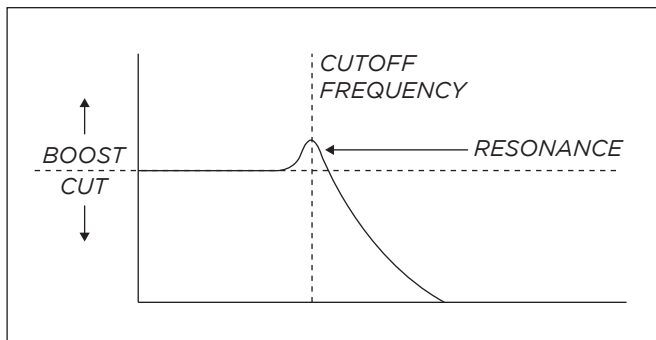

**NOTE:** In **HIGH PASS** mode, the **RESONANCE** knob does not have the same scaling as in **LOW PASS** mode. With the **RESONANCE** knob set to its maximum position, self-oscillation begins with the Filter **CUTOFF** knob set to approximately 1kHz. This is normal.

## VOLTAGE CONTROLLED FILTER (VCF) *(Continued)*

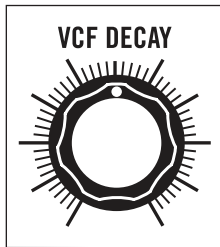

### VCF DECAY

The VCF Envelope Generator is dedicated to modulating the Cutoff Frequency of the Filter. The Decay time of this EG is set using the **VCF DECAY** knob. This value may also be affected by the Sequencer **VELOCITY 1-8** knobs. These Velocity levels are connected to the Velocity inputs of the Envelope Generators, providing an additional source of voltage control to both the Amplitude and Decay Time of the **VCF EG**.

**IMPORTANT NOTE:** If the **VCF EG AMOUNT** knob is at center position, no Filter modulation will occur, and the **VCF DECAY** knob will appear to have no function.

### 7 O'CLOCK (MINIMUM)

The Decay is almost immediate and its effect on the Filter is minimal. This is good for adding a gentle tap, click, or pop to the beginning of a sound.

### 10 O'CLOCK

This setting is useful for creating a sharp slap or crack to the initial attack of a sound.

### 12 O'CLOCK

This setting creates a more natural sweep of the Filter and is useful for allowing the decay of kick drums, toms, and other sounds to ring through naturally.

### PAST 12 O'CLOCK

These settings cause the Filter to remain open for an extended period of time and are ideal for crafting aggressive or long-tailed sounds.

**TIP:** Turning the **RESONANCE** knob to the right will exaggerate any modulation of the Filter's Cutoff Frequency. This is useful for adding more motion or "squawk" to a sound.

**NOTE:** VCF Decay times range from 10ms to 10 seconds. How much of that effect can be heard is dependant on the **VCF EG AMOUNT** settings.

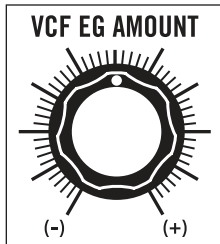

### VCF EG AMOUNT

This knob determines how much effect the VCF Envelope Generator will have on the Cutoff Frequency of the Filter. All **AMOUNT** knobs on DFAM are bipolar, meaning that they have both positive (+) and negative (-) values available.

### CENTER POSITION

No Envelope is applied to the Filter's Cutoff Frequency.

### (+) AMOUNT

As the **VCF EG AMOUNT** knob is rotated to the right of center, more Envelope Modulation is applied to the Filter's Cutoff Frequency. This causes the Filter Cutoff Frequency to be increased, regardless of the VCF switch setting.

Positive **VCF EG AMOUNT** settings result in larger jumps or spikes in timbre as each note is played, creating sounds that may be perceived as more articulate, dynamic, or aggressive.

**NOTE:** The **VCF DECAY** knob determines how quickly the change in timbre returns to its original value over time.

## VCF EG AMOUNT (Continued)

### (-) AMOUNT

As the **VCF EG AMOUNT** knob is rotated to the left of center, negative Envelope Modulation is applied to the Filter's Cutoff Frequency. This causes the Filter Cutoff Frequency to be decreased, regardless of the VCF switch setting.

Negative **VCF EG AMOUNT** settings result in dips or large drops in Filter Frequency as each note is played, creating sounds that may be perceived as blooming, boingy, or somewhat videogame-esque in character.

**NOTE:** The **VCF DECAY** knob determines how quickly the change in timbre returns to its original value over time.

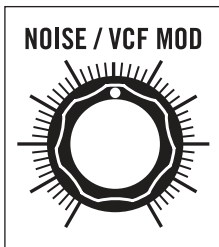

### NOISE / VCF MOD

The Filter's Cutoff Frequency can be Modulated using the onboard Noise Generator, resulting in dirty, distorted, or lo-fi sounds. It is also useful for adding sizzle to cymbal sounds. Turning the **NOISE / VCF MOD** knob to the right determines how much the Filter's Cutoff Frequency is being modulated (or shaken) by the Noise Generator.

By patching into the **VCF MOD** input jack on the Patchbay, any control signal can modulate the Filter's Cutoff Frequency. Utilizing this patchpoint will override Noise as the Modulation Source and will cause the **NOISE / VCF MOD** knob to now determine how much the Filter's Cutoff Frequency is being modulated by the new signal that has been patched into the **VCF MOD** input jack.

**TIP:** Try patching out of **VCO 2** into the **VCF MOD** input. With the **NOISE / VCF MOD** knob set at maximum, listen to how the Pitch of Oscillator 2 affects the sound of the Filter. (See preset *FM Toys* on page 34.)

## ■ VOLTAGE CONTROLLED AMPLIFIER (VCA)

The VCA controls the volume of your DFAM. Its output level is determined by the VCA Envelope Generator and by the values set per step on the Sequencer **VELOCITY 1-8** knobs. In addition to Decay Time, the VCA Envelope Generator also offers two selectable speeds for its Attack Time.

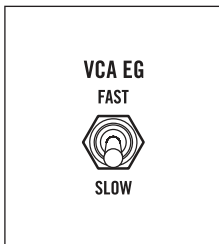

### VCA EG

This switch is used to determine the Attack Time of the **VCA EG**.

#### FAST

In this position, the Attack Time of the VCA EG is set to 1ms. This setting is ideal for creating quick and articulate sounds with immediate snap and punch such as high-hats and kick drums.

**NOTE:** 1ms is the same Attack Time utilized by the VCO and VCF Envelope Generators.

#### SLOW

In this position, the Attack Time of the VCA EG is set to 100ms. This setting is effective for crafting sounds with softer attacks such as soft mallets, brushed snares, or gong sounds.

**TIP:** When used with sequenced bass sounds, the **SLOW VCA** setting can subtly emulate the effect of *Glide*. (See preset *Sequenced Bass* on page 34.)

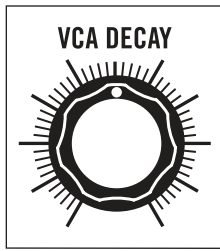

## VCA DECAY

The third and final Envelope Generator in your DFAM is dedicated to modulating the Output volume of the VCA. The Decay time of this EG is set using the **VCA DECAY** knob. This value may also be affected by the Sequencer **VELOCITY 1-8** knobs. These Velocity levels are connected to the Velocity inputs of the Envelope Generators, providing an additional source of voltage control to the Amplitude and Decay time of the **VCA EG**.

### 7 O'CLOCK (MINIMUM)

The Decay is nearly immediate and will result in little sound being output. This setting is ideal for crafting short sounds with sharp attacks, such as tight hi-hats.

### 9 O'CLOCK

Sound is now audible for a brief moment. This setting is useful for creating short blips, hits, and claps where a small portion of the body of a sound is desirable.

### 10 O'CLOCK

This setting allows a greater amount of sound to pass over time while still remaining percussive and tight. It is ideal for short, but hard-hitting thumps and tuned percussion sounds.

### 11 O'CLOCK

Sounds are now able to ring out and resonate. The decaying "note" of a pitched percussion sound is now much easier to hear, while the punch of the sound is still prominent. This setting is useful at faster tempo settings.

### 12 O'CLOCK

Sounds are now able to ring out over a long period of time and the more musical resonances of DFAM can be heard. This setting is particularly useful when creating percussion sounds that share both low and high frequency information.

### PAST 12 O'CLOCK

Sounds begin to wash together in an almost drone-like manner, while retaining their individuality. Settings above 12 O'Clock are useful for creating deep, musical experiences where note articulation and dynamics are crafted in the Filter.

**TIP:** Patch the **PITCH CV** output into the **VCA DECAY** input and use the Sequencer **PITCH 1-8** knobs to vary the feel of a sound. (See preset *Quick Hats* on page 33.)

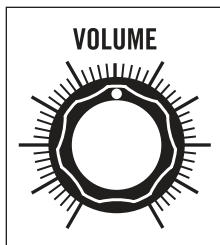

## VOLUME

Use the **VOLUME** knob to set a comfortable headphone listening level, or to adjust the final output level of your DFAM.

## ■ ANALOG 8-STEP SEQUENCER

Your Drummer From Another Mother includes an all-analog 8-Step Sequencer with two rows of knobs. One is for **PITCH**; the other is for **VELOCITY**. Together, they provide the tools for crafting dynamic and expressive rhythmic percussion patterns.

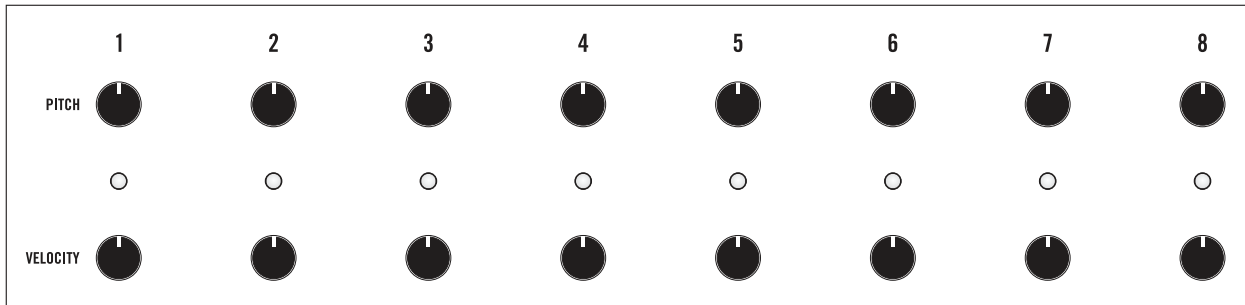

### STEP CONTROLS

Each Sequencer step (1–8) features a **PITCH** knob, a **VELOCITY** knob, and an LED that indicates the currently active step.

**NOTE:** In order for the Sequencer to effect the Pitch of the Oscillators in your DFAM, the **SEQ PITCH MOD** switch must be set to **VCO 1&2** or **VCO 2**.

### PITCH

**PITCH** knob values set to the right of center will add to the value of the **VCO FREQUENCY** knob, raising the Pitch for that step only. Values to the left of the center position will subtract from the **VCO FREQUENCY** knob, lowering the Pitch for that step.

**NOTE:** The Sequencer **PITCH 1-8** knobs have roughly a 10-octave range ( $\pm 5$  Volts). This voltage is also available at the **PITCH CV** output on your DFAM patchbay.

### VELOCITY

The values specified by the Sequencer **VELOCITY 1-8** knobs determine the Velocity level of each step as it played. The Velocity value is connected to the Velocity input and sets the Amplitude of all three Envelope Generators: the **VCO EG**, the **VCF EG**, and the **VCA EG**. Low Velocity settings will create quieter and less impactful sounds, while higher Velocity settings will create much louder and hard-hitting sounds. If the **VELOCITY 1-8** knobs are turned to their minimum position, DFAM will not output sound.

**TIP:** Try varying Velocity values between steps on any sequence for a more lifelike behavior. Sequencer steps with higher Velocity values may cause the Envelope Generators to have slightly longer Decay times. Lower Velocity values may not be audible.

**NOTE:** The full range of each Velocity knob is 0 Volts to 5 Volts. This voltage is also available at the **VELOCITY** output on your DFAM patchbay.

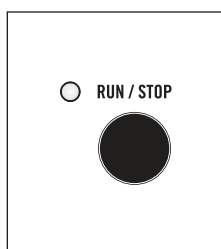

### RUN / STOP

Pressing the **RUN / STOP** button will cause the Sequencer to begin playing from the current step (indicated by a Red LED), and at the current Tempo. If the Sequencer is already running, pressing the **RUN / STOP** button will halt playback of the Sequencer.

**NOTE:** The red LED adjacent to the **RUN/STOP** button indicates whether the Sequencer is running (lit) or stopped (unlit).

## ANALOG 8-STEP SEQUENCER (Continued)

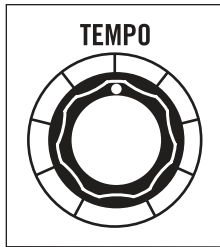

### TEMPO

The **TEMPO** knob sets the Sequencer playback speed, which is continuously variable from .7Hz to 700Hz. Assuming each step represents a 16th note, the Tempo can be set from roughly 10 BPM to about 10,000 BPM.

**TIP:** Try patching from the **PITCH CV** or **VELOCITY CV** output, into the **TEMPO CV** input. The Sequencer **PITCH 1-8** or Sequencer **VELOCITY 1-8** knobs will now determine the length of each step in the sequence. Be patient, this one can be tricky! (See preset *Swing Time* on page 36.)

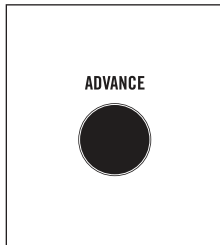

### ADVANCE

With Sequencer playback stopped, pressing the **ADVANCE** button will manually cycle to the next step of the Sequence without triggering each note it passes.

**NOTE:** An external clock source can be connected to the **ADV/CLOCK** input on the DFAM patchbay. This input can also be used to advance the Sequencer to the next step, allowing for different timings and rhythmic patterns to be created using an external clock source like the *Mother-32*.

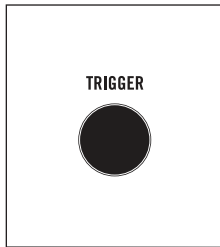

### TRIGGER

With Sequencer playback stopped, pressing the **TRIGGER** button will Trigger the current Sequencer Step (indicated by the LED) without advancing to the next step. This makes it simple to fine-tune settings for a specific step by playing it as many times as needed while adjustments are made.

## ■ PATCHBAY

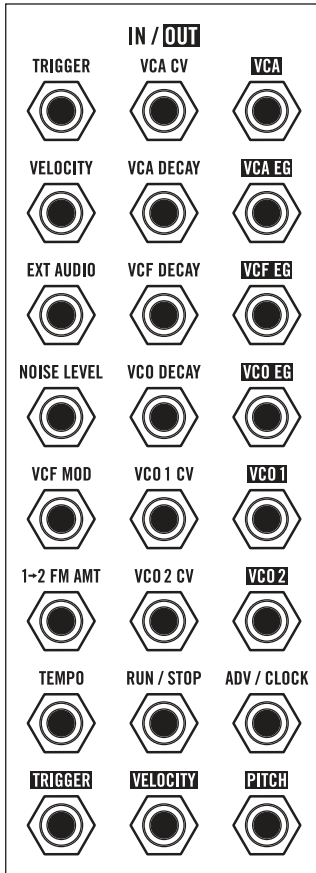

### PATCHBAY

The DFAM Patchbay is equipped with 24 x 3.5mm patch points, which allow for extended synthesis capabilities and modular interconnectivity. There are 15 inputs **LABELLED** in standard text, and 9 outputs identified by **REVERSE** lettering.

The Patchbay is designed to work with 3.5mm patch cables only. A pack of five is included with your DFAM. If you should need more, 6" and 12" packs of Moog cables are available for purchase at authorized Moog dealers.

**NOTE:** When patching, it is OK to split an output signal with a "Mult", a TS to dual TS "Y" cable, or by using cables with stackable plugs. Connect only one output signal to a CV input to prevent over-voltages.

### AVAILABLE INPUTS

TRIGGER, VCA CV, VELOCITY, VCA DECAY, EXT AUDIO, VCF DECAY, NOISE LEVEL, VCO DECAY, VCF MOD, VCO 1 CV, 1→2 FM AMT, VCO 2 CV, TEMPO, RUN / STOP, ADV / CLOCK.

### AVAILABLE OUTPUTS

VCA, VCA EG, VCF EG, VCO EG, VCO 1, VCO 2, TRIGGER, VELOCITY, PITCH.

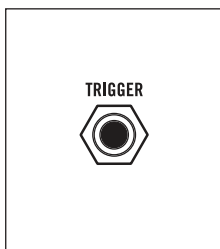

### TRIGGER (TRIGGER INPUT)

This input will Trigger all three DFAM Envelope Generators at the currently selected Sequencer Step Velocity level without causing DFAM to advance to the next step in a sequence. This is useful when connecting to external sequencers.

#### INPUT

0 to +5V Pulse or Gate signal (+10V tolerant)

**NOTE:** The **TRIGGER** input is normalled (or hard-wired) to the Sequencer Clock Signal and then routed to the Envelopes and the **TRIGGER** output.

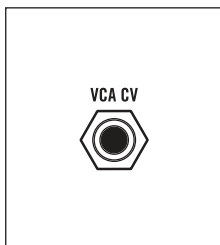

### VCA CV (VCA CONTROL VOLTAGE INPUT)

This input allows a control voltage to be applied to DFAM's output VCA, providing another means of varying or modulating the overall volume or timbre of the sound.

#### INPUT

0 to +8V Control Voltage

**NOTE:** This input is summed with the internal **VCA EG** control signal, which may cause certain patches to "clip" the VCA. This may or may not be desirable.



## PATCHBAY *(Continued)*

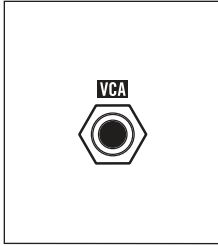

### VCA (AUDIO OUTPUT)

This is the main audio output of the internal VCA set by the **VOLUME** knob.

#### OUTPUT

-5V to +5V Audio Signal at typical Eurorack levels

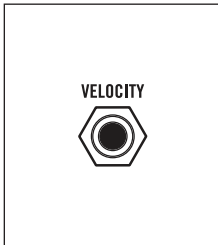

### VELOCITY (VELOCITY CONTROL VOLTAGE INPUT)

This input controls the maximum amplitude of DFAM's Envelope Generators, and is one of the keys to DFAM's highly dynamic and expressive sound.

#### INPUT

0V to +5V Control Voltage

**NOTE:** The **VELOCITY** input is normalised (or hard-wired) to the Sequencer **VELOCITY 1-8** knobs.

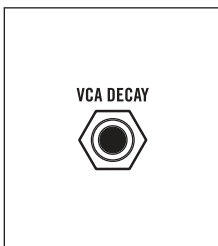

### VCA DECAY (VCA DECAY CONTROL VOLTAGE INPUT)

This input determines the Decay Time of the VCA EG and is useful for adding variations to non-pitched percussion patterns such as hi-hats.

#### INPUT

-5V to +5V Control Voltage

**NOTE:** The **VCA DECAY** input is summed with the manual **VCA DECAY** knob. Setting the **VCA DECAY** knob to its middle position will offer the widest range of values from an external CV signal.

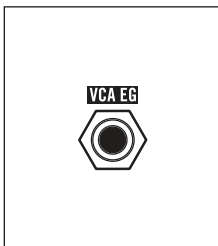

### VCA EG (VCA EG CONTROL VOLTAGE OUTPUT)

This output provides a copy of the control voltage used to modulate the VCA internally.

#### OUTPUT

0V to +8V Control Voltage

**NOTE:** The **VCA EG** output voltage is based on the Sequencer **VELOCITY 1-8** knobs, the **VCA DECAY** knob, and the **VCA EG SLOW / FAST** switch.

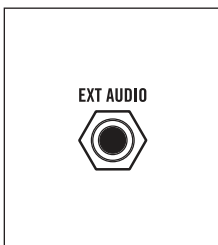

### EXT AUDIO (EXTERNAL AUDIO INPUT)

Plugging an External Audio source into this jack removes the Noise Generator from the signal path and replaces it with the External Audio Signal. The volume of this signal is then controlled by the **NOISE / EXT LEVEL** knob in the DFAM Mixer.

#### INPUT

10V peak to peak audio signal

**NOTE:** Because this is a unity gain input designed for typical Eurorack signal levels, an external audio source applied to this input should be 10V peak to peak. Signals lower than this (an MP3 player for instance) will need to be amplified prior to being input to the **EXT AUDIO** jack for proper volume performance levels.

## PATCHBAY OVERVIEW *(Continued)*

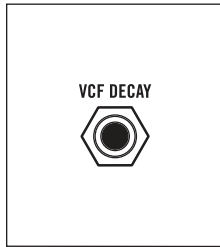

### **VCF DECAY (VCF DECAY CONTROL VOLTAGE INPUT)**

This input determines the Decay Time of the **VCF EG** and is useful for creating large variations in timbre for more complex sounds.

#### **INPUT**

-5V to +5V Control Voltage

**NOTE:** The **VCF DECAY** input is summed with the manual **VCF DECAY** knob. Setting the **VCF DECAY** knob to its middle position will offer the widest range of values from an external CV signal.

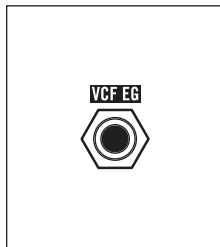

### **VCF EG (VCF EG CONTROL VOLTAGE OUTPUT)**

This output provides a copy of the control voltage used to modulate the VCF internally.

#### **OUTPUT**

0V to +8V Control Voltage

**NOTE:** The **VCF EG** output voltage is informed by the Sequencer **VELOCITY 1-8** knobs and the **VCF DECAY** knob.

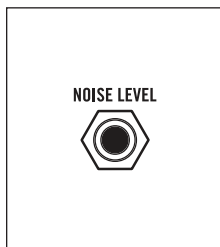

### **NOISE LEVEL (NOISE LEVEL CONTROL VOLTAGE INPUT)**

This input modulates the value of the **NOISE / EXT LEVEL** knob in the Mixer section regardless of whether it is controlling the Noise level, or the level of an External Audio Signal connected via the **EXT AUDIO** input jack.

#### **INPUT**

0 to +8V Control Voltage

**NOTE:** A voltage applied to the **NOISE LEVEL** input is added to the position of the manual **NOISE / EXT LEVEL** knob in the mixer section. It is possible to clip the Noise Level VCA which may or may not be desirable.

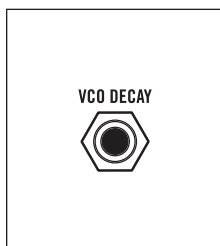

### **VCO DECAY (VCO DECAY CONTROL VOLTAGE INPUT)**

This input determines the Decay Time of the **VCO EG** and is useful for adding pitched dynamics to various tuned percussion sounds.

#### **INPUT**

-5V to +5V Control Voltage

**NOTE:** The **VCO DECAY** input is summed with the manual **VCO DECAY** knob. Setting the **VCO DECAY** knob to its middle position will offer the widest range of values from an external CV signal.

## PATCHBAY OVERVIEW *(Continued)*

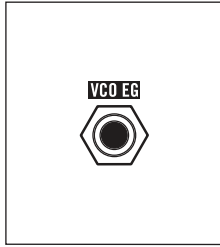

### **VCO EG (VCO EG CONTROL VOLTAGE OUTPUT)**

This output provides a copy of the control voltage used to modulate the VCOs internally.

#### **OUTPUT**

0V to +8V Control Voltage

**NOTE:** The **VCO EG** output voltage is informed by the Sequencer **VELOCITY 1-8** knobs and the **VCO DECAY** knob.

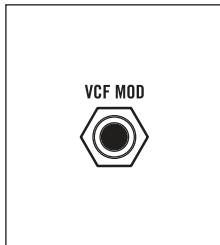

### **VCF MOD (VCF MODULATION CONTROL VOLTAGE INPUT)**

Plugging a control voltage into this jack replaces the Noise Generator as a hard-wired modulation source for the VCF. The maximum amount of modulation applied to the Filter will still be controlled by the **NOISE / VCF MOD** knob.

#### **INPUT**

-5V to +5V Control Voltage

**NOTE:** The **VCF MOD** input is the only means of directly applying a control voltage to the Filter's Cutoff Frequency. For complete CV control over the Filter, ensure that the **NOISE / VCF MOD** knob is set to its maximum position.

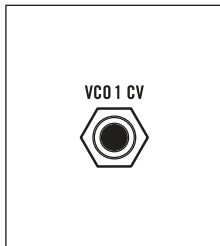

### **VCO 1 CV (VCO 1 CONTROL VOLTAGE INPUT)**

This input provides 1V/Octave control over the Pitch of Oscillator 1. It is summed with the **VCO 1 FREQUENCY** knob, the **VCO 1 EG AMOUNT** knob, and the individual Sequencer **PITCH 1-8** knobs (if the **SEQ PITCH MOD** switch is set to **VCO 1&2**).

#### **INPUT**

-5V to +5V Control Voltage

**NOTE:** For accurate 1V/Octave control over the Pitch of Oscillator 1, set the **VCO 1 FREQUENCY** and **VCO 1 EG AMOUNT** knobs to their middle positions, and ensure that the **SEQ PITCH MOD** switch is set to **OFF** or **VCO 2**.

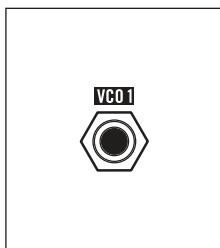

### **VCO 1 (VCO 1 SIGNAL OUTPUT)**

This is the direct output of Oscillator 1. It can be used as a sound source or as a modulation source.

#### **OUTPUT**

-5V to + 5V (10V peak to peak)

**NOTE:** The **VCO 1** output is affected by the **VCO 1 FREQUENCY** knob, the **VCO 1 WAVE** switch, the **VCO 1 EG AMOUNT** knob, and the individual Sequencer **PITCH 1-8** knobs (if the **SEQ PITCH MOD** switch is set to **VCO 1&2**).

## PATCHBAY OVERVIEW *(Continued)*

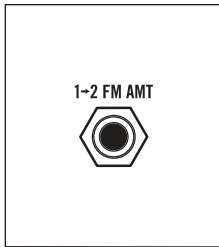

### **1→2 FM AMT (VCO 1 TO VCO 2 FREQUENCY MODULATION AMOUNT INPUT)**

This input modulates the value of the **1→2 FM AMOUNT** knob to determine the amount of modulation (Linear FM ) applied to Oscillator 2 by Oscillator 1.

#### **INPUT**

0V to +8V Control Voltage

**NOTE:** A voltage applied to the **1→2 FM AMT** input is summed with the position of the manual **1→2 FM AMT** knob.

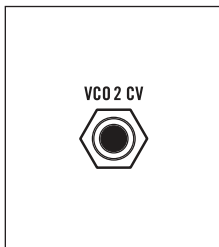

### **VCO 2 CV (VCO 2 CONTROL VOLTAGE INPUT)**

This input provides 1V/Octave control over the Pitch of Oscillator 2. It is summed with the **VCO 2 FREQUENCY** knob, the **VCO 2 EG AMOUNT** knob, and the individual Sequencer **PITCH 1-8** knobs (if the **SEQ PITCH MOD** switch is set to **VCO 1&2** or to **VCO 2**).

#### **INPUT**

-5V to +5V Control Voltage

**NOTE:** For accurate 1V/Octave control over the Pitch of Oscillator 2, set the **VCO 2 FREQUENCY** and **VCO 2 EG AMOUNT** knobs to their middle positions, and ensure that the **SEQ PITCH MOD** switch is set to **OFF**.

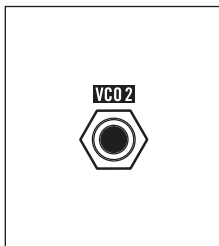

### **VCO 2 (VCO 2 SIGNAL OUTPUT)**

This is the direct output of Oscillator 2. It can be used as a sound source or as a modulation source.

#### **OUTPUT**

-5V to +5V (10V peak to peak)

**NOTE:** The **VCO 2** output is affected by the **VCO 2 FREQUENCY** knob, the **VCO 2 WAVE** switch, the **VCO 2 EG AMOUNT** knob, and the individual Sequencer **PITCH 1-8** knobs (if the **SEQ PITCH MOD** switch is set to **VCO 1&2** or to **VCO 2**).

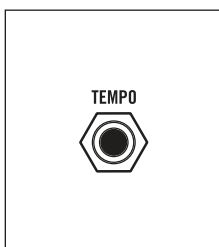

### **TEMPO (CLOCK VCO CONTROL VOLTAGE INPUT)**

This input provides 1V/Octave control over the Frequency of the Sequencer Clock VCO. This allows the Clock speed (Tempo) to be controlled by an external source all the way into audio rates.

#### **INPUT**

-5V to +5V Control Voltage

**NOTE:** A voltage applied to the **TEMPO** input is summed with the position of the **TEMPO** knob.

## PATCHBAY OVERVIEW *(Continued)*

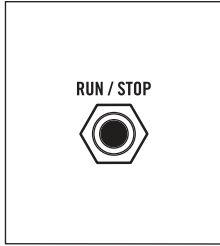

### **RUN / STOP (GATE INPUT)**

This input allows an external voltage to start and stop the DFAM Sequencer. When a +5V signal is applied to this input, the Sequencer will play from its current pattern location for the duration that the voltage is applied. When a 0V signal is applied to this input, the Sequencer will stop at its current pattern location.

#### **INPUT**

0V to +5V Gate (+10V tolerant)

**NOTE:** An external Clock Signal applied here will advance the steps of the pattern in the same way repeatedly pressing the **RUN/STOP** button does, but the Internal Clock is **NOT** synchronized.

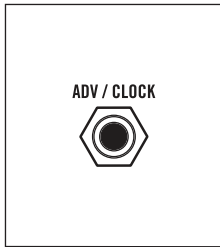

### **ADV / CLOCK (SEQUENCER STEP ADVANCE / CLOCK INPUT)**

This input allows the DFAM to be synchronized to an external clock source such as another DFAM or a Mother-32. When the input of a clock's rising edge is detected, the Sequencer pattern is advanced by one step. In this mode, the **TEMPO** knob is ignored.

#### **INPUT**

0V to +5V Clock Signal (+10V tolerant)

**NOTE:** Slowly changing signals may be ignored. An example of this would be an Accent assigned to the Assignable output jack on the Mother-32.

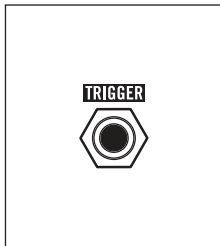

### **TRIGGER (TRIGGER OUTPUT)**

This output provides a pulse derived from the Sequencer Clock that can be used as a clock source for synchronizing to other instruments, or as a Trigger signal. Each time a new note is played via the sequencer, a +5V Trigger signal is output both to DFAMs Envelope Generators and to the **TRIGGER** output jack.

#### **OUTPUT**

0V to +5V pulse (roughly 1ms in width)

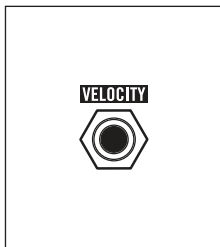

### **VELOCITY (SEQUENCER VELOCITY CONTROL VOLTAGE OUTPUT)**

This output provides a voltage that varies based on the **VELOCITY** setting of the currently selected Sequencer step.

#### **OUTPUT**

0V to +5V Control Voltage

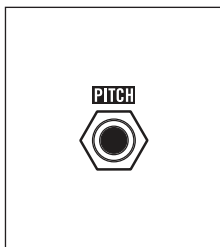

### **PITCH (SEQUENCER PITCH CONTROL VOLTAGE OUTPUT)**

This output provides a voltage that varies based on the Pitch setting of the currently selected Sequencer step.

#### **OUTPUT**

-5V to +5V Control Voltage

# SYNCING MULTIPLE DFAMS

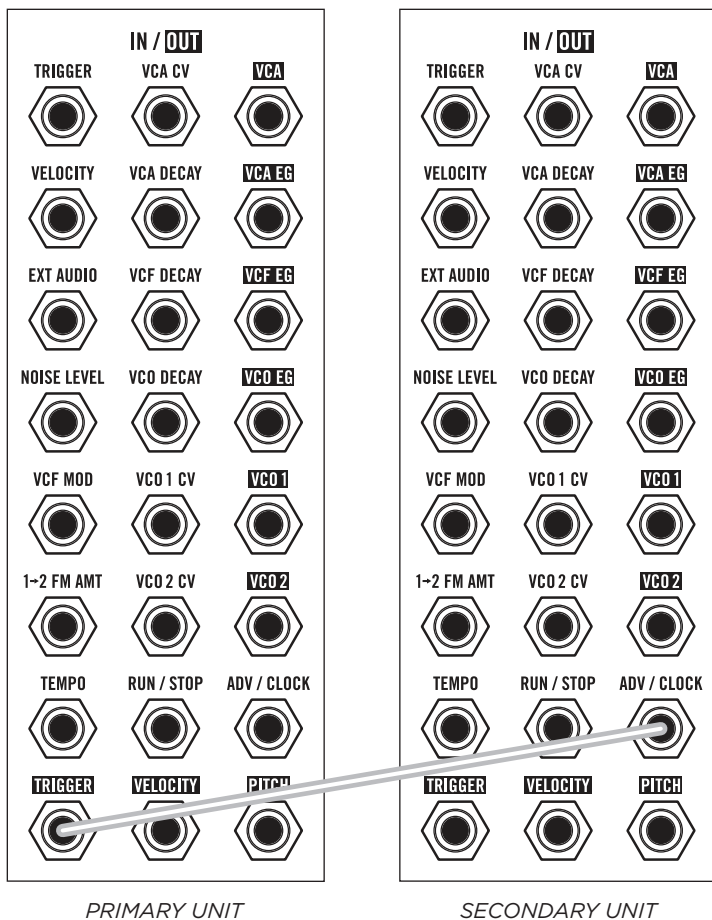

To Sync multiple DFAM units together, simply patch from the **TRIGGER** output on the Patchbay of the Primary unit, into the **ADV / CLOCK** input on the Secondary unit.

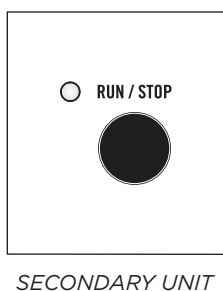

Press **RUN / STOP** on the Secondary unit first. This will ensure that it is ready to play when it begins receiving a Clock signal from the Primary unit.

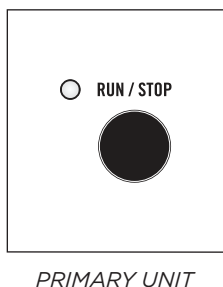

Press **RUN / STOP** on the Primary unit. Both units should now be playing in sync.

# SYNCING DFAM WITH A MOTHER-32

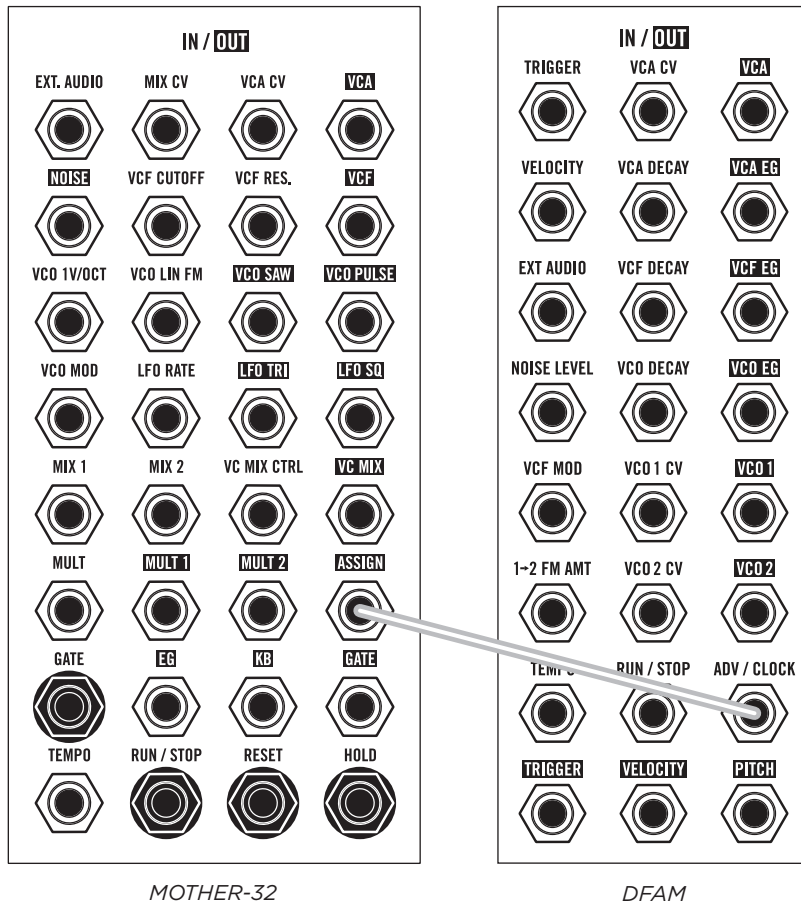

To Sync your DFAM to a Mother-32, simply patch from the **ASSIGN** output jack on the Mother-32 Patchbay, into the **ADV / CLOCK** input on the DFAM.

**IMPORTANT NOTE:** You will need to ensure that the Mother-32's Assignable output is set to transmit clock. To learn more about Mother-32's Assignable output, see pages 44, 49, and 50 in the Mother-32 User's Manual.

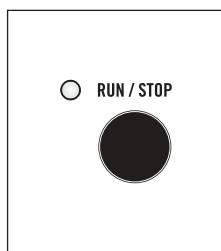

DFAM

Press **RUN / STOP** on your DFAM. This will ensure that it is ready to play when it begins receiving a Clock signal from the Mother-32.

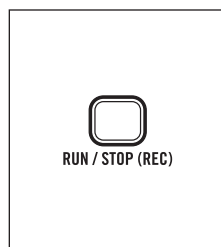

MOTHER-32

Press **RUN / STOP** on the Mother-32. Both units should now be playing in sync.

**TIP:** Mother-32 can transmit different clock divisions depending on its internal settings. Experimenting with these clock divisions allows DFAM to play in sync with Mother-32, but at a division of the master tempo.

## USING DFAM AS A EURORACK MODULE

Your Drummer From Another Mother can be removed from its case, and easily installed into a Eurorack system as a 60HP module. Before doing this, it is important to note that the DFAM draws a maximum of 230mA from a +12V supply. It does not use the -12V supply at all.

Make sure there is enough headroom on the +12V supply in your system to power the DFAM. *You will need to know the current rating of the system's +12VDC supply, and the current draw of the +12VDC supply from all modules in the system combined. The sum of all current draw at +12VDC should never exceed the power supply rating. Note that it is good practice to leave some headroom to reduce stress on the supply.*

**Moog accepts NO responsibility or liability for improperly installed modules.**

### TO INSTALL THE DFAM IN A EURORACK SYSTEM

1. Disconnect external power from the unit.
2. Remove the eight black M3 screws on the front panel and keep them somewhere safe.
3. Lift the panel slowly from the bottom so you can see the two cables going to the Front Panel module.
4. Disconnect the two cables from the front panel. Now the module is free from its enclosure.

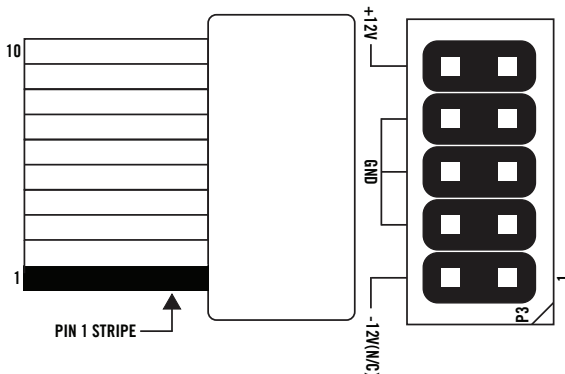

5. Look at the back of your DFAM module. There is a 10-pin power header on the back of the PCB that accepts a 10-pin Eurorack power ribbon cable.

6. Connect PIN-1 (-12V) of the power ribbon cable to PIN-1 of the DFAM Eurorack power header. The darkened wire (typically red) on the ribbon cable indicates the PIN-1 (-12V) side of the cable.

7. After power is connected, your DFAM may be installed into the rails of the Eurorack system case with the eight black M3 screws.
8. Once fully installed, you may power up your Eurorack system.



## PRESETS

Please note that your DFAM is 100% analog, and as a result, each unit has subtle sonic differences due to component tolerances that make it unique. This means that two different units set the same way may sound slightly different. This is normal.

**NOTE:** Additional presets and blank patch sheets can be downloaded at [www.moogmusic.com](http://www.moogmusic.com).

## MUSIC BOX

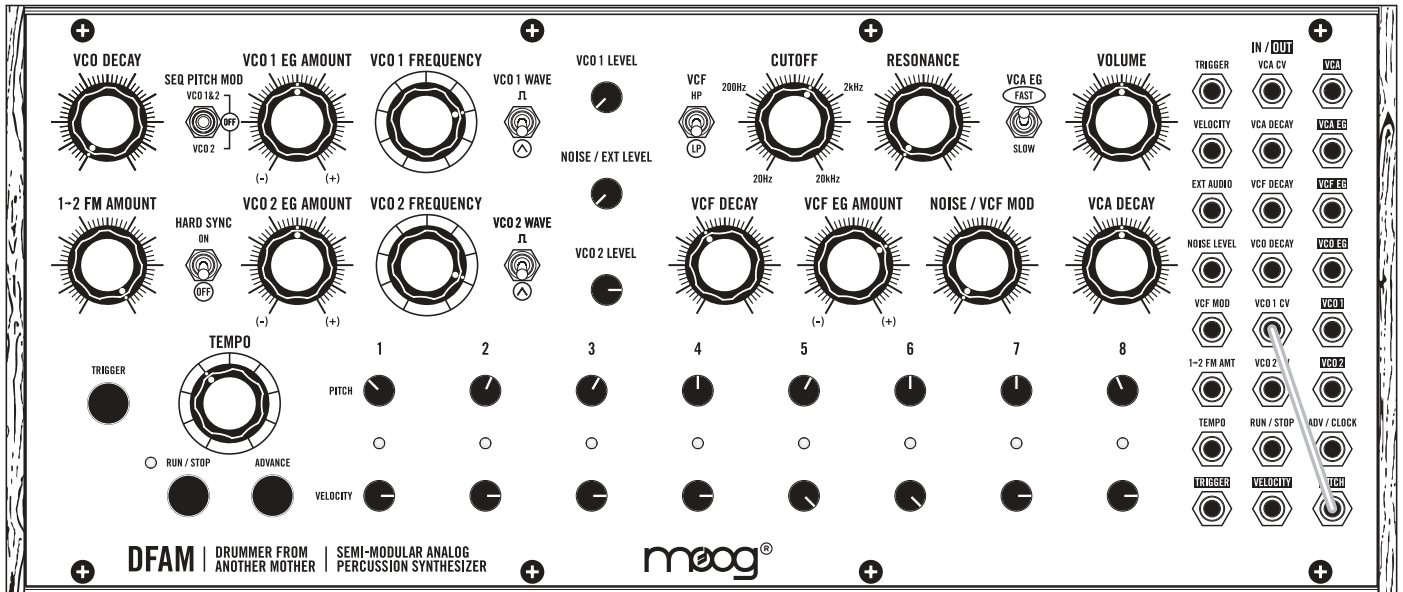

### NOTES

- The Sequencer **PITCH 1-8** knobs determine the Pitch of **VCO 1**
- Small tweaks to the Pitch of the sequence will have a large impact on tonality
- Try turning the **VCO 2 FREQUENCY** knob and listen to how it affects the sound

## QUICK HATS

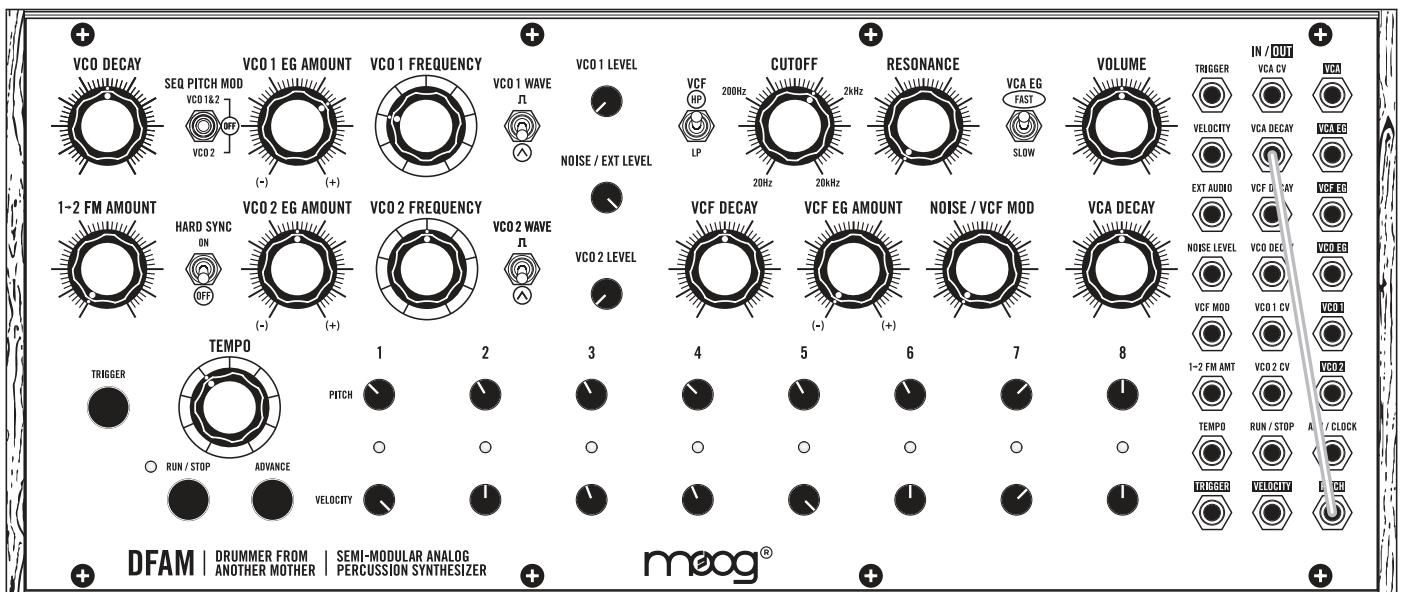

### NOTES

- The Sequencer **PITCH 1-8** knobs determine tightness per step
- Experiment with the Sequencer **VELOCITY 1-8** knobs

## FM TOYS

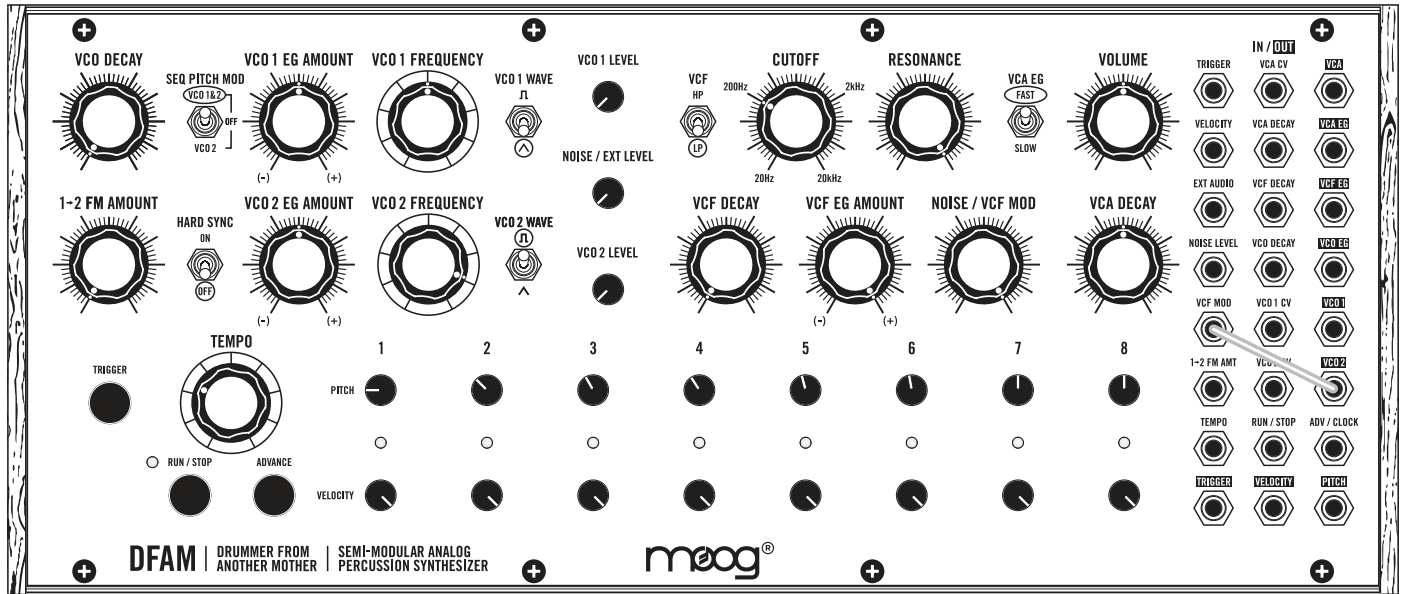

### NOTES

- **VCO 2** is modulating the Filter Cutoff
- Try adjusting the **VCO 2 FREQUENCY** knob
- Listen to the difference between the VCF in LP and HP mode

## SEQUENCED BASS

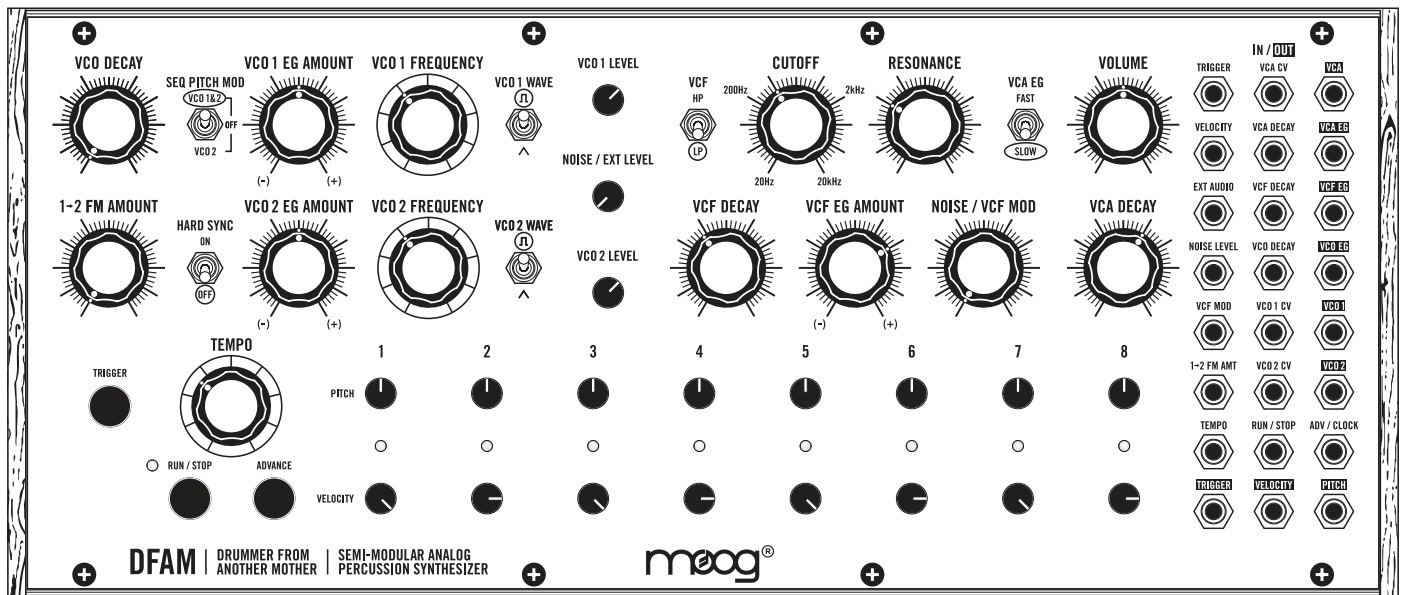

### NOTES

- Use the **VCO FREQUENCY** knobs to ensure **VCO 1** and **VCO 2** are exactly in tune
- Minor adjustments to the Sequencer **PITCH 1-8** knobs will add motion to your bass line
- Tweak the Filter **CUTOFF** knob to taste

## KICK / SNARE / FM OSC 2

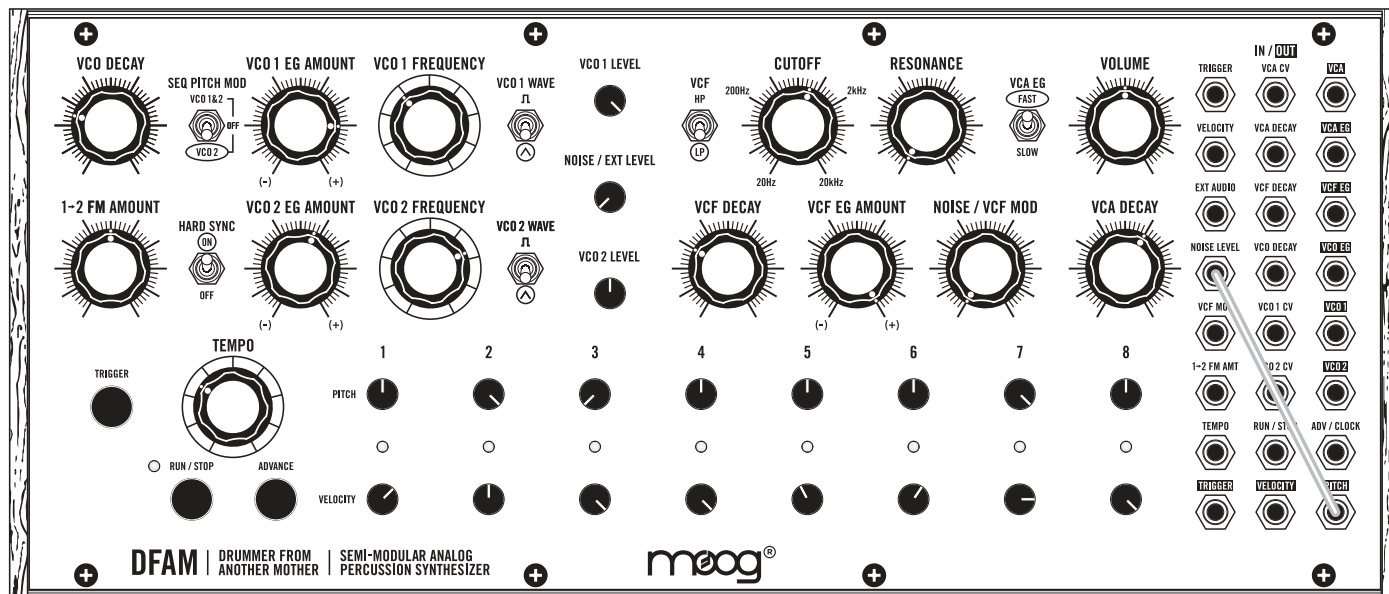

### NOTES

- The Sequencer **PITCH 1-8** knobs determine the voicing for each step
- The Sequencer **PITCH 1-8** knobs also determine the Snare volume
- Turn the Sequencer **VELOCITY 1-8** knobs up and down to vary the Kick pattern

## FILTER AS AN OSCILLATOR

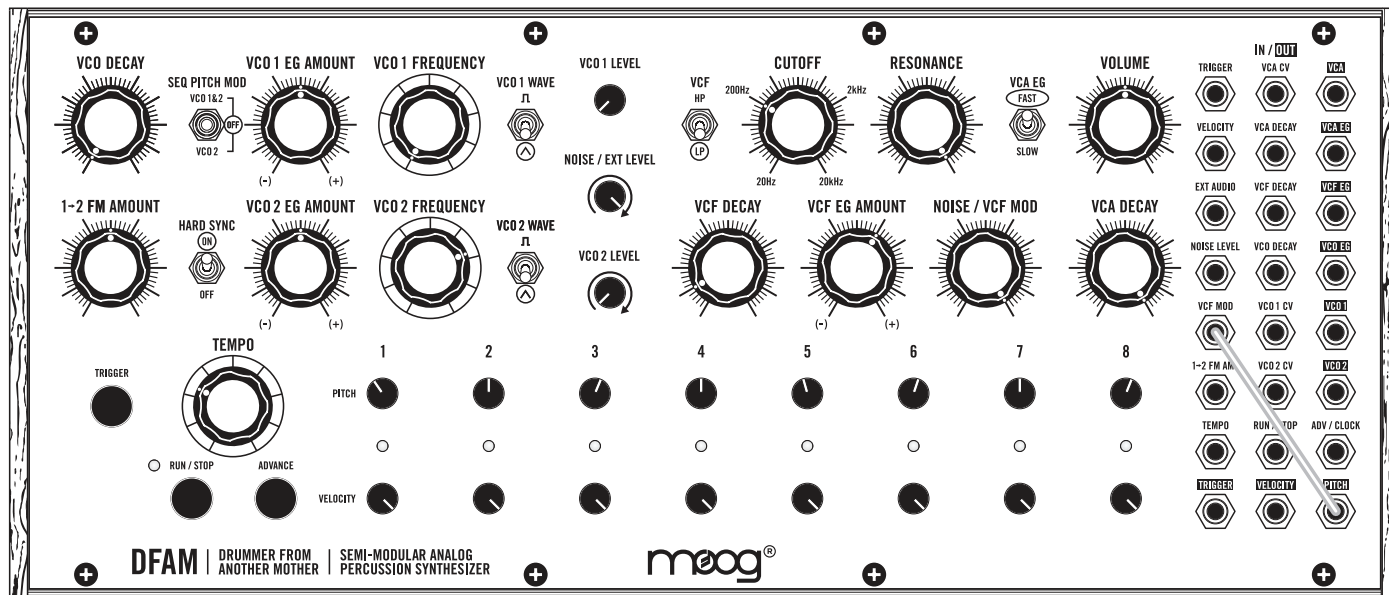

### NOTES

- The Filter **CUTOFF** knob is being controlled by the Sequencer **PITCH 1-8** knobs
- Turn up the **VCO 2 LEVEL** control to add a watery wobble
- Increasing the **NOISE / EXT LEVEL** will add a more ghostly tone to the sound

## INSANE TOMS

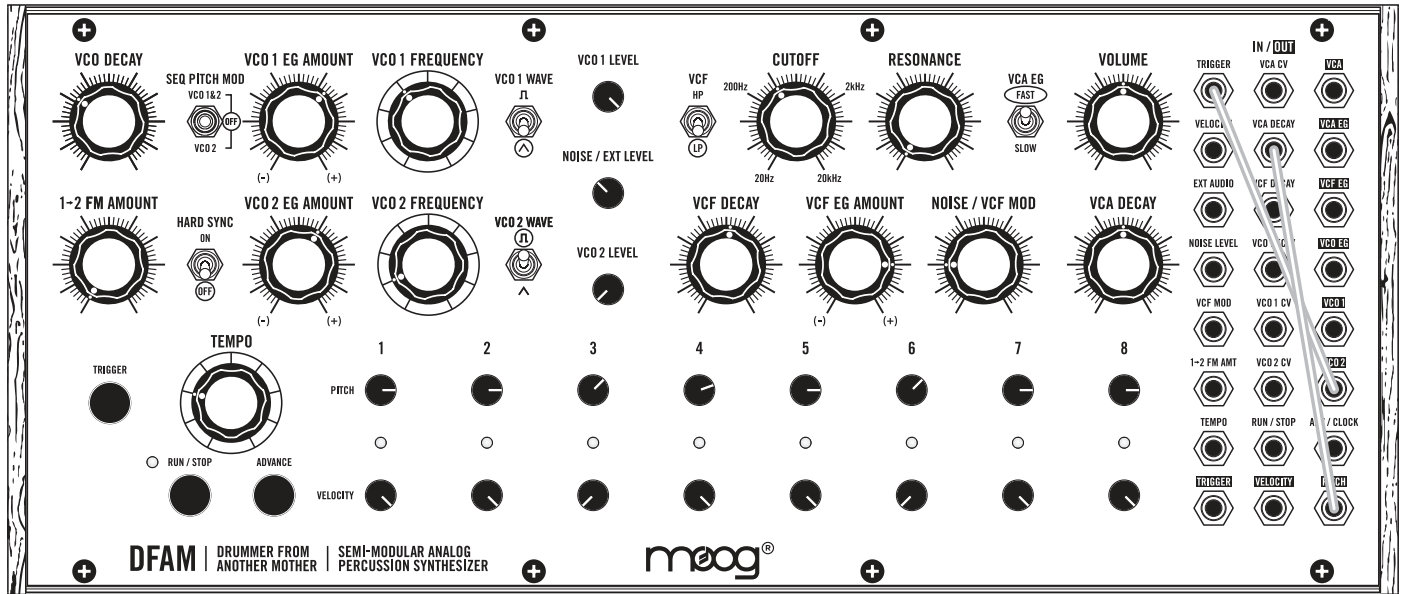

### NOTES

- **VCO 2** is adding extra triggers
- Try experimenting with the **VCO 2 EG AMOUNT** knob
- The Sequencer **PITCH 1-8** knobs determine how each hit rings out

## SWING TIME

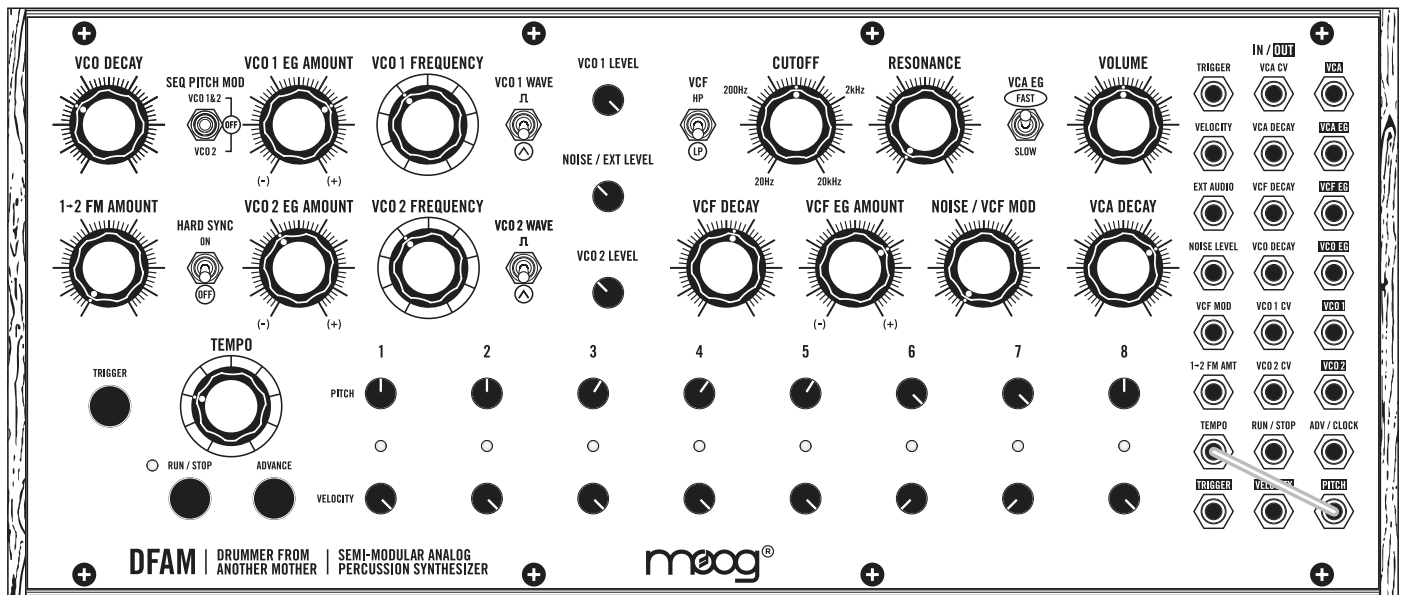

### NOTES

- The Sequencer **PITCH 1-8** knobs determine the length of each Step in a Sequence
- Lower Sequencer **PITCH** settings will result in extremely long step lengths
- Higher Sequencer **PITCH** settings will result in extremely short step lengths

## SEQUENCER AS AN OSCILLATOR

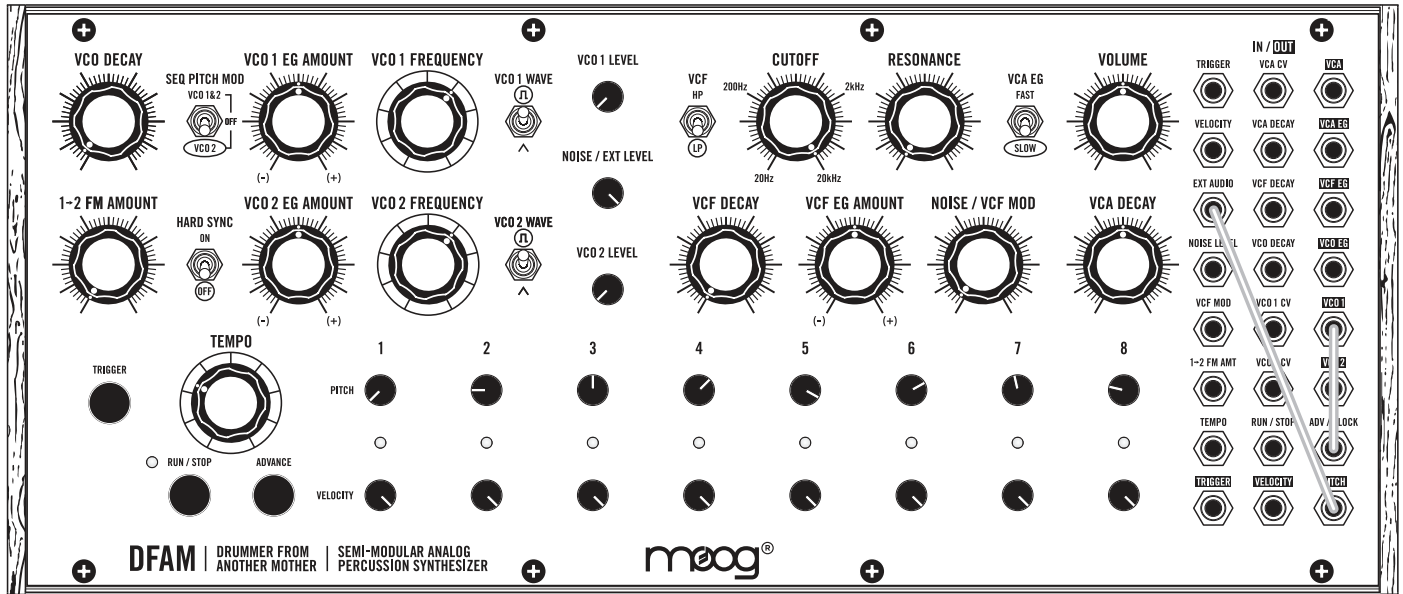

### NOTES

- The **VCO 1 FREQUENCY** knob controls the Sequencer Rate and Pitch
- The Sequencer **PITCH 1-8** knobs alter and shape the waveform
- Add some **VCO 2 LEVEL** for wild sounds

## TALKING DRUM

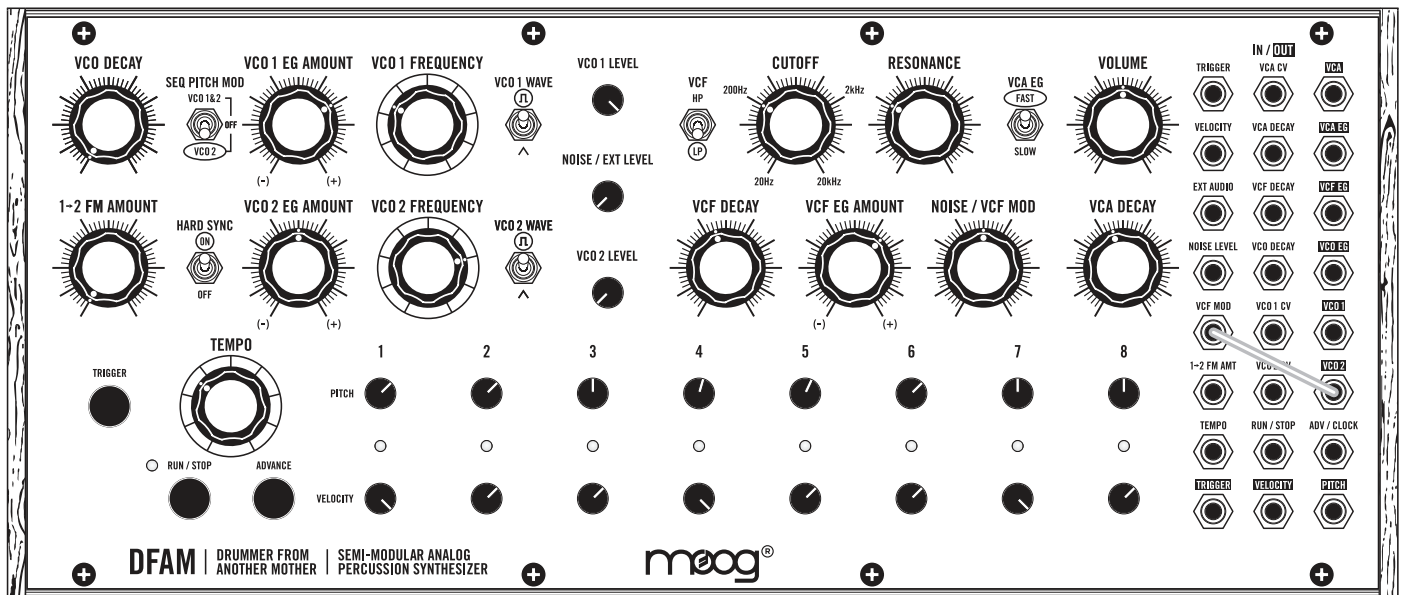

### NOTES

- **VCO 2** is modulating the Filter Cutoff position
- The **NOISE / VCF MOD** knob determines how vocal the drum is
- Turn the **RESONANCE** knob down to add more thump

**PRESET NAME:**

**DFAM | DRUMMER FROM ANOTHER MOTHER | SEMI-MODULAR ANALOG PERCUSSION SYNTHESIZER**

**moog®**

**NOTES**

**PRESET NAME:**

**DFAM | DRUMMER FROM ANOTHER MOTHER | SEMI-MODULAR ANALOG PERCUSSION SYNTHESIZER**

**moog®**

**NOTES**

**PRESET NAME:**

**DFAM** | DRUMMER FROM ANOTHER MOTHER | SEMI-MODULAR ANALOG PERCUSSION SYNTHESIZER

**moog**

**NOTES**

**PRESET NAME:**

**DFAM** | DRUMMER FROM ANOTHER MOTHER | SEMI-MODULAR ANALOG PERCUSSION SYNTHESIZER

**moog**

**NOTES**

# SPECIFICATIONS

## ANALOG SOUND ENGINE

**SOURCES:** VCO 1, VCO 2, White Noise Generator

**FILTER:** Selectable High Pass/Low Pass 4-pole (-24dB/Oct) Ladder Filter

**MODULATION:** VCO EG with Voltage Controlled Decay, VCF EG with Voltage Controlled Decay Time, VCA EG with with Voltage Controlled Decay Time and selectable Attack Time

## ANALOG SEQUENCER

**CONTROL:** 8 Steps with dedicated PITCH and VELOCITY knobs per step

**TEMPO:** 10 BPM to 10,000 BPM

**OTHER:** Manual Trigger and Advance buttons

## PATCHBAY

**JACKS:** 24x 3.5mm

**INPUTS:** 15x 3.5mm

**OUTPUTS:** 9x 3.5mm

## REAR PANEL

**AUDIO:** 1/4" TRS Headphone or 1/4" TS Instrument

**POWER:** Connection for external power supply

## DIMENSIONS

**SIZE (W X D X H):** 12.57" x 4.21" x 5.24

**WEIGHT:** 3.5lbs

## POWER SUPPLY (INCLUDED)

**STYLE:** Wall adaptor; barrel connection, center-pin positive

**INPUT:** 100 - 240VAC; 50Hz - 60Hz

**OUTPUT:** +12VDC; 1200mA

## POWER CONSUMPTION

**TYPICAL:** 3.0 Watts

## EURORACK SPECS

**CURRENT DRAW:** 230mA (maximum) from +12VDC (10-pin header)

**MOUNTING DIMS:** 60HP (1"/26mm Module Depth)

*All specifications subject to change without notice.*

## ACCESSORIES

The following accessories are available at authorized Moog dealers.

### 2-TIER VERTICAL RACK KIT

### 3-TIER VERTICAL RACK KIT

### GIG BAG

### 6" 3.5mm CABLE PACK (QTY 5)

### 12" 3.5mm CABLE PACK (QTY 5)

### EMPTY 60HP & 120HP CASE

### BACKUP POWER SUPPLY



## SERVICE AND SUPPORT INFORMATION

### MOOG'S STANDARD WARRANTY

Moog warrants its products to be free of defects in materials or workmanship and conforming to specifications at the time of shipment. The Warranty Period is one year from the date of purchase. If, in Moog's determination, it has been more than five years since the product shipped from our factory, it will be at Moog's discretion whether or not to honor the warranty without regard to the date of the purchase. During the Warranty Period, any defective products will be repaired or replaced, at Moog's option, on a return-to-factory basis. This warranty covers defects that Moog determines are no fault of the user.

The Moog Limited Warranty applies to USA purchasers only. Outside the USA the warranty policy and associated service is determined by the laws of the country of purchase and supported by our local authorized distributor. A listing of our authorized distributors is available at [moogmusic.com](http://moogmusic.com).

If you purchase outside of your country, you can expect to be charged for warranty as well as non-warranty service by the service center in your country.

### RETURNING YOUR PRODUCT TO MOOG MUSIC

You must obtain prior approval in the form of an RMA (Return Material Authorization) number from Moog before returning any product. Email [techsupport@moogmusic.com](mailto:techsupport@moogmusic.com) for the RMA number via email or call us at (828) 251-0090. All products must be packed carefully and shipped with the Moog supplied power adapter. The DFAM must be returned in the original inner packing including the cardboard inserts. Sorry, the warranty will not be honored if the product is not properly packed. Once you have received the RMA number and carefully packed your Moog, ship the product to Moog Music Inc. with transportation and insurance charges paid, and be sure to include your return shipping address.

**MOOG MUSIC**  
160 Broadway St.  
Asheville NC, 28801

### WHAT WE WILL DO

Once received, we will examine the product for any obvious signs of user abuse or damage as a result of transport. If the product abused, damaged in transit, or is out of warranty, we will contact you with an estimate of the repair cost. Warranty work will be performed and Moog will ship and insure your product to your United States address free of charge.

### HOW TO INITIATE YOUR WARRANTY

Please initiate your warranty online at [www.moogmusic.com/register](http://www.moogmusic.com/register). If you do not have web access, please call (828) 251-0090 to register your product.

### CARING FOR THE DRUMMER FROM ANOTHER MOTHER

Clean the DFAM with a soft, dry cloth only - do not use solvents or abrasive detergents. Heed the safety warnings at the beginning of the manual. Do not drop the unit.

**AN IMPORTANT NOTE ABOUT SAFETY:** *There are no user serviceable parts in the DFAM. Refer all servicing to qualified personnel only.*

©2017 MOOG MUSIC INC. | 160 Broadway St. Asheville, NC 28801

Moog is a registered trademark of Moog Music Inc.

The Moog Wordmark is a registered trademark of Moog Music Inc.

The Moog Icon is a registered trademark of Moog Music Inc.

DFAM is a trademark of Moog Music Inc.

Drummer From Another Mother is a trademark of Moog Music Inc.

All rights reserved to Moog Music Inc. on all text & graphics here within.

Phone: 828.251.0090 | Email: [info@moogmusic.com](mailto:info@moogmusic.com) | Website: [www.moogmusic.com](http://www.moogmusic.com)





