

# SUPER-X<sup>®</sup> PRO CX3400

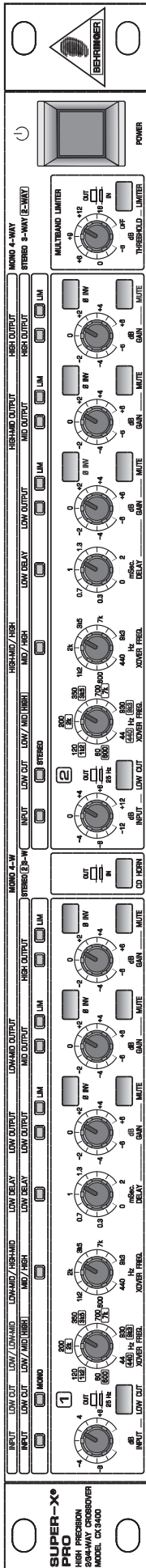

## User's Manual

Version 1.1 November 2000

ENGLISH



[www.behringer.com](http://www.behringer.com)

## SAFETY INSTRUCTIONS

**CAUTION:** To reduce the risk of electrical shock, do not remove the cover (or back). No user serviceable parts inside; refer servicing to qualified personnel.



**WARNING:** To reduce the risk of fire or electrical shock, do not expose this appliance to rain or moisture.



This symbol, wherever it appears, alerts you to the presence of uninsulated dangerous voltage inside the enclosure - voltage that may be sufficient to constitute a risk of shock.



This symbol, wherever it appears, alerts you to important operating and maintenance instructions in the accompanying literature. Read the manual.

### DETAILED SAFETY INSTRUCTIONS:

All the safety and operation instructions should be read before the appliance is operated.

#### **Retain Instructions:**

The safety and operating instructions should be retained for future reference.

#### **Heed Warnings:**

All warnings on the appliance and in the operating instructions should be adhered to.

#### **Follow instructions:**

All operation and user instructions should be followed.

#### **Water and Moisture:**

The appliance should not be used near water (e.g. near a bathtub, washbowl, kitchen sink, laundry tub, in a wet basement, or near a swimming pool etc.).

#### **Ventilation:**

The appliance should be situated so that its location or position does not interfere with its proper ventilation. For example, the appliance should not be situated on a bed, sofa rug, or similar surface that may block the ventilation openings, or placed in a built-in installation, such as a bookcase or cabinet that may impede the flow of air through the ventilation openings.

#### **Heat:**

The appliance should be situated away from heat sources such as radiators, heat registers, stoves, or other appliance (including amplifiers) that produce heat.

#### **Power Source:**

The appliance should be connected to a power supply only of the type described in the operating instructions or as marked on the appliance.

#### **Grounding or Polarization:**

Precautions should be taken so that the grounding or polarization means of an appliance is not defeated.

#### **Power-Cord Protection:**

Power supply cords should be routed so that they are not likely to be walked on or pinched by items placed upon or against them, paying particular attention to cords and plugs, convenience receptacles and the point where they exit from the appliance.

#### **Cleaning:**

The appliance should be cleaned only as recommended by the manufacturer.

#### **Non-use Periods:**

The power cord of the appliance should be unplugged from the outlet when left unused for a long period of time.

#### **Object and Liquid Entry:**

Care should be taken so that objects do not fall and liquids are not spilled into the enclosure through openings.

#### **Damage Requiring Service:**

The appliance should be serviced by qualified service personnel when:

- The power supply cord or the plug has been damaged; or
- Objects have fallen, or liquid has been spilled into the appliance; or
- The appliance has been exposed to rain; or
- The appliance does not appear to operate normally or exhibits a marked change in performance; or
- The appliance has been dropped, or the enclosure damaged.

#### **Servicing:**

The user should not attempt to service the appliance beyond that is described in the Operating Instructions. All other servicing should be referred to qualified service personnel.

## FOREWORD

Dear Customer,

Welcome to the team of SUPER-X PRO users and thank you very much for expressing your confidence in BEHRINGER products by purchasing this crossover.

It is one of my most pleasant tasks to write this letter to you, because it is the culmination of many months of hard work delivered by our engineering team to reach a very ambitious goal: making an outstanding device that will become a standard tool used by P.A. companies and studios. The task to design the SUPER-X PRO certainly meant a great deal of responsibility, which we assumed by focusing on you, the discerning user and musician. It also meant a lot of work and night shifts to accomplish this goal. But it was fun, too. Developing a product usually brings a lot of people together, and what a great feeling it is when everybody who participated in such a project can be proud of what we've achieved.

It is our philosophy to share our joy with you, because you are the most important member of the BEHRINGER family. With your highly competent suggestions for new products you've greatly contributed to shaping our company and making it successful. In return, we guarantee you uncompromising quality (manufactured under ISO9000 certified management system) as well as excellent technical and audio properties at an extremely favorable price. All of this will enable you to fully unfold your creativity without being hampered by budget constraints.

We are often asked how we can make it to produce such high-grade devices at such unbelievably low prices. The answer is quite simple: it's you, our customers! Many satisfied customers means large sales volumes enabling us to get better conditions of purchase for components, etc. Isn't it only fair to pass this benefit back to you? Because we know that your success is our success, too!

I would like to thank all people whose help on "Project SUPER-X PRO" has made it all possible. Everybody has made very personal contributions, starting from the designers of the unit via the many staff members in our company to you, the user of BEHRINGER products.

My friends, it's been worth the trouble!

Thank you very much,

A handwritten signature in black ink, appearing to read 'U. Behringer', with a long horizontal flourish extending to the right.

Uli Behringer

# SUPER-X<sup>®</sup> PRO

HIGH-PRECISION STEREO 2-WAY / 3-WAY / MONO 4-WAY CROSSOVER WITH LIMITERS MODEL CX 3400

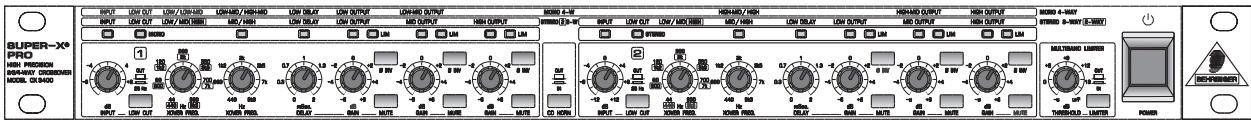

- ▲ Professional high-precision stereo 2-way / 3-way / mono 4-way crossover
- ▲ World-class performance 24 dB per octave Linkwitz-Riley filters
- ▲ Absolutely flat summed amplitude response, zero phase difference
- ▲ Individual output level controls for all bands
- ▲ Individual limiter on each output for optimal loudspeaker protection
- ▲ Individual output mutes for easy band adjustment
- ▲ Individual phase reverse switches for instant phase correction
- ▲ Switchable 25 Hz subsonic filter on each input for low-frequency driver protection
- ▲ “Low Sum” function provides low-level mono output for subwoofer operation
- ▲ Adjustable time delay for phase alignment between drivers
- ▲ CD horn equalization for constant directivity horn compensation
- ▲ Servo-balanced, gold-plated XLR connectors for all inputs and outputs
- ▲ Ultra high-precision ALPS potentiometers for ultimate accuracy and repeatability
- ▲ Ultra low-noise audio operational 4580 amplifiers for outstanding sound performance
- ▲ Illuminated switches for secure operation in dark stage environments
- ▲ High-quality components and exceptionally rugged construction for long life and reliability
- ▲ Shielded toroidal mains transformer for minimal noise interference
- ▲ Manufactured under the stringent ISO9000 certified management system

---

# TABLE OF CONTENTS

<b>1. INTRODUCTION .....</b>	<b>6</b>
1.1 Multi-way speaker systems .....	6
1.2 SUPER-X PRO: the high-end frequency crossover .....	6
<b>2. THE DESIGN CONCEPT .....</b>	<b>6</b>
2.1 Before you begin .....	7
2.2 Control elements .....	7
2.2.1 Stereo 2-way operation .....	7
2.2.2 Stereo 3-way operation .....	9
2.2.3 Mono 4-way operation .....	11
<b>3. APPLICATION .....</b>	<b>13</b>
3.1 Tools .....	13
3.1.1 Measuring microphone .....	13
3.1.2 Generator/Analyzer .....	13
3.1.3 Your ears .....	13
3.2 Setting the input levels .....	13
3.3 Setting the output levels .....	13
3.3.1 Finding “drop-outs” in the frequency response .....	14
3.4 Setting the crossover frequencies .....	14
3.5 Runtime Correction .....	14
3.5.1 Background .....	14
3.5.2 Basics of electronic runtime correction .....	15
3.5.3 Runtime correction in a P.A. system using the SUPER-X PRO .....	15
3.6 The limiters of the SUPER-X PRO .....	16
3.6.1 Limiter setup .....	17
3.7 LOW SUM function .....	17
3.8 CD HORN function .....	17
<b>4. INSTALLATION .....</b>	<b>17</b>
4.1 Rack mounting .....	17
4.2 Mains connection .....	18
4.3 Audio connections .....	18
<b>5. SPECIFICATIONS .....</b>	<b>19</b>
<b>6. WARRANTY .....</b>	<b>21</b>

## 1. INTRODUCTION

Thank you very much for expressing your confidence in BEHRINGER products by purchasing the SUPER-X PRO CX3400.

 **This manual first describes the terminology used, so that you can fully understand the CX3400 and its functions. Please read the manual carefully and keep it for future reference.**

### 1.1 Multi-way speaker systems

Multi-way speaker systems can be found almost everywhere today – not only in stereo systems, cinemas, discotheques and concert halls. As “customers” become more and more demanding, even such “simple” products as TV sets have them installed. Why?

With the same sound pressure level, low-frequency sound waves have a much greater amplitude than high-frequency signals. When a single loudspeaker is to produce both bass and treble frequencies, so-called intermodulation distortion will occur.

Don't worry about unfamiliar terminology! Everybody knows the effect that the sound of a fire engine's siren seems to become lower in frequency, once it has passed you. So, the perceived frequency is affected by the motion of the sound source or the listener. This phenomenon is called Doppler effect (thanks to Mr. Doppler who discovered it) and can also be found in loudspeakers: as the speaker diaphragm is displaced by low frequencies, the treble frequencies seem to be raised in loudness, or lowered when the diaphragm reverses its direction. Quite similar in sound to a vibrato, it is precisely this effect that we call intermodulation distortion.

As a consequence, we cannot expect a single loudspeaker to reproduce signals with the same quality over the entire audio spectrum. Therefore, 2, 3 or 4-way systems have become the standard today. Speakers that need to reproduce only a limited range of the audio spectrum can accomplish this task with much greater accuracy, i.e. they produce a more regular frequency response and dispersion pattern.

To operate a speaker system that consists of several loudspeakers for the various frequency ranges, you have to provide a variety of input signals for the single speakers. For this purpose, crossover networks split up the input signal into several frequency bands. You can use passive crossovers wired between amplifier and speaker, or active systems placed before the amplifier in the signal chain. Passive crossovers are usually employed in hi-fi speaker boxes.

### 1.2 SUPER-X PRO: the high-end frequency crossover

The BEHRINGER SUPER-X PRO CX3400 is a high-quality active crossover network that can be used for 2, 3 or even 4-way sound reinforcement systems.

Whether you need to set up a system for small clubs or large halls, improve an on-stage monitoring system or enhance your studio monitors with an additional subwoofer: your SUPER-X PRO is the ideal choice for all of these applications.

## 2. THE DESIGN CONCEPT

The philosophy behind BEHRINGER products guarantees a no-compromise circuit design and employs the best choice of components. The operational amplifiers NJM4580 which are used in the SUPER-X PRO, are exceptional. They boast extreme linearity and very low distortion characteristics. To complement this design the choice of components includes low-tolerance resistors and capacitors, high-quality potentiometers and several other stringently selected elements.

The CX3400 uses SMD technology (Surface Mounted Device). These subminiature components adapted from aerospace technology allow for an extreme packing density to further improve the overall reliability. Additionally, the unit is manufactured in compliance with the ISO9000 certified management system.

## 2.1 Before you begin

Your BEHRINGER SUPER-X PRO CX3400 was carefully packed in the factory and the packaging is designed to protect the unit from rough handling. Nevertheless, we recommend that you carefully examine the packaging and its contents for any signs of physical damage, which may have occurred during transit.

**👉 If the unit is damaged, please do not return it to BEHRINGER, but notify your dealer and the shipping company immediately, otherwise claims for damage or replacement may not be granted. Shipping claims must be made by the consignee.**

Your BEHRINGER SUPER-X PRO requires 1 height unit of rack space (1 HU). Please allow for an additional 10 cm of rack depth for the rear-panel connectors.

Be sure that there is enough space around the unit for cooling and please do not place the CX3400 on high-temperature devices such as radiators etc. to avoid overheating.

**👉 Before you connect your SUPER-X PRO to the mains, please make sure that your local voltage matches the voltage required by the unit!**

The mains connection of the CX3400 is made by using the enclosed mains cable and a standard IEC receptacle. It meets all of the international safety certification requirements.

**👉 Please make sure that all units have a proper ground connection. For your own safety, never remove or disable the ground conductor of the unit or of the AC power cable.**

As a standard, the BEHRINGER SUPER-X PRO is equipped with electronically servo-balanced inputs and outputs. The circuit design features automatic hum and noise reduction for balanced signals and thus allows for trouble-free operation, even at high operating levels. Externally induced mains hum, etc. will be effectively suppressed. The automatic servo-function recognizes the presence of unbalanced connectors and adjusts the nominal level internally to avoid level differences between the input and output signals (6-dB correction).

Further information can be found in chapter 4 "INSTALLATION".

## 2.2 Control elements

Since the SUPER-X PRO boasts a variety of features, we highlighted the active control elements in the following illustrations. On the unit itself, these active elements are equipped with light-emitting diodes, helping you to keep track of your settings even under poor lighting conditions. Additionally, all buttons on the front panel are backlit when activated. Above the control elements there are two labels in the form of strips which refer to mono 4-way (upper) or stereo 2/3-way (lower) configuration. The LEDs below these strips show which controls are active in the respective operating mode.

**👉 On the rear panel, labels above/below the connectors refer to the various crossover modes available. Please make sure that the two MODE switches and corresponding connectors are configured properly; otherwise, you could damage your speakers.**

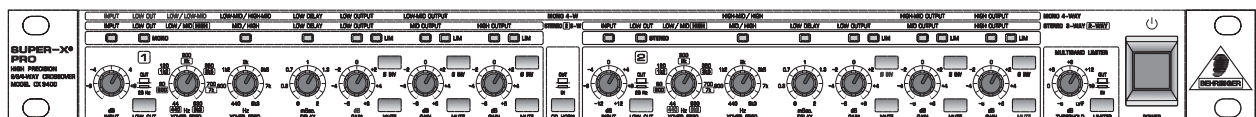

Fig. 2.1: The front panel of the SUPER-X PRO

### 2.2.1 Stereo 2-way operation

First, activate stereo 2-way mode by means of the two MODE buttons on the rear panel. The STEREO-LED on the front panel, above the LOW CUT button in channel 2, lights up.

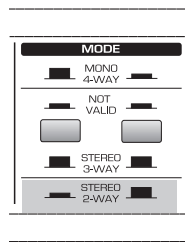

Fig. 2.2: Proper selection of the two MODE buttons for stereo 2-way operation

Subsequently, the LEDs above the active controls on the front panel light up, signaling which controls are active in the operating mode you just selected. The functions of these controls can be seen from the second strip label. In stereo mode, both channels perform the same functions.

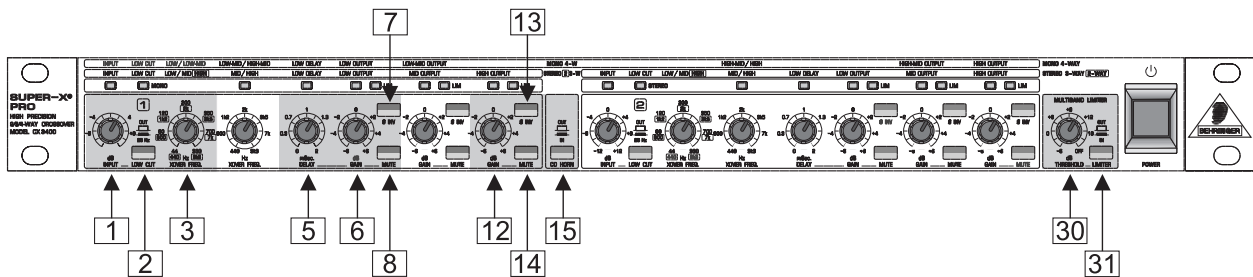

Fig. 2.3: Active control elements on the front panel of the SUPER-X PRO for stereo 2-way operation

- 1 **INPUT control.** This control adjusts the input gain from +12 to -12 dB (see control 16).
- 2 **LOW CUT button.** This button activates the 25 Hz highpass filter protecting the woofers against low-frequency signals.
- 3 **LOW/HIGH XOVER FREQ. control.** This control governs the crossover frequency between the Low and High bands. When the XOVER FREQUENCY button on the rear of the unit is pressed, the frequency range is multiplied by the factor 10.
- 5 **DELAY control.** This control delays the Low signal by as much as 2 ms, which is useful to align the speaker systems in phase.
- 6 **LOW OUTPUT control.** Controls the output level of the Low band from +6 to -6 dB.
- 7 **LOW PHASE INVERT button.** This button reverses the polarity of the Low output.
- 8 **LOW MUTE button.** Mutes the Low band.
- 12 **HIGH OUTPUT control.** Controls the output level of the High band from +6 to -6 dB.
- 13 **HIGH PHASE INVERT button.** This button reverses the polarity of the High output.
- 14 **HIGH MUTE button.** Mutes the High band.
- 15 **CD HORN button.** This button provides a special form of frequency correction in the High band for constant-directivity horns.
- 30 **THRESHOLD control.** This control determines the limiter threshold.
- 31 **LIMITER button.** This button activates all limiters. Whenever the signal surpasses the limiter threshold, the LIM-LEDs above the Gain control light up, signaling that the CX3400 cuts back the output level.



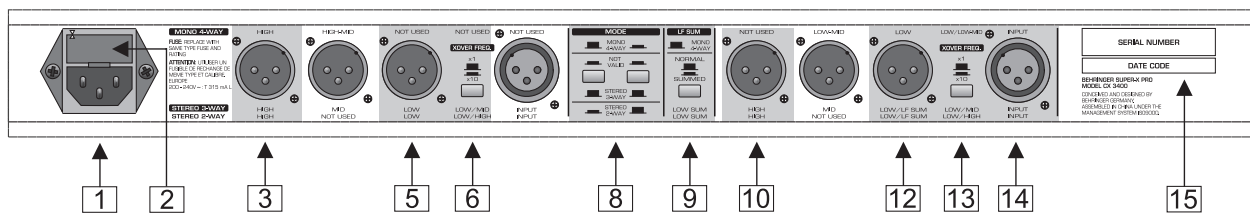

Fig. 2.4: Active control elements on the rear panel of the SUPER-X PRO for 2-way stereo operation

- 1 Use the enclosed power cord to connect the unit to the mains.
- 2 **FUSE HOLDER / VOLTAGE SELECTOR.** Please make sure that your local voltage matches the voltage indicated on the unit, before you attempt to connect and operate the CX3400. Blown fuses may only be replaced by fuses of the same type and rating. Some models allow for inserting the fuse holder in two different positions, in order to switch over from 230 V to 115 V operation, and vice versa. Please note that for 115 V operation outside Europe, you need to use a fuse of a higher rating (see chapter 4 "INSTALLATION").
- 3 and 10 **HIGH OUTPUT connector.** Output for the High band signal.
- 5 and 12 **LOW (LF SUM) OUTPUT connector.** Output for the Low band signal.
- 6 and 13 **XOVER FREQ. button.** This button serves to switch over the control range of the front-panel LOW/HIGH OVER FREQ. control from 44 to 930 Hz or 440 Hz to 9.3 kHz.
  - Always switch off the entire system before you press this button, as it produces heavy interference noise that could damage your speakers and/or other equipment.**
- 8 **MODE button.** In stereo 2-way mode, the first button must be pressed, the second released. Please observe the labels on the rear panel of the unit.
  - Always switch off the entire system before you press this button, as it produces heavy interference noise that could damage your speakers and/or other equipment.**
- 9 **LOW SUM button.** In stereo mode, the two Low paths can be summed with the LOW SUM button and routed to the Low output of channel 1, which is particularly useful in systems using additional subwoofers.
- 14 **INPUT connector.** Input signal connector.
- 15 **SERIAL NUMBER.** Please take the time to have the warranty card filled out completely by your specialized dealer, and return it within 14 days after the date of purchase, so as to be entitled to benefit from our extended warranty. Or use our online registration option available on the Internet at [www.behringer.com](http://www.behringer.com).

### 2.2.2 Stereo 3-way operation

First, activate stereo 3-way mode by means of the two MODE buttons on the rear panel. The STEREO-LED on the front panel, above the LOW CUT button in channel 2, lights up.

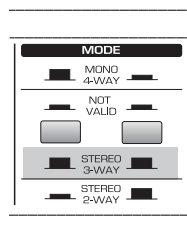

Fig. 2.5: Proper selection of the two MODE switches for stereo 3-way operation

Subsequently, the LEDs above the active controls on the front panel light up, signaling which controls are active in the operating mode you just selected. The functions of these controls can be seen from the second strip label. In stereo mode, both channels perform the same functions.

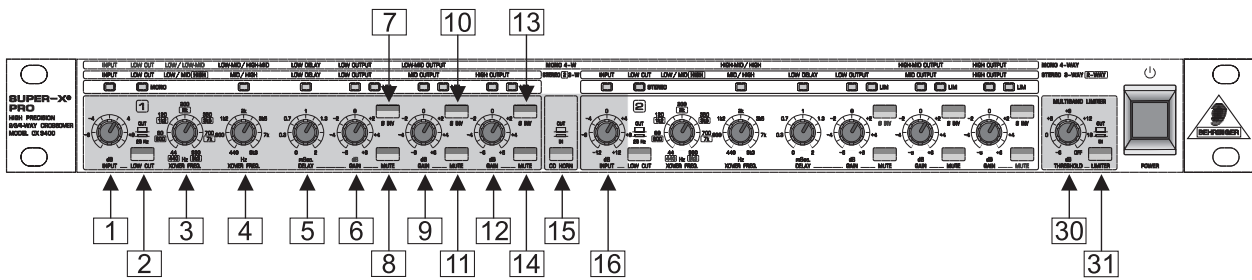

Fig. 2.6: Active control elements on the front panel of the SUPER-X PRO for stereo 3-way operation

- 1 and 16 **INPUT control.** This control adjusts the input gain from +12 to -12 dB.
- 2 **LOW CUT button.** This button activates the 25 Hz highpass filter protecting the woofers against low-frequency signals.
- 3 **LOW/MID XOVER FREQ. control.** This control governs the crossover frequency between the Low and Mid bands. When the XOVER FREQUENCY button on the rear of the unit is pressed, the frequency range is multiplied by the factor 10.
- 4 **MID/HIGH XOVER FREQ. control.** This control governs the crossover frequency between the Mid and High bands.
- 5 **DELAY control.** This control delays the Low signal by as much as 2 ms, which is useful to align the speaker systems in phase.
- 6 **LOW OUTPUT control.** Controls the output level of the Low band from +6 to -6 dB.
- 7 **LOW PHASE INVERT button.** This button reverses the polarity of the Low output.
- 8 **LOW MUTE button.** Mutes the Low band.
- 9 **MID OUTPUT control.** Controls the output level of the Mid band from +6 to -6 dB.
- 10 **MID PHASE INVERT button.** This button reverses the polarity of the Mid output.
- 11 **MID MUTE button.** Mutes the Mid band.
- 12 **HIGH OUTPUT control.** Controls the output level of the High band from +6 to -6 dB.
- 13 **HIGH PHASE INVERT button.** This button reverses the polarity of the High output.
- 14 **HIGH MUTE button.** Mutes the High band.
- 15 **CD HORN button.** This button provides a special form of frequency correction in the High band for constant-directivity horns.
- 30 **THRESHOLD control.** This control determines the limiter threshold.
- 31 **LIMITER button.** This button activates all limiters. Whenever the signal surpasses the limiter threshold, the LIM-LEDs above the Gain control light up, signaling that the CX3400 cuts back the output level.

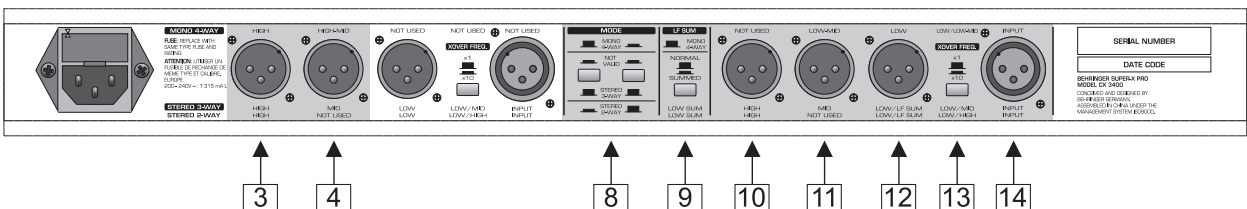



Fig. 2.7: Active control elements on the rear panel of the SUPER-X PRO for stereo 3-way operation

- 4 and 11 **MID OUTPUT connector.** Output for the Mid band signal.
- 3 and 10 **HIGH OUTPUT connector.** Output for the High band signal.
- 8 **MODE button.** In stereo 3-way mode, both buttons must be out. Please observe the labels on the rear panel of the unit.

-  **Always switch off the entire system before you press this button, as it produces heavy interference noise that could damage your speakers and/or other equipment.**
- 9 **LOW SUM button.** In stereo mode, the two Low paths can be summed with the LOW SUM button and routed to the Low output of channel 1, which is particularly useful in systems using additional subwoofers.
- 12 **LOW (LF SUM) OUTPUT connector.** Output for the Low band signal.
- 13 **XOVER FREQ. button.** This button serves to switch over the control range of the front-panel LOW/MID XOVER FREQ. control from 44 to 930 Hz or 440 Hz to 9.3 kHz.
-  **Always switch off the entire system before you press this button, as it produces heavy interference noise that could damage your speakers and/or other equipment.**
- 14 **INPUT connector.** Input signal connector.

### 2.2.3 Mono 4-way operation

First, activate mono 4-way mode by means of the two MODE buttons on the rear panel. The MONO-LED on the front panel, above the LOW CUT button in channel 1, lights up.

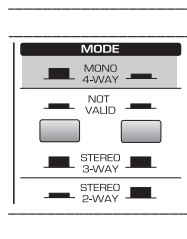

Fig. 2.8: Proper selection of the two MODE switches for mono 4-way operation

Subsequently, the LEDs above the active controls on the front panel light up, signaling which controls are active in the operating mode you just selected. The functions of these controls can be seen from the first strip label.

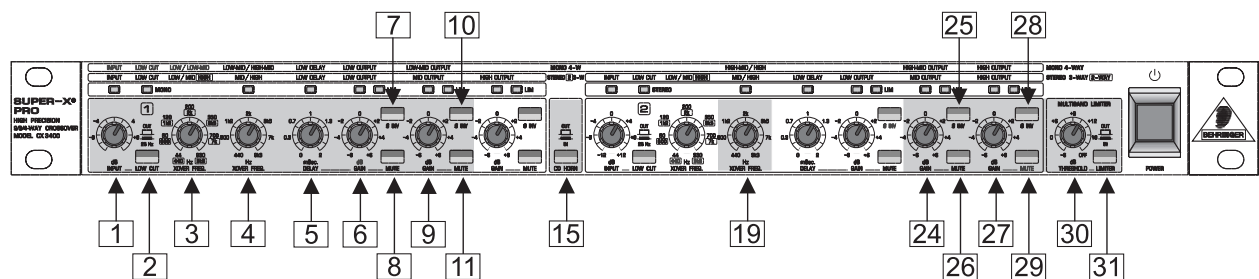

Fig. 2.9: Active control elements on the front panel of the SUPER-X PRO for mono 4-way operation

- 1 **INPUT control.** This control adjusts the input gain from +12 to -12 dB.
- 2 **LOW CUT button.** This button activates the 25 Hz highpass filter protecting the woofers against low-frequency signals.
- 3 **LOW/LOW-MID XOVER FREQ. control.** This control governs the crossover frequency between the Low and Low-Mid bands. When the XOVER FREQUENCY button on the rear of the unit is pressed, the frequency range is multiplied by the factor 10.
- 4 **LOW-MID/HIGH-MID XOVER FREQ. control.** This control governs the crossover frequency between the Low-Mid and High-Mid bands.
- 5 **DELAY control.** This control delays the Low signal by as much as 2 ms, which is useful to align the speaker systems in phase.

- 6 **LOW OUTPUT control.** Controls the output level of the Low band from +6 to -6 dB.
- 7 **LOW PHASE INVERT button.** This button reverses the polarity of the Low output.
- 8 **LOW MUTE button.** Mutes the Low band.
- 9 **LOW-MID OUTPUT control.** Controls the output level of the Low-Mid band from +6 to -6 dB.
- 10 **LOW-MID PHASE INVERT button.** This button reverses the polarity of the Low-Mid output.
- 11 **LOW-MID MUTE button.** Mutes the Low-Mid band.
- 15 **CD HORN button.** This button provides a special form of frequency correction in the High band for constant-directivity horns.
- 19 **HIGH-MID/HIGH XOVER FREQ. control.** This control governs the crossover frequency between the High-Mid and High bands.
- 24 **HIGH-MID OUTPUT control.** Controls the output level of the High-Mid band from +6 to -6 dB.
- 25 **HIGH-MID PHASE INVERT button.** This button reverses the polarity of the High-Mid output.
- 26 **HIGH-MID MUTE button.** Mutes the High-Mid band.
- 27 **HIGH OUTPUT control.** Controls the output level of the High band from +6 to -6 dB.
- 28 **HIGH PHASE INVERT button.** This button reverses the polarity of the High output.
- 29 **HIGH MUTE button.** Mutes the High band.
- 30 **THRESHOLD control.** This control determines the limiter threshold.
- 31 **LIMITER button.** This button activates all limiters. Whenever the signal surpasses the limiter threshold, the LIM-LEDs above the Gain control light up, signaling that the CX3400 cuts back the output level.

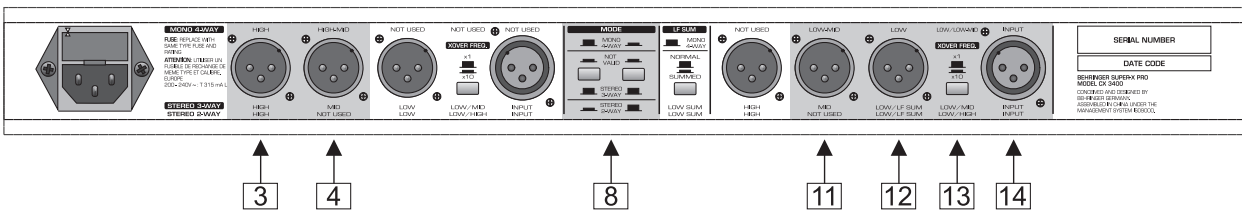



Fig. 2.10: Active control elements on the rear panel of the SUPER-X PRO for mono 4-way operation

- 3 **HIGH OUTPUT connector.** Output for the High band signal.
- 4 **HIGH-MID OUTPUT connector.** Output for the High-Mid band signal.
- 8 **MODE button.** In mono 4-way mode, the right button must be pressed. Please observe the labels on the rear panel of the unit.
-  **Always switch off the entire system before you press this button, as it produces heavy interference noise that could damage your speakers and/or other equipment.**
- 11 **LOW-MID OUTPUT connector.** Output for the Low-Mid band signal.
- 12 **LOW OUTPUT connector.** Output for the Low band signal.
- 13 **XOVER FREQ. button.** This button serves to switch over the control range of the front-panel LOW/LOW-MID XOVER FREQ. control from 44 to 930 Hz or 440 Hz to 9.3 kHz.
-  **Always switch off the entire system before you press this button, as it produces heavy interference noise that could damage your speakers and/or other equipment.**
- 14 **INPUT connector.** Input signal connector.

## 3. APPLICATION

### 3.1 Tools

The following tools are indispensable for a perfect system alignment. You should by all means try to obtain the speaker specifications from the manufacturer, in order to operate the systems in their proper frequency and level ranges. Use the manufacturer's documentation to adjust the operating mode and crossover frequencies.

 **BEHRINGER does not assume any responsibility for speaker damage caused by improper handling of the SUPER-X PRO.**

#### 3.1.1 Measuring microphone

For making measurements you need a high-grade microphone with a frequency response that should be as linear as possible over the entire frequency range (e.g. BEHRINGER measuring microphone ECM8000), or at least between 90 Hz and 15 kHz. Place the microphone about 5 m in front of the speaker system to be measured, in a height where it is on axis with the drivers of the two frequency bands you wish to measure. When setting the levels for the individual frequency bands, delay times and crossover frequencies by means of a measuring microphone, you should operate only one speaker stack each. Usually, the measuring microphone needs to be repositioned between two specific measurements.

#### 3.1.2 Generator/Analyzer

In combination with a measuring microphone and a generator producing pink noise that is fed into a channel of your P.A. console, an analyzer gives you a graph that shows how the acoustic energy is distributed among the various frequency bands (usually 1/3 of an octave). The equalizer/analyzer BEHRINGER ULTRA-CURVE PRO DSP8024 is the ideal tool for this application.

#### 3.1.3 Your ears

When you listen to the overall sound of your system, you should walk around in the audience area and try to detect resonance frequencies or cancellations. The sound should be optimized for the position where most of the audience will be gathered, however, without neglecting other areas. This often means that the system must be operated in mono. Whenever you use technical aids such as analyzers, measuring microphones, etc., you should check the results with your ears.

### 3.2 Setting the input levels

Both inputs provide a gain boost/cut of up to 12 dB. Normally, the output level of the mixing console and the input sensitivity of the power amp are the same, i.e. 0 dB in the console correspond to 0 dB in the amplifier. In this case, the power amp is fully driven and the SUPER-X PRO should have no influence on the system level, as all input/output controls are set to 0 dB. However, in a home recording or discotheque environment using operating levels of -10 dBV, the power amp would still need +4 dBu, which requires some additional gain of 12 dB. If so, the SUPER-X PRO's INPUT control must be set to maximum.

### 3.3 Setting the output levels

The output levels of the single bands can be raised/lowered by as much as 6 dB. To achieve a linear frequency response in the system, all output levels should be adjusted with the help of an analyzer. Then, mute all outputs except for one to check the crossover frequencies and levels, play back pink noise over the system at an appropriate volume level. Now, when you switch on the adjacent band, the level measured around the crossover frequency should go up by 3 dB. Repeat this process for all crossover frequencies.

### 3.3.1 Finding “drop-outs” in the frequency response

Check the entire frequency response of the system. Rooms have quite an impact on the frequency response of speaker systems, due to resonance and various reflections. So, you cannot expect to achieve a linear frequency response right from the start. Use an equalizer such as our ULTRA-CURVE PRO DSP8024 or ULTRA-GRAPH GEQ3102. Look for drop-outs around the crossover frequencies (there should be none, if the output levels have been set properly, as described in paragraph 3.3)!

However, if the frequency response shows some irregularities, it can prove useful to correct it by means of the crossover network, before using an equalizer (EQ). Subsequently, the crossover frequencies must be corrected with an EQ as far as this is possible.

## 3.4 Setting the crossover frequencies

The use of extremely high-grade potentiometers made it unnecessary to install fixed-frequency plug-in modules. Thus, you have a wide range of setting options available that even more expensive crossover networks hardly give you.

The CX3400 works in two specific frequency ranges: 44 though 930 Hz and 440 Hz through 9.3 kHz. The Linkwitz-Riley filters employed in the SUPER-X PRO feature a slope of 24 dB/octave. High-grade components such as 1%-tolerance metal-film resistors ensure a perfect phase and amplitude response at all crossover frequencies.

Please consult the manufacturer’s specifications of the various speaker components to set the crossover frequencies. When polar plots of specific speakers or horns are available, use them too. Don’t set the crossover frequencies around peaks or drop-outs in the frequency response, but try to find a range that is largely linear. When folded woofer horns are used, you also need to take the horn length into account (see chapter 3.5 “Runtime Correction”).

 **Never operate speaker/horn drivers below the frequency range specified by the manufacturer!**

## 3.5 Runtime Correction

### 3.5.1 Background

The ideal transducer would be a point source of sound, i.e. a speaker of infinitely small dimension, which could still reproduce the entire frequency spectrum. Unfortunately, such a sound source is impossible in reality, so that we have to accept some compromises.

If the drivers in a multi-way system (i.e. the diaphragm set in motion by the voice coil, but not e.g. the opening of a horn) are not exactly aligned on a vertical axis, the varying distances between sound source and listener result in phase errors and cancellations (also called “comb filter effect”). In particular, in the high-frequency range it is imperative, due to the shorter wavelengths, that the drivers be positioned one above the other, not side by side. The old-fashioned horizontal rows of radiators follow this principle: while the speaker power is summed up in the horizontal plane, the signals cancel each other on a vertical axis. Thus, unwanted reflections from the ceiling can be reduced.

Consequently, a speaker stack whose systems radiate towards the same area should have all speakers arranged in a vertical line. And even if the front sides of all systems are perfectly aligned, runtime differences still occur due to the different speaker designs (horns, bass reflex cabinet, etc.).

The BEHRINGER SUPER-X PRO allows you to delay the Low bands by up to 2 milliseconds. In this way, you can virtually push back a specific speaker cabinet by as much as 68.6 cm (which is quite useful, for example, when you place a constant-directivity horn (CD) on top of a closed speaker cabinet).

 **Runtime correction is not the same as phase correction. Speaker systems that have the same run times are also in phase (unless, the polarity of one speaker is reversed). However, the opposite is not true.**

### 3.5.2 Basics of electronic runtime correction

It is important to know how the dimensions of time and space are connected with each other, e.g. by using a tape measure and a pocket calculator.

Example: a delay of 2 ms corresponds to a distance of 68.6 cm; when you measure an offset of 30 cm you can calculate the necessary delay as follows:  $2 \text{ ms} \times 30 / 68.6 = 0.87 \text{ ms}$ .

If it is impossible to measure the offset with an accuracy of at least 1 cm, you can perform the runtime correction with the help of a measuring microphone and tunable sine generator, using the SUPER-X PRO's feature of variably adjustable crossover frequencies. More on this below.

The speed of sound is 343 m/s or 34.3 cm/ms approximately (hence, 2 ms of delay correspond to a virtual speaker offset of 68.6 cm). Frequency is measured in oscillations per second (1/s); the unit of measurement is Hertz (Hz).

For example, when you adjust a crossover frequency of 3 kHz between the horn and midrange systems, the wavelength  $\lambda$  is calculated as follows:  $\lambda = c / f$  ( $c$  = speed of sound;  $f$  = frequency). So, the wavelength at 3 kHz is:

$$\frac{34,3 \text{ cm/ms}}{3000 \text{ 1/s}} = \frac{34300 \text{ cm/s}}{3000 \text{ 1/s}} = 11,43 \text{ cm}$$

With a virtual distance of 68.6 cm, the control range of the potentiometer will provide at least six positions that ensure phase coincidence. Perhaps none of these positions will correct the runtime differences completely, for example, if the offset between the drivers is greater than 68.6 cm.

Is that important? It is, because only a system whose runtime differences have been corrected will be capable of:

1. reproducing pulse peaks correctly.
2. maintaining phase coincidence when the signal frequency moves away from the crossover frequency.

### 3.5.3 Runtime correction in a P.A. system using the SUPER-X PRO

#### Midrange/high midrange/tweeter range

Before you perform the following steps to correct both runtime and phase, you should measure the offset between the drivers in cm and move the cabinets (or delay their bands), until you think they are aligned correctly. This will save you a lot of time later on. Now, do the fine adjustment as follows:

#### Using an analyzer

- ▲ Use pink noise as your sound source and connect the measuring microphone to the measuring input of the analyzer.
- ▲ Adjust the bands below/above the crossover frequency so that each one alone produces a 0 dB reading at the crossover frequency; mute the remaining bands. If both bands together produce a +3 dB reading, they can be considered in phase.
- ▲ Now, raise the crossover frequency by a factor of 1.5 and perform the same steps as above. Here, too, the analyzer should read +3 dB.
- ▲ Finally, check your setting by raising the crossover frequency by a factor of 1.4.
- ▲ Here, too, you can temporarily reverse the phase of one of the bands and check the sound for cancellations.

#### If no runtime correction is achieved

- ▲ Check whether the distance between the two drivers is or could be greater than 68.6 cm. If so, try to correct it by moving the speaker cabinets.
- ▲ If this still doesn't solve the problem, one of the bands could be reversed in polarity. Experiment with the front-panel PHASE INVERT button.

#### Subwoofer/woofer/midrange

It is often claimed that phase or runtime correction below 150 Hz is unnecessary, because the sound waves feature a spherical dispersion pattern at such low frequencies. We disagree with this view.

Modern systems often use bass reflex cabinets for their woofer or subwoofer systems. Consequently, when stacking the cabinets, the drivers are usually aligned along the vertical axis of the speaker front, or can at least be aligned using the available control range of the SUPER-X PRO. Here, runtime correction follows the same principle as in midrange/high-midrange/tweeter systems. Problems will be encountered only with unconventional setups (e.g. when the woofers are placed underneath the stage, while the midrange/tweeter systems are flown above it) or when long woofer horns are used. The latter are the subject of the following discussion.

First, measure the horn length. In the case of folded woofer horns this is anything but easy. Use a design drawing or open the cabinet (usually, a flap or cabinet side wall can be opened easily, for instance, to replace a defective speaker).

We use a horn length of 1 m as an example. It will make no sense to delay the signal, because the woofer signal arrives with a 3-ms delay at the “mouth” of the horn. So, you cannot achieve a correct runtime, unless you would delay the runtime of the remaining systems in the stack. The pulse response (the main reason for runtime correction), however, is mainly determined by the mid and tweeter ranges. What you can – and should – achieve though is phase coincidence at the crossover frequency. Which is exactly what the SUPER-X PRO gives you: free adjustability of the crossover frequency.

Calculate the frequency whose wavelength corresponds to twice the horn length. At this frequency the output signal will be reversed by 180° in phase when it comes out from the horn.

The frequency can be calculated as follows:

$$\frac{c}{\lambda} = f \quad (\text{see chapter 3.5.2})$$

Use the known values (speed of sound in m/s; horn length in m) to calculate the frequency:

$$\frac{343 \text{ m/s}}{2 \times 1 \text{ m}} = 171,5 \text{ 1/s} = 171,5 \text{ Hz}$$

Now, using a crossover frequency of 171.5 Hz and reversing the polarity of the woofer output will result in an approximate phase correction, which can be fine-adjusted by applying some delay or shifting the crossover frequency a bit.

#### General remarks on runtime correction

Only one speaker stack each should be measured and corrected. Begin with the highest crossover frequency and work your way downward.

 **Once you have completed the runtime correction procedure, please make a note of the relative positions of the speaker, the adjusted crossover frequencies, delay times, etc. as well as of all level settings (limiters included). The next time you set up your system, you can start from these settings and with a bit of luck you will need to make just a few fine adjustments, before you can turn to the EQs.**

 **Never drive different speakers from the same output! The distances which the sound waves travel before they reach the listener will very likely be different and unavoidably lead to phase shifts. Additionally, the built-in drivers may have different efficiencies, impedance characteristics or even reversed polarities.**

When the speaker offset is greater than 68.6 cm you can only move the speaker cabinets. Runtime correction is not the same as the signal delay applied to offset groups of speakers. Here, the entire signal must be delayed by a much greater amount (a suitable delay circuit is included, for example, in the BEHRINGER ULTRA-CURVE DSP8024).

### 3.6 The limiters of the SUPER-X PRO

Limiting the signal in the crossover network is the last resort to protect the system against overloading. Otherwise, improper handling by the user could lead to serious damage in several drivers.

Each frequency requires its own limiter/compressor control times. The higher the frequency, the shorter the control times. In the SUPER-X PRO, the control times for the single bands have been determined after long listening tests, in order to achieve inaudible gain adaptation instead of hard limiting.



The limiter threshold can be set from -6 dB to OFF and acts on all six limiters at the same time. Still, each limiter band works independently, with the LIM-LEDs lighting up as soon as the associated limiter is activated.

 **Please note that the limiters in the SUPER-X PRO are no “hard ratio” limiters, i.e. signal peaks can surpass the adjusted threshold by as much as 6 dB. Please make sure that your system provides enough headroom.**

### 3.6.1 Limiter setup

On condition that you are using power amps and speakers that are compatible in terms of power rating, you should drive your amps under full load (i.e. 0 dB). Use pink noise from your analyzer as a sound source, turn the limiter THRESHOLD control to maximum and press the LIMITER button. Then, gradually cut back the threshold until just a few LIM-LEDs start flashing. Now, the entire system gain is limited to 0 dB.

## 3.7 LOW SUM function

To produce a very loud and deep bass response, the lowest band should be summed in a mono signal, while the remaining bands remain in stereo (the human ear cannot locate the source of low frequencies). By combining all woofer cabinets in one single cluster (the closer, the better) you can optimize their efficiency. Two woofer cabinets positioned next to each other produce an SPL that is 3 dB higher than that of two cabinets placed at a certain distance. Four cabinet give you as much as 6 dB, because low-frequency sound waves feature a spherical dispersion pattern. When the cabinets are positioned separately, the sound waves they radiate interfere with each other, while cabinets placed next to each other create one common wave front (compare two stones that are thrown into the water, either separately or together).

In stereo mode, the SUPER-X PRO can be switched to mono bass mode using the LOW SUM button.

When the LOW SUM button is pressed, the low-frequency signal portions in the left and right channels are summed up. The output signal is routed to the Low output of channel 1, from where it can be used to drive, for instance, a subwoofer cabinet.

## 3.8 CD HORN function

When a driver radiates into open space via a horn, its efficiency increases. Over the past few years, so-called constant-directivity horns have gained widespread popularity, as they offer the advantage of producing a very regular dispersion pattern over their frequency range; however, the higher the frequency, the lower their efficiency. To make up for this drawback, the SUPER-X PRO includes a switchable pre-EQ for CD horns that ensures a flat frequency response even before equalization is applied. This pre-EQ raises the signal gain by 3 dB at 3.5 kHz, which then increases by 6 dB/oct. up to 22.5 kHz.

# 4. INSTALLATION

Your SUPER-X PRO CX3400 was carefully packed in the factory and the packaging was designed to protect the unit from rough handling. Nevertheless, we recommend that you carefully examine the packaging and its contents for any signs of physical damage, which may have occurred in transit.

 **If the unit is damaged, please do not return it to us, but notify your dealer and the shipping company immediately, otherwise claims for damage or replacement may not be granted. Shipping claims must be made by the consignee.**

## 4.1 Rack mounting

The BEHRINGER SUPER-X PRO fits into one standard 19" rack unit of space. Please allow at least an additional 4" depth for the connectors on the back panel.

Be sure that there is enough air space around the unit for cooling and please do not place the CX3400 on high-temperature devices such as power amps, etc. to avoid overheating.

## 4.2 Mains connection

**Before you connect your SUPER-X PRO to the mains, please make sure that your local voltage matches the voltage required by the unit!** The fuse holder on the female mains connector has 3 triangular markers, with two of these triangles opposing each other. Your CX3400 is set to the operating voltage printed next to these markers, and can be set to another voltage by turning the fuse holder by 180°. **CAUTION: this instruction does not apply to export models exclusively designed, e.g. for 115 V operation!**

The mains connection of the CX3400 is made by using the enclosed mains cable and a standard IEC receptacle. It meets all of the international safety certification requirements.

 **Please make sure that all units have a proper ground connection. For your own safety, never remove or disable the ground conductor of the unit or of the AC power cable.**

## 4.3 Audio connections

As a standard, the BEHRINGER SUPER-X PRO CX3400 is equipped with electronically servo-balanced inputs and outputs. The circuit design features automatic hum and noise reduction for balanced signals and thus allows for trouble-free operation, even at highest operating levels. Externally induced mains hum, etc. will be effectively suppressed. The automatic servo-function recognizes the presence of unbalanced connectors and adjusts the nominal level internally to avoid level differences between the input and output signals (6-dB correction).

 **Please ensure that only qualified persons install and operate the CX3400. During installation and operation the user must have sufficient electrical contact to earth. Electrostatic charges might affect the operation of the SUPER-X PRO.**

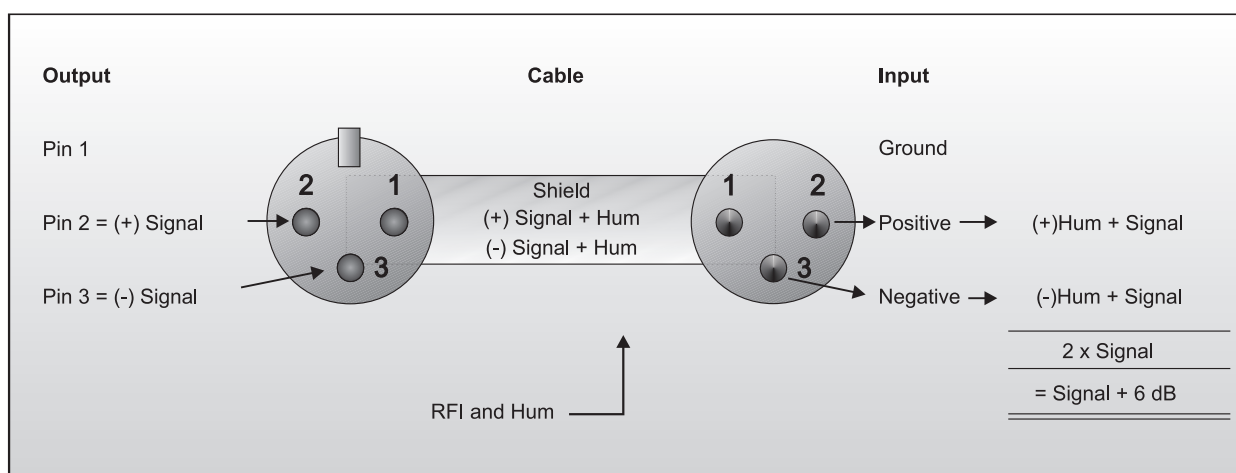

Fig. 4.1: Compensation of interference with balanced connections

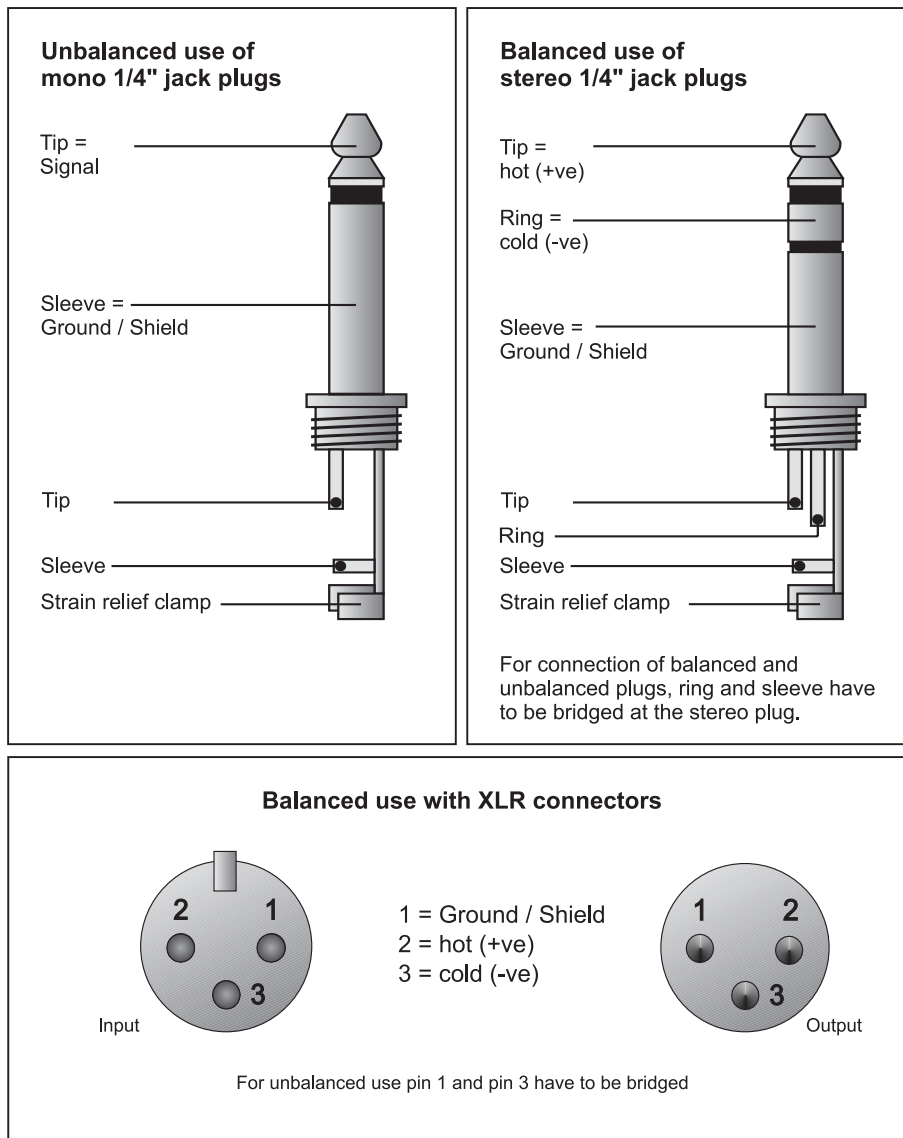

Fig. 4.2: Different plug types

## 5. SPECIFICATIONS

### INPUT

Connectors	XLR
Type	Electronically servo-balanced, RF filtered
Impedance	Balanced >50 kOhms, unbalanced >25 kOhms
Max. Input level	+22 dBu typical, balanced or unbalanced
CMRR	>40 dB, typically >55 dB at 1 kHz

### OUTPUT

Connectors	XLR
Type	Electronically servo-balanced, RF filtered
Impedance	Balanced 60 Ohms, unbalanced 30 Ohms
Max. Output Level	+20 dBm balanced/unbalanced

### PERFORMANCE

Bandwidth	20 Hz to 20 kHz, +0/-0.5 dB	
Frequency Response	<5 Hz to >90 kHz, +0/-3 dB	
Signal to Noise	Ref.: +4 dBu, 20 Hz to 20 kHz, unweighted	
	<b>Stereo Mode:</b>	<b>Mono Mode:</b>
Low Output	>93 dBu	>93 dBu
Low-Mid Output		>94 dBu
Mid Output	>95 dBu	
High-Mid Output		>94 dBu
High Output	>90 dBu	>88 dBu
Dynamic Range	>106 dB, unweighted	

## SUPER-X PRO CX3400

THD & Noise	<b>Limiter Off</b> <0.04%	<b>Limiter On</b> <0.5
Interchannel Crosstalk	High to Low:	<93 dB
	High to Mid:	<94 dBu
	Mid to Low:	<95 dBu
	High to High-Mid:	<95 dBu
	High-Mid to Low-Mid:	<95 dBu
	Low-Mid to Low:	<92 dBu
<b>CROSSOVER</b>		
Filter Type	Linkwitz-Riley, 24 dB/Octave, state-variable	
<b>Stereo Mode Frequencies</b>	<b>x1</b>	<b>x10</b>
Low/High	44 to 930 Hz	440 Hz to 9.3 kHz
Low/Mid	44 to 930 Hz	440 Hz to 9.3 kHz
Mid/High	440 Hz to 9.3 kHz	
<b>Mono Mode Frequencies</b>	<b>x1</b>	<b>x10</b>
Low/Low-Mid	44 to 930 Hz	440 Hz to 9.3 kHz
Low-Mid/High-Mid	440 Hz to 9.3 kHz	
High-Mid/High	440 Hz to 9.3 kHz	
<b>FUNCTION SWITCHES</b>		
<b>Front Panel</b>		
Low Cut	Activates 25 Hz Butterworth, 12 dB/Octave high-pass filter	
Mute	Mutes the individual output	
Phase Invert	Inverts the phase at the individual output	
CD Horn	Corrects CD horn frequency response above 3.5 kHz	
Limiter	Activates the limiter function for all outputs	
<b>Rear Panel</b>		
Xover Frequency	Multiplies crossover frequency range by 10	
Mode	Selects stereo/mono and 2/3/4-way operation	
LF Sum	Selects normal stereo or mono-summed low frequency operation	
	ON=Channel 1 + 6dB louder / Channel 2: the same as before	
<b>CONTROLS</b>		
Input	Controls the input gain (+/-12 dB)	
Xover Frequency	Controls the crossover frequency	
Delay	Controls the delay at the low output (0 to 2 msec.)	
Gain	Controls the output gain (+/-6 dB)	
Threshold	Controls the threshold of the limiter (-6 dB to OFF)	
<b>POWER SUPPLY</b>		
Mains Voltages	USA/Canada	120 V ~, 60 Hz
	U.K./Australia	240 V ~, 50 Hz
	Europe	230 V ~, 50 Hz
	General Export Model	100 - 120 V ~, 200 - 240 V ~, 50 - 60 Hz
	Power Consumption	max. 22 W
Fuse	100-120 V ~: T 630 mA H	
	200-240 V ~: T 315 mA H	
Mains Connection	Standard IEC receptacle	
<b>PHYSICAL</b>		
Dimensions	1 ¾" (44,5 mm) * 19" (482,6 mm) * 8 ½" (217 mm)	
Net Weight	3 kg	
Shipping Weight	4.3 kg	

BEHRINGER is constantly striving to maintain the highest professional standards. As a result of these efforts, modifications may be made from time to time to existing products without prior notice. Specifications and appearance may differ from those listed or illustrated.

## 6. WARRANTY

### § 1 WARRANTY CARD/ONLINE REGISTRATION

To be protected by the extended warranty, the buyer must complete and return the enclosed warranty card within 14 days of the date of purchase to BEHRINGER Spezielle Studiotechnik GmbH, in accordance with the conditions stipulated in § 3. Failure to return the card in due time (date as per postmark) will void any extended warranty claims.

Based on the conditions herein, the buyer may also choose to use the online registration option via the Internet ([www.behringer.com](http://www.behringer.com) or [www.behringer.de](http://www.behringer.de)).

### § 2 WARRANTY

1. BEHRINGER (BEHRINGER Spezielle Studiotechnik GmbH including all BEHRINGER subsidiaries listed on the enclosed page, except BEHRINGER Japan) warrants the mechanical and electronic components of this product to be free of defects in material and workmanship for a period of one (1) year from the original date of purchase, in accordance with the warranty regulations described below. If the product shows any defects within the specified warranty period that are not due to normal wear and tear and/or improper handling by the user, BEHRINGER shall, at its sole discretion, either repair or replace the product.

2. If the warranty claim proves to be justified, the product will be returned to the user freight prepaid.

3. Warranty claims other than those indicated above are expressly excluded.

### § 3 RETURN AUTHORIZATION NUMBER

1. To obtain warranty service, the buyer (or his authorized dealer) must call BEHRINGER (see enclosed list) during normal business hours **BEFORE** returning the product. All inquiries must be accompanied by a description of the problem. BEHRINGER will then issue a return authorization number.

2. Subsequently, the product must be returned in its original shipping carton, together with the return authorization number to the address indicated by BEHRINGER.

3. Shipments without freight prepaid will not be accepted.

### § 4 WARRANTY REGULATIONS

1. Warranty services will be furnished only if the product is accompanied by a copy of the original retail dealer's invoice. Any product deemed eligible for repair or replacement by BEHRINGER under the terms of this warranty will be repaired or replaced within 30 days of receipt of the product at BEHRINGER.

2. If the product needs to be modified or adapted in order to comply with applicable technical or safety standards on a national or local level, in any country which is not the country for which the product was originally developed and manufactured, this modification/adaptation shall not be considered a defect in materials or workmanship. The warranty does not cover any such modification/adaptation, irrespective of whether it was carried out properly or not. Under the terms of this warranty, BEHRINGER shall not be held responsible for any cost resulting from such a modification/adaptation.

3. Free inspections and maintenance/repair work are expressly excluded from this warranty, in particular, if caused by improper handling of the product by the user.

This also applies to defects caused by normal wear and tear, in particular, of faders, potentiometers, keys/buttons and similar parts.

4. Damages/defects caused by the following conditions are not covered by this warranty:

- ▲ misuse, neglect or failure to operate the unit in compliance with the instructions given in BEHRINGER user or service manuals.
- ▲ connection or operation of the unit in any way that does not comply with the technical or safety regulations applicable in the country where the product is used.
- ▲ damages/defects caused by force majeure or any other condition that is beyond the control of BEHRINGER.

5. Any repair or opening of the unit carried out by unauthorized personnel (user included) will void the warranty.

6. If an inspection of the product by BEHRINGER shows that the defect in question is not covered by the warranty, the inspection costs are payable by the customer.

7. Products which do not meet the terms of this warranty will be repaired exclusively at the buyer's expense. BEHRINGER will inform the buyer of any such circumstance. If the buyer fails to submit a written repair order within 6 weeks after notification, BEHRINGER will return the unit C.O.D. with a separate invoice for freight and packing. Such costs will also be invoiced separately when the buyer has sent in a written repair order.

### § 5 WARRANTY TRANSFERABILITY

This warranty is extended exclusively to the original buyer (customer of retail dealer) and is not transferable to anyone who may subsequently purchase this product. No other person (retail dealer, etc.) shall be entitled to give any warranty promise on behalf of BEHRINGER.

### § 6 CLAIM FOR DAMAGES

Failure of BEHRINGER to provide proper warranty service shall not entitle the buyer to claim (consequential) damages. In no event shall the liability of BEHRINGER exceed the invoiced value of the product.

### § 7 OTHER WARRANTY RIGHTS AND NATIONAL LAW

1. This warranty does not exclude or limit the buyer's statutory rights provided by national law, in particular, any such rights against the seller that arise from a legally effective purchase contract.

2. The warranty regulations mentioned herein are applicable unless they constitute an infringement of national warranty law.

---

The information contained in this manual is subject to change without notice. No part of this manual may be reproduced or transmitted in any form or by any means, electronic or mechanical, including photocopying and recording of any kind, for any purpose, without the express written permission of BEHRINGER Spezielle Studiotechnik GmbH.

BEHRINGER, SUPER-X, ULTRA-CURVE and ULTRA-GRAPH are registered trademarks. ALL RIGHTS RESERVED.

© 2000 BEHRINGER Spezielle Studiotechnik GmbH.

BEHRINGER Spezielle Studiotechnik GmbH, Hanns-Martin-Schleyer-Str. 36-38, 47877 Willich-Münchheide II, Germany

Tel. +49 (0) 21 54 / 92 06-0, Fax +49 (0) 21 54 / 92 06-30

---