



ADVANCE 61

User Guide

English

Table of Contents

(Click a chapter/section to skip to it.)

| | |
|---|-----------|
| Introduction | 5 |
| Box Contents | 5 |
| Support | 5 |
| About This User Guide | 5 |
| Initial Setup | 6 |
| 1. Software/Driver Download and Installation | 6 |
| 2. Controller Setup | 6 |
| 3. Software-Controller Configuration | 7 |
| With VIP in Your DAW..... | 7 |
| With VIP in Standalone Mode (Without a DAW) | 8 |
| With Your DAW Only..... | 8 |
| With External MIDI Equipment (Without a Computer) | 8 |
| Features | 9 |
| Top Panel | 9 |
| Rear Panel | 11 |

| | |
|---|-----------|
| Operation | 12 |
| Setup Scenarios | 13 |
| With VIP in Your DAW..... | 13 |
| With VIP in Standalone Mode (Without a DAW) | 13 |
| With Your DAW Only..... | 14 |
| With External MIDI Equipment (Without a Computer) | 14 |
| Display and Navigation | 15 |
| Basic Functions | 16 |
| Loading DAW Presets..... | 16 |
| Loading Patches | 16 |
| Controlling Your Patch or Your DAW | 17 |
| Modes | 18 |
| Main Mode | 18 |
| Selecting the Browser or Setlists | 19 |
| Loading Patches..... | 19 |
| Loading and Saving DAW Presets | 20 |
| Editing Various Global Settings | 21 |
| Setup Mode | 22 |
| Loading and Saving DAW Presets | 22 |
| Editing Various Global Settings | 23 |
| Browser Mode | 24 |
| Selecting Tag Categories..... | 24 |
| Loading Patches..... | 25 |
| Loading Multi Slots | 25 |
| Global Mode | 26 |
| Available Global Settings..... | 26 |
| Control Mode | 28 |
| Selecting Controls | 29 |
| Adjusting Controls | 29 |
| Control Edit Mode..... | 30 |
| Selecting Controls | 30 |
| Editing Control Parameters | 30 |
| Available Control Parameters..... | 31 |

| | |
|---------------------------------------|-----------|
| MIDI Mode | 34 |
| Selecting Controls | 34 |
| Adjusting Controls | 34 |
| MIDI Edit Mode | 35 |
| Selecting Controls | 35 |
| Editing Control Parameters | 35 |
| Available Control Parameters | 36 |
| Multi Mode | 41 |
| About Multis | 41 |
| Creating and Editing Multis | 41 |
| Adjusting Multi Slots | 42 |
| Multi Edit Mode..... | 43 |
| Editing Multi Slot Parameters | 43 |
| Available Multi Slot Parameters | 44 |
| | |
| Timing Functions..... | 45 |
| Overview | 45 |
| Tempo | 45 |
| Tap Tempo | 45 |
| Time Division | 45 |
| Transport Control | 45 |
| Arpeggiator | 46 |
| Note Repeat | 46 |
| | |
| Technical Specifications..... | 47 |
| | |
| Trademarks and Licenses | 47 |

Introduction

Box Contents

Advance 61

USB Cable

Software Installation Card

Quickstart Guide

Safety & Warranty Manual

Support

For the latest information about this product (system requirements, compatibility information, etc.) and product registration, visit akaipro.com.

About This User Guide

This *User Guide* was written to help you get familiar with the Advance 61 hardware.

For consistency and to help prevent confusion, we used a uniform set of symbols to show topics of interest or significance:

Important/Note/Tip: Important or helpful information on a given topic.

Buttons, controls, parameters, and other important items are usually indicated in bold characters.

Examples: Press **Multi**.

Turn the **Data Dial**.

Select the **Mode** field.

Some text refers to other relevant sections, shown in blue, bold italic characters. Click the text to jump to that part of the *User Guide*.

Examples: Make sure your Advance 61 box includes all of the items listed above in ***Box Contents***.

For descriptions of Advance 61's controls, please see the ***Features*** chapter.

To learn how to change an encoder's minimum and maximum value, please see ***Modes > Control Edit Mode***.

Initial Setup

1. Software/Driver Download and Installation

To download and install the required drivers, VIP software application, and virtual instruments:

1. Go to akaipro.com and register your product. If you don't have an Akai Professional account yet, you will be prompted to create one.
2. Download the **Advance Software Package**.
3. Open the file and double-click the installer application: **.exe** (Windows) or **.dmg** (Mac OS X).
4. Follow the on-screen instructions to complete the installation.

Note: By default, VIP will be installed in **[your hard drive] \ Program Files \ VstPlugins** (Windows) or **Applications** (Mac OS X). A shortcut will be created on your Desktop, as well.

To download additional plugins and audio content:

1. Open VIP.
2. In VIP, click **Advance Content**.
3. In the **Advance Content** panel, select and download the plugins and audio content you want to use with VIP. Follow the on-screen instructions for each selection.

Important: When installing these plugins, we recommend installing them on your computer's internal hard drive rather than on an external hard drive.

2. Controller Setup

Here is just an example of how to use Advance 61 to your setup. Items not listed under [Introduction > Box Contents](#) are sold separately.

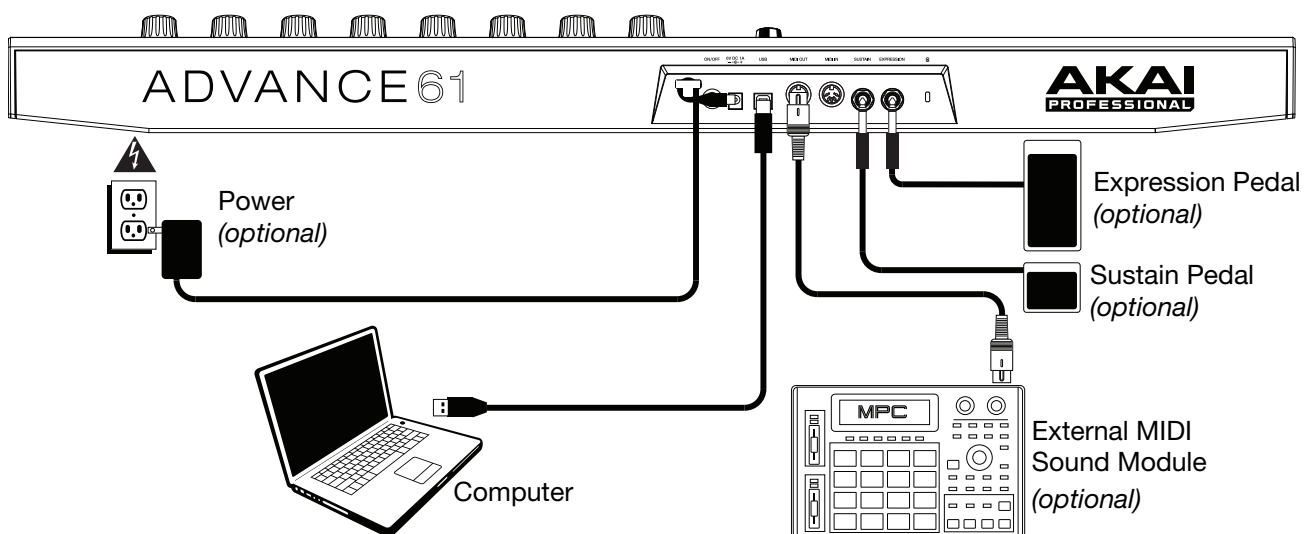

3. Software-Controller Configuration

This section describes how to start using your Advance 61. We recommend using Advance 61 with the included VIP software which you can use to perform with, create, edit, and manage multiple plugin patches simultaneously. To learn more about how you can use Advance 61 in each kind of setup, please see the [Operation](#) chapter.

Make sure you have installed the software (described earlier in [1. Software/Driver Download and Installation](#)) and connected Advance 61 to your computer, external MIDI equipment, and/or other devices (described earlier in [2. Controller Setup](#)).

With VIP in Your DAW

To set up Advance 61 with VIP in your DAW:

1. Power on your Advance 61, and open your DAW in your computer.
2. Make sure **Advance 61** is selected as a controller in your DAW—you can usually do this in your DAW's **Preferences, Device Setup, or Options**.
3. In your DAW, create a new MIDI track (i.e., not an audio track).
4. Open VIP in your DAW as you would open a standard VST plugin. By default, VIP is installed in **[your hard drive]\Program Files\VstPlugins** (Windows) or **Applications** (Mac OS X).
5. In VIP, click the **Settings** menu and select **Plugin Manager**.
6. At the bottom of the **Plugin Manager** window, click one of the **Plugin Folder** fields, and then select the folder where your instrument plugins are located on your computer. You can select up to two locations (one for each **Plugin Folder** field).
7. Click **Scan**. VIP will scan the folder/folders for available plugins, which will appear in the list. When the process is complete, click **OK** to close the Settings window. VIP will return to its main window and begin importing the patches (presets) for all of your scanned plugins. This can take several minutes.
8. On Advance 61, turn the **Data Dial** to browse your list of patches in the **display** (the plug-in name will appear under the patch name). Press the **Data Dial** to load one.

To learn more about how you can use Advance 61 in this kind of setup, please see [Operation > Setup Scenarios > With VIP in Your DAW](#).

With VIP in Standalone Mode (Without a DAW)

To set up Advance 61 with VIP in Standalone Mode:

1. Power on your Advance 61.
2. Open VIP. By default, VIP is installed in **[your hard drive] \ Program Files \ VstPlugins** (Windows) or **Applications** (Mac OS X).
3. In VIP, click the **Settings** menu and select **Plugin Manager**.
4. At the bottom of the **Plugin Manager** window, click one of the **Plugin Folder** fields, and then select the folder where your instrument plugins are located on your computer. You can select up to two locations (one for each **Plugin Folder** field).
5. Click **Scan**. VIP will scan the folder/folders for available plugins, which will appear in the list. When the process is complete, click **OK** to close the Settings window. VIP will return to its main window and begin importing the patches (presets) for all of your scanned plugins. This can take several minutes.
6. On Advance 61, turn the **Data Dial** to browse your list of patches in the **display** (the plug-in name will appear under the patch name). Press the **Data Dial** to load one.

To learn more about how you can use Advance 61 in this kind of setup, please see [Operation > Setup Scenarios > With VIP in Standalone Mode \(Without a DAW\)](#).

With Your DAW Only

To set up Advance 61 with your DAW only:

1. Power on your Advance 61, and open your DAW in your computer.
2. Make sure **Advance 61** is selected as a controller in your DAW—you can usually do this in your DAW's **Preferences**, **Device Setup**, or **Options**.
3. In your DAW, create a new MIDI track (i.e., not an audio track).

To learn more about how you can use Advance 61 in this kind of setup, please see [Operation > Setup Scenarios > With Your DAW Only](#).

With External MIDI Equipment (Without a Computer)

To set up Advance 61 with external MIDI equipment:

1. Power on your Advance 61 and your external MIDI device.
2. If you are using a standard power adapter connected to Advance 61's **Power Input**, you can start playing immediately. Advance 61 is automatically set to send all of its MIDI messages to your external MIDI device via the **MIDI Out**.

If you are using a USB charger to power Advance 61, set any relevant controls to send their MIDI messages out of the **MIDI Out**. Any controls set to transmit only over the **USB Port** will not be sent to your external MIDI device.

To learn more about how you can use Advance 61 in this kind of setup, please see [Operation > Setup Scenarios > With External MIDI Equipment \(Without a Computer\)](#).

Features

Top Panel

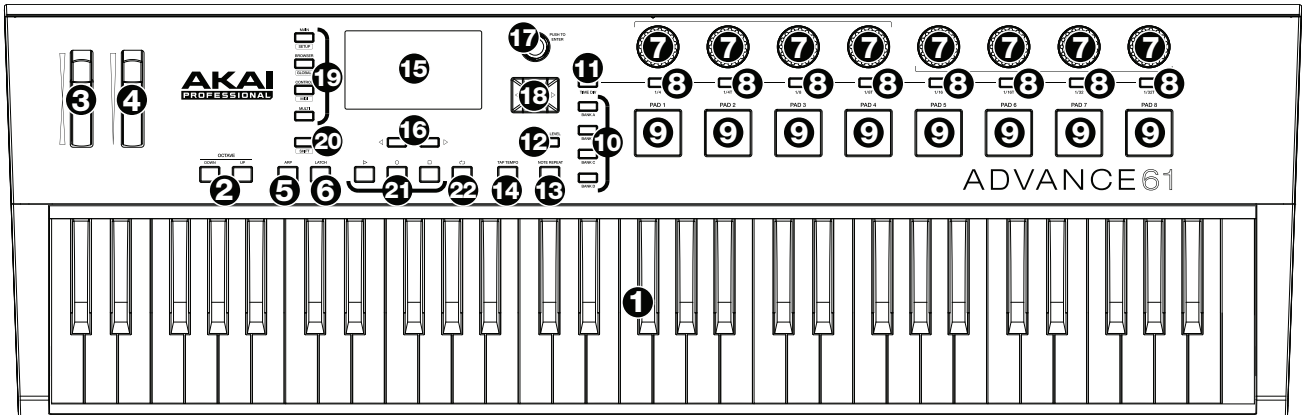

1. **Keyboard:** This 61-note keyboard is velocity- and pressure-sensitive and, in conjunction with the **Octave Up/Down** buttons, can control a 10-octave range.
2. **Octave Down/Up:** Use these buttons to shift the keyboard's range up or down. Press both buttons simultaneously to reset the octave shift to "zero."
3. **Pitch-Bend Wheel:** Moving this wheel sends MIDI Pitch Bend information on a selected MIDI channel and port.
4. **Modulation Wheel:** Moving this wheel sends continuous controller data—MIDI CC #01 (modulation), by default.
5. **Arp / Config:** Press this button to enable or disable the internal Arpeggiator whose rate is based on the current Tempo and Time Division settings. The Arpeggiator will function on notes being played on the **keyboard** only. You can also sync the Arpeggiator to an internal or external MIDI Clock source. Press **Shift** and this button to configure the Arpeggiator's settings.
6. **Latch:** Press this button to activate or deactivate the Arpeggiator's Latch feature. When the Arpeggiator is on and Latch is enabled, you can press a combination of keys on the keyboard and the Arpeggiator continue to arpeggiate these notes even after you release the keys. Pressing a new combination of keys will start a new arpeggiation.

Tip: While holding down a combination of keys on the keyboard, add more notes to that arpeggiated chord by pressing additional keys.
7. **Encoders:** Use these 360° knobs to send MIDI CC or Increment/Decrement messages to your software or external MIDI device.
8. **Switches:** Use these switches to send MIDI CC, Program Change, or Program Bank messages to your software or external MIDI device. They can function as momentary or toggle (latching) switches. If Time Division is activated, these switches select the time division of the Arpeggiator and Note Repeat features.
9. **Pads:** Use these pads to send MIDI Note messages to your software or external MIDI sound module. The pads are pressure- and velocity-sensitive, which makes them very responsive and intuitive to play when triggering drum hits or other samples.
10. **Pad Bank:** Use these buttons to select Pad Bank A, B, C, or D. Between these 4 banks with 8 pads per bank, you can access up to 32 MIDI events.
11. **Time Div:** Use this button and the **switches** to select the current Time Division, which determines the rate of the Note Repeat and Arpeggiator features. While Time Division is active, the switches will not send any of their normal MIDI CC, Program Change, or Program Bank messages.

12. **Full Level:** Press this button to activate or deactivate Full Level. When Full Level is active, the pads always play at their maximum velocity no matter how hard or soft you hit them.
13. **Note Repeat / Config:** Use this button to activate or deactivate Note Repeat. While Note Repeat is active, striking a **pad** causes its note to retrigger at a rate based on the current Tempo and Time Division settings. You can also sync Note Repeat to an internal or external MIDI Clock source. Press **Shift** and this button to configure Note Repeat's settings.
14. **Tap Tempo:** Tap this button at the desired rate to enter a new tempo.
Important: This feature does not work when the Advance 61 is set to **External** sync.
15. **Display:** Use this full-color display to view Advance 61's menus, options, parameters, and settings.
16. **Page Left/Right:** Use these buttons to move between the available pages in the **display**.
17. **Data Dial:** Use this dial to change parameter values, settings, etc. in the **display**. Pressing the dial also functions as an **Enter** button.
18. **Cursors:** Use these buttons to navigate through the menus and options in the current page in the **display**.
19. **Mode Buttons:** Press one of these buttons to enter its primary mode (labeled above the button). Press and hold **Shift** and then press one of these buttons to its secondary mode (labeled under the button). See [Operation > Modes](#) for more information.
20. **Shift:** Press and hold this button to enable secondary functions of certain other buttons on Advance 61.
21. **Transport Control Buttons:** These three buttons are dedicated buttons for sending conventional transport control commands: **Stop**, **Play**, and **Record**. These can be set to send **MIDI** (MIDI Start/Stop), **CC** (pre-assigned MIDI CC values), **MMC** (MIDI Machine Control), and **MMC/MIDI**. The **PTEX** setting is for use with Avid® Pro Tools® Express only.
22. **Loop:** Press and hold this button to activate the Loop or Repeat feature in your software. This button is considered a transport control, so it can be set to send the same messages as the other transport control buttons: **MIDI** (MIDI Start/Stop), **CC** (pre-assigned MIDI CC values), **MMC** (MIDI Machine Control), and **MMC/MIDI**. The **PTEX** setting is for use with Avid® Pro Tools® Express only.

Important: Your software must be able to loop or repeat in order to use this feature. Also, configure the **Transport Format** in Global Mode so it communicates properly with your software.

Rear Panel

1. **Cable Restraint:** You can secure a power adapter cord to this restraint to help avoid disconnecting it accidentally.
2. **Power Button:** Press this button to power the Advance 61 on or off.
3. **Power Input:** Connect this power input to a power outlet using an optional power adapter (6V DC, 1A, center-positive, sold separately). Alternatively, if you want to use Advance 61 to control an external MIDI device and without a computer connection, you can connect Advance 61's **USB Port** to a power outlet using a standard USB charger (sold separately).

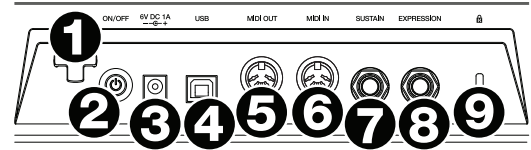

Important: If you use a USB charger to power Advance 61, set any relevant controls to send their MIDI messages out of the **MIDI Out**. Any controls set to transmit only over the **USB Port** will not be sent to a device connected to the **MIDI Out**.

4. **USB Port:** Use a standard USB cable to connect this USB port to your computer. The computer's USB port provides ample power to Advance 61. If you connect it to a USB hub, make sure it is a powered hub. This connection is also used to send and receive MIDI data to and from your computer.

You can also power Advance 61 by connecting this USB port to a power outlet using a standard USB charger (sold separately). If you do this, set any relevant controls to send their MIDI messages out of the **MIDI Out**. Any controls set to transmit only over the **USB Port** will not be sent to a device connected to the **MIDI Out**.

When using Advance 61 with external MIDI equipment:

- If an external device is connected to the **MIDI Out**, your computer can send MIDI messages out along this path: **Computer** ➔ **Advance 61** ➔ **External Device**.
 - If an external device is connected to the **MIDI In**, the external device sends MIDI messages in along this path: **External Device** ➔ **Advance 61** ➔ **Computer**. MIDI messages can then be sent to an external device via the MIDI Out, but they must pass through the computer first.
5. **MIDI Out:** Use a standard five-pin MIDI cable to connect this MIDI Out to the MIDI In of an external MIDI device (e.g., a synthesizer, sequencer, drum machine, etc.). Please see the above **USB Port** description for information about how MIDI messages are routed while using Advance 61.
 6. **MIDI In:** Use a standard five-pin MIDI cable to connect this MIDI In to the MIDI Out of an external MIDI device (e.g., another MIDI controller). The MIDI messages sent to this MIDI In will be sent to your computer via the USB port. Please see the above **USB Port** description for information about how MIDI messages are routed while using Advance 61.
 7. **Sustain Pedal Input:** Connect an optional 1/4" (6.35 mm) TS sustain pedal to this input.
 8. **Expression Pedal Input:** Connect an optional 1/4" (6.35 mm) TRS expression pedal to this input.
 9. **Kensington® Lock Slot:** You may use this Kensington lock slot to secure the Advance 61 to a table or other surface.

Operation

This chapter describes how you can use Advance 61 in your studio or performance setup.

Read [Setup Scenarios](#) to learn how Advance 61 can function with software or hardware (with or without a DAW, with or without VIP, etc.).

Read [Display and Navigation](#) to get a better understanding of Advance 61's full-color display and how to move through its various menus and panels.

Read [Basic Functions](#) to learn how to do some simple tasks with Advance 61.

Read [Modes](#) to learn about each of Advance 61's modes, which let you browse and select your plugins and patches, assign/edit controllers and parameters, adjust global settings, and more.

Read [Timing Functions](#) to see an overview of Advance 61's time-related features. This section also describes how to configure the settings for the Arpeggiator and Note Repeat features.

Setup Scenarios

With VIP in Your DAW

The included VIP software lets you get the most control and function out of your Advance 61. VIP is essentially a host for your plugins, a hub where you can create, edit, and manage your patches (presets) for your various plugins. When VIP is used as a plugin, as in this scenario, all audio from VIP will be sent into your DAW on its track. You can switch between Advance 61's Control Mode to control VIP or MIDI Mode to control your DAW (see the [Modes](#) section for more information).

Tip: You can use Control Edit Mode to assign some knobs to MIDI CC messages instead of VST parameters. This lets you control your plugin *and* your DAW while in Control Mode. See [Modes > Control Edit Mode](#) for more information.

Tip: As with other plugins, you can use multiple instances of VIP in your DAW, each on its own track.

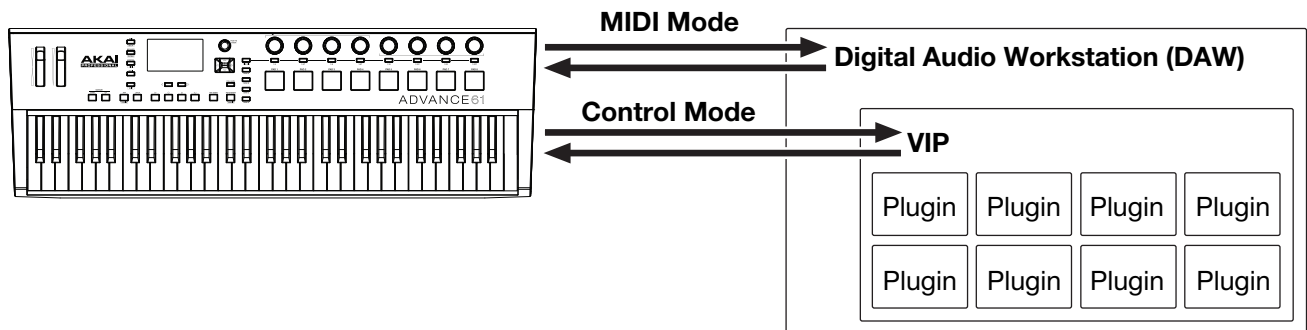

With VIP in Standalone Mode (Without a DAW)

You can use VIP in Standalone Mode without a DAW. This works the same way as when used as a plugin (described [earlier](#)) except the audio is routed to your computer's sound card instead of to your DAW. You can use Advance 61's Control Mode to control VIP (see the [Modes](#) section for more information).

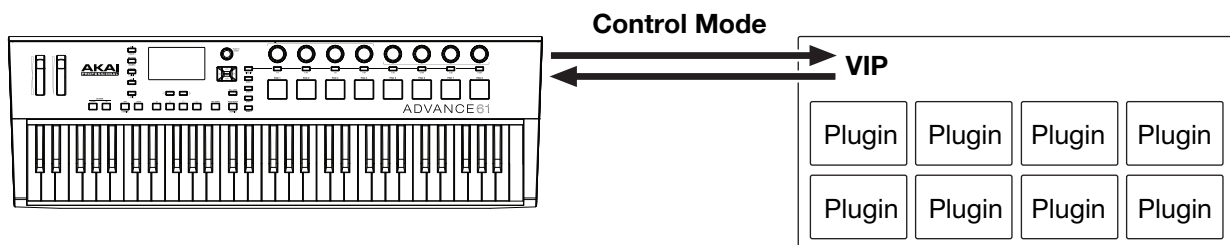

With Your DAW Only

You can use Advance 61 as a standard USB MIDI controller for your music creation software. We've created presets for several popular DAWs so you can use Advance 61 with your projects in the most logical and intuitive way possible. You can use Advance 61's MIDI Mode to control your DAW (see the [Modes](#) section for more information).

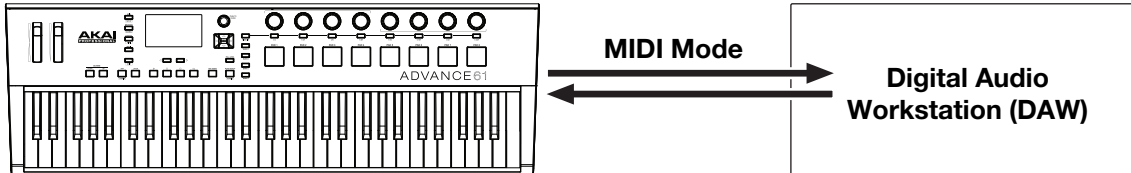

With External MIDI Equipment (Without a Computer)

You can connect an external MIDI device (synth, drum machine, etc.) to Advance 61's **MIDI Out**, letting you use Advance 61 to control it, whether or not you're connected to a computer. If you aren't connected to a computer, though, remember to power Advance 61 externally (see [Features > Rear Panel > Power Input](#)). You can use Advance 61's MIDI Mode to control your external MIDI device (see the [Modes](#) section for more information).

Display and Navigation

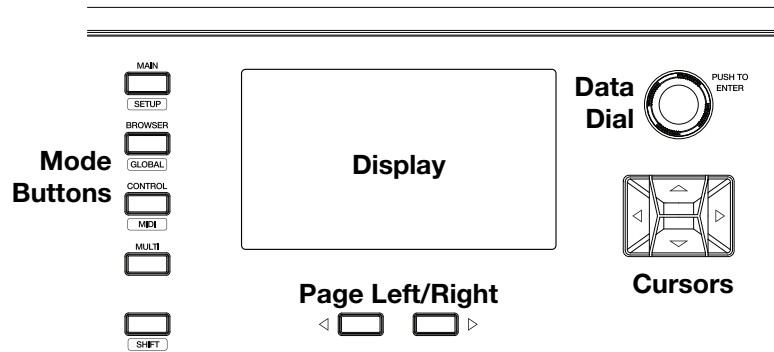

Advance 61's display shows information about its current mode and operations. You can navigate its different modes, pages, etc. by using the following controls:

- **Data Dial:** Use this dial to change a selected parameter values, settings, etc. in the display. Press the dial to enter or confirm a command or setting. You can also use this dial to scroll through lists, menus, and browsers.
- **Cursors:** Use these buttons to navigate through the menus and options in the current page in the display.
- **Page Left/Right:** Use these buttons to move between the available pages in the display. When there is a page available to the left or right of the current one, the corresponding button will light up.
- **Mode Buttons:** Press one of these buttons to enter its primary mode (labeled above the button). Press and hold **Shift** and then press one of these buttons to its secondary mode (labeled under the button).

The display contains the essential information you'll need during performance, recording, or production. When using VIP, though, the VIP software window on your computer may contain additional information, depending on the current mode. Keep this in mind while exploring the different modes in VIP (see the [Modes](#) section for more information).

Basic Functions

Loading DAW Presets

We've pre-mapped several presets that let you use Advance 61 to control your DAW in the most logical and intuitive way possible.

Setup Mode will show a list of presets that let you use Advance 61 to control your DAW. If you are not using VIP, you can see this list in Main Mode, as well.

To load a DAW preset:

1. Press **Shift** and the **Main (Setup)** mode button to enter Setup Mode. If you are not using VIP, you can also press **Main** to enter Main Mode.
2. Use the **Cursor Buttons** to select the DAW Preset Browser (the list of DAW presets in the right half of the display).
3. Turn the **Data Dial** to scroll through the list.
4. Press the **Data Dial** to load a DAW preset. The loaded preset will be highlighted.

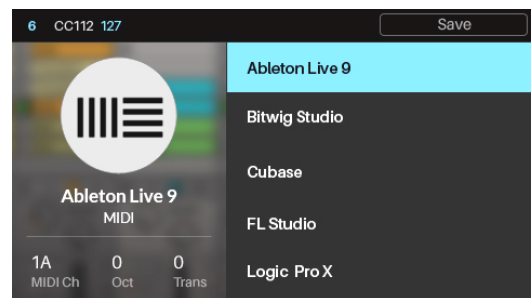

Loading Patches

While using VIP with Advance 61, you can load a patch using the Patch Browser (the right half of the display), which will show all available patches or multis currently in VIP's Patch Browser or in a setlist (described in [Main Mode > Selecting the Browser or Setlists](#)).

To load a patch:

1. Press the **Main** mode button to enter Main Mode.
2. Use the **Cursor Buttons** to select the Patch Browser (the list of patches in the right half of the display).
3. Turn the **Data Dial** to scroll through the list.
4. Press the **Data Dial** to load a patch. The loaded patch will be highlighted.

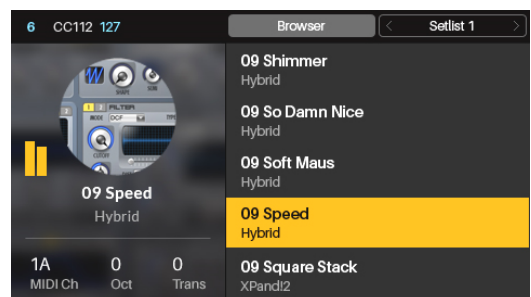

Note: The patches shown in the Patch Browser are based on both the currently selected tags and the text in the **Search** field in VIP (above its own Patch Browser). If you think some patches are missing from the Patch Browser, make sure that **(1)** VIP's **Search** field is empty and **(2)** the correct tags are selected. To learn about tags, see [Browser Mode > Selecting Tag Categories](#).

Controlling Your Patch or Your DAW

Advance 61 has two modes that let you view and control your patch parameters in VIP or functions your DAW: Control Mode and MIDI Mode.

Control Mode shows you the current settings of Advance 61's controls in VIP. Press the **Control** mode button to enter it. You can access this mode only when using VIP.

To adjust the value or change the state of a control, simply turn the **encoder** or press the **switch** or **pad**.

To learn how to edit the parameters of these controls (minimum values, maximum values, CC or note numbers, etc.), see the [Control Edit Mode](#) chapter.

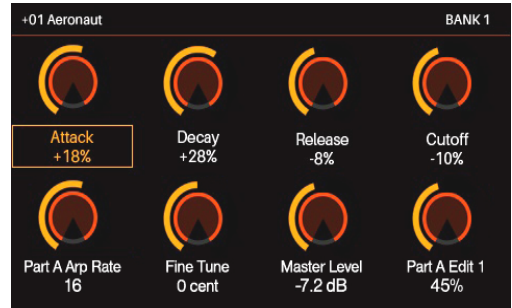

MIDI Mode shows you the current settings of Advance 61's controls when used with your DAW (or an external MIDI device). Press **Shift** and the **Control (MIDI)** mode button to enter it.

To adjust the value or change the state of a control, simply turn the **encoder** or press the **switch** or **pad**. If you're using VIP, you can do this in MIDI Mode (or MIDI Edit Mode) or Setup Mode. If you're not using VIP, you can do this in any mode.

To learn how to edit the parameters of these controls (minimum values, maximum values, CC or note numbers, etc.), see the [MIDI Edit Mode](#) chapter.

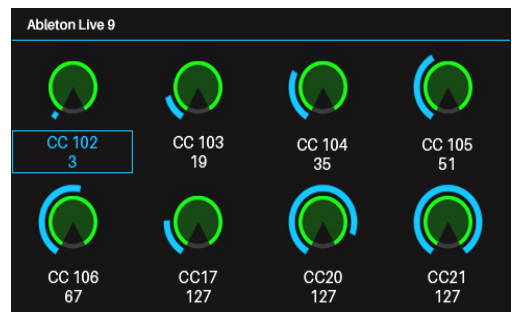

Modes

Advance 61 has ten different modes of operation. Enter each mode by pressing its corresponding mode button (or **Shift** and the button, if it is a secondary button command). Note that a mode's appearance may depend on whether or not you are using the VIP software.

Click a link below to jump to the description of that mode:

[Main Mode](#)

[Control Mode](#)

[Multi Mode](#)

[Setup Mode](#)

[Control Edit Mode](#)

[Multi Edit Mode](#)

[Browser Mode](#)

[MIDI Mode](#)

[Global Mode](#)

[MIDI Edit Mode](#)

Main Mode

When using Advance 61 with VIP, Main Mode shows a list of the available patches for your plugins in VIP.

To navigate this mode:

- Use the **Cursors** to move between different fields and tabs. You can change some global settings in this mode (MIDI channel (**MIDI Ch**), octave (**Oct**), and transposition (**Trans**)), as well.
- Use the **Data Dial** to move through the list of patches or to change a value or setting.

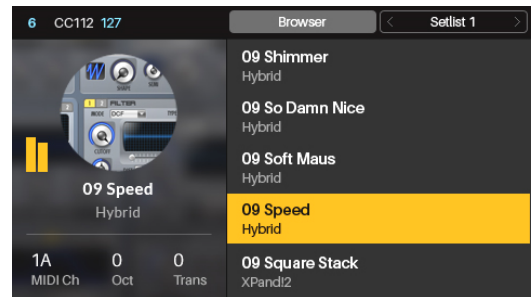

When Advance 61 without VIP, Main Mode shows a list of available presets that let you use Advance 61 to control your DAW. This is the same as in [Setup Mode](#).

Note: When using Advance 61 with VIP, press **Shift** and the **Main (Setup)** mode button to access this Setup Mode.

To navigate this mode:

- Use the **Cursors** to move between different fields and tabs. You can change some global settings in this mode (MIDI channel (**MIDI Ch**), octave (**Oct**), and transposition (**Trans**)), as well.
- Use the **Data Dial** to move through the list of patches or to change a value or setting.

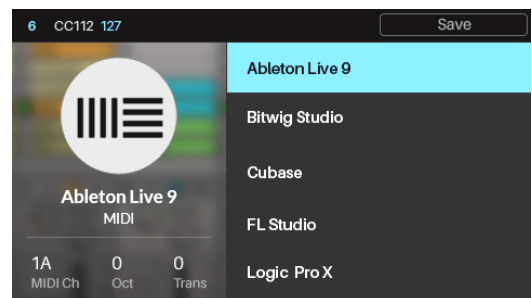

See the following sections to learn more about using Main Mode.

Selecting the Browser or Setlists

While using VIP with Advance 61, the Patch Browser (the right half of the display) will show the patches and multis that are **(A)** currently in VIP's Patch Browser or **(B)** in a setlist. The currently selected one will be shaded grey in the upper-right part of the display.

To select the Browser:

1. Use the **Cursor Buttons** to select **Browser** (at the top of the display).
2. Press the **Data Dial**. The patches and multis shown in VIP's Patch Browser will appear below.

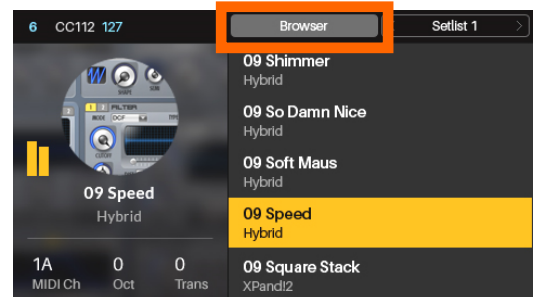

To select a setlist:

1. Use the **Cursor Buttons** to select the field in the upper-right corner of the display (a setlist's name).
2. Turn the **Data Dial** to select the desired setlist.
3. Press the **Data Dial**. The patches and multis in that setlist will appear below.

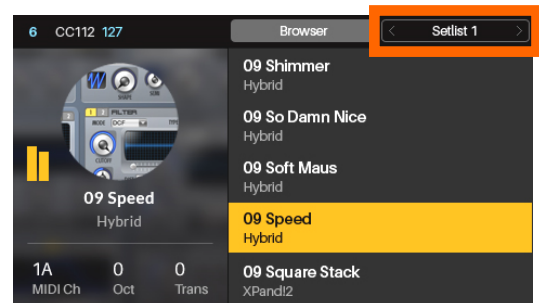

Loading Patches

While using VIP with Advance 61, you can load a patch using the Patch Browser (the right half of the display), which will show all available patches or multis currently in VIP's Patch Browser or in a setlist (described [earlier](#)).

To load a patch:

1. Make sure you have selected either the **Browser** or the setlist with the patch you want.
2. Use the **Cursor Buttons** to select the Patch Browser (the list of patches in the right half of the display).
3. Turn the **Data Dial** to scroll through the list.
4. Press the **Data Dial** to load a patch. The loaded patch will be highlighted.

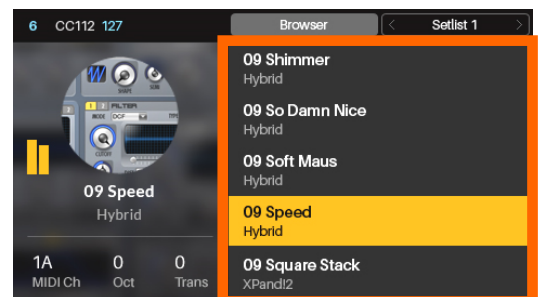

Note: The patches shown in the Patch Browser are based on both the currently selected tags and the text in the **Search** field in VIP (above its own Patch Browser). If you think some patches are missing from the Patch Browser, make sure that **(1)** VIP's **Search** field is empty and **(2)** the correct tags are selected. To learn about tags, see [Browser Mode > Selecting Tag Categories](#).

Loading and Saving DAW Presets

If you are not using VIP, Main Mode will show a list of presets that let you use Advance 61 to control your DAW. We've pre-mapped each so you can use Advance 61 to control your DAW in the most logical and intuitive way possible.

To load a DAW preset:

1. Use the **Cursor Buttons** to select the DAW Preset Browser (the list of DAW presets in the right half of the display).
2. Turn the **Data Dial** to scroll through the list.
3. Press the **Data Dial** to load a DAW preset. The loaded preset will be highlighted.

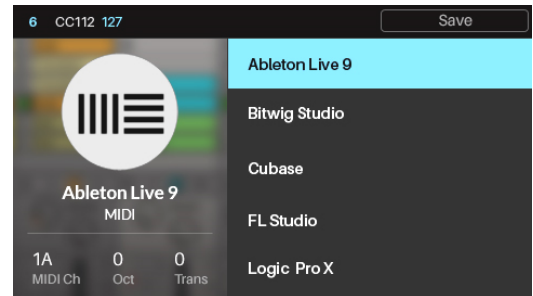

You can also save DAW presets with your own custom MIDI mappings (made in [MIDI Edit Mode](#)). You can save over an existing DAW preset or one of the user presets (**User Preset Default ##**).

To save a DAW preset:

1. With the desired DAW preset already selected, use the **Cursor Buttons** to select **Save** in the upper-right corner of the display.
2. Press the **Data Dial**. The preset's name in the left half of the display will be highlighted.
3. Enter a new name for the preset by using the following controls:
 - To move to the previous or next character, press the **Left Cursor** or **Right Cursor**, respectively.
 - To add a new character, press the **Right Cursor** at the end of the name.
 - To add a space, press the **Up Cursor**.
 - To change the current character, turn the **Data Dial**.
 - To delete the current character, press the **Down Cursor**.
4. Press the **Data Dial**. The preset is now saved.

Editing Various Global Settings

Whether or not you are using VIP, you can change some of Advance 61's global settings in Main Mode.

To adjust global settings in Main Mode:

- Use the **Cursor Buttons** to select any of the three fields in the lower-left corner of the display:
 - MIDI Ch:** Advance 61 will send its messages over this MIDI channel. This is the same as the **Common Channel** setting in *Global Mode*.
 - Oct:** Advance 61's keyboard will be offset by this many octaves. This is the same as the **Octave** setting in *Global Mode* or using the **Octave Down/Up** buttons.
 - Trans:** Advance 61's keyboard will be transposed by this many semitones. This is the same as the **Transpose** setting in *Global Mode*.
- Turn the **Data Dial** to change the setting. The setting will be updated immediately.

Press the **Data Dial** to return the setting to its default.

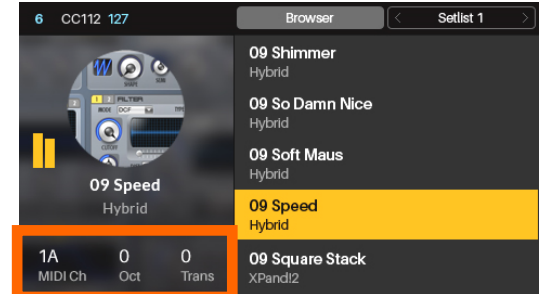

Setup Mode

Setup Mode shows a list of available presets that let you use Advance 61 to control your DAW. We've pre-mapped each so you can use Advance 61 to control your DAW in the most logical and intuitive way possible.

To navigate this mode:

- Use the **Cursors** to move between different fields and tabs. You can change some global settings in this mode (MIDI channel (**MIDI Ch**), octave (**Oct**), and transposition (**Trans**)), as well.
- Use the **Data Dial** to change a value or setting.

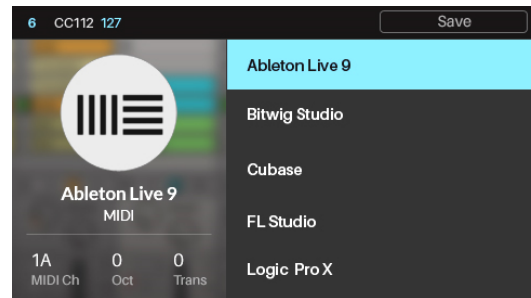

See the following sections to learn more about using Setup Mode.

Loading and Saving DAW Presets

Setup Mode will show a list of presets that let you use Advance 61 to control your DAW. We've pre-mapped each so you can use Advance 61 to control your DAW in the most logical and intuitive way possible.

To load a DAW preset:

1. Use the **Cursor Buttons** to select the DAW Preset Browser (the list of DAW presets in the right half of the display).
2. Turn the **Data Dial** to scroll through the list.
3. Press the **Data Dial** to load a DAW preset. The loaded preset will be highlighted.

You can also save DAW presets with your own custom MIDI mappings (made in [MIDI Edit Mode](#)). You can do save over an existing DAW preset or one of the user presets (**User Preset Default ##**).

To save a DAW preset:

1. With the desired DAW preset already selected, use the **Cursor Buttons** to select **Save** in the upper-right corner of the display.
2. Press the **Data Dial**. The preset's name in the left half of the display will be highlighted.
3. Enter a new name for the preset by using the following controls:
 - To move to the previous or next character, press the **Left Cursor** or **Right Cursor**, respectively.
 - To add a new character, press the **Right Cursor** at the end of the name.
 - To add a space, press the **Up Cursor**.
 - To change the current character, turn the **Data Dial**.
 - To delete the current character, press the **Down Cursor**.
4. Press the **Data Dial**. The preset is now saved.

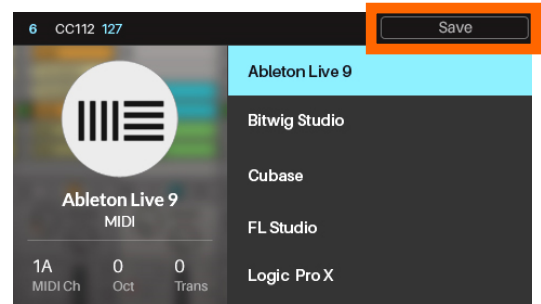

Editing Various Global Settings

Whether or not you are using VIP, you can change some of Advance 61's global settings in Setup Mode.

To adjust global settings in Main Mode:

1. Use the **Cursor Buttons** to select any of the three fields in the lower-right corner of the display:
 - **MIDI Ch:** Advance 61 will send its messages over this MIDI channel. This is the same as the **Common Channel** setting in [Global Mode](#).
 - **Oct:** Advance 61's keyboard will be offset by this many octaves. This is the same as the **Octave** setting in [Global Mode](#) or using the **Octave Down/Up** buttons.
 - **Trans:** Advance 61's keyboard will be transposed by this many semitones. This is the same as the **Transpose** setting in [Global Mode](#).
2. Turn the **Data Dial** to change the setting. The setting will be updated immediately.

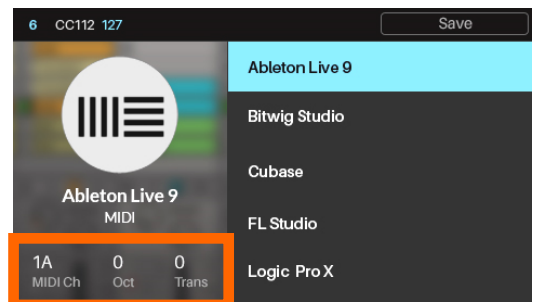

Press the **Data Dial** to return the setting to its default.

Browser Mode

Browser Mode lets you browse and select patches of your plugins. You can access this mode only when using VIP.

To navigate this mode:

- Use the **Cursors** to move between different fields and tabs.
- Use the **Data Dial** to scroll through the different lists.
- Use the **Page Left/Right** buttons to view each category tag (**Plugin**, **Instruments**, **Style**, etc).

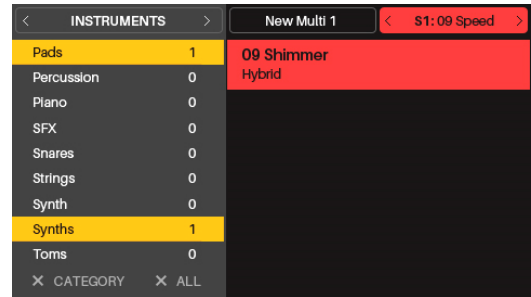

See the following sections to learn more about using Browser Mode.

Selecting Tag Categories

In VIP, each of your patches can be associated with various “tags” in different categories. This feature lets you easily sort and filter your numerous patches based on **Plugin** name, **Expansion** name, **Instruments**, **Timbres**, **Styles**, and/or **Articulations**.

A patch can be tagged with one or more tags from each category. For example, a synth pad might be tagged with multiple **Timbres**: **Airy**, **Clean**, **Pure**, and **Waves**. The exceptions are the **Plugin** and **Expansion** categories; a patch will have only one **Plugin** tag and (if it belongs to an Expansion) only one **Expansion** tag.

When using tags to filter your patches, you can select one or multiple tags from one or multiple categories. For example, to view all of your bass patches, you could select just the **Bass** tag in the **Instrument** category. To narrow your search results, you could also select **Distorted** and **Noise** from the **Timbres** category as well as **Dance** and **Dub** from the **Styles** category.

To select tags (to filter your patches):

1. Use the **Page Left/Right** buttons to view each tag category (**Plugin**, **Instruments**, **Style**, etc). Alternatively, use the **Cursor Buttons** to select the field in the upper-left corner of the display, and then turn the **Data Dial**.
2. Use the **Cursor Buttons** to select the Tag Browser (the list of tags in the left half of the display).
3. Turn the **Data Dial** to scroll through the list of tags in that category.
4. Press the **Data Dial** to select or deselect a tag. A selected tag will be highlighted and any patches with that tag will appear in the Patch Browser in the right half of the display.



To select additional tags, repeat **Steps 1–4** (for tags in a different category) or **Steps 3–4** (for tags in the same category).

Note: The patches shown in the Patch Browser are based on both the currently selected tags and the text in the **Search** field in VIP (above its own Patch Browser). If you think some patches are missing from the Patch Browser, make sure that **(1)** VIP’s **Search** field is empty and **(2)** the correct tags are selected.

To deselect all tags in the currently shown category, use the **Cursor Buttons** to select **X Category** (in the lower-left corner of the display), and then press the **Data Dial**.

To deselect all tags, use the **Cursor Buttons** to select **X All** (in the lower-left corner of the display), and then press the **Data Dial**.

Loading Patches

Browser Mode also lets you load a patch using the Patch Browser (the right half of the display), which will show all available patches or multis currently in VIP's Patch Browser.

To load a patch:

1. Use the **Cursor Buttons** to select the Patch Browser (the list of patches in the right half of the display).
2. Turn the **Data Dial** to scroll through the list.
3. Press the **Data Dial** to load a patch. The loaded patch will be highlighted.

Note: The patches shown in the Patch Browser are based on both the currently selected tags and the text in the **Search** field in VIP (above its own Patch Browser). If you think some patches are missing from the Patch Browser, make sure that **(1)** VIP's **Search** field is empty and **(2)** the correct tags are selected.

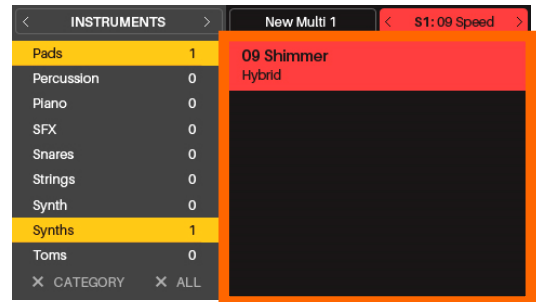

Loading Multi Slots

Browser Mode also lets you load different patches to slots in a multi. When you have selected a multi slot, you can then use Browser Mode to select a patch and then load it to that multi slot.

Learn more about how multis work in the [Multi Mode](#) chapter.

To load a patch to a multi slot:

1. Use the **Cursors** to move to the **Slot** tab in the upper-right corner (**S#**). The number indicates the currently selected slot of the multi.
2. Turn the **Data Dial** to select the desired slot (**S1–S8**) and then press the **Data Dial**.
3. Use the **Data Dial** and **Cursors** to select and load a patch (described [earlier](#)). That patch will then be loaded to the slot of the multi. Repeat these steps to load patches to other multi slots.

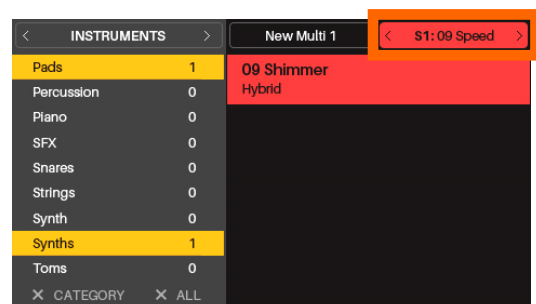

Global Mode

Global Mode lets you set parameters and make changes to Advance 61's general ("global") settings that are not specific to a preset.

To navigate this mode:

- Use the **Page Left/Right** buttons to view each page of settings.
- Use the **Cursors** to select the setting you want to edit.
- Use the **Data Dial** to change a value or setting.

Important: To retain your new settings for future sessions, save them. To do this, use the **Page Right** button to move to the right-most page, select **Save Global Settings**, and press the **Data Dial**. Without saving, the settings will return to their default settings once you power off your Advance 61.

| GLOBAL | | 1 |
|-------------------|--|------|
| Common Channel | | A1 |
| Note Display Type | | Name |
| Screen Contrast | | 10 |
| Transport Format | | MIDI |
| Octave | | 0 |
| Trans | | 0 |

Available Global Settings

Below is a list of available global parameters.

| | |
|---------------------------|---|
| Common Channel | Advance 61 will send its messages over this MIDI channel. This is the same as the MIDI Ch setting in Main Mode or Setup Mode. You can select any one of Channels A1–16 or B1–16 . The letter of the port (A or B) is relevant for USB MIDI only; the 5-pin MIDI Out will ignore the port letter. |
| Note Display Type | This determines whether Advance 61's display will show notes as a Name (e.g., C1 , F#2 , etc.) or a Number (e.g., 36 , 66 , etc.). |
| Screen Brightness | This determines the brightness of Advance 61's display. The available range is 1–10 . |
| Transport Format | This determines what type of transport control command Advance 61's transport buttons (Play , Rec , and Stop) send. These can be set to send MIDI (MIDI Start/Stop), CC (pre-assigned MIDI CC values), MMC (MIDI Machine Control), and MMC/MIDI . When set to PTEX , transport control messages will be sent only on USB Port B, Channel 16, regardless of the Common Channel setting. This setting is for use with Avid® Pro Tools® Express only. |
| Octave | Advance 61's keyboard will be offset by this many octaves. This is the same as the changing the Oct setting in in Main Mode or Setup Mode or using the Octave Down/Up buttons. The available range is -4 to +4 . 0 indicates the center (no offset). |
| Transpose | Advance 61's keyboard will be transposed by this many semitones. This is the same as the Trans setting in Main Mode or Setup Mode. The available range is -36 to +36 . 0 indicates the center (no transposition). |
| Keybed Curve | This is the velocity curve of Advance 61's keyboard . The available settings are Linear , Exp1 (exponential), and Exp2 (exponential). |
| Keybed Sensitivity | This is the overall velocity sensitivity of Advance 61's keyboard . The available range is 1–10 . At 1 , it would take a lot of force to generate the maximum velocity value of 127. At 10 , it is fairly easy to generate a maximum-velocity note. |

| | |
|-----------------------------|---|
| Pad Threshold | This is the velocity threshold to trigger Advance 61's pads . This setting can help prevent false triggering or make it easier to trigger the pads. The available range is 0–15 . |
| Pad Curve | This is the velocity curve of Advance 61's pads . The available settings are Linear , Exp1 (exponential), Exp2 (exponential), Log1 (logarithmic), and Log2 (logarithmic). |
| Pad Sensitivity | This is the overall velocity sensitivity of Advance 61's pads . The available range is 1–10 . At 1 , it would take a lot of force to generate the maximum velocity value of 127. At 10 , it is fairly easy to generate a maximum-velocity note. |
| Internal Tempo | This is the global tempo in beats per minute (BPM). When Advance 61 is using its internal MIDI clock (see Clock Source below), this setting also determines the speed of the Note Repeat feature and Arpeggiator. The available range is 30–300 BPM. |
| Tap Average | This is the number of times you would need to press Tap Tempo for Advance 61 to detect and enter a new tempo. The available range is 2–4 . |
| Tempo LED | When Advance 61 is using its internal MIDI clock (see Clock Source below), the Tap Tempo light will flash in time with the current tempo setting. You can turn this feature On or Off . |
| Clock Source | This determines whether Advance 61 uses its Internal MIDI clock or refers to an External clock (e.g., from a DAW). |
| Save Global Settings | If this setting is selected and its field says Push to save , you can press the Data Dial to store your global settings. Once the field reads No changes , the global settings are stored in Advance 61's internal memory. |
| Send Program | If this setting is selected, you can press the Data Dial to send all of Advance 61's current controller settings (encoder positions, switch states, etc.) to your computer connected to the USB Port or to an external MIDI device connected to the MIDI Out . |
| Firmware Version | This is Advance 61's current firmware version. |
| Boot ROM | This is Advance 61's current read-only memory version. |
| Factory Reset | If this setting is selected, you can press the Data Dial to restore Advance 61's factory/default settings. Your Advance 61 will immediately power off and on again with restored default global settings. |

Control Mode

Control Mode shows you the current settings of Advance 61's controls in VIP. You can access this mode only when using VIP.

Orange/yellow controls are assigned to parameters in VIP. Green/aqua controls are assigned to MIDI CC messages, which are sent to your DAW.

To navigate this mode:

- Press the **Control** mode button to view each set of controls (**encoders, switches, and pads**).
- Use the **Page Left/Right** buttons to view each bank of that control type.
- Use the **Cursors** to select a control. Alternatively, turn or press a control to select it directly.
- Press the **Data Dial** to enter Control Edit Mode.

Note: By default, all knobs in this mode will be assigned to parameters in VIP. To assign a knob to your DAW instead, use [Control Edit Mode](#).

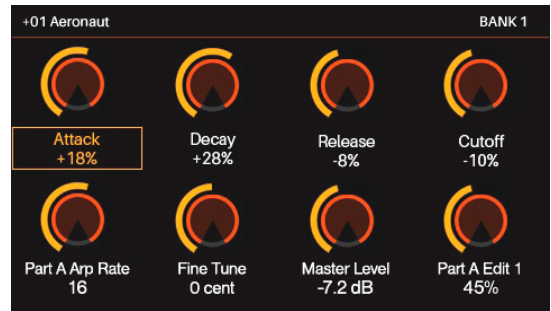

Although Control Mode is preassigned to control VIP (orange/yellow controls), it's important to understand that you can edit these assignments so that you can control both VIP (with orange/yellow controls) **and** your DAW (with green/aqua controls) in Control Mode. In contrast, MIDI Mode lets you control your DAW only.

You could therefore configure Control Mode in any of the following ways:

- to control VIP only (the **display** will show only orange/yellow controls)
- to control both VIP and your DAW (the **display** will show a combination of orange/yellow and green/aqua controls)
- to control your DAW only (the **display** will show only green/aqua controls; effectively, this would act as an additional MIDI Mode)

To learn how to edit your control assignments and parameters, see [Control Edit Mode](#).



See the following sections to learn more about using Control Mode.

Selecting Controls

In Control Mode, you can select a control **(A)** to view its settings or **(B)** to edit it in Control Edit Mode.

To select a control:

1. Select the type of control by pressing the **Control** mode button. Each time you press it, the display will show the next type of control: **encoders**, **switches**, and **pads**.
2. Use the **Page Left/Right** buttons to select the desired bank of that control type. For pads, you can alternatively use the **Pad Bank** buttons.
3. To select the desired control, do either of the following:
 - Turn the desired **encoder** or press the desired **switch** or **pad**. (The control will send its MIDI message when you do this.)
 - Use the **Cursors** to select the desired encoder, switch, or pad in the display. (Use this option if you do not want the control to send its MIDI message.)
4. To adjust the value or change the state of a control, simply turn the **encoder** or press the **switch** or **pad**. You can do this in Control Mode (or Control Edit Mode) or Main Mode.

To edit the selected control's parameters, press the **Data Dial**. See [Control Edit Mode](#) to learn more about editing its parameters.

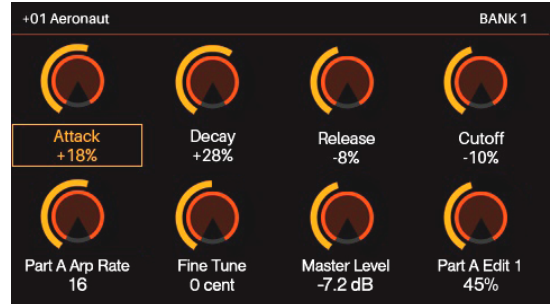

Adjusting Controls

To adjust the value or change the state of a control, simply turn the **encoder** or press the **switch** or **pad**. You can do this in Control Mode (or Control Edit Mode) or Main Mode.

Control Edit Mode

Control Edit Mode lets you edit the parameters of your controls (minimum values, maximum values, CC or note numbers, etc.) for the current patch in VIP. You can access this mode only when using VIP.

Orange/yellow controls are assigned to parameters in VIP. Green/aqua controls are assigned to MIDI CC messages, which are sent to your DAW.

Because VIP lets you control multiple patches, make sure you have selected the one you want before making adjustments in this mode.

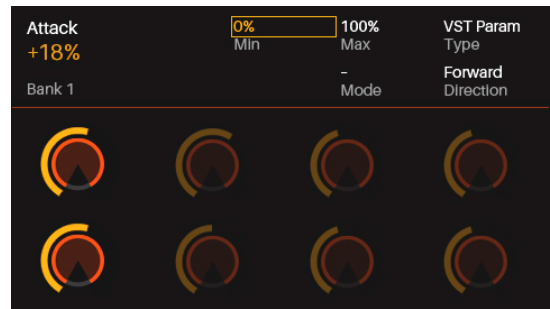

To navigate this mode:

- Press the **Control** mode button to view each set of controls (**encoders, switches, and pads**).
- Use the **Page Left/Right** buttons to view each bank of that control type.
- Use the **Cursors** to select the parameter you want to edit.
- Turn the **Data Dial** to change a value or setting.
- Press the **Data Dial** to return to the normal Control Mode (described [earlier](#)).

See the following sections to learn more about using Control Edit Mode.

Selecting Controls

You can select a control to edit in one of two ways:

- Select it in Control Mode as described [earlier](#), and then press the **Data Dial**. The display will immediately show the control and its parameters.
- Simply turn the **encoder** or press the **switch** or **pad**. The display will immediately show the control and its parameters. Use the **Page Left/Right** buttons at any time to select that control in another bank.

Editing Control Parameters

To edit a control's parameters, use the **Cursors** to select the desired parameter, and then turn the **Data Dial** to change its value or setting. The new value or setting will take effect immediately; you do not need to confirm your choice or exit Control Edit Mode.

You can continue to edit other parameters for this control, or you can select another control to edit its parameters instead.

To exit Control Edit Mode and return to the normal Control Mode, press the **Data Dial**.

Available Control Parameters

Below is a list of available parameters for each type of control.

Encoders



- Type** This determines whether the encoder controls a parameter for a plugin in VIP (**VST Param**; the encoders will be orange/yellow) or sends a **MIDI CC** message to your DAW (the encoders will be green/aqua).
- Parameter or CC** (upper-left field) When **Type** is set to **VST Param**, this is the parameter for a VST plugin in VIP that is controlled by the encoder. When **Type** is set to **MIDI CC**, this is the MIDI CC number for a parameter in your DAW that the encoder controls.
- Min / Max** These determine the lowest (**Min**) and highest (**Max**) values. The available range is **0%–100%**.
- Mode** This determines whether the encoder’s operation is normal (**Default**) or **Bipolar**:
- **Default:** The encoder’s minimum position corresponds to **0**.
 - **Bipolar:** The encoder’s 12 o’clock position corresponds to **0**, while turning it clockwise from that position will set the parameter to positive values, and turning it counterclockwise will set it to negative values.
- Important:** These **Mode** operations will be reversed if **Invert** is set to **On**.
- Invert** This determines whether the encoder’s polarity is normal (**Off**) or inverted (**On**).

Switches

| | |
|---|--|
| Type | This determines whether the switch controls a parameter for a plugin in VIP (VST Param) or sends a MIDI CC message to your DAW. |
| Parameter or CC (upper-left field) | When Type is set to VST Param , this is the parameter for a plugin in VIP that is controlled by the switch. When Type is set to MIDI CC , this is the MIDI CC number for a parameter in your DAW that the switch controls. |
| Min / Max | These determine the lowest (Min) and highest (Max) values. The available range is 0%–100% . |
| Mode | This determines whether the switch’s operation is Toggle , Momentary , or Step : <ul style="list-style-type: none"> • Toggle: Each time you press the switch, it will turn on or off and remain in that state until you press it again. • Momentary: The switch will be on for as long as you are holding it down. It will turn off when you release it. • Step: The full range of the switch’s parameter (minimum value to maximum value) will be divided into a number of “steps.” Each time you press the switch, the value will increase by one step. Once it’s at the maximum value, press the switch once more to reset it to the minimum value. <p>For example, if the parameter’s range is 0% to 100% and the range is divided into 20 steps, pressing the switch each time will increase the value by 5% (Step 1/20). When the value is at 100% (Step 20/20), pressing the switch once will return it to 0% (Step 0/20).</p> <p>Important: These Mode operations will be reversed if Invert is set to On.</p> |
| Steps | When Mode is set to Step , this determines the total number of steps. The available range is 2–200 . |
| Invert | This determines whether the switch’s polarity is normal (Off) or inverted (On). |

Pads

Important:

In VIP, the pads' parameters are global. In other words, the pads' MIDI note and channel assignments are not associated with a specific plugin or patch.

The pads' colors will change depending on what bank is currently selected.

Note

This is the MIDI note that the pad will send when you press it.

Tip: You can set whether this appears as a **Name** (e.g., **C1**, **F#2**, etc.) or a **Number** (e.g., **36**, **66**, etc.) in *Global Mode*.

MIDI Ch

This is the MIDI channel over which the pad will send its MIDI note when you press it. You can select any one of Channels **1–16**.

MIDI Mode

MIDI Mode shows you the current settings of Advance 61's controls when used with your DAW.

To navigate this mode:

- Press **Shift** and the **Control (MIDI)** mode button to view each set of controls (**encoders**, **switches**, and **pads**).
- When viewing the **pads**, use the **Page Left/Right** buttons to view each pad bank.
- Use the **Cursors** to select a control. Alternatively, turn or press a control to select it directly.
- Press the **Data Dial** to enter MIDI Edit Mode.

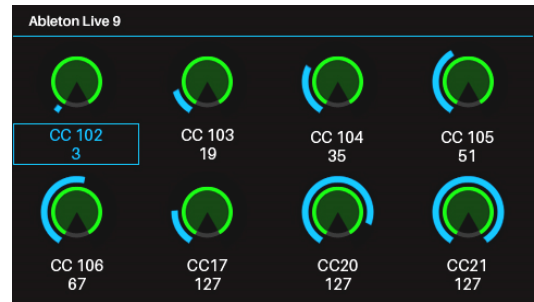

See the following sections to learn more about using MIDI Mode.

Selecting Controls

In MIDI Mode, you can select a control **(A)** to view its settings or **(B)** to edit it in MIDI Edit Mode.

To select a control:

1. Select the type of control by pressing **Shift** and the **Control (MIDI)** mode button. Each time you press them, the display will show the next type of control: **encoders**, **switches**, and **pads**.
2. If you are viewing the pads, use the **Page Left/Right** buttons or **Pad Bank** buttons to select the desired bank.
3. To select the desired control, do either of the following:
 - Turn the desired **encoder** or press the desired **switch** or **pad**. (The control will send its MIDI message when you do this.)
 - Use the **Cursors** to select the desired encoder, switch, or pad in the display. (Use this option if you do not want the control to send its MIDI message.)

To adjust the value or change the state of a control, simply turn the **encoder** or press the **switch** or **pad**. If you're using VIP, you can do this in MIDI Mode (or MIDI Edit Mode) or Setup Mode. If you're not using VIP, you can do this in any mode.

To edit the selected control's parameters, press the **Data Dial**. See [MIDI Edit Mode](#) to learn more about editing its parameters.

Adjusting Controls

To adjust the value or change the state of a control, simply turn the **encoder** or press the **switch** or **pad**. If you're using VIP, you can do this in MIDI Mode (or MIDI Edit Mode) or Setup Mode. If you're not using VIP, you can do this in any mode.

MIDI Edit Mode

MIDI Edit Mode lets you edit the parameters of your controls (minimum values, maximum values, CC or note numbers, etc.) when used with your DAW or external MIDI device.

To navigate this mode:

- Press **Shift** and the **Control (MIDI)** mode button to view each set of controls (**encoders, switches, pads, footswitch, expression pedal, modulation wheel, and pitch-bend wheel**).
- When viewing the **pads**, use the **Page Left/Right** buttons or **Pad Bank** buttons to select another bank.
- Use the **Cursors** to select the parameter you want to edit. Alternatively, turn or press a control to select it directly.
- Turn the **Data Dial** to change a value or setting.
- Press the **Data Dial** when viewing an **encoder, switch, or pad** page to return to the normal MIDI Mode (described [earlier](#)).



See the following sections to learn more about using MIDI Edit Mode.

Selecting Controls

You can select a control to edit in a few different ways:

- **To edit an encoder, switch, or pad**, select it in MIDI Mode as described [earlier](#), and then press the **Data Dial**. The display will immediately show the control and its parameters.
If you are already editing an **encoder, switch, or pad**, and want to edit another control of the same type, simply turn or press it. The display will immediately show the control and its parameters. For pads, use the **Page Left/Right** buttons or **Pad Bank** buttons at any time to select another bank.
- **To edit the footswitch, expression pedal, modulation wheel, or pitch-bend wheel**, make sure you are already in MIDI Edit Mode, and then press **Shift** and the **Control (MIDI)** mode button to cycle through all available controls. These additional controls will appear in the display after the **pads**.

Editing Control Parameters

To edit a control's parameters, use the **Cursors** to select the desired parameter, and then turn the **Data Dial** to change its value or setting. The new value or setting will take effect immediately; you do not need to confirm your choice or exit MIDI Edit Mode.

You can continue to edit other parameters for this control, or you can select another control to edit its parameters instead.

To exit MIDI Edit Mode and return to the normal MIDI Mode, press the **Data Dial**.

Available Control Parameters

Below is a list of available parameters for each type of control.

Encoders

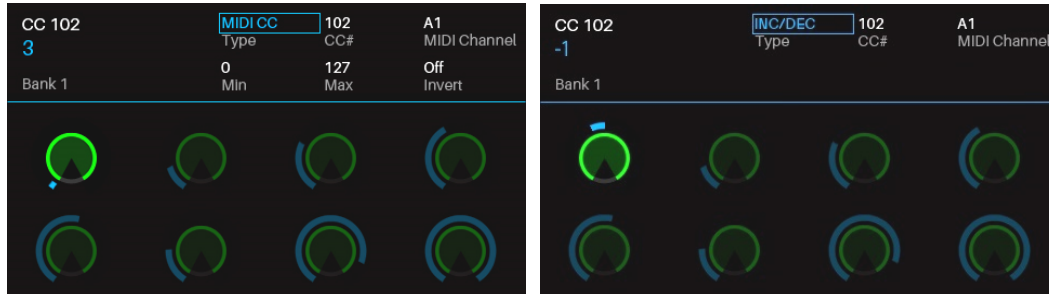

- Type** This determines whether the encoder sends a **MIDI CC** message or an increment/decrement message (**Inc/Dec**).
- CC#** When **Type** is set to **MIDI CC**, this is the MIDI CC number that the encoder controls. The available range is **0–127**.
- MIDI Channel** This is the MIDI channel over which the encoder will send its MIDI message when you turn it. You can select the Common Channel (**Common:##**) or any one of Channels **A1–16** or **B1–16**.
- Min / Max** When **Type** is set to **MIDI CC**, these determine the lowest (**Min**) and highest (**Max**) values. The available range is **0–127**.
- Invert** When **Type** is set to **MIDI CC**, this determines whether the encoder’s polarity is normal (**Off**) or inverted (**On**).

Switches

| | |
|---------------------|---|
| Type | This determines whether the switch sends a MIDI CC message, Program Change message (Program Chn), or Program Bank message. |
| CC# | When Type is set to CC , this is the MIDI CC number that the switch controls. The available range is 0–127 . |
| Program | When Type is set to Program Chn or Program Bank , this is the Program number that the switch sends. |
| MIDI Channel | This is the MIDI channel over which the switch will send its MIDI message when you press it. You can select the Common Channel (Common:##) or any one of Channels A1–16 or B1–16 . |
| Mode | When Type is set to CC , this determines whether the switch's operation is Toggle or Momentary : <ul style="list-style-type: none">• Toggle: Each time you press the switch, it will turn on or off and remain in that state until you press it again.• Momentary: The switch will be on for as long as you are holding it down. It will turn off when you release it. This operation will be reversed if Invert is set to On. |
| Invert | When Type is set to CC and Mode is set to Momentary , this determines whether the switch's polarity is normal (Off) or inverted (On). |
| MSB / LSB | When Type is set to Program Bank , these determine the Most Significant Bit (MSB) and Least Significant Bit (LSB) messages. The available range is 0–127 . |

Pads

Important: Remember that you can use the **Page Left/Right** buttons or the **Pad Bank** buttons to select the desired bank, which is shown in the upper-left corner of the display.

| | |
|-----------------------------|--|
| Note | This is the MIDI note that the pad will send when you press it. Tip: You can set whether this appears as a Name (e.g., C1 , F#2 , etc.) or a Number (e.g., 36 , 66 , etc.) in Global Mode . |
| MIDI Channel | This is the MIDI channel over which the pad will send its MIDI note when you press it. You can select the Common Channel (Common:##) or any one of Channels A1–16 or B1–16 . |
| Aftertouch | If Mode is set to Momentary , this is the type of aftertouch messages the pad will send after the initial press (if you hold it down). <ul style="list-style-type: none"> • Off: The pad will not send aftertouch messages. • Channel Aftertouch (Chn): The pad will send channel pressure messages. • Poly Aftertouch: The pad will send key aftertouch messages. |
| Mode | This determines whether the pad's operation is Toggle or Momentary : <ul style="list-style-type: none"> • Toggle: Each time you press the pad, it will turn on or off and remain in that state until you press it again. • Momentary: The pad will be on for as long as you are holding it down. It will turn off when you release it. |
| On Color / Off Color | These determine each pad's color when pressed/on and when not pressed/off. The available colors for each setting are: Off (no light), Red , Orange , Amber , Yellow , Green , Green/Blue , Aqua , Light Blue , Blue , Purple , Pink , Hot Pink , LtPurple (Light Purple), LtGreen (Light Green), LtPink (Light Pink), and Grey . You can press and release the pads while selecting your colors to test how they look. Tip: Select contrasting colors for a pad's on and off states to easily see your presses. You could also select different sets of colors for each pad bank to easily determine which bank is selected. |

Footswitch

| | |
|---------------------|--|
| Type | This is the type of message that the footswitch will send when you press it. The footswitch can send a Sustain message, send a MIDI CC message, or act as a switch for Tap Tempo , Play , Record , Stop , Play/Stop , or Arp On/Off . |
| Mode | When Type is set to Sustain or MIDI CC , this determines whether the footswitch's operation is Toggle or Momentary : <ul style="list-style-type: none">• Toggle: Each time you press the footswitch, it will turn on or off and remain in that state until you press it again.• Momentary: The footswitch will be on for as long as you are holding it down. It will turn off when you release it. |
| MIDI Channel | When Type is set to Sustain or MIDI CC , this is the MIDI channel over which the footswitch will send its MIDI note when you press it. You can select the Common Channel (Common:##) or any one of Channels A1-16 or B1-16 . |

Expression Pedal

| | |
|---------------------|--|
| MIDI Channel | This is the MIDI channel over which the expression pedal will send its MIDI message when you turn it. You can select the Common Channel (Common:##) or any one of Channels A1-16 or B1-16 . |
| CC# | When Type is set to MIDI CC , this is the MIDI CC number that the expression pedal controls. The available range is 0-127 . |
| Min / Max | When Type is set to MIDI CC , these determine the lowest (Min) and highest (Max) values. The available range is 0-127 . |
| Invert | When Type is set to MIDI CC , this determines whether the expression pedal's polarity is normal (Off) or inverted (On). |

Modulation Wheel

- MIDI Channel** This is the MIDI channel over which the modulation wheel will send its MIDI message when you turn it. You can select the Common Channel (**Common:##**) or any one of Channels **A1–16** or **B1–16**.
- CC#** When **Type** is set to **MIDI CC**, this is the MIDI CC number that the modulation wheel controls. The available range is **0–127**.
- Min / Max** When **Type** is set to **MIDI CC**, these determine the lowest (**Min**) and highest (**Max**) values. The available range is **0–127**.
- Invert** When **Type** is set to **MIDI CC**, this determines whether the modulation wheel's polarity is normal (**Off**) or inverted (**On**).

Pitch Wheel

- MIDI Channel** This is the MIDI channel over which the pitch-bend wheel will send its MIDI message when you turn it. You can select the Common Channel (**Common:##**) or any one of Channels **A1–16** or **B1–16**.

Multi Mode

About Multis

Multi Mode lets you use your Advance 61 to control a multi in VIP. A **multi** is collection of 2–8 patches (from 1 or more plugins). Each patch is assigned to a slot, and each slot has an assigned color. When using a multi, you can simultaneously control volume, panning, solos, and mutes for each slot in a mixer-style interface. You can do this only when using VIP.

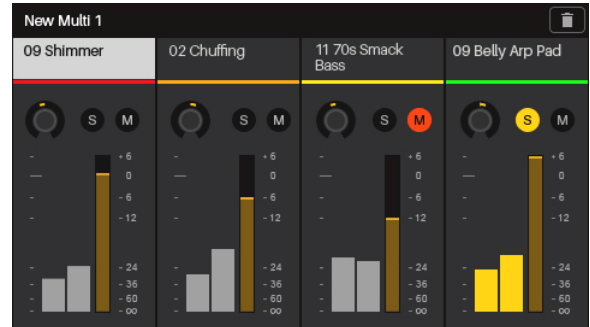

To navigate this mode:

- Use the **Page Left/Right** buttons to switch between each view of 4 slots.
- Use the **Cursors** to select a slot.
- Press the **Data Dial** to enter Multi Edit Mode.

See the following sections to learn more about using Multi Mode.

Creating and Editing Multis

To create and load patches to a multi:

Note: You need to exit Multi Mode to load patches to a multi.

1. Press **Browser** to enter Browser Mode.
2. Use the **Cursors** to move to the **Slot** tab in the upper-right corner (**S#**). The number indicates the currently selected slot of the multi.
3. Turn the **Data Dial** to select the desired slot (**S1–S8**) and then press the **Data Dial**.
4. Use the **Data Dial** and **Cursors** as you would in Browser Mode (described in [Browser Mode > Loading Patches](#)) to select and load a patch. That patch will then be loaded to the slot of the multi. Repeat Steps 2–4 to add more patches.
5. Press **Multi** to return to Multi Mode.

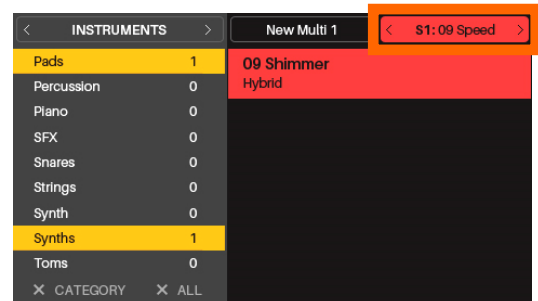

To clear patches from a multi:

1. In Multi Mode, use the **Left/Right Cursors** to select the patch you want to clear from the multi.
2. Press the **Up Cursor** to select **Clear Slot** in the upper-right corner.
3. Press the **Data Dial** to clear the slot.

To clear patches from other multi slots, repeat these steps.

Adjusting Multi Slots

Use the following Advance 61 controls to adjust the volume, panning, solos, and mutes for each slot in a multi. The 8 slots correspond to the 8 **encoders**, **switches**, and **pads**.

- **To solo a slot**, press its **switch**. The **S** button will light up in the display and its pad will flash. Any unsoloed slots' pad lights will turn off.
- **To mute a slot**, press its **pad**. The **M** button will light up in the display, and its pad light will turn off.
- **To adjust the volume of a slot**, turn its **encoder**. The meter will move in the display.
- **To adjust the panning of a slot**, press **Shift** and turn its **encoder**. The panning knob will move in the display.
- **To switch between each view of 4 slots**, use the **Page Left/Right** buttons. Note that you are always controlling **all 8 slots** in Multi Mode, regardless of which 4 slots you are viewing.

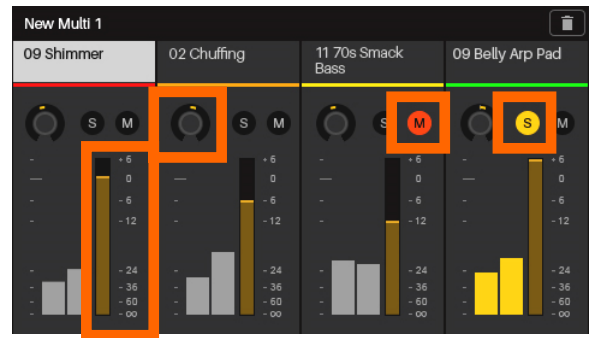

Important: You can still make normal Multi Mode adjustments to all 8 slots even while you are in Multi Edit Mode. Not all of the parameters will be shown in the **display**, but they are visible in VIP (and when you return to the normal Multi Mode).

Multi Edit Mode

Multi Edit Mode lets you edit the various settings of each slot when using Advance 61 (keyboard range, transposition, MIDI channel, and mute or solo status).

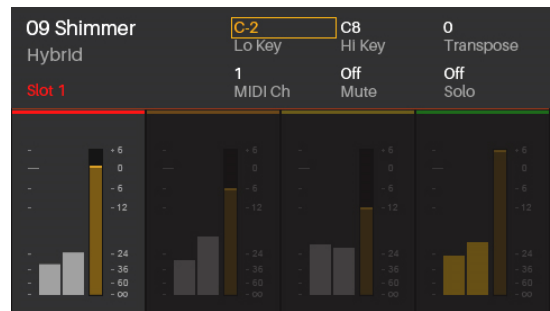

To navigate this mode:

- Use the **Cursors** to select the parameter you want to edit.
- Use the **Data Dial** to change a value or setting.
- Press the **Multi** mode button or **Data Dial** to return to the normal Multi Mode (described [earlier](#)).

See the following sections to learn more about using Multi Edit Mode.

Editing Multi Slot Parameters

To edit a multi slot's parameters:

1. Use the **Left/Right Cursors** to select the desired multi slot. To move between each view of 4 slots, use the **Page Left/Right** buttons.
2. Press the **Data Dial**. The display will immediately show the control and its parameters.
3. To edit a multi slot's parameters, use the **Cursors** to select the desired parameter, and then turn the **Data Dial** to change its value or setting. The new value or setting will take effect immediately; you do not need to confirm your choice or exit Multi Edit Mode.
4. To exit Multi Edit Mode and return to the normal Multi Mode, press the **Multi** mode button or **Data Dial**.

Important: You can still make normal Multi Mode adjustments to all 8 slots even while you are in Multi Edit Mode. Not all of the parameters will be shown in the **display**, but they are visible in VIP (and when you return to the normal Multi Mode).

Available Multi Slot Parameters

Below is a list of available parameters for each multi slot.

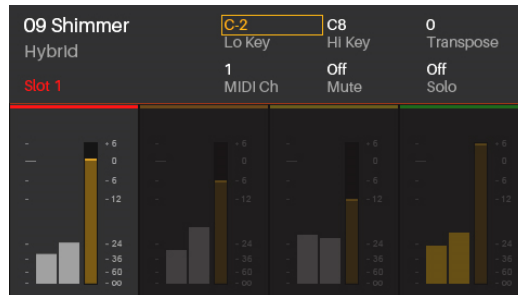

Lo Key / Hi Key These fields indicate (respectively) the lowest and highest incoming MIDI notes that the slot will use to play its patch. The slot will ignore any incoming notes outside of this range.

Tip: This is also useful for playing multiple patches simultaneously. Set certain slots' regions so they overlap others, causing multiple patches to play at the same time, creating new sounds and tonalities. This also is useful for creating different regions on your Advance 61 to play specific patches only. For instance, you could assign 5 non-overlapping, 2-octave regions of the keyboard to play 5 different patches.

Transpose The multi slot will be transposed by this many semitones up or down. The available range is **-36** to **+36**. **0** indicates the center (no transposition). This is useful if you want to offset the pitches that are available to you on your Advance 61's pads.

MIDI Ch This is the MIDI channel over which the multi slot will send its MIDI message when you play its patch. You can select **All** channels or any one of Channels **1–16**.

Mute This is the slot's current mute status. When this is **On**, the slot is muted.

Solo This is the slot's current solo status. When this is **On**, all other slots are muted. You can solo multiple slots simultaneously.

Timing Functions

Overview

Between your VIP, your DAW, and/or an external MIDI device, your Advance 61 will be working within a setup that requires a MIDI clock source. Here are some things to keep in mind when **(1)** selecting the MIDI clock source and **(2)** adjusting/editing any timing-related settings in your setup.

Tempo

External MIDI Clock Source: To use your DAW or external MIDI device as your MIDI clock source, set Advance 61's **Clock Source** (in [Global Mode](#)) to **External**. Similarly, set the MIDI clock source in your DAW or external MIDI device to send its clock information out. Advance 61's Tap Tempo button will be disabled and its light will remain off when using an external clock source.

Internal MIDI Clock Source: To use Advance 61 as your MIDI clock source, set its **Clock Source** (in [Global Mode](#)) to **Internal**. Similarly, set your DAW and/or external MIDI device to receive clock information from Advance 61.

You can set Advance 61's internal tempo in either of the following ways:

- Tap the **Tap Tempo** button at the desired rate.
- Adjust the **Internal Tempo** setting in Global Mode.

The tempo of the MIDI clock source affects Advance 61's [Arpeggiator](#) and [Note Repeat](#) features.

Tap Tempo

When Advance 61's **Clock Source** (in [Global Mode](#)) is set to **Internal**, its **Tap Tempo** button will flash at rate the current tempo. The button will be disabled and its light will remain off when Advance 61's **Clock Source** is set to **External**.

You can use Global Mode to customize the Tap Tempo button's operation. Use **Tap Average** to set the number of times you would need to press **Tap Tempo** for Advance 61 to detect and enter a new tempo. Use **Tempo LED** to turn the button's light **On** or **Off**.

You can also set a connected **footswitch** to act as the Tap Tempo button. See [MIDI Edit Mode](#) to learn how to do this.

Time Division

Advance 61's time division setting determines how each beat is divided. The setting is a subdivision of the tempo: **1/4**, **1/4T**, **1/8**, **1/8T**, **1/16**, **1/16T**, **1/32**, and **1/32T** (T denotes a triplet-based time division). This feature works whether Advance 61's **Clock Source** is set to **Internal** or **External**.

You can set the time division by pressing **Time Div** and pressing one of the 8 **switches**. Alternatively, set the **Time Division** parameter in the configuration pages for the [Arpeggiator](#) or [Note Repeat](#).

Transport Control

The four **Transport Control** buttons are dedicated buttons for sending conventional transport control commands: **Stop**, **Play**, **Record**, and **Loop** (if your software supports this feature). You can use the **Transport Format** setting (in [Global Mode](#)) to set these buttons to send **MIDI** (MIDI Start/Stop), **CC** (pre-assigned MIDI CC values), **MMC** (MIDI Machine Control), and **MMC/MIDI**. The **PTEX** setting is for use with Avid® Pro Tools® Express only: transport control messages will be sent only on USB Port B, Channel 16, regardless of the **Common Channel** setting.

Important: Your software must be able to loop or repeat in order to use the **Loop** button. Also, configure the **Transport Format** in Global Mode so it communicates properly with your software.

Arpeggiator

Advance 61's Arpeggiator separates chords whose rate is based on the current tempo and time division settings. The Arpeggiator will function on notes being played on the **keyboard** only. You can sync the Arpeggiator to an internal or external MIDI clock source.

To edit the Arpeggiator's parameters, press and hold **Shift** and then press **Arp**. The Arpeggiator's parameters will appear in the **display**.

| | |
|-----------------|--|
| Type | This is the type of arpeggio a played chord will produce when the Arpeggiator is on. There are over 100 unique arpeggios to choose from. |
| Range | This is the total range of the arpeggio in octaves. The available range is 0-3 . The direction depends on the Type . |
| Swing | This is the amount of swing used in the notes of the arpeggio. The available range is 50%-75% . |
| Time Div | This is the Arpeggiator's speed shown as a division of the master tempo or external clock. The available options are 1/4, 1/4T, 1/8, 1/8T, 1/16, 1/16T, 1/32, and 1/32T . (T denotes a triplet-based time division.) Tip: Alternatively, press Time Div so it is lit, and then press one of the 8 switches to select the time division shown underneath each of them. |
| Note Len | This is the length of the arpeggiated notes. The available range is 1%-50% of the current time division setting. (Depending on the currently loaded patch/patches, adjustments to this setting may not have an obvious effect.) |

Note Repeat

While Advance 61's Note Repeat feature is active, striking a **pad** causes its note to retrigger at a rate based on the current tempo and time division settings. You can sync Note Repeat to an internal or external MIDI Clock source.

To edit Note Repeat's parameters, press and hold **Shift** and then press **Note Repeat**.

| | |
|-----------------|--|
| Swing | This is the amount of swing used in the repeated notes. The available range is 50%-75% . |
| Time Div | This is the speed of the repeated notes shown as a division of the master tempo or external clock. The available options are 1/4, 1/4T, 1/8, 1/8T, 1/16, 1/16T, 1/32, and 1/32T . (T denotes a triplet-based time division.) Tip: Alternatively, press Time Div so it is lit, and then press one of the 8 switches to select the time division shown underneath each of them. |

Technical Specifications

| | |
|---|--|
| Keyboard | 61 velocity- and pressure-sensitive keys 10 -octave range with Octave Down/Up buttons Pitch-bend wheel Modulation wheel |
| Encoders | 8 360° assignable encoders 1 360° encoder with push function for display navigation |
| Pads | 8 velocity- and pressure-sensitive pads; multicolor-backlit |
| Switches | 8 assignable switches; amber-backlit 23 function switches; amber-backlit 4 directional cursor buttons |
| Display | 3.75" x 2.125" (95.3 mm x 54 mm) full-color LCD |
| Connections | 1 1/4" (6.35 mm) TRS expression pedal input 1 1/4" (6.35 mm) TS sustain pedal input 1 5-pin MIDI input 1 5-pin MIDI output 1 USB port 1 power adapter input |
| Power | 6 V DC, 1 A, center-positive |
| Dimensions (width x depth x height) | 36.0" x 11.5" x 3.5" 91.4 cm x 29.2 cm x 8.9 cm |
| Weight | 12.1 lbs. 5.5 kg |

Specifications are subject to change without notice.

Trademarks and Licenses

Akai Professional is a trademark of inMusic Brands, Inc., registered in the U.S. and other countries.

Portions of the Advance 61 software are Copyright ©2014 The FreeType Project (freetype.org). All rights reserved.

Avid and Pro Tools are trademarks or registered trademarks of Avid Technology, Inc. in the U.S. and other countries. Pro Tools Express ©2012 Avid Technology, Inc. All rights reserved.

Kensington and the K & Lock logo are registered trademarks of ACCO Brands.

Mac and OS X are trademarks of Apple Inc., registered in the U.S. and other countries.

Windows is a registered trademark of Microsoft Corporation in the United States and other countries.

VST is a trademark of Steinberg Media Technologies GmbH.

All other product or company names are trademarks or registered trademarks of their respective owners.

