



MUSIC SYNTHESIZER

S90XS

S70XS

Owner's Manual

SPECIAL MESSAGE SECTION

PRODUCT SAFETY MARKINGS: Yamaha electronic products may have either labels similar to the graphics shown below or molded/stamped facsimiles of these graphics on the enclosure. The explanation of these graphics appears on this page. Please observe all cautions indicated on this page and those indicated in the safety instruction section.

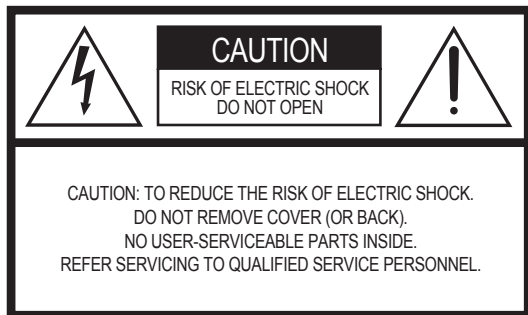

The exclamation point within the equilateral triangle is intended to alert the user to the presence of important operating and maintenance (servicing) instructions in the literature accompanying the product.

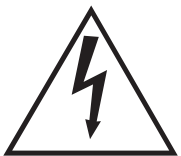

The lightning flash with arrowhead symbol, within the equilateral triangle, is intended to alert the user to the presence of uninsulated “dangerous voltage” within the product’s enclosure that may be of sufficient magnitude to constitute a risk of electrical shock.

IMPORTANT NOTICE: All Yamaha electronic products are tested and approved by an independent safety testing laboratory in order that you may be sure that when it is properly installed and used in its normal and customary manner, all foreseeable risks have been eliminated. **DO NOT** modify this unit or commission others to do so unless specifically authorized by Yamaha. Product performance and/or safety standards may be diminished. Claims filed under the expressed warranty may be denied if the unit is/has been modified. Implied warranties may also be affected.

SPECIFICATIONS SUBJECT TO CHANGE: The information contained in this manual is believed to be correct at the time of printing. However, Yamaha reserves the right to change or modify any of the specifications without notice or obligation to update existing units.

ENVIRONMENTAL ISSUES: Yamaha strives to produce products that are both user safe and environmentally friendly. We sincerely believe that our products and the production methods used to produce them, meet these goals. In keeping with both the letter and the spirit of the law, we want you to be aware of the following:

Battery Notice: This product MAY contain a small non-rechargeable battery which (if applicable) is soldered in place. The average life span of this type of battery is approximately five years. When replacement becomes necessary, contact a qualified service representative to perform the replacement.

Warning: Do not attempt to recharge, disassemble, or incinerate this type of battery. Keep all batteries away from children. Dispose of used batteries promptly and as regulated by applicable laws. Note: In some areas, the servicer is required by law to return the defective parts. However, you do have the option of having the servicer dispose of these parts for you.

Disposal Notice: Should this product become damaged beyond repair, or for some reason its useful life is considered to be at an end, please observe all local, state, and federal regulations that relate to the disposal of products that contain lead, batteries, plastics, etc.

NOTICE: Service charges incurred due to lack of knowledge relating to how a function or effect works (when the unit is operating as designed) are not covered by the manufacturer’s warranty, and are therefore the owners responsibility. Please study this manual carefully and consult your dealer before requesting service.

NAME PLATE LOCATION: The graphic below indicates the location of the name plate. The model number, serial number, power requirements, etc., are located on this plate. You should record the model number, serial number, and the date of purchase in the spaces provided below and retain this manual as a permanent record of your purchase.

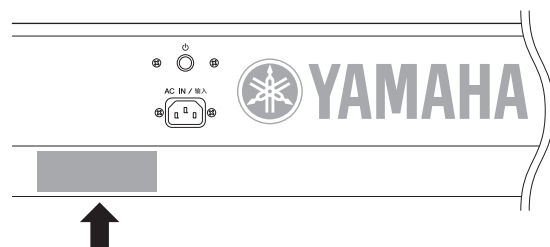

Model _____

Serial No. _____

Purchase Date _____

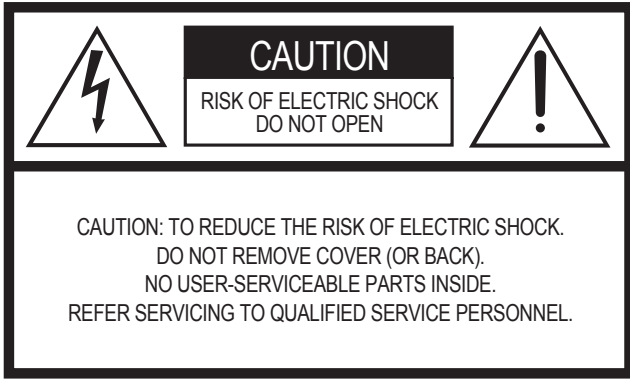

The above warning is located on the rear of the unit.

Explanation of Graphical Symbols

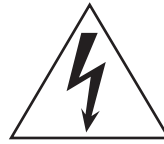

The lightning flash with arrowhead symbol within an equilateral triangle is intended to alert the user to the presence of uninsulated “dangerous voltage” within the product’s enclosure that may be of sufficient magnitude to constitute a risk of electric shock to persons.



The exclamation point within an equilateral triangle is intended to alert the user to the presence of important operating and maintenance (servicing) instructions in the literature accompanying the product.

IMPORTANT SAFETY INSTRUCTIONS

- 1 Read these instructions.
- 2 Keep these instructions.
- 3 Heed all warnings.
- 4 Follow all instructions.
- 5 Do not use this apparatus near water.
- 6 Clean only with dry cloth.
- 7 Do not block any ventilation openings. Install in accordance with the manufacturer’s instructions.
- 8 Do not install near any heat sources such as radiators, heat registers, stoves, or other apparatus (including amplifiers) that produce heat.
- 9 Do not defeat the safety purpose of the polarized or grounding-type plug. A polarized plug has two blades with one wider than the other. A grounding type plug has two blades and a third grounding prong. The wide blade or the third prong are provided for your safety. If the provided plug does not fit into your outlet, consult an electrician for replacement of the obsolete outlet.
- 10 Protect the power cord from being walked on or pinched particularly at plugs, convenience receptacles, and the point where they exit from the apparatus.

- 11 Only use attachments/accessories specified by the manufacturer.
- 12 Use only with the cart, stand, tripod, bracket, or table specified by the manufacturer, or sold with the apparatus. When a cart is used, use caution when moving the cart/apparatus combination to avoid injury from tip-over.
- 13 Unplug this apparatus during lightning storms or when unused for long periods of time.
- 14 Refer all servicing to qualified service personnel. Servicing is required when the apparatus has been damaged in any way, such as power-supply cord or plug is damaged, liquid has been spilled or objects have fallen into the apparatus, the apparatus has been exposed to rain or moisture, does not operate normally, or has been dropped.



WARNING

TO REDUCE THE RISK OF FIRE OR ELECTRIC SHOCK, DO NOT EXPOSE THIS APPARATUS TO RAIN OR MOISTURE.

(UL60065_03)

Information for Users on Collection and Disposal of Old Equipment



This symbol on the products, packaging, and/or accompanying documents means that used electrical and electronic products should not be mixed with general household waste.

For proper treatment, recovery and recycling of old products, please take them to applicable collection points, in accordance with your national legislation and the Directives 2002/96/EC.

By disposing of these products correctly, you will help to save valuable resources and prevent any potential negative effects on human health and the environment which could otherwise arise from inappropriate waste handling.

For more information about collection and recycling of old products, please contact your local municipality, your waste disposal service or the point of sale where you purchased the items.

[For business users in the European Union]

If you wish to discard electrical and electronic equipment, please contact your dealer or supplier for further information.

[Information on Disposal in other Countries outside the European Union]

This symbol is only valid in the European Union. If you wish to discard these items, please contact your local authorities or dealer and ask for the correct method of disposal.

PRECAUTIONS

PLEASE READ CAREFULLY BEFORE PROCEEDING

* Please keep this manual in a safe place for future reference.



WARNING

Always follow the basic precautions listed below to avoid the possibility of serious injury or even death from electrical shock, short-circuiting, damages, fire or other hazards. These precautions include, but are not limited to, the following:

Power supply/Power cord

- Only use the voltage specified as correct for the instrument. The required voltage is printed on the name plate of the instrument.
- Check the electric plug periodically and remove any dirt or dust which may have accumulated on it.
- Use only the supplied power cord/plug.
- Do not place the power cord near heat sources such as heaters or radiators, and do not excessively bend or otherwise damage the cord, place heavy objects on it, or place it in a position where anyone could walk on, trip over, or roll anything over it.
- Be sure to connect to an appropriate outlet with a protective grounding connection. Improper grounding can result in electrical shock.

Do not open

- Do not open the instrument or attempt to disassemble the internal parts or modify them in any way. The instrument contains no user-serviceable parts. If it should appear to be malfunctioning, discontinue use immediately and have it inspected by qualified Yamaha service personnel.

Water warning

- Do not expose the instrument to rain, use it near water or in damp or wet conditions, or place containers on it containing liquids which might spill into any openings. If any liquid such as water seeps into the instrument, turn off the power immediately and unplug the power cord from the AC outlet. Then have the instrument inspected by qualified Yamaha service personnel.
- Never insert or remove an electric plug with wet hands.

Fire warning

- Do not put burning items, such as candles, on the unit.
A burning item may fall over and cause a fire.

If you notice any abnormality

- If the power cord or plug becomes frayed or damaged, or if there is a sudden loss of sound during use of the instrument, or if any unusual smells or smoke should appear to be caused by it, immediately turn off the power switch, disconnect the electric plug from the outlet, and have the instrument inspected by qualified Yamaha service personnel.



CAUTION

Always follow the basic precautions listed below to avoid the possibility of physical injury to you or others, or damage to the instrument or other property. These precautions include, but are not limited to, the following:

Power supply/Power cord

- Always connect the three-pin attachment plug to a properly grounded power source. (For more information about the main power supply, see page 16.)
- When removing the electric plug from the instrument or an outlet, always hold the plug itself and not the cord. Pulling by the cord can damage it.
- Remove the electric plug from the outlet when the instrument is not to be used for extended periods of time, or during electrical storms.
- Do not connect the instrument to an electrical outlet using a multiple-connector. Doing so can result in lower sound quality, or possibly cause overheating in the outlet.

Location

- Do not expose the instrument to excessive dust or vibrations, or extreme cold or heat (such as in direct sunlight, near a heater, or in a car during the day) to prevent the possibility of panel disfiguration or damage to the internal components.
- Do not use the instrument in the vicinity of a TV, radio, stereo equipment, mobile phone, or other electric devices. Otherwise, the instrument, TV, or radio may generate noise.
- Do not place the instrument in an unstable position where it might accidentally fall over.
- Before moving the instrument, remove all connected cables.
- When setting up the product, make sure that the AC outlet you are using is easily accessible. If some trouble or malfunction occurs, immediately turn off the power switch and disconnect the plug from the outlet. Even when the power switch is turned off, electricity is still flowing to the product at the minimum level. When you are not using the product for a long time, make sure to unplug the power cord from the wall AC outlet.

Connections

- Before connecting the instrument to other electronic components, turn off the power for all components. Before turning the power on or off for all components, set all volume levels to minimum. Also, be sure to set the volumes of all components at their minimum levels and gradually raise the volume controls while playing the instrument to set the desired listening level.

Maintenance

- When cleaning the instrument, use a soft, dry cloth. Do not use paint thinners, solvents, cleaning fluids, or chemical-impregnated wiping cloths.

Handling caution

- Never insert or drop paper, metallic, or other objects into the gaps on the panel or keyboard. If this happens, turn off the power immediately and unplug the power cord from the AC outlet. Then have the instrument inspected by qualified Yamaha service personnel.
- Do not place vinyl, plastic or rubber objects on the instrument, since this might discolor the panel or keyboard.
- Do not rest your weight on, or place heavy objects on the instrument, and do not use excessive force on the buttons, switches or connectors.
- Do not use the instrument/device or headphones for a long period of time at a high or uncomfortable volume level, since this can cause permanent hearing loss. If you experience any hearing loss or ringing in the ears, consult a physician.

Saving data

Saving and backing up your data

- DRAM data (refer to the Reference Manual <separate PDF documentation>) is lost when you turn off the power to the instrument. Save the data to the flash ROM/the internal flash memory (see page 47)/a USB storage device/external device such as a computer.

Data stored to the flash ROM may be lost due to malfunction or incorrect operation. Save important data to a USB storage device/external device such as a computer.

- Never attempt to turn off the power while data is being written to Flash ROM (while an "Executing..." or "Please keep power on" message is shown). Turning the power off in this state results in loss of all user data and may cause the system to freeze (due to corruption of data in the Flash ROM). This means that this synthesizer may not be able to start up properly, even when turning the power on next time.

Backing up the USB storage device/external media

- To protect against data loss through media damage, we recommend that you save your important data onto two USB storage devices/external media.

Yamaha cannot be held responsible for damage caused by improper use or modifications to the instrument, or data that is lost or destroyed.

Always turn the power off when the instrument is not in use.

Welcome

A message from the S90 XS/S70 XS Development Team

Thank you for purchasing the Yamaha S90 XS/S70 XS Music Synthesizer.

We're extremely proud to introduce the new S90 XS/S70 XS as the successor to the original S90 ES. Equipped with exceptionally high-quality musical instrument sounds and a real piano-feel response, this is truly the instrument of choice for musicians and players worldwide, whatever the genre. Drawing on our long experience cultivated through years of synthesizer development, we designed this model not only for top professional musicians, but also for casual players and hobby musicians who want to have a greater level of high-quality sound, playability and advanced features—especially in live performance applications. To complete this lineup, we've added the S70 XS, a 76-key model which maintains the same keyboard touch as the 88-key model, yet provides the added value of portability.

The advanced and convenient features of the S90 XS/S70 XS do not stop there. The Remote Control functions and the Master Keyboard features have been enhanced and made more powerful to meet the demands of professional music production. We are proud and confident that the S90 XS/S70 XS can aid in your music making, and we're sure that it will be your first 'go-to' instrument in music situation, live performance, recording and so on.

In order to take full advantage of the S90 XS/S70 XS's functionality, please read this manual carefully. We also recommend that you keep this manual in a safe and handy place for future reference.

We really hope that the S90 XS/S70 XS will help your creativity and musical work grow by leaps and bounds. Enjoy!

Sincerely,

The Yamaha S90 XS/S70 XS Development Team

Accessories

- AC Power cord
- Owner's Manual (this book)
- Owner's Manuals CD-ROM x 1 (Reference Manual, Data List)
- Disk x 1 (containing DAW software)

About the accessory disk

Special Notice

- The software included in the accessory disk and the copyrights thereof are under exclusive ownership by Steinberg Media Technologies GmbH.
- Use of the software and this manual is governed by the license agreement which the purchaser fully agrees to upon breaking the seal of the software packaging. (Please read carefully the Software Licensing Agreement before installing the application.)
- Copying of the software or reproduction of this manual in whole or in part by any means is expressly forbidden without the written consent of the manufacturer.
- Yamaha makes no representations or warranties with regard to the use of the software and documentation and cannot be held responsible for the results of the use of this manual and the software.
- This disk is NOT for audio/visual purposes. Do not attempt to play the disk on an audio/visual CD/DVD player. Doing so may result in irreparable damage to your player.
- Note that Yamaha does not offer technical support for the DAW software in the accessory disk.

About the DAW software in the accessory disk

The accessory disk contains DAW software both for Windows and Macintosh.

NOTE

- Make sure to install DAW software under the "Administrator" account.
- In order to have continuous use of Cubase AI 4, including support and other benefits, you will need to register the software and activate your software license by starting it while the computer is connected to the Internet. Click the "Register Now" button shown when the software is started, then fill in all required fields for registration. If you do not register the product, you will be unable to use the application after a limited period of time expires.
- If you are using a Macintosh computer, double-click the "****.pkg" file to start installation.

For information about the minimum system requirements and latest information on the software in the disk, check the web site below.

<http://www.yamahasynth.com/download/>

About software support

Support for the DAW software in the accessory disk is provided by Steinberg on its website at the following address.
<http://www.steinberg.net>

You can visit the Steinberg site also via the Help menu of the included DAW software. (The Help menu also includes the PDF manual and other information on the software.)

S90 XS/S70 XS Main Features

■ Huge amount of waveforms and vast sound selection, including top-quality piano sounds

The S90 XS/S70 XS features a whopping 142 MB of exceptionally high-quality piano waveforms, including many newly sampled sounds, and a vast variety of Voices directly derived from the flagship MOTIF XS Music Production Synthesizer-giving you a total of 456 MB of available waveforms.

■ Balanced Hammer Keyboard—with both 88 and 76 keys—provides natural touch and response

The S90 XS/S70 XS features a sophisticated Balanced Hammer Keyboard (with Initial Touch/Aftertouch) which utilizes Yamaha's long-standing know-how cultivated in its acoustic piano and synthesizer development. The 88-key model gives you full-scale piano performance, while the smaller 76-key model offers greater portability and ease in transporting.

■ Performance Creator

The S90 XS/S70 XS features a Performance Creator function which provides quick and easy Layer/Split /Drum Assign assignments of your original Performances based on your favorite Voices. You can utilize the current effects and settings of the Voices, allowing you to come up with your own original Voices very quickly.

■ Intuitive Panel Composition

The buttons, Knobs and Sliders are well designed and logically placed for optimum, intuitive operation, especially in live performance. For example, you can quickly select a Part, use the Part switch to turn it on/off, set the Arpeggio switch on/off, switch Arpeggio Hold on/off—all with the top panel controls—and edit important parameters via the Knobs and Sliders. A convenient Panel Lock function, which prevents unintended changes during performance, and a Tap Tempo function for the Arpeggio are also available on the top panel.

■ Audio Rec/Play Function

You can record your performance to a USB storage device or internal flash memory as a wave file, or you can play back audio files which have been created on DAW software. You can also play the keyboard along with audio file playback via the Audio Rec/Play function.

■ DAW Remote Function

The S90 XS/S70 XS features a DAW Remote function for music production convenience. This allows you to store 50 different control templates and have easy, intuitive control over your main DAW software and VST instruments directly from the panel controls of the S90 XS/S70 XS.

■ Voice Editor and Remote Editor for Detailed Editing

When using Cubase series software compatible with VST3 technology, the S90 XS/S70 XS Editor VST can be conveniently used in the same manner as software VST instruments for editing the detailed parameters. When using in stand-alone mode, the S90 XS/S70 XS Editor for Studio Manager V2 is also available to edit the detailed parameters. For setting of the Remote Control function and the Remote Template, the S90 XS/S70 XS Remote Editor allows you to manage them. You can download them on our web site.

<http://www.yamahasynth.com/download/>

About this Manual

Owner's Manual (this book)

Explains operations of the top panel controls.

PDF documentation (includes the Owner's Manual CD-ROM)

■ Reference Manual

Explains in detail about the sound-related parameters and effect parameters.

■ Data List

This contains various important lists such as the Voice List, Wave List, Multi List, MIDI Implementation Chart, Performance List, Master Program List, Mixing Template List, Arpeggio Type List and Remote Control Function List.

How to use the PDF manuals

The Reference Manual and the Data List are provided as data documents in PDF format. These PDF files can be viewed and read on a computer. When using Adobe® Reader® to view a PDF file, you can search for specific words, print a specific page or link to open a desired section in the manual. The term search and link functions are especially convenient methods of navigating through a PDF file, and we recommend that you use them.

The latest version of Adobe Reader can be downloaded from the following URL.

<http://www.adobe.com/products/reader/>

Special Notice

- The contents of this Owner's Manual and the copyrights thereof are under exclusive ownership by Yamaha Corporation.
- The illustrations and LCD screens as shown in this Owner's Manual are for instructional purposes only, and may appear somewhat different from those on your instrument.
- This product incorporates and bundles computer programs and contents in which Yamaha owns copyrights or with respect to which it has license to use others' copyrights.
Such copyrighted materials include, without limitation, all computer software, style files, MIDI files, WAVE data, musical scores and sound recordings. Any unauthorized use of such programs and contents outside of personal use is not permitted under relevant laws. Any violation of copyright has legal consequences. DON'T MAKE, DISTRIBUTE OR USE ILLEGAL COPIES.
- This device is capable of using various types/formats of music data by optimizing them beforehand to the proper format music data for use with the device. As a result, this device may not play them back precisely as their producers or composers originally intended. Copying of the commercially available musical data including but not limited to MIDI data and/or audio data is strictly prohibited except for your personal use.
- Such copyrighted materials include, without limitation, all computer software, style files, MIDI files, WAVE data, musical scores and sound recordings. Any unauthorized use of such programs and contents outside of personal use is not permitted under relevant laws. Consult a legal advisor before using such data.
- Windows is the registered trademark of Microsoft® Corporation.
- Apple and Macintosh are trademarks of Apple Inc., registered in the U.S. and other countries.
- Steinberg and Cubase are the registered trademarks of Steinberg Media Technologies GmbH.
- The company names and product names in this Owner's Manual are the trademarks or registered trademarks of their respective companies.
- All other trademarks are the property of their respective holders.

Contents

Welcome.....	6	Using a Connected Computer	36
Accessories.....	6	Connecting to a computer	36
About the accessory disk.....	6	Using as a multi-timbral tone generator (Multi mode)	38
S90 XS/S70 XS Main Features.....	7	Remote-controlling the software (Remote mode)	38
About this Manual.....	8	Editing more detailed parameters of the Voice	40
Controls and Functions	10	Playing the Keyboard Along with Playback of the MIDI File.....	41
Top panel	10	Using as a Master Keyboard (Master Mode)	43
Rear Panel.....	15	Storing the Edited Voice/Performance/Multi	43
Setting Up	16	Making settings for use as a master keyboard.....	43
Power Supply	16	Making Global System Settings (Utility Mode)	45
Connecting speakers or headphones.....	16	Saving/Loading Data (File Mode)	47
Powering Up the System.....	16	Saving the settings to a USB storage device	47
Adjusting the volume and the brightness of the display	17	Loading the settings from a USB storage device	48
Starting Up	17	USB storage devices	49
Selecting Voices.....	17	Appendix	50
Playing demo songs.....	17	Display Messages.....	50
Resetting the User Memory to the Initial Factory Settings .	18	Troubleshooting	52
Start Guide	19	Specifications	58
Modes	19	Index	59
Basic Instructions.....	20		
Playing the Keyboard in the Voice mode	21		
Selecting a preset Voice	21		
Using the Category Search function	22		
Grouping your most-used Voices together—Favorite Category.....	22		
Changing the tonal qualities of the Voice.....	23		
Voice Editing	24		
Enhancing the sound with Effects.....	24		
Using the Arpeggio function	26		
Creating a New Performance by Using Your Favorite Voice (Performance Creator)	28		
Layer—Playing different Voices together.....	28		
Split—Playing two different Voices with your left and right hands.....	29		
Drum Assign—Layering a drum Part with the current Voice	30		
Changing the drum pattern (Arpeggio Type).....	30		
Assigning a name to the Performance.....	31		
Playing the Keyboard in the Performance Mode	32		
Selecting a Performance	32		
Changing the timbre of the Voice.....	32		
Singing with a Connected Microphone	33		
Recording/Playing Back with a USB Storage Device (Audio Record/Play Mode)	34		
Recording.....	34		
Playing back the recording	35		

Controls and Functions

Top panel

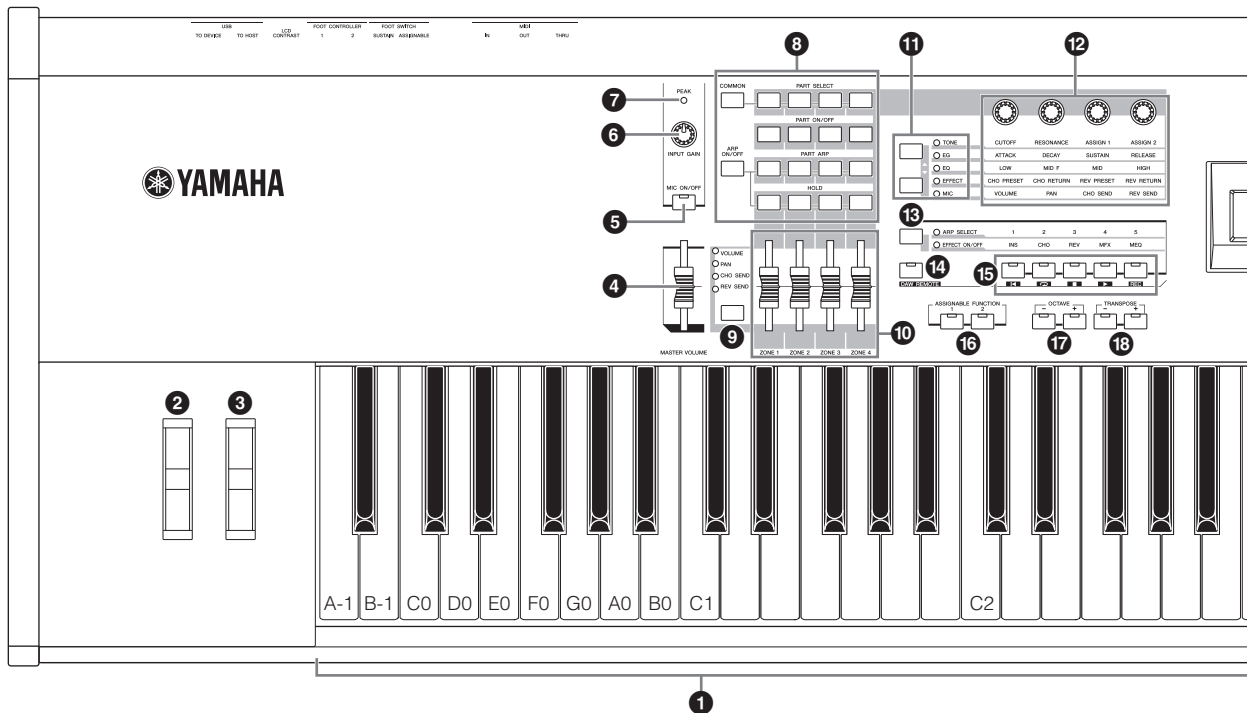

1 Keyboard

The S90 XS features a 88-key keyboard, while the S70 XS has 76 keys. All are equipped with a touch response feature (both initial touch and after touch). With initial touch, the instrument senses how strongly or softly you play the keys, and uses that playing strength to affect the sound in various ways, depending on the selected Voice. With after touch, the instrument senses how much pressure you apply to the keys while playing, and uses that pressure to affect the sound in various ways, depending on the selected Voice.

NOTE The keyboard range of the S90 XS is A -1 to C7; the range of the S70 XS is E0 to G6.

2 Pitch Bend wheel

Controls the pitch bend effect. You can also assign other functions to this controller.

3 Modulation wheel

Controls the modulation effect. You can also assign other functions to this controller.

4 MASTER VOLUME slider

Adjusts the volume of the overall sound. Move the slider upwards to raise the output level from the OUTPUT L/R jacks and the PHONES jack.

5 [MIC ON/OFF] button

Press the [MIC ON/OFF] button to switch the on/off status of the MIC INPUT jack.

6 INPUT GAIN knob

Use this to adjust the input gain of the audio signals at the MIC INPUT jack. Depending on the connected microphone, you may need to adjust this for optimum level. The volume level is increased as the knob is rotated to the right and decreased as it is rotated to the left.

7 PEAK indicator

This indicator lights up when the input signal level is 3dB below clipping. Adjust the INPUT GAIN so that the indicator rarely lights up at signal peak.

8 Performance Control buttons

These buttons let you control the functions that affect Performances and Multis. You can select the part to be controlled by the knobs and set the Arpeggio-related parameters for each Part. In the Multi mode, the four parts to be edited will correspond to 1 - 4, 5 - 8, 9 - 12 or 13 - 16 (depending on the currently selected Part).

[COMMON] button

In the Performance mode, pressing this button lets you use the knobs to control the Common parameters.

In the Performance Edit mode, pressing this button will call up the Common Edit Select display.

[PART SELECT] 1 - 4 buttons

In the Performance mode and Multi mode, pressing one of these buttons will select the Part to be controlled by the knob.

In the Voice Edit mode, pressing one of these buttons will select the Element to be edited via the Quick Edit function.

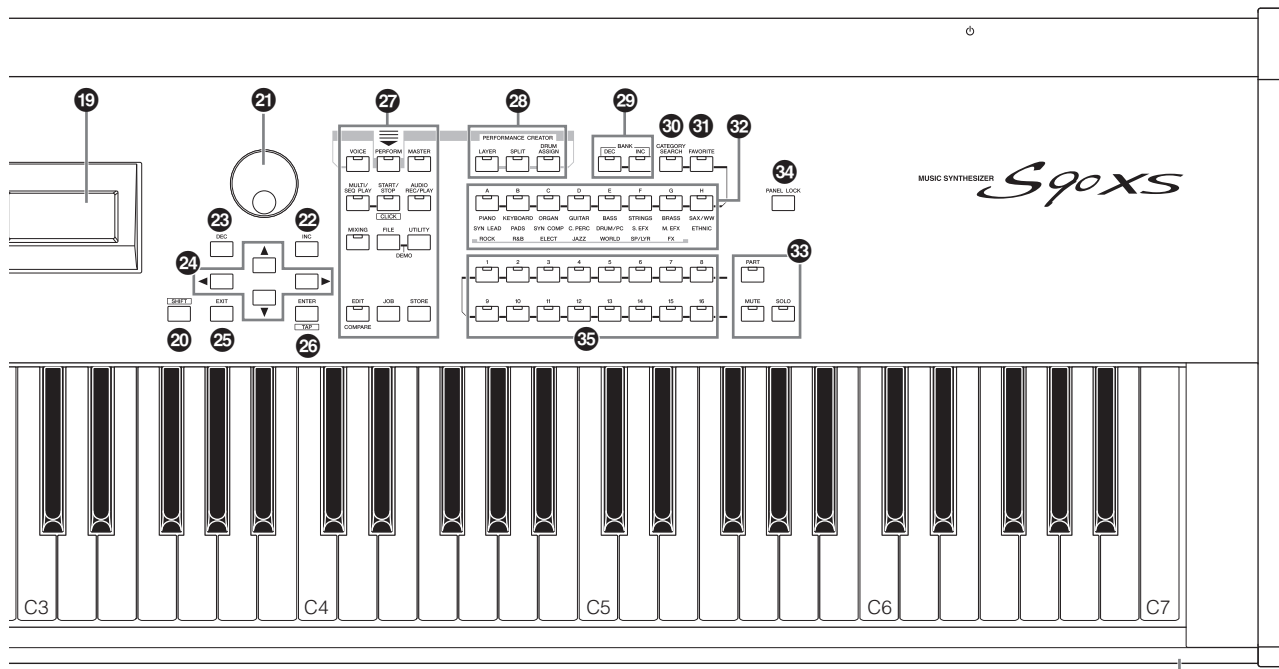

[PART ON/OFF] 1 – 4 buttons

These buttons turn each Part on and off. In the Voice mode, only Part 1 is available and is always turned on.

[ARP ON/OFF] button

Turns the “Arp Switch” (a common parameter) on/off. When this button is turned on, the Arpeggio function is available.

[PART ARP] 1 – 4 buttons

Turn Arpeggio playback on or off for each Part in the Performance/Multi Mode.

In the Voice mode, pressing either of the [ARP ON/OFF] and [PART ARP] 1 buttons will turn the Arpeggio playback on or off for Part 1, since only Part 1 is available.

[HOLD] 1 – 4 buttons

When some of these buttons are turned on, the Arpeggio playback of the corresponding Parts cycles automatically even if you release your fingers from the keys, and continues to cycle until the next key is pressed. In other words, these buttons turn the “Arp Hold” (a part parameter) on or off. In the Voice mode, only Part 1 is available.

9 Slider Function button

Pressing this button changes the functions assigned to the four Sliders. The lamp next to the currently active parameters will light.

In the Voice Edit mode, pressing this button a few times will turn all the lamps off, indicating that the Sliders can be used to control the Element levels of the currently edited Voice.

10 Sliders

These control the parameter selected via the Slider Function button.

In the Voice mode, only the leftmost Slider is available.

In the Performance mode and Multi mode, these Sliders control the parameter of the corresponding Parts.

In the Master mode, when “Zone Switch” and “Knob Slider Zone Switch” are on, the Sliders will control the MIDI Control Change message that is specified for each zone. Otherwise, the function is the same as that in the Voice/Performance/Multi mode.

NOTE If all of the Sliders are set to the minimum, you may not hear any sound from the instrument, even when playing the keyboard. If this is the case, raise all the Sliders to a suitable level.

NOTE The MASTER VOLUME slider adjusts the audio output level from this instrument. On the other hand, these Sliders adjust the volume for the Part of the Performance/Multi as a parameter. Accordingly, the values set via the Sliders can be stored as the Voice, Performance, Song, or Pattern data.

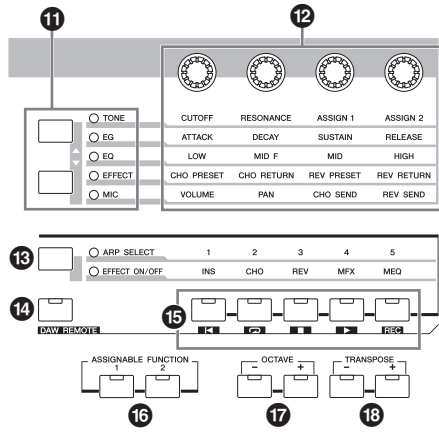

11 Knob Function buttons

Pressing these buttons change the functions assigned to the four Knobs. The lamp next to the currently active parameters will light. In the Voice mode, the function of each Knob is applied to the current Voice; in the Performance/Multi mode, the function of each Knob is applied only to the currently selected Part (or to all Parts depending on the setting).

NOTE Controlling the Knobs of the “EFFECT” function will always affect the sound of all Parts. Controlling the Knobs of the “MIC” function will work independently.

12 Knobs

These four highly versatile Knobs let you adjust various aspects or parameters of the current Voice. Use the Knob Function buttons to change the parameter set for the Knobs.

13 Arpeggio/Effect Function button

Pressing this button changes the functions assigned to the five Function buttons. You can select one of two different functions: selecting the Arpeggio from 1 – 5 and turning each effect on/off.

14 [DAW REMOTE] button

The Remote mode lets you control sequencer software on your computer from the panel controls of the instrument. Turn the [DAW REMOTE] button on to enter the Remote mode.

15 Function buttons

In the Remote mode, “Top,” “Repeat On/Off,” “Stop,” “Play” and “Record” are assigned to each of these buttons. In other modes, the functions specified via the Arpeggio/Effect Function button are assigned to these buttons.

16 ASSIGNABLE FUNCTION [1]/[2] buttons

You can call up a specific Element of the selected Voice by pressing each of these buttons during your keyboard performance. In addition, you can assign other functions to these buttons.

17 OCTAVE [-]/[+] buttons

Use these buttons to change the note range of the keyboard. To restore the normal octave setting, press both buttons simultaneously.

18 TRANSPOSE [-]/[+] buttons

Use these buttons to raise or lower the pitch of the note by one semitone. To restore the normal octave setting, press both buttons simultaneously.

19 LCD (Liquid Crystal Display)

The backlit LCD displays the parameters and values related to the currently selected operation or mode.

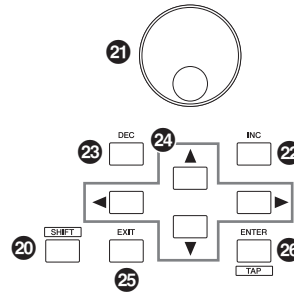

20 [SHIFT] button

Pressing this button along with another button enables you to execute various commands. The main functions are as follows.

[SHIFT] +	Functions
START/STOP	CLICK ON/OFF
AUDIO REC/PLAY	Move to Rec Standby display in the Audio Rec/Play mode
VOICE	Bulk dump the edited Voice
PERFORM	Bulk dump the edited Performance
MULTI/SEQ PLAY	Bulk dump the edited Multi
ENTER	Tap tempo for the Arpeggio
INC/DEC, Data dial	Change the program number ±10. Change the selected parameter ±10 on Edit display
Cursor [◀]/[▶]	Select the display mode in the LCD
Knobs 1 – 4	Change the parameter value continuously
FAVORITE	Add/remove the current Voice/Performance/Multi to/from the favorite category
PANEL LOCK	Move to Utility Panel Lock display

NOTE All the functions are listed in the Data List (PDF file).

21 Data dial

For editing the currently selected parameter. To increase the value, turn the dial right (clockwise); to decrease the value, turn the dial left (counter-clockwise). If a parameter with a wide value range is selected, you can change the value in broader strokes by quickly turning the dial.

22 [INC] button

For increasing the value of the currently selected parameter.

23 [DEC] button

For decreasing the value of the currently selected parameter.

24 Cursor buttons

The cursor buttons move the “cursor” around the LCD display screen, highlighting and selecting the various parameters.

25 [EXIT] button

The menus and displays of the S90 XS/S70 XS are organized according to a hierarchical structure. Press this button to exit from the current display and return to the previous level in the hierarchy. Also use it to cancel a Job or a Store operation.

26 [ENTER] button

Use this button to call up the display of the selected menu. Also use this button to execute a Job or a Store operation.

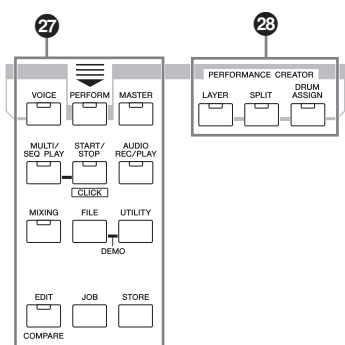

27 Mode buttons

These buttons select the S90 XS/S70 XS operating modes (e.g., Voice mode).

28 PERFORMANCE CREATOR

This function is for quickly editing/creating a new Performance based on the current Voice. This would come in handy when a certain Voice has effect settings that you want to use in your Performance program.

[LAYER] button

This function is for editing a layer Performance based on the current Voice. When pressing this button, the Category Search display appears on the display and you can select the Voices for use in a layer.

[SPLIT] button

This function is for editing a split Performance based on the current Voice. When pressing this button, the Category Search display appears on the display and you can select the Voices for use in a split.

[DRUM ASSIGN] button

This function is for editing a Performance with a Drum Voice based on the current Voice. When pressing this button, the Category Search display appears on the display and you can select the desired Drum Voice. Also, Arpeggio will be set to on automatically.

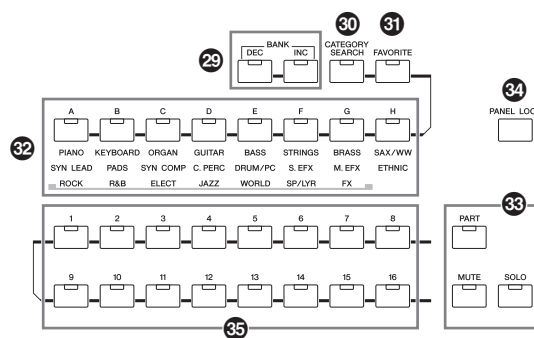

29 BANK [DEC]/[INC] buttons

Each button selects a Voice or Performance Bank.

30 [CATEGORY SEARCH] button

When this button is turned on in the Voice/Multi/Performance Part Edit mode, the [A] – [H] buttons can be used to select the main category of the Voice. When this button is turned on in the Performance mode, the [A] – [H] buttons can be used to select the main category of the Performance.

31 [FAVORITE] button

Use this convenient function to store all your favorite, often-used Voices in a single, easy-to-access location and call them up by pressing the [FAVORITE] button. You can add the current program to a favorite category by simultaneously holding down the [SHIFT] button and pressing this button. This is one more useful way you can quickly select the Voices you need from the huge number available on the instrument.

32 [A] – [H] buttons

Each button selects a Program.

When the [CATEGORY SEARCH] button is turned on, these buttons can be used to select the Main category (printed below each button).

33 [PART] button

[MUTE] button

[SOLO] button

Changes the function of the Number [1] – [16] button. (Refer to “Number [1] – [16] buttons” section.)

34 [PANEL LOCK] button

Turning on this button disables the panel operations. The Panel Lock function can temporarily disable panel operations and prevent unintended operation during live performance. The Panel Lock function affects all controls, with the exception of the Modulation wheel, the Pitch Bend wheel, Footswitch, INPUT GAIN and the MASTER VOLUME. The target buttons for the Panel Lock function can be set up in the Utility Panel Lock display.

35 Number [1] – [16] buttons

Use of these buttons differs depending on the on/off status of the [PART], [MUTE] and [SOLO] buttons. The indicator lights if each button is turned on

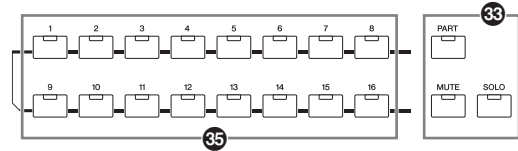

Mode	[PART]	[MUTE]	[SOLO]
Voice Play	Keyboard transmit channel setting	—	—
Normal Voice Edit	—	Element selection ([1] – [8]) Element Mute setting ([9] – [16])	Element selection ([1] – [8] or [9] – [16])
Performance Play	Keyboard transmit channel setting	Part Mute setting ([1] – [4])	Solo part selection ([1] – [4])
Performance Edit	Part selection ([1] – [4])	Part Mute setting ([1] – [4])	Solo Part selection ([1] – [4])
Multi Play	Part selection ([1] – [16])	Part Mute setting ([1] – [16])	Solo part selection ([1] – [16])
Multi Edit	Part selection ([1] – [16])	Part Mute setting ([1] – [16])	Solo part selection ([1] – [16])
Master Play	Keyboard transmit channel setting (when memorizing the Voice mode or Performance mode to the current Master) or Part selection (when memorizing the Multi mode to the current Master)	Part Mute setting ([1] – [4]) (Performance) Part Mute setting ([1] – [16]) (Multi)	Solo Part selection ([1] – [4]) (Performance) Solo Part selection ([1] – [16]) (Multi)
Master Edit	Changes the Edit mode from Common Edit to Zone Edit and Zone selection ([1] – [4])	—	—

Rear Panel

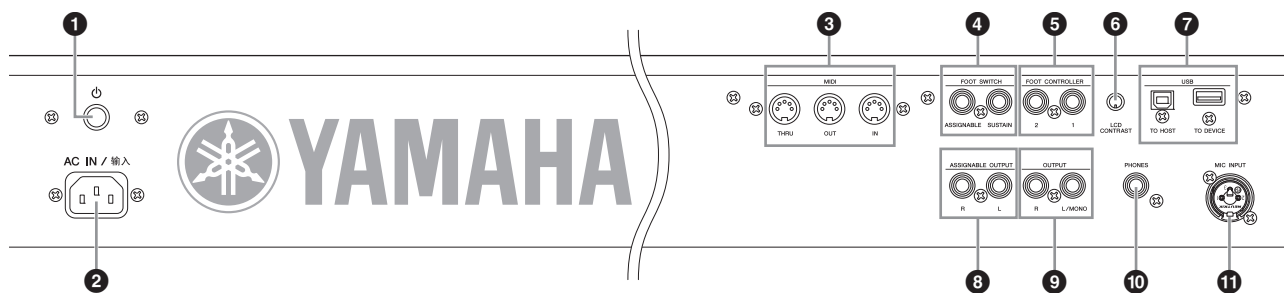

1 ⏻ (Power switch)

Press to turn power ON (⏻) or OFF (⏻).

2 AC IN socket

Connects to the included power cord.

Use only the AC power cord supplied with the S90 XS/S70 XS.

3 MIDI IN, OUT, and THRU terminals

MIDI IN is for receiving control or performance data from another MIDI device, such as an external sequencer. Use this connector to control the synthesizer from an external MIDI device. MIDI OUT is for transmitting all control, performance and playback data from the S90 XS/S70 XS to another MIDI device, such as an external sequencer.

Likewise, you can use the S90 XS/S70 XS to control external MIDI instruments. MIDI THRU is simply for redirecting any received MIDI data (via MIDI IN) to connected devices, allowing convenient chaining of additional MIDI instruments.

4 FOOT SWITCH jacks

For connection of an optional FC3/FC4/FC5 Footswitch to the SUSTAIN jack and a FC4/FC5 Footswitch to the ASSIGNABLE jack. When connected to the SUSTAIN jack, the Footswitch controls sustain. When connected to ASSIGNABLE, it can control one of various different assignable functions.

5 FOOT CONTROLLER 1 and 2 jacks

An optional foot controller (FC7, etc.) can be connected here. Each jack lets you continuously control one of various different assignable functions--such as volume, tone, pitch, or other aspects of the sound.

6 LCD Contrast control

Use this control to set the LCD display for optimum legibility.

7 USB connectors

There are two different types of USB connectors, and the rear panel of the instrument features both. The USB TO HOST connector is used to connect this instrument to the computer via the USB cable. The USB connection between the instrument and the computer can only be used for transfer of MIDI data. Unlike MIDI, USB can handle multiple ports via a single cable. The USB connection between the instrument and the computer can only be used for transfer of MIDI data. No audio data can be transferred via USB.

The USB TO DEVICE connector is used to connect this instrument to a USB storage device (hard disk drive, CD-ROM drive, flash disk, etc.) via USB. This lets you save the data created on this instrument to an external USB storage device as well as load data from the device to the instrument. Save/Load operations can be performed in the File mode.

8 ASSIGNABLE OUT L and R jacks

These outputs are independent of the main output (at the L/MONO and R jacks below), and can be freely assigned to any of the Drum Voice keys or the Parts. This lets you route specific Voices or sounds for processing with a favorite outboard effect unit.

The Parts which can be assigned to these jacks are as follows:

- Drum Voice key to which the drum/percussion instrument is assigned
- Each part of the Performance*
- Each part of the Multi*
- Click (metronome)

*Includes the Audio Input Part (A/D IN Part)

9 OUTPUT L/MONO and R jacks

Line level audio signals are output via these phone jacks. For monophonic output, use just the L/MONO jack.

10 PHONES jack

A pair of headphones can be plugged in here. (Standard stereo phone jack)

11 MIC INPUT jack

External audio signals can be input via this combo jack. A microphone can be connected to the MIC INPUT jacks. This audio can be used as input for the A/D Input Part in the Performance/Multi mode. Use an XLR plug or 1/4" mono phone plug.

Setting Up

Power Supply

Connect the supplied AC power cord in the following order. Make sure the Power switch on the S90 XS/S70 XS is set to OFF.

- 1 Connect the supplied power cord to the AC IN on the instrument's rear panel.**
- 2 Connect the other end of the power cord to an AC outlet.**

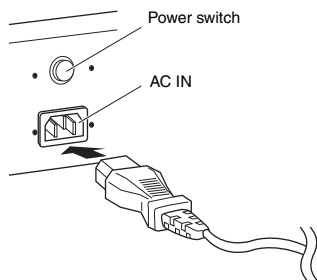

NOTE Follow this procedure in reverse order when disconnecting the power cord.



CAUTION

Make sure your S90 XS/S70 XS meets the voltage requirement for the country or region in which it is being used. The power cord includes a grounding pin to prevent electrical shock and damage to equipment. When connecting to an outlet, connect the adaptor's ground lead to the ground screw. If you're unsure how to connect, then contact your Yamaha dealer or service center (page 63).



WARNING

Use only the AC power cord supplied with the S90 XS/S70 XS. The use of an inappropriate replacement can pose a fire and shock hazard!



CAUTION

Even when the switch is in the OFF position, a small amount of electricity is still flowing to the unit. When you are not using the S90 XS/S70 XS for a long time, make sure to unplug the AC power adaptor from the wall AC outlet.

Connecting speakers or headphones

Since the S90 XS/S70 XS has no built-in speakers, you will need to monitor the sound of the instrument by using external equipment. Connect a set of headphones, powered speakers, or other playback equipment as illustrated below. When making connections, be sure that your cables have the appropriate ratings.

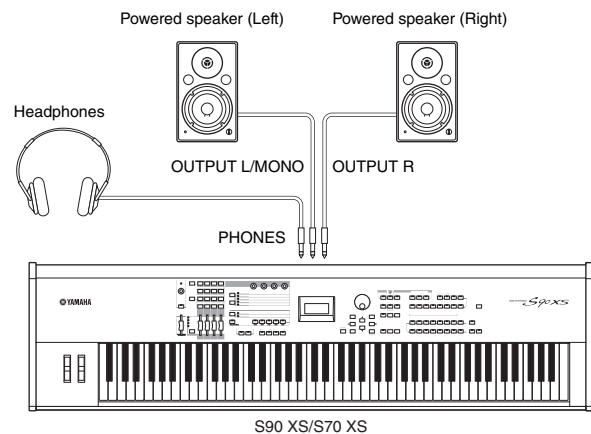

Powering Up the System

Make sure the volume settings of the S90 XS/S70 XS and external devices such as powered speakers are turned down to the minimum before turning the power on. When connecting the S90 XS/S70 XS to the powered speakers, turn on the power switch of each device in the following order.

When turning the power on:

First, the S90 XS/S70 XS, then the connected powered speakers.

When turning the power off:

First, the connected powered speakers, then the S90 XS/S70 XS.

Please keep in mind that the Power switch is located at the right side (from the view of the keyboard) of the AC IN socket on the rear panel of the S90 XS/S70 XS.

Adjusting the volume and the brightness of the display

Adjust the volume levels of the S90 XS/S70 XS and the connected amplifier/speaker system.

NOTE When connecting to a set of powered speakers or PA equipment, set the MASTER VOLUME to about 70%, then raise the volume of the powered speakers or PA equipment to the appropriate level.

If the display is not easily visible, use the LCD CONTRAST knob on the rear panel to adjust for optimum visibility.

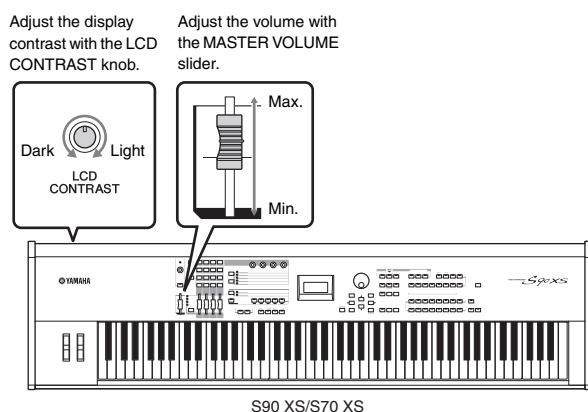

CAUTION

Do not listen with the headphones at high volume for long periods of time. Doing so may cause hearing loss.

Starting Up

Try playing some of the realistic and dynamic S90 XS/S70 XS sounds from the keyboard now. When you turn the power on, the display below appears.

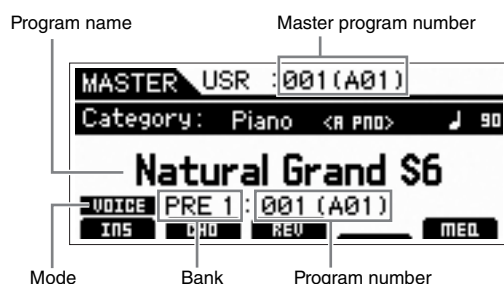

NOTE In the default settings, the Master mode is selected. See page 19 for details about the modes.

NOTE Keep in mind that the example displays shown in this manual are for instruction purposes only, and may appear somewhat different from those on your instrument.

In this condition you can play the keyboard and hear the sounds of the selected program.

In the default setting, the Master mode provides a total of 128 programs each of which includes the mode (Voice, Performance, Multi) and its program number.

The top of the Master Play display indicates the Master program number and the status (Mode, Bank, Program Number and its name) registered to the current Master program.

NOTE For details about Banks, see pages 21 and 32.

Selecting Voices

In the default setting, the Master mode provides a total of 128 programs each of which includes the mode (Voice, Performance, Song and Multi) and its program number. Try out the different Master programs to play various Voices and Performances. You can change the Master program number by using the [INC] button, [DEC] button, or the data dial.

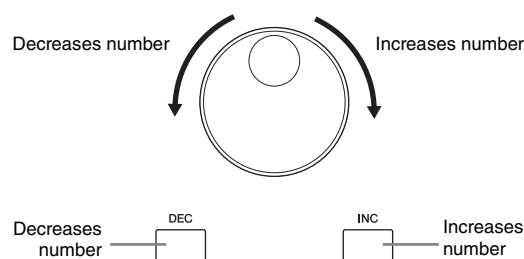

Playing demo songs

The S90 XS/S70 XS features a variety of demo songs, showcasing its dynamic sound and sophisticated functions. Here's how to play them back.

NOTE Make sure the S90 XS/S70 XS is ready for playback. Details are given in the section "Setting Up" on page 16.

- 1 Simultaneously hold the [FILE] button and press the [UTILITY] button.
- 2 The DEMO screen is shown in the display. Select the song with the data dial or cursor [▲]/[▼] buttons.
- 3 Press the [ENTER] button to start playback of the DEMO song.
Pressing the [ENTER] button during playback stops playback at the current point in the Song then pressing this again starts playback from that point.
- 4 To stop playback, press the [EXIT] button.
- 5 To close the Demo Song display, press any of the [EXIT], [VOICE], [PERFORM], [MASTER] and [MULTI/SEQ PLAY] buttons.

Resetting the User Memory to the Initial Factory Settings

The S90 XS/S70 XS has a Factory Set function for restoring your S90 XS/S70 XS's memory to the factory default settings.

This lets you restore the S90 XS/S70 XS's default program, as well as its System and other settings.

CAUTION

When the factory settings are restored, all the data that you created in each mode or saved to internal flash memory will be erased. Take care so as not to lose important data. Be sure to save all important data to a computer before executing this procedure (page 47).

1 Press the [UTILITY] button.

The Utility Select display appears.

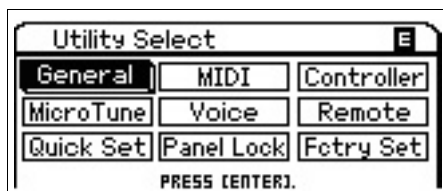

2 Select "Fctry Set" by using the Cursor [▲]/[▼]/[◀]/[▶] buttons, then press the [ENTER] button.

The Factory Set display appears.

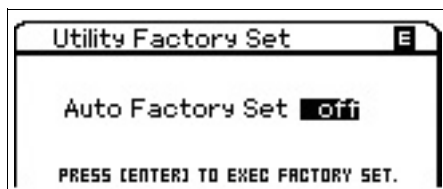

CAUTION

When setting the Auto Factory Set parameter to on and pressing the [ENTER] button, the Factory Set will automatically be executed each time the power is turned on.

Keep in mind that this also means that your original data in Flash ROM will be erased each time you turn on the power. Therefore, the Auto Factory Set parameter should normally be set to off. When setting the Auto Factory Set parameter to off and pressing the [ENTER] button, the Factory Set will not be executed when turning the power on next time.

Please note that the setting of the Power On Auto Factory Set on this display will be stored automatically by executing Factory Set.

3 Press the [ENTER] button to execute the Factory Set operation.

The display prompts you for confirmation. Press the [ENTER] button again to execute Factory Set.

After Factory Set has been completed, operation returns to the Master Play display.

Press the [EXIT] button to cancel the Factory Set operation.

CAUTION

For Factory Set operations that take longer to process, you will see the message "Now executing Factory Set..." during processing. While such a message is shown (while data is being written to Flash ROM), never attempt to turn off the power. This means that this tone generator may not be able to start up properly, even when turning the power on next time.

Modes

There are several operation modes in the S90 XS/S70 XS, and they can be selected by using the seven mode buttons. These modes include: Voice, Performance, Multi, Master and Sequence Play. Depending on the selected mode, you can play and perform on the keyboard and create your own original music.

If you want to play the keyboard conventionally, use the Voice or Performance mode. If you're creating music, particularly multi-part arrangements, use the Multi mode.

In addition, the following modes are available: the Audio Record/Play mode for recording your keyboard performance as audio data and playing back audio files, the File mode for managing files for saving the data you created on this synthesizer, and the Utility mode for making overall settings.

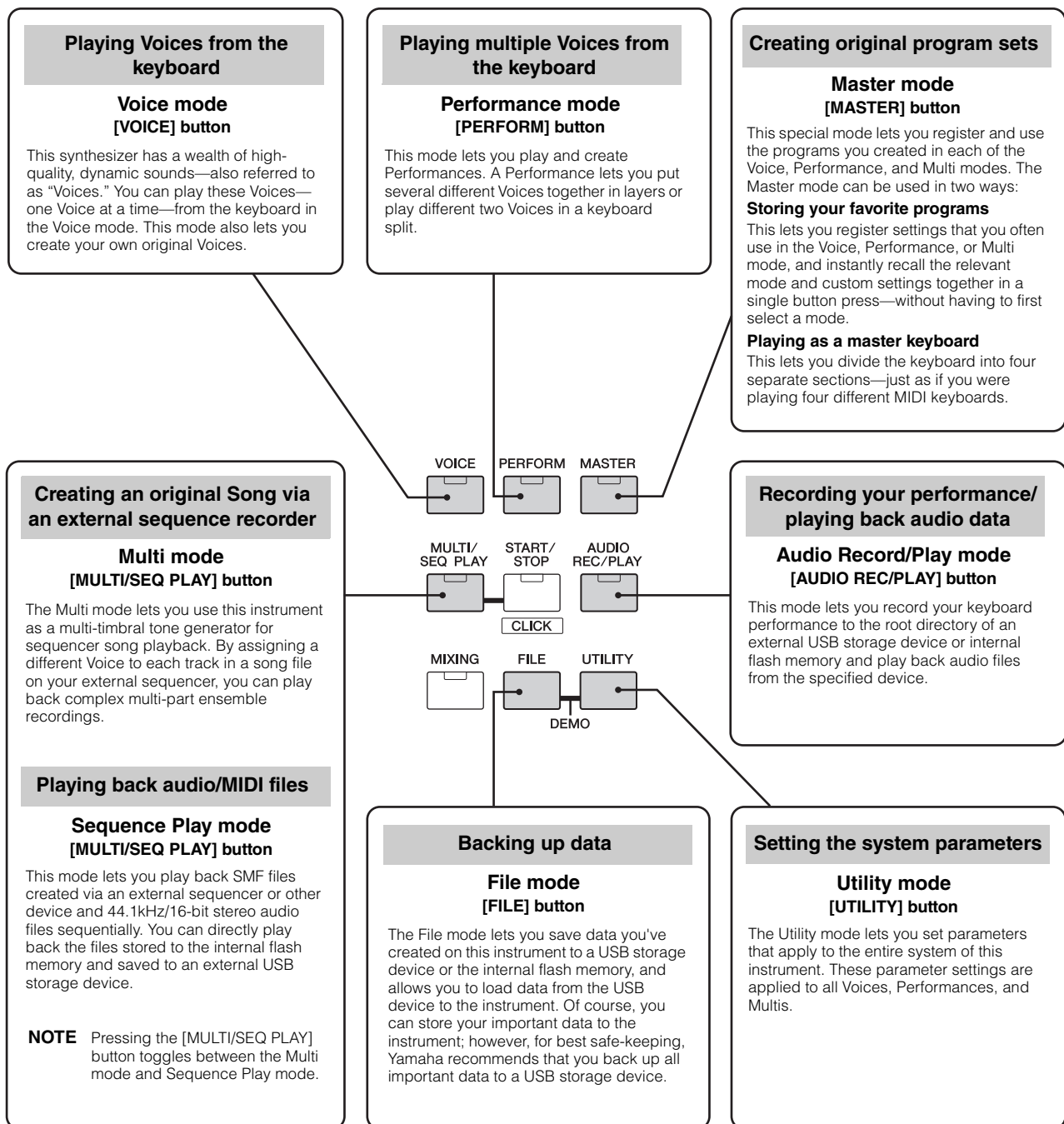

Basic Instructions

Voices—the basic building blocks of the S90 XS/S70 XS

Voices—created in the Voice mode—are the basic sonic building blocks for the other modes of this instrument. The Performance and Multi programs are made up of different Voices.

This instrument features an exceptionally wide variety of preset Voices for playing in virtually any musical style. Try searching through the Voices to find your favorites. Once you've explored them and feel comfortable with them, try branching out creatively and use the editing features to make your own original Voices.

Selecting a preset Voice

→ page 21

Changing the tonal qualities of the Voice

→ page 23

Combining several Voices to create a Performance or Multi

If you want to play several different Voices together simultaneously, select a Performance. The 384 Performances are preprogrammed and be used as such, but can also be changed and customized to suit your own needs. By using the Performance Creator feature, you can create your own original Performance based on the Voice currently selected in the Voice mode.

To use this instrument as a multi-timbral tone generator with computer DAW software, select a Multi. With the help of the Multis, this instrument can be used to play back MIDI song files from a connected USB or internal flash memory device.

Creating a new Performance in the Voice mode by using your favorite Voices (Performance Creator)

→ page 28

Selecting a Performance

→ page 32

Creating music using a Multi and your computer

→ page 38

Playing back a MIDI file

→ page 41

Master mode—create a master keyboard setup or instantly call up your desired programs

The Master mode lets you register your favorite Voices, Performances, and Multis together into easy-to-select Master programs. No matter what mode is used—Voice, Performance or Multi—you can have it instantly and automatically selected when you call up the appropriate Master. The Master mode can also be used to divide the keyboard into four sections—each with its own Voice—just as if you were playing four different MIDI keyboards.

Making Master mode settings

→ page 43

Convenient remote control of your computer DAW software

The panel of this instrument also serves as a convenient control surface for your computer music system. Use the buttons and controllers to control the audio mixer, pan adjustment, song start/stop and the VST instrument's parameters in your DAW software. This highly intuitive approach gives you hands-on control over your virtual studio—a level of control that a keyboard and mouse cannot match.

Remote-controlling the software

→ page 38

Global settings and data backup

While the Voice, Performance, and Multi modes provide controls for using and editing the programs of this instrument, the Utility mode is the place where you make overall settings for this instrument—for example, adjusting the transpose and fine tuning controls, or switching between MIDI and USB operation. You can also archive your important data created on this instrument to a USB storage device for safe-keeping.

Making global system settings

→ page 45

Backing up important data

→ page 47

Playing the Keyboard in the Voice mode

In the Voice Play display (the top display of the Voice Mode), you can select and play a single Voice. The Voices of this instrument are divided into the following two types:

Normal Voice

Normal Voices are mainly pitched musical instrument-type sounds (piano, organ, guitar, etc.) that can be played over the range of the keyboard.

Drum Voice

Drum Voices are mainly percussion/drum sounds that are assigned to individual notes. These Voices are used to perform rhythm parts.

This instrument features Banks for memorizing Voices. There are basically three different types of Banks: Preset, User, and GM. The contained Voices and features depend on the Bank as described below.

Preset Banks

The Preset Banks contain a full set of specially programmed Voices. Voices you've edited yourself cannot be saved in the Preset Banks.

User Banks

The User Banks contain the Voices you have edited and stored. These are picked up from Preset Voices by default.



CAUTION

If a Voice in a User Bank (User Voice) is overwritten or replaced, that User Voice will be lost. When you store an edited Voice, be careful not to overwrite any important User Voices.

GM Bank

The GM Bank contains the Voices allocated according to the GM standard.

GM Voice

GM (General MIDI) is a worldwide standard for Voice organization and MIDI functions of synthesizers and tone generators. It was designed primarily to ensure that any song data created with a specific GM device would sound virtually the same on any other GM device—no matter the manufacturer or the model. The GM Voice bank on this synthesizer is designed to appropriately play back GM song data. However, keep in mind that the sound may not be exactly the same as played by the original tone generator.

In the Voice mode, a total of 16 Banks (Preset Bank 1 – 8, User Bank 1 – 4, GM Bank, Preset Drum Bank, User Drum, GM Drum Bank) are available. Each of these Banks includes the Voices according to the Voice type. In the

Voice Play display, you can select the desired Voice from various Voice Banks and play it.

NOTE For details about the Voice, refer to "Basic Structure." For a list of the Preset Voices, refer to the separate Data List PDF file.

Selecting a preset Voice

1 Press the [VOICE] button.

This calls up the Voice Play display. (The [VOICE] button lamp lights.)

2 Select a Voice Bank with the BANK [DEC]/[INC] buttons.

In this condition, playing the keyboard sounds the Voice indicated in the display.

The parameters shown in the Voice Play mode are briefly explained below.

■ Voice Play display

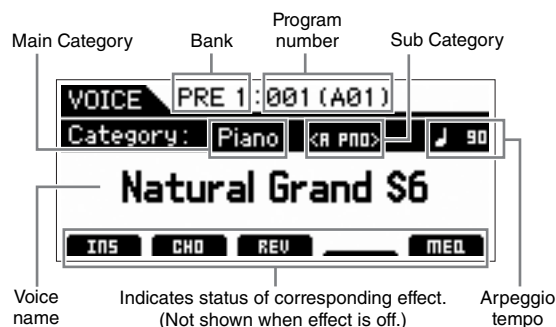

■ Normal Voice Banks

There are 13 different banks for the Normal Voices: PRE1 – 8 (Preset Banks), GM (GM Bank), USR1 – 4 (User Banks).

■ Drum Voices Banks

There are 3 different banks for the Drum Voices: PDR (Preset Drum Bank), GMDR (GM Drum Bank), UDR (User Drum Bank).

NOTE If the "Bank Wrap Around" parameter of the Utility General display is set to "on," you can change from the last Bank to the first Bank continuously.

3 Select a Voice with the data dial or [DEC]/[INC] buttons.

NOTE You can use the data dial or [DEC]/[INC] buttons to select the Voice number. This operation lets you call up Voices in subsequent or previous Banks.

NOTE To quickly move forward through the program (Voice) numbers in 10-step jumps, simultaneously hold down the [SHIFT] button and press the [INC] button in the Play display. To decrease by 10, do the opposite; simultaneously hold down the [SHIFT] button and press the [DEC] button.

4 Play the keyboard.

Using the Category Search function

The Voices are conveniently divided into specific Categories, irrespective of their bank locations. The categories are divided based on the general instrument type or sound characteristics. The Category Search function gives you quick access to the sounds you want.

1 Press the [CATEGORY SEARCH] button in the Voice Play display.

The Category Search dialog appears.

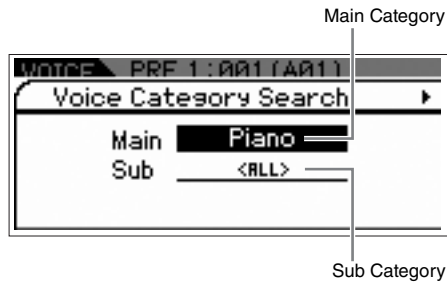

2 Move the cursor position to “Main” (Main Category) with the Cursor [▲] button, and use the data dial to select the Main Category.

3 Move the cursor position to “Sub” (Sub Category) with the Cursor [▼] button, and use the data dial to select the Sub Category.

4 Press the [ENTER] button, or Cursor [▶] button to actually call up the selected Category.

The Voice List of the selected category is shown.

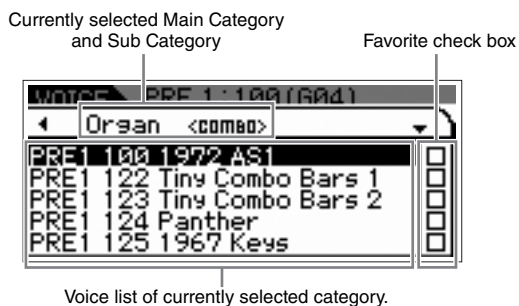

Voice list of currently selected category.

5 Select the Voice with the Cursor [▲]/[▼] buttons or data dial.

If you want to change the Category, press the Cursor [◀] button or [EXIT] button and go back to step 2.

6 Press the [ENTER] button to actually call up the Voice.

This closes the Category Search dialog.

Grouping your most-used Voices together—Favorite Category

Category Search also has a convenient Favorite Category that lets you collect your most often used and favorite Voices for easy selection. This is one more useful way you can quickly select the Voices you need from the huge number available on the instrument.

Registering your favorite Voices to the Favorite Category

1 Perform steps 1 through 4 of the “Using the Category Search Function” to call up the Voice List of the selected Category.

2 Press the Cursor [▶] button to move the cursor position to the Favorite check box column.

3 Select the desired Voice with the Cursor [▲]/[▼] buttons or data dial.

4 Press the [ENTER] button to place a check in the Favorite check box.

The checkmark will be entered in the box, and the selected Voice will be registered to the Favorite Category. To remove the checkmark from the box, press the [ENTER] button once again.

To register other Voices, repeat steps 3 through 4.



NOTE The Favorite Category is automatically stored immediately after checking the box.

5 When you complete registering Voices to the Favorite Category, press the [VOICE] button to return to the Voice Play display.

The Voice selected in the Category Search dialog is shown.

To register/remove the current Voice to/from the Favorite Category, simply hold the [SHIFT] button then press the [FAVORITE] button.

Selecting a Voice from the Favorite Category

- 1 Press the [FAVORITE] button in the Voice Play display.**
The list of Voices registered to the Favorite Category will be shown.
- 2 Select the Voice with the Cursor [▲]/[▼] buttons or data dial.**
- 3 Press the [ENTER] button to actually call up the Voice.**

Calling up the Simple Display

From the Voice Play display, you can call up the Simple Display by holding the [SHIFT] button then pressing the Cursor [◀]/[▶] buttons. This Simple Display shows the Voice name with a larger-than-normal character size. Three character types are available for selection.



Simple Display 1



Simple Display 2



Simple Display 3

Changing the tonal qualities of the Voice

Knobs 1 – 4 let you adjust a variety of parameters for the current Voice, such as effect depth, attack/release characteristics, timbre, and others. Five functions can be assigned to each Knob, alternatively selected via the Knob Function buttons.

- 1 Press the Knob Function buttons (located at the left of Knobs 1 – 4), repeatedly if necessary, so that the lamp corresponding to the desired functions lights.**

The Knob Select pop-up display will appear. In the pop-up display, the function currently assigned to the Knob and the current value of the function are shown.

To close the pop-up display, press the [EXIT] button.

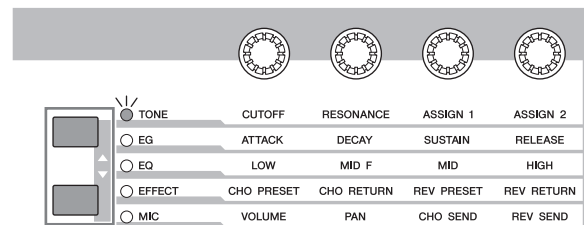

Knob Function buttons

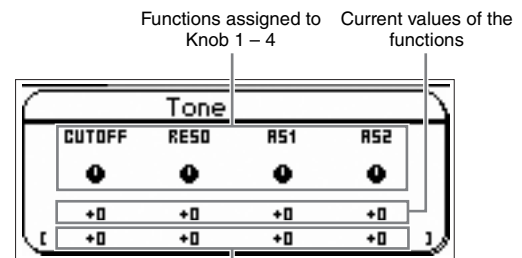

Unedited value (previously saved)

NOTE When the "Knob/Sldr Func Disp Sw" is set to "off" in the Utility General display, the Knob Select pop-up display will not be shown.

- 2 Turn a desired Knob while playing the keyboard.**

The Knob pop-up display will appear, and the function assigned to the Knob you're currently operating will affect the sound of the current Voice. The Knob pop-up display shows the function assigned to the Knob you're currently operating, the function value, and the "Original" value. The "Original" value indicates the unedited value (previously saved value) of the function assigned to the Knob.

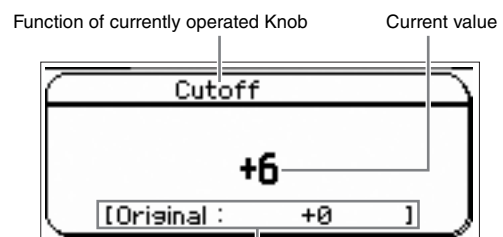

Unedited value (previously saved)

The Edit (E) Indicator

When changing the value of the parameter in the Voice/Performance/Multi Play or Edit display, the Edit Indicator will appear on the top right corner of the LCD. This gives a quick confirmation that the current Voice/Performance/Multi has been modified but not yet stored. To store the current edited status, follow the instructions.

Voice Editing

“Editing” refers to the process of creating a Voice by changing the parameters that make up the Voice. This can be done in Voice Edit, a sub mode within the Voice mode. The actual parameters that are available differ depending on the Voice type.

Normal Voice Edit

A Normal Voice (pitched musical instrument-type sounds) can consist of up to eight Elements. There are two types of Voice Edit displays: Common Edit, for editing the settings common to all eight Elements; and Element Edit, for editing individual Elements. In Element Edit, you can edit the parameters only on the S90 XS/S70 XS Editor.

NOTE The output level of the Element can be edited on the panel of this instrument. For further details, refer to “Adjusting the Element level.”

Drum Voice Edit

There are two types of Drum Voice Edit displays: Common Edit, for editing the settings that apply to all Drum keys in the Voice; and Element Edit, for editing individual keys (Elements). In Key Edit, you can edit the parameters only on the S90 XS/S70 XS Editor.

About Elements

An Element is the basic and the smallest unit for a Voice, and is created by applying various parameters (Effect, EG, etc.) to the waveform of the instrument sound. Each Voice of this instrument consists of several Elements.

Adjusting the Element level

- 1 Press the [EDIT] button in the Voice mode.
- 2 Press the Slider Function button a few times so that the lamp turns off.
- 3 Use Number [1] – [8] buttons to select the Element you want to edit.
- 4 Use the Slider to set the output level for the selected Element.

When any of the Number [1] – [4] buttons are selected, the levels of Elements 1 – 4 will be assigned to the Sliders 1 – 4. When any of the Number [5] – [8] buttons are selected, the levels of Elements 5 – 8 will be assigned.

Enhancing the sound with Effects

This instrument features a wide variety of Effects, letting you add reverb and chorus processing to the selected Voice for your keyboard performance. Simply changing the Effect type applied to the preset Voice lets you instantly come up with different sounds. The instructions below explain how to set the Effect type and the related parameters applied to the Preset Voice then store the settings as a User Voice.

- 1 Press the [VOICE] button to enter the Voice Play mode.
- 2 Select the Voice for which you wish to change or edit the Effect.
- 3 Press the [EDIT] button.

The Voice Edit Select display appears.



4 Move the cursor to “Effect” then press the [ENTER] button.

The Voice Edit Effect display appears.

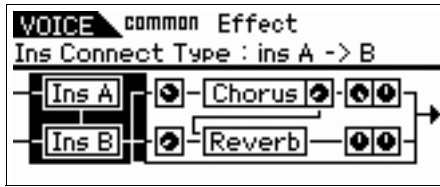

NOTE When the Arpeggio/Effect Function is set to “EFFECT ON/OFF,” the Voice Edit Effect display can be called up also by holding the [SHIFT] button and pressing the [INS] button simultaneously.

5 Move the cursor to “Ins A” then press the [ENTER] button.

The parameters of the current Effect are shown.

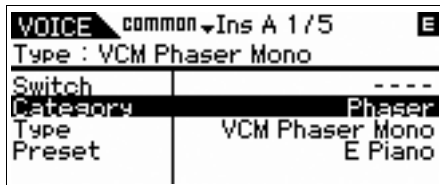
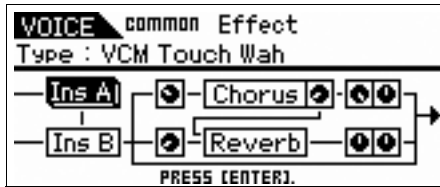

6 Move the cursor to “Category” then select the Category by using the data dial.

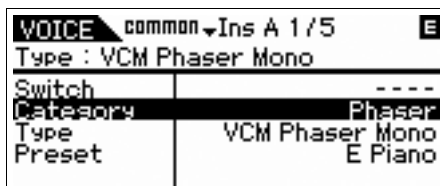

7 Move the cursor to “Type” then select the Effect Type by using the data dial.

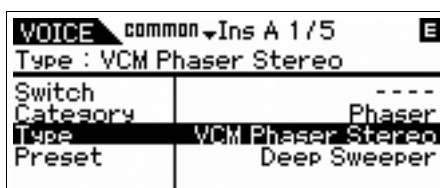

8 Move the cursor to “Preset” then select the Preset by using the data dial.

The Preset includes the typical settings of parameters for the currently selected Effect Type. Try out several Presets so that you can find how each Effect affects the sound.

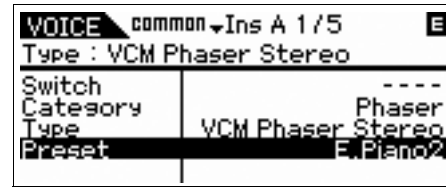

9 If desired, set each of the parameters.

Try narrowing in on your desired sound by finely editing the parameters provided for each Effect Type.

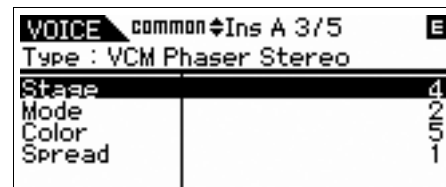
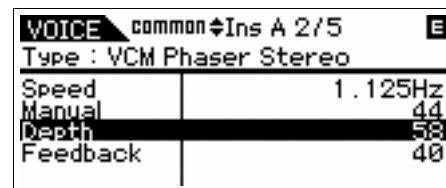

10 After setting the parameters, press the [STORE] button to store your settings as a User Voice.

If you edit the preset Voice, your editing will be stored as a User Voice.



11 Select the destination memory by using the data dial, press the [ENTER] button to call up the confirmation message, then press the [ENTER] button again.

NOTE Perform the same operations as above if you want to edit the Insertion B Effect.

Using the Arpeggio function

The Arpeggio function automatically triggers preset arpeggio phrases, riffs, and rhythmic patterns according to the notes you play.

It not only provides inspiration and full rhythmic passages over which you can perform, it gives you quality MIDI data you can use in creating songs, or fully formed backing parts to be used in your live performances. You can assign the desired five Arpeggio Types to each Voice. You can also assign the desired five Arpeggio Types to each Part of each Performance/Multi and play back the Arpeggios of up to four Parts simultaneously. You can also set the Arpeggio playback method, Velocity range and Play Effects to create your own original grooves. What's more, Arpeggio playback can be transmitted through the MIDI Out, letting you record the Arpeggio data to a sequencer.

Transmitting Arpeggio playback as MIDI data

The Arpeggio phrase can be transmitted as MIDI data by setting the following parameters to on:

■ Voice Arpeggio

Voice mode → [UTILITY] → select "Voice" in the Utility Select display → [ENTER] → select "Arpeggio" in the Utility Voice Select display → [ENTER] → "Arp MIDI Out Sw"

■ Performance Arpeggio

Performance mode → [EDIT] → select the Part in the Performance Edit Select display → [ENTER] → select "Arpeggio" in the Performance Part Edit Select display → [ENTER] → select "Arp Edit" in the Arp Select display → [ENTER] → "Arp MIDI Out Sw"

■ Multi Arpeggio

Multi mode → [EDIT] → select a Part on the Multi Edit Select display → [ENTER] → select "Arpeggio" on the Multi Part Edit Select display → [ENTER] → select "Arp Edit" on the Arp Select display → [ENTER] → "Arp MIDI Out Sw"

NOTE The transmit channel for Arpeggio can be set at the "Arp Transmit Ch" parameter in the same display as "Arp MIDI Out Sw."

Arpeggio types

This instrument features 6,779 Arpeggio types (in 18 categories) including Synthesizer, Piano, Guitar, Guitar bass, Strings, Drum, etc.

Turning the Arpeggio On/Off

To turning Arpeggio playback on or off, press the [ARP ON/OFF] button on the panel.

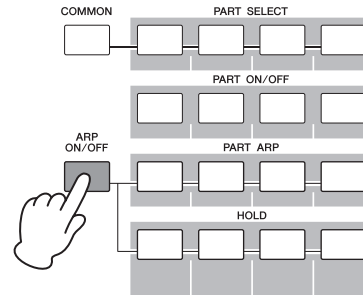

Selecting the Arpeggio Type

- 1 Press the [EDIT] button in the Voice mode.
- 2 Select "Arpeggio" then press the [ENTER] button.
- 3 Select "Arp Select" by using the cursor buttons then select one of the Arp 1 – 5 settings by using the data dial.



- 4 Select "Arp 1 – 5 Type" by using the cursor buttons then press the [ENTER] button.

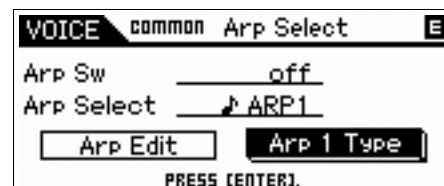

- 5 Find the favorite pattern by changing the Main Category/Sub Category/Type by using the data dial.

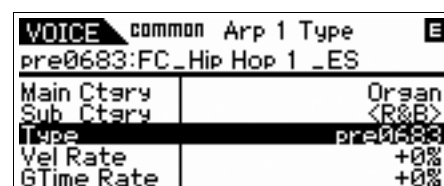

- After finding the favorite pattern, press the [STORE] button to store the setting as a User Voice.

Copying the Arpeggio Type to another Arpeggio part

Follow the instruction to copy the Arpeggio Type assigned to the Arp 1 to the Arp 2 – 5.

- Select “ARP SELECT” by pressing the Arpeggio/Effect Function button.
- Press the Function [1] button.
- Press one of the Function [2] – [5] buttons while holding down the [STORE] button.

Changing the Arpeggio type

To change the Arpeggio from five types, use the Arpeggio/Effect Function button and Function button.

Arpeggio/Effect Function button

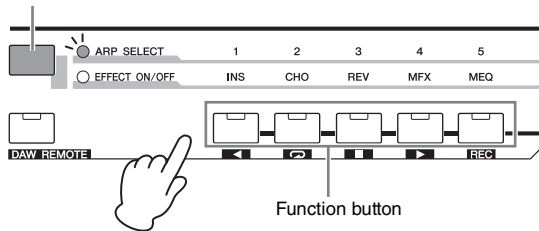

- Press the [ARP ON/OFF] button on the panel to turn the Arpeggio on.
- Select “ARP SELECT” by pressing the Arpeggio/Effect Function button.
- Change the Arpeggio type by using the Function button.

Creating a New Performance by Using Your Favorite Voice (Performance Creator)

This instrument features a convenient Performance Creator function which lets you create a new Performance by using favorite Voices you've found in the Voice mode. This function lets you copy parameter settings associated with the Voice (such as Effects) to the Performance—allowing you to quickly and easily come up with precisely the sound you want. Performance Creator provides three convenient features: Layer, Split, and Drum Assign.

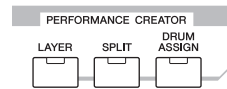

Layer—Playing different Voices together

This section explains how to create a Performance in which different Voices are layered together across the keyboard. By creating such a Performance, you can play a rich, thick sound of a layered piano and strings, for example.

- 1 Select a Voice in the Voice mode.



- 2 Press the [LAYER] button on the panel.

The Category Search display appears.

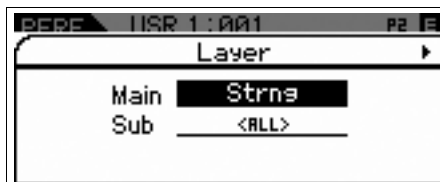

- 3 Select the Category including the Voice you want to layer then press the Cursor [▶] button.

The Voice list is shown.



- 4 Select the desired Voice from the list, then press the [ENTER] button.

The Performance Play display will appear.



- 5 Press the [STORE] button to store the settings as a Performance.



NOTE When you press the [EDIT] button in the Store display, you can check the sound of the Performance at the storing destination.

Split—Playing two different Voices with your left and right hands

This section shows you how to create a Performance in which the keyboard is divided into two sections—the left-hand section and the right-hand. The highest note of the left-hand section is referred to as the “Split Point.” By creating such a Performance, you can play a bass part with your left hand, and a piano part with your right, for example.

1 Select a Voice in the Voice mode.



2 Press the [SPLIT] button on the panel.

The Split display appears.



3 Move the cursor to “SPLIT POINT” then set the Split Point.



You can determine the Split Point by holding the [SHIFT] button then pressing the desired note on the keyboard.

NOTE The note set to the Split Point is included in the upper section of the keyboard.

4 Move the cursor to “LO/UP” then select whether the desired Voice is assigned to the lower section or the upper section of the keyboard.

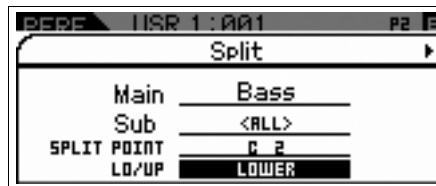

NOTE When the original Voice is a Drum Voice, the Split Point of the original Drum Voice is not changed even if LO/UP is set.

5 Move the cursor to “Main”/“Sub” then select the Category that includes your desired Voice.



6 Press the Cursor [▶] button.

The Voice list is shown.



7 Select the desired Voice from the list, then press the [ENTER] button.

The Performance Play display will appear.



8 Press the [STORE] button to store the settings as a Performance.

Drum Assign—Layering a drum Part with the current Voice

This section explains how to create a Performance in which you can trigger a drum pattern (via the Arpeggio function) in addition to the current Voice.

- 1 Select a Voice in the Voice mode.



- 2 Press the [DRUM ASSIGN] button on the front panel.

The Drum Assign display appears. The Dr/Pc (Drum/Percussion) is automatically assigned to the Category. The Drum Voice is assigned to Part 4 then the Arpeggio is automatically turned on. Play the keyboard to trigger the Arpeggio.

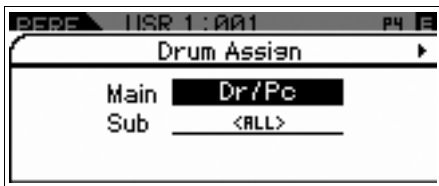

- 3 Press the Cursor [▶] button.

The Voice list is shown.



- 4 Select the desired Drum Voice from the list, then press the [ENTER] button.

The Performance Play display will appear.



Changing the drum pattern (Arpeggio Type)

Executing the Drum Assign function will assign the Drum Voice to Part 4 and set the Arpeggio of Part 4 to on. If you want to change the drum pattern, select a different Arpeggio Type in the Performance Part Edit.

- 5 Press the [EDIT] button in the Performance Play display.

The Performance Edit Select display appears.

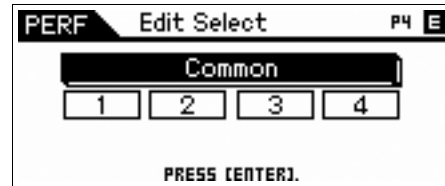

- 6 Select Part 4 by using the cursor buttons then press the [ENTER] button.

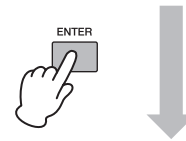
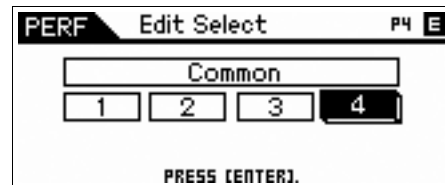

- 7 Select "Arpeggio" by using the cursor buttons then press the [ENTER] button.



- 8 Select "Arp 1 Type" by using the cursor buttons then press the [ENTER] button.

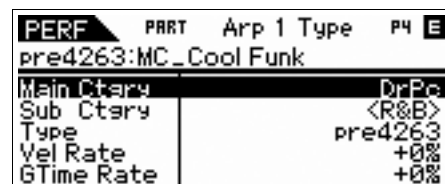

- Find your favorite pattern by changing the Main Category/Sub Category/Type with the data dial.

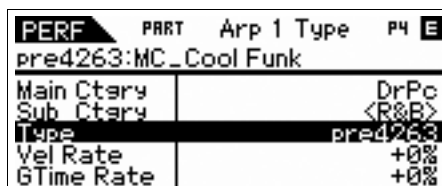

You can change the pattern of the Arp 2 – 5 via the same operation. To change the Arpeggio from among the five types, use the Function button. Turn “ARP SELECT” on by pressing the Arpeggio/Effect Function button then press the Function button.

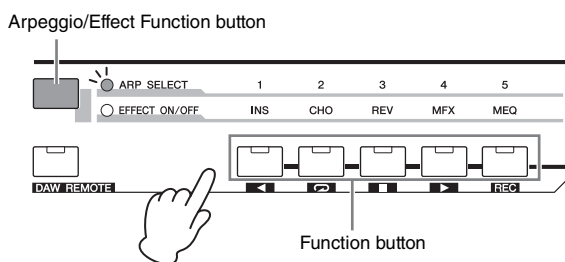

Assigning a name to the Performance

You can assign the name to the Voice and Performance then store the settings as a User Voice/Performance.

- Press the [EDIT] button in the Performance Play display.

The Performance Edit Select display appears.

- Select “Common” by using the cursor buttons then press the [ENTER] button.

- Select “Name” by using the cursor buttons then press the [ENTER] button.

- Press the [ENTER] button with “Name” selected.

The Naming dialog appears.



- Select the desired character by using the data dial and cursor buttons then press the [INC] button to enter the selected character. To cancel the selected character, press the [DEC] button.

You can enter up to 20 alphanumeric characters.

- After entering the characters, press the [ENTER] button.

- Press the [STORE] button.

The destination User Banks and Programs are shown.



- Select the desired Bank and Program then press the [ENTER] button.



- After the confirmation dialog appears, press the [ENTER] button.

NOTE When you press the [EDIT] button in the Store display, you can check the sound of the Voice/Performance/Multi at the storing destination.

Playing the Keyboard in the Performance Mode

Selecting a Performance

Selecting a Performance is done in basically the same way as selecting a Voice. The Category Search function is available also in the Performance Play mode. Note that the S90 XS/S70 XS has no Preset Performances and provides only three User Banks.

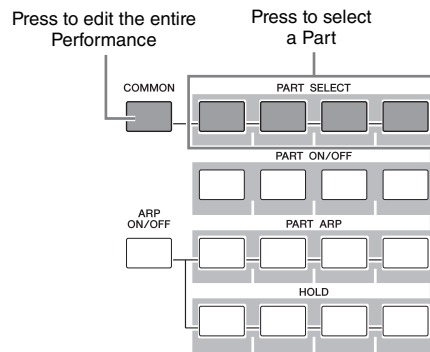

Changing the timbre of the Voice

Just as in the Voice mode, the sound of the Performance (consisting of a maximum of four Parts or Voices) can be edited via the Knobs and Sliders in the Performance mode. There are two ways to edit the Performance: editing the entire Performance, and editing only one specific Part (Voice) assigned to the Performance. The Part to be edited is selected via the Performance Control buttons. To edit the entire Performance, press the [COMMON] button then turn the Knob. To edit a specific Voice of the current Performance, select the desired Part by using the [PART SELECT] buttons then turn the Knob.

NOTE Hold the [SHIFT] button and press the [COMMON]/[PART SELECT] button to call up the Common Edit Select display/Part Edit Select display. This is useful for editing the Performance.

The far left four Sliders adjust the Volume, Pan, Chorus Send and Reverb Send for each of the four Parts. Select the function via the Slider Function button, then move the Sliders.

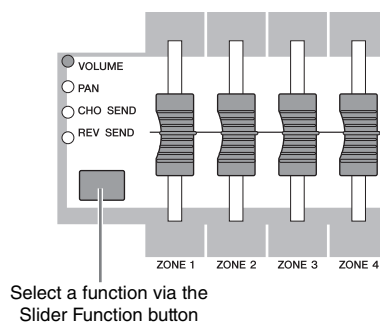

Singing with a Connected Microphone

By connecting a microphone to the MIC INPUT jack (combo jack) located on the rear panel of this instrument, you can enjoy singing along with your own performance. You can also apply the built-in Effects to this signal input via the MIC INPUT jack, including the distinctive Vocoder Effect. The example below assumes you want to sing while playing the keyboard.

1 Connect the microphone to the MIC INPUT jack on the rear panel.

2 Press the [MIC ON/OFF] button on the panel so that the lamp lights.

3 Adjust the microphone input level by using the INPUT GAIN knob.

Adjust the input gain so that the PEAK lamp flashes briefly.

4 Select “MIC” by pressing the Knob Function buttons then adjust the volume by using the Knob to which VOLUME is assigned.

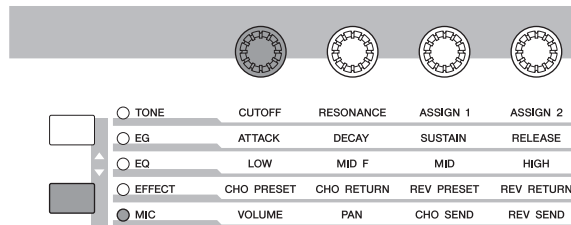

5 As necessary, control the Knobs to which the PAN, CHORUS SEND and REVERB SEND are assigned.

Recording/Playing Back with a USB Storage Device (Audio Record/Play Mode)

The Audio Record/Play mode lets you record your keyboard performance as audio data. The recorded audio data will be saved as an audio file to the root directory of the external USB storage device or internal flash memory, allowing you to play back the audio file from the specified storage.

Recording

In this section, you'll learn how to record your keyboard performance as a stereo Wave file (of 44.1kHz/16-bit). Your keyboard performance can be recorded for up to 74 minutes at a fixed recording level. The instructions below explain how to record your keyboard performance to a USB storage device.

1 Press the [AUDIO REC/PLAY] button.

The Audio Rec/Play Select display will appear.



2 Select "Rec" then press the [ENTER] button.

The Standby display will appear.

3 Move the cursor to "Rec Storage" then select the USB storage device as the target ("usb1-1" in the example here) by using the data dial or [DEC]/[INC] button.

NOTE The "internal" setting indicates the internal flash memory.



4 Move the cursor to "Trigger Level" then adjust the Trigger Level.

As soon as the signal level (set here) of your keyboard performance or MIC INPUT exceeds the trigger level, recording will begin. For best results, set this as low as possible to capture the entire signal from the very beginning, but not so low as to record unwanted noise. In this example, set the Trigger Level to "10."



5 Press the [ENTER] button.

The Recording Standby display appears.



6 Play the keyboard.

Recording actually starts as soon as the signal of your keyboard performance exceeds the Trigger Level set in step 4.



7 Press the [ENTER] button after your performance is finished.

8 Press the [ENTER] button when the “Save Audio Rec file?” message appears.

Your performance is saved as an audio file to the root directory of the USB storage device.

Completing the save operation calls up the Audio Play display.

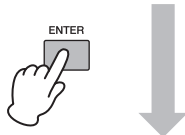

Playing back the recording

Now that you've recorded the audio of your keyboard performance, try playing back the file.

1 From the Audio Play display, select the desired file by moving the cursor using the Cursor [▲]/[▼] buttons.

The audio files you record are named in numeric order (“000.wav,” “001.wav,” etc.).



2 Press the [ENTER] button.

The audio file will begin playing.

3 Adjust the volume via the data dial or [DEC]/[INC] buttons.

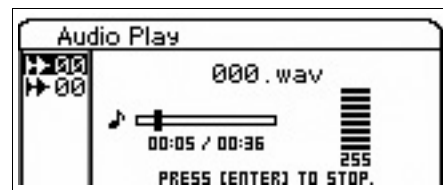

4 Press the [ENTER] button to stop playback.

Pressing the [ENTER] button again starts playback from that point.

5 Press the [EXIT] button to go back to the file select display.

6 If you want to record additional performances, hold the [SHIFT] button then press the [AUDIO REC/PLAY] button.

Using a Connected Computer

By connecting this instrument to a computer, you can take advantage of the following functions and applications.

- External tone generator for DAW software and MIDI keyboard
- Remote Controller of the DAW software
- More detailed Voice Editing from the computer (S90 XS/S70 XS Editor)

Connecting to a computer

The USB cable and USB-MIDI Driver are necessary to connect the S90 XS/S70 XS to the computer. Follow the instructions below. Note that the MIDI data can be transmitted through a USB cable.

NOTE Since the S90 XS/S70 XS has no built-in speakers, you'll need an external audio system or a set of stereo headphones to properly monitor it. For details, refer to "Setting Up" on page 16.

1 Download the USB-MIDI Driver from our website.

After clicking the Download button, extract the compressed file.

http://www.global.yamaha.com/download/usb_midi/

NOTE Information on system requirements is also available at the above web site.

NOTE The USB-MIDI Driver may be revised and updated without prior notice. Make sure to check and download the latest version from the above site.

2 Install the USB-MIDI Driver to the computer.

For instructions on installing, refer to the online Installation Guide included in the downloaded file package.

When connecting this instrument to a computer in the Installation procedure, connect the USB cable to the USB TO HOST of this instrument and the USB terminal of the computer as shown below.

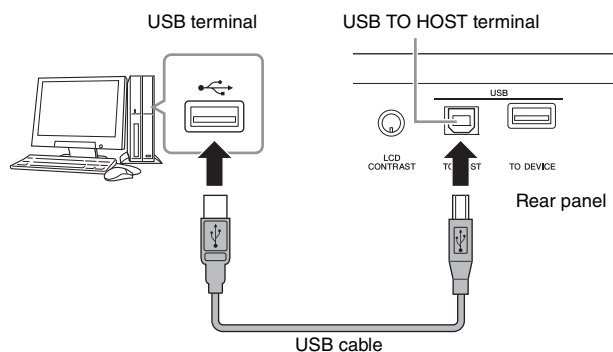

3 Make sure that the USB TO HOST terminal of this instrument is enabled.

Press the [UTILITY] button to call up the Utility mode, select "MIDI" via the Cursor button then press the [ENTER] button to call up the MIDI display. Set the MIDI In/Out parameter to "USB."

Utility MIDI 1/3	
Local Control	on
Keyboard Transmit Ch	1
Basic Receive Ch	1
MIDI In/Out	USB
MIDI Sync	auto
Clock Out	on

4 Press the [STORE] button to store this setting.

Precautions when using the USB TO HOST terminal

You must observe the following points when connecting the S90 XS/S70 XS to your computer via the USB TO HOST connector.

Failure to do so can cause the instrument and/or the computer to hang up (freeze), possibly causing corruption or loss of data. If the computer or S90 XS/S70 XS freezes, turn the power to the S90 XS/S70 XS off and then on, then restart the computer.

- Before connecting the computer to the USB TO HOST terminal, exit from any power-saving mode of the computer (such as suspended, sleep, standby).
- Before turning on the power to the instrument, connect the computer to the USB TO HOST connector.
- Execute the following before turning the power to the instrument on/off or plugging/unplugging the USB cable to/from the USB connector.
 - Quit any open applications (such as S90 XS/S70 XS Editor and sequencer software).
 - Make sure that data is not being transmitted from the instrument. (Data is transmitted only by playing notes on the keyboard or playing back a song.)
- Leave an interval of at least six seconds between powering the S90 XS/S70 XS on and off, or between disconnecting and connecting the USB cable.

MIDI channels and MIDI ports

MIDI data is assigned to one of sixteen channels, and this synthesizer is capable of simultaneously playing sixteen separate Parts, via the sixteen MIDI channels. However, the sixteen-channel limit can be overcome by using separate MIDI “ports,” each supporting sixteen channels. While a single MIDI cable is equipped to handle data over up to sixteen channels simultaneously, a USB connection is capable of handling far more—thanks to the use of MIDI ports. Each MIDI port can handle sixteen channels, and the USB connection allows up to eight ports, letting you use up to 128 channels (8 ports x 16 channels) on your computer. When connecting this instrument to a computer using a USB cable, the MIDI ports are defined as follows:

■ Port 1

The tone generator block in this instrument can recognize and use only this port. When playing the S90 XS/S70 XS as a tone generator from the external MIDI instrument or computer, you should set the MIDI Port to 1 on the connected MIDI device or computer.

■ Port 2

This port is used to control the DAW software on the computer from the S90 XS/S70 XS by using the Remote Control feature.

■ Port 3

This port is used as the MIDI Thru Port. The MIDI data received over Port 3 via the USB TO HOST terminal will be re-transmitted to an external MIDI device via the MIDI OUT terminal. The MIDI data received over Port 3 via the MIDI IN terminal will be re-transmitted to an external device (computer, etc.) via the USB TO HOST terminal.

■ Port 4

This port is used only for data communication of the S90 XS/S70 XS Editor. No other software or device can use this port.

■ Port 5

This port is used only for data communication of the S90 XS/S70 XS Remote Editor. No other software or device can use this port.

When using a USB connection, make sure to match the MIDI transmit port and the MIDI receive port as well as the MIDI transmit channel and the MIDI receive channel. Make sure to set the MIDI port of the external device connected to this instrument according to the above information.

Using as a multi-timbral tone generator (Multi mode)

The instructions below show how to use this instrument as a MIDI tone generator. In this case, actual MIDI sequence data is transmitted from a DAW or sequencer on the computer, allowing you to avoid using software synths and save processing power on your computer.

Setting up the S90 XS/S70 XS

- 1 Press the [MULTI/SEQ PLAY] button to enter the Multi mode.**
- 2 Select a Multi to be edited.**
- 3 Press the [MIXING] button to call up the Mixing display.**
- 4 Set up the Mixing for parts 1 – 16 as necessary.**

From the Mixing display, you can select the Voice and set various parameters such as pan, volume, balance between the chorus/reverb and dry sound, insertion effect on/off and arpeggio on/off. For more detailed editing of the Voices, use the Multi Part Edit display.

Setting up the DAW of the computer

- 1 Set the MIDI output port of the tracks (for playing via the tone generator of the S90 XS/S70 XS) to USB Port 1.**
- When connecting via USB, enter the checkmark to “Yamaha S90 XS (S70 XS)-1” or “Yamaha S90 XS (S70 XS) Port1.”
- 2 Enter the MIDI data to each track of the DAW on the computer.**

The tone generator settings of the part corresponding to the MIDI track will be set in the Mixing mode on the S90 XS/S70 XS.

NOTE By using the S90 XS/S70 XS Editor, you can create your original Mixing setup of the S90 XS/S70 XS from your computer. The created Mixing setup can be saved as a file for future recall.

Remote-controlling the software (Remote mode)

The S90 XS/S70 XS features a highly convenient Remote mode which lets you control the DAW software and software synthesizer on your computer via the panel operations of the S90 XS/S70 XS. For example, you can start/stop playback of the DAW software on the computer by using the Function buttons and control the song position on the DAW software by using the data dial, [INC] and [DEC] buttons instead of using the mouse or keyboard of the computer.

The DAW applications Cubase, Logic Pro, SONAR and Digital Performer can be controlled by the Remote Control mode of the S90 XS/S70 XS. Up to 50 Control Templates of the VST Instruments can be stored on the internal memory of this instrument. Use the S90 XS/S70 XS Remote Editor for editing the Control Template.

NOTE The S90 XS/S70 XS Remote Editor is installed by installing the S90 XS/S70 XS Remote Tools. The S90 XS/S70 XS Remote Tools consists of two components: S90 XS/S70 XS Remote Editor and S90 XS/S70 XS Extension, which enables you to use the S90 XS/S70 XS along with Cubase series 4.5 or later.

S90 XS/S70 XS Remote Tools can be downloaded from Yamaha web site:
<http://www.yamahasynth.com/download/>

Here explains how to control the DAW software from the S90 XS/S70 XS.

Computer software that can be controlled from the S90 XS/S70 XS

Cubase, SONAR, Logic Pro, Digital Performer

For the most recent information, refer to the following URL:
<http://www.yamahasynth.com/>

Setting up for Remote Control

NOTE Before making the setup of DAW Remote, make sure to install the USB-MIDI Driver and the S90 XS/S70 XS Remote Tools correctly.

Setting up the S90 XS/S70 XS

- 1 Connect this instrument to the computer via a USB cable (page 36).
- 2 Press the [DAW REMOTE] button to enter the Remote mode.
- 3 Press the [UTILITY] button to call up the Remote display of the Utility mode.

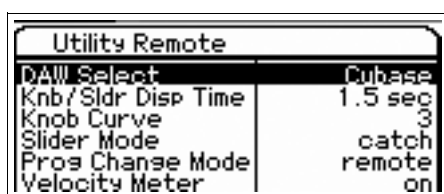

- 4 Set the “DAW Select” to the desired DAW.
- 5 Press the [STORE] button to store this setting.
- 6 Start the DAW software on the computer connected to this instrument.

Setting up the DAW of the computer

This section explains how to set up after starting each application.

NOTE When the cable between the S90 XS/S70 XS and the Windows computer is disconnected or the S90 XS/S70 XS is turned off accidentally, the DAW will not recognize the S90 XS/S70 XS again even if you connect the cable again or turn the S90 XS/S70 XS on. If this occurs, exit the DAW software, then restart it after setting up the S90 XS/S70 XS and making sure the connection is secure.

Cubase

The settings will be completed by installing S90 XS/S70 XS Remote Tools.

SONAR

- 1 Pull down the [Options] menu and select [MIDI Devices] to call up the “MIDI Devices” window.
- 2 Add “Yamaha S90 XS (S70 XS)-2” to the Input Device, then add “Yamaha S90 XS (S70 XS)-2” to the Output Device.
- 3 Pull down the [Options] menu and select [Control Surfaces] to call up the Control Surface window.
- 4 Click the [+] button, select “Mackie Control,” then set the Input Port to “Yamaha S90 XS (S70 XS)-2” and set the Output Port to “Yamaha S90 XS (S70 XS)-2.”

Digital Performer

- 1 In the Audio/MIDI setup of a Macintosh computer, connect Port 2 of the interface of the S90 XS/S70 XS to Port 2 of the tone generator. When there is only one Port for the tone generator, add the new Port, then connect it to the interface.
- 2 Pull down the [Setup] menu and select [Control Surfaces] to call up the Control Surface window.
- 3 Click the [+] button.
- 4 Select “Mackie Control” in the Driver section.
- 5 In the box for setting “Unit” and “MIDI,” select “Mackie Control” in the “Unit” section and select “S90 XS (S70 XS) New Port 2” in the “MIDI” section.

Logic Pro

- 1 Select the [Preference] menu → [Control Surfaces] → [Settings] to call up the Settings window.
- 2 Select the [New] menu → [Install].
- 3 Select “Mackie Control” in the model, then add it as a control surface.
- 4 Set the MIDI Output Port to “Yamaha S90 XS (S70 XS)-2.”
- 5 Set the MIDI Input Port to “Yamaha S90 XS (S70 XS)-2.”

NOTE Mackie Control is the trademark of Mackie Designs, Inc.

NOTE For details about the button operations and functions, refer to the separate PDF manual.

Editing a Control Template

Use the S90 XS/S70 XS Remote Editor for editing the Control Template.

The S90 XS/S70 XS Remote Editor can be downloaded from the following URL:
<http://www.yamahasynth.com/download/>

For instructions on using the S90 XS/S70 XS Remote Editor, refer to the PDF manual included with the software.

Editing more detailed parameters of the Voice

About the S90 XS/S70 XS Editor

The S90 XS/S70 XS Editor lets you edit Mixing setups and Mixing Voices in the Multi mode of the S90 XS/S70 XS from your computer, giving you even greater editing convenience. Furthermore, the data edited on the S90 XS/S70 XS is always synchronized with the data on the computer (S90 XS/S70 XS Editor) and vice versa. This provides a smooth, seamless interface, making it exceptionally easy to create and edit data.

Using the S90 XS/S70 XS Editor

Using the S90 XS/S70 XS Editor on Cubase

The S90 XS/S70 XS Editor works as a VST3 plug-in software on Cubase. In this case, you can launch the S90 XS/S70 XS Editor via the same operations as that any other VST Instrument.

Using as a stand-alone editor

In addition, Yamaha provides a stand-alone version of the S90 XS/S70 XS Editor which works as a client of the host Studio Manager. Studio Manager V2 is a cross-platform application that enables you to start multiple Editors for controlling Yamaha hardware products remotely, and lets you save multiple Editor settings. To use the S90 XS/S70 XS Editor, start Studio Manager V2 then start the S90 XS/S70 XS Editor as a plug-in software within Studio Manager V2.

The Studio Manager V2 and S90 XS/S70 XS Editor can be downloaded from the following URL:
<http://www.yamahasynth.com/download/>

For instructions on using the Studio Manager and S90 XS/S70 XS Editor, refer to the respective PDF manuals included with the software.

Playing the Keyboard Along with Playback of the MIDI File

The Multi mode/Sequence Play mode should be used when you want to play the keyboard along with playback of the MIDI file. This instrument is equipped with a 16-track sequencer for playback, allowing you to play back MIDI data of up to 16 tracks.

Before executing the instructions below, prepare the MIDI file (via DAW software or other means) then save it to a USB storage device. You should also create an appropriate Multi for playback.

- 1 Connect the USB storage device including the MIDI files to the USB TO DEVICE terminal on the rear panel of this instrument.

- 2 Press the [MULTI/SEQ PLAY] button a few times to enter the Sequence Play mode.

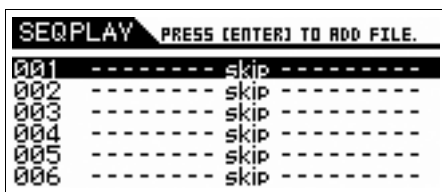

- 3 Select the Chain Step 001 then select the desired Multi for playback of the MIDI file by using the data dial and the [DEC]/[INC] buttons.

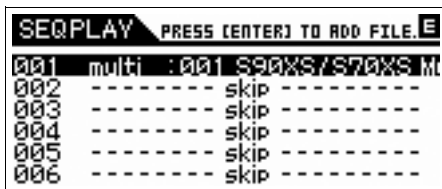

- 4 Move the cursor to Chain Step 002 by using the cursor buttons then press the [ENTER] button.

The File Load display appears.

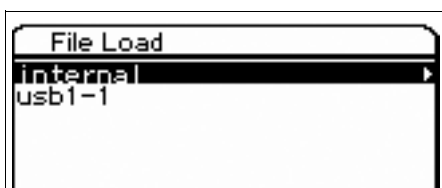
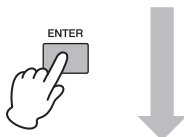
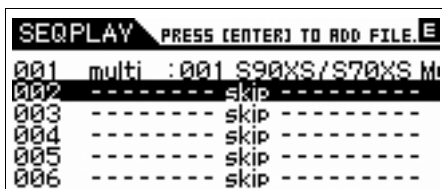

- 5 Select the USB storage device path ("usb1-1" in this example) then press the [ENTER] button.

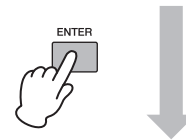
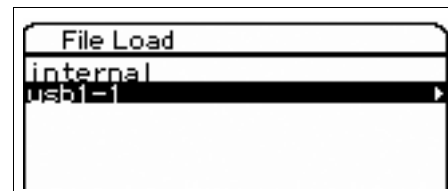

- 6 Select the desired MIDI file then press the [ENTER] button.

- 7 Press the [ENTER] button after the display for selecting the Sequence Chain Step number is shown.



- 8 Press the [ENTER] button again after the confirmation display is shown.

- 9** Press the [EXIT] button a number of times to go back to the Sequence Play mode.

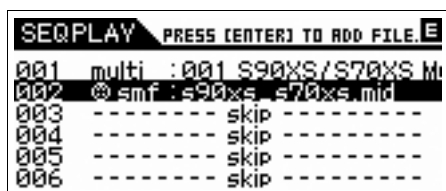

Audio file selection can be done via the same operation.

- 10** Move the cursor to the Chain Step 003 by using the cursor buttons then select “end” by using the data dial and [DEC]/[INC] button.

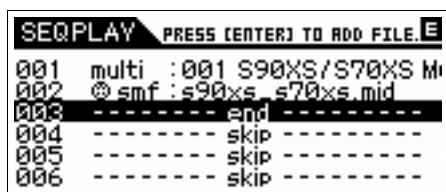

- 11** Select the Part for your keyboard performance by pressing one of the [1] – [16] buttons.
- 12** Move the cursor to Chain Step 001 by using the cursor buttons then press the [START/STOP] button to start playback.
 The Multi setup recorded to Step 001 will be called up then the MIDI file will be started.
- 13** Play the keyboard.

Using as a Master Keyboard (Master Mode)

The Master mode lets you:

- Create and store up to 128 programs, each containing a Voice, a Performance or a Multi, and of which can be instantly called up for use.
- Assign up to four separate Zones in each Master program for use as a master keyboard.

You can use the Master mode to memorize the settings you use most often including the information on which mode is used, and call up these settings instantly anytime you need them with a single button press. Furthermore, you can memorize the settings for controlling an external MIDI device by the Master, allowing you to change and control the connected external MIDI tone generator in sequence while performing live.

Storing the Edited Voice/ Performance/Multi

It is a good idea to assign the Voice mode to one Master program number (for example, 001) and the Performance mode to the next numbered program (i.e., 002) if you want to quickly call up a specific Voice then a related specific Performance. Follow the steps below to store the program.

1 Press the [MASTER] button to enter the Master mode.

2 Select a Master to be edited.

The Master Play display appears.

3 Press the [EDIT] button.

The Master Edit Select display appears.



4 Select “Common” then press the [ENTER] button.

The Common Edit display appears.



5 Select “Memory” by using the cursor buttons then press the [ENTER] button.

The Common Memory display appears.

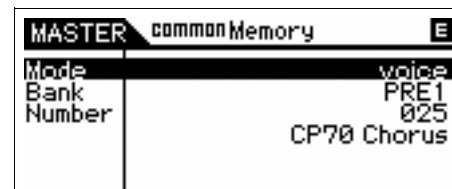

6 At the “Mode” parameter, select “voice,” “performance” or “multi.”

7 Select the desired program by setting the Bank and Number.

8 Press the [STORE] button to execute the Store operation.

Making settings for use as a master keyboard

It is a good idea to memorize the master keyboard function to the Master when using external multiple MIDI tone generators. Simply by selecting a different Master, you can change the programs in your connected external MIDI tone generators. Here's how to do it:

1 Press the [MASTER] button to enter the Master mode.

2 Select a Master to be edited.

3 Press the [EDIT] button.

The Master Edit Select display appears.



4 Select “Common” then press the [ENTER] button.

The Common Edit display appears.



5 Select “Zone Sw” then press the [ENTER] button.

The Common Zone Switch display appears.

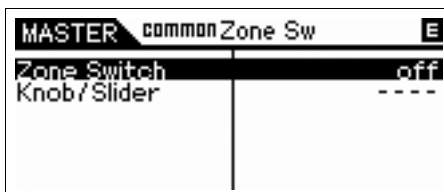

6 Set “Zone Switch” to “on.”

The “Knob/Slider” parameter also will be set to on automatically.

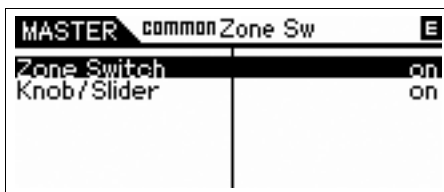

NOTE When using the Knobs/Sliders as the controller of the Knob Function/Slider Function, set the Knob/Slider to off.

7 Press the [EXIT] button twice to return to the Master Edit Select display.



8 Select “Zone 1” by using the cursor buttons then press the [ENTER] button.

The Zone Edit Select display appears.



9 Make the settings of the Zone 1 in the respective Transmit, Note, Preset and Knob/Slider displays.

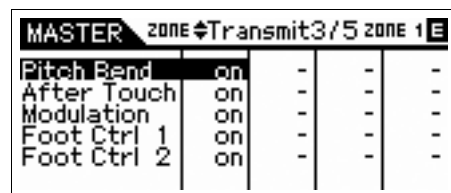

Transmit display

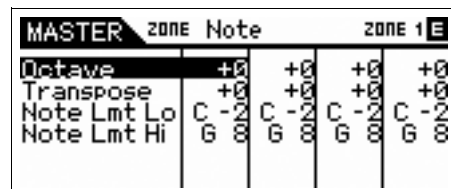

Note display

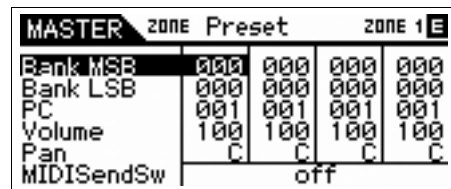

Preset display

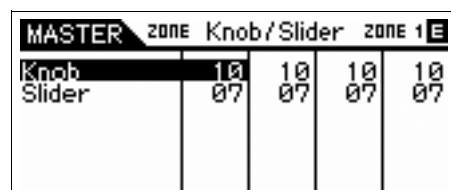

Knob/Slider display

10 Press the [EXIT] button to return back to the Master Edit Select display, then set the other Zone using this same operation.

11 After setting all the desired parameters, press the [STORE] button to store your settings as a Master program.

After completing these settings, assign a name to the Master in the “Name” parameter of the Master Common Edit display. After naming, press the [STORE] button to store the Master.

Making Global System Settings (Utility Mode)

In the Utility mode, you can set parameters that apply to the entire system of this instrument. To enter the Utility mode, press the [UTILITY] button. Pressing the [EXIT] button returns to the original display. This section describes some useful functions in the Utility mode.

Setting the default mode when turning the power on

General → Power on Mode

From the Voice, Performance, Multi and Master, the mode specified here is called up when turning the power on.

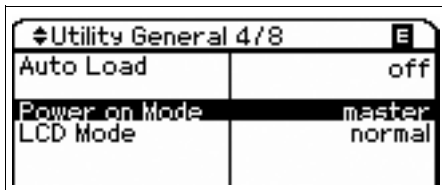

Reversing the LCD status

General → LCD Mode

This parameter determines the LCD status.



When "normal" is selected:



When "reverse" is selected:

Click (metronome) settings

General → Click Sw – OutputSel

Determines the tempo, volume and output destination of the click (metronome).

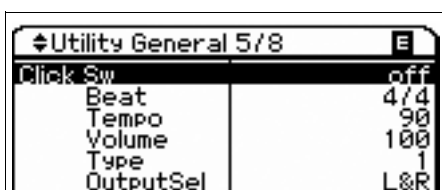

Micro Tuning

MicroTune

Tunes the individual notes of the keyboard.



Effect settings applied to the signal input from the MIC INPUT jack

Voice → A/D FX

Determines the Effect settings and Vocoder settings applied to the signal input from the MIC INPUT jack in the Voice Mode.

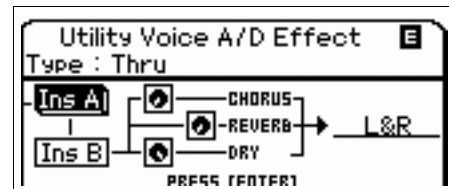

NOTE For details on how to apply the Insertion Effect, refer to page 24.

Master Effect/Master EQ settings in the Voice mode

Voice → Master FX, Master EQ

Determines how much of the Effect and EQ processing is applied to the master output.

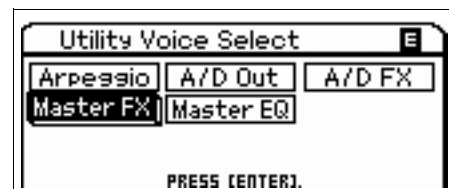

Changing the panel lock settings

Panel Lock

Determines the buttons which are “locked” or become unavailable when pressing the [PANEL LOCK] button on the panel. When the check mark is removed from the check box, the corresponding button is available even if Panel Lock is turned on.

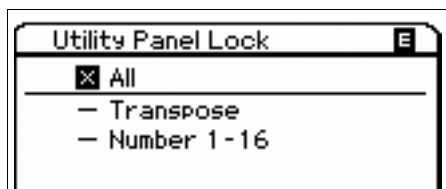

Quick Setup

Quick Set

This lets you call up the parameter settings about the external connection in the Performance mode/Multi mode simply by selecting the one from the Preset. It is convenient since the parameters in various displays are set to the appropriate values simply by selecting the Quick Set number. The initial settings and description of each Quick Setup number is as follows:

Quick Setup number	Description
1	When recording performance data other than Arpeggio data to a DAW software on a computer.
2	When recording performance data including Arpeggio data to a DAW software on a computer.
3	When using the S90 XS/S70 XS as a stand-alone device, without connecting to a DAW software or other MIDI devices.



Saving/Loading Data (File Mode)

In the File mode, you can save/load the data such as Voice and Performance created on this instrument. To enter the File mode, press the [FILE] button.

This section explains how to save/load all the data on the user memory of this instrument as an “All” file (extension: X2A).

Saving the settings to a USB storage device

1 Connect a USB storage device to the USB TO DEVICE terminal of this instrument.

2 Press the [FILE] button to enter the File mode.

The File Select display appears.



3 Select “Save” by using the cursor buttons then press the [ENTER] button.

The internal flash memory and USB storage device are shown on the File Save display.

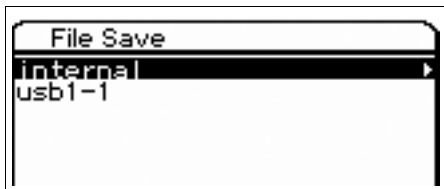

4 Select the USB storage device by using the Cursor [▲]/[▼] buttons then press the [ENTER] button.

The root directory of the USB storage device is shown.



5 Select the desired directory then press the [ENTER] button.

To save the file to the directory, move the cursor to “NEW FILE” then press the [ENTER] button. The display for selecting the file type is shown.

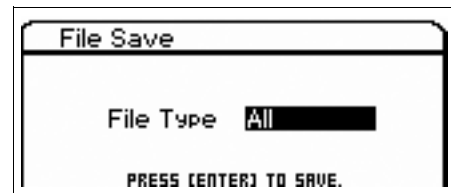

6 Select the File type then press the [ENTER] button.

Select “All” if you want to save all the data. When the data saved via “All” is loaded back to the instrument, you can still select specific data you wish to retrieve—such as specific Voices or specific Voice Banks—as well as all of the data.

7 Assign a name to the file then press the [ENTER] button.

Select the desired characters by using the data dial and cursor buttons then press the [INC] button to enter the selected character. To cancel the selected character, press the [DEC] button.



8 Press the [ENTER] button again after the confirmation display is shown.

This actually saves the file.



Loading the settings from a USB storage device

1 Connect a USB storage device to the USB TO DEVICE terminal of this instrument.

2 Press the [FILE] button to enter the File mode.

The File Select display appears.



3 Select "Load" by using the cursor buttons then press the [ENTER] button.

The internal flash memory and USB storage device are shown on the File Load display.

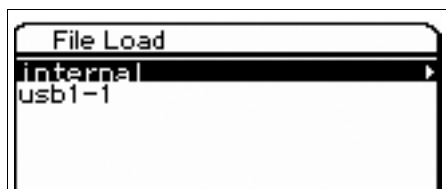

4 Select the USB storage device by using the Cursor [▲]/[▼] buttons then press the [ENTER] button.

The root directory of the USB storage device is shown.



If there is a folder or directory in the USB storage device, move the path by using the Cursor [▶] button.

5 Select "X2A" as the extension then press the [ENTER] button.

The loadable data types are shown and one of them can be selected.

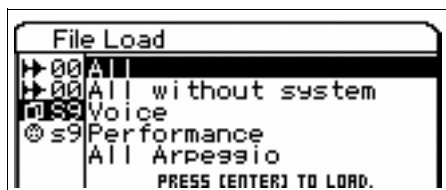

6 Select the desired data type then press the [ENTER] button.

To load all the Voices or Performances to all the internal User Banks, select "Voice" or "Performance" then press the [ENTER] button. To load a specific Voice Bank or Performance Bank, select "Voice" or "Performance," press the Cursor [▶] button, select the desired Bank, and then press the [ENTER] button.

7 Press the [ENTER] button again after the confirmation display is shown.

USB storage devices

Connection Examples

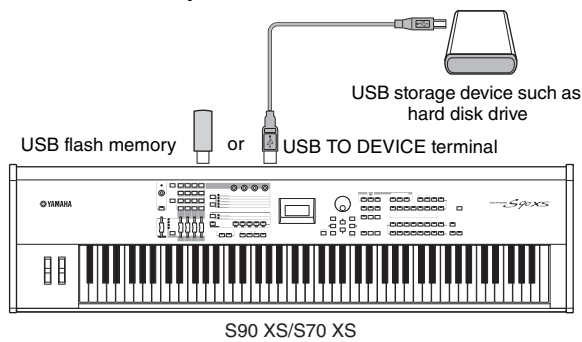

Compatible USB devices

Connect only a USB storage device (such as hard disk, CD-ROM, flash memory and other drives) to the USB TO DEVICE connector. Other USB devices such as a computer keyboard or mouse cannot be used. Both bus-powered (powered by the host device) or self-powered (battery or external power supply) types can be used. Before purchasing USB storage devices, please consult your Yamaha dealer, or an authorized Yamaha distributor (see list at end of the Owner's Manual) for advice, or see the following web page:

<http://www.yamahasynth.com/>

NOTE Although CD-R/RW drives can be used to load data to the instrument, they cannot be used for saving data. However, you can transfer the data to a computer and save it to a CD using the CD-R/RW drive on the computer.

Formatting USB storage media

When an unformatted USB storage device is connected to the USB TO DEVICE connector or when unformatted media is inserted to the USB device connected to the USB TO DEVICE connector, the indication "unformatted device (usb***)" is shown in the device list on the Save/Load display of the File mode. If this happens, execute the Format operation in the File Job display.

NOTE The three asterisks (***) in the example indication above denote the sequential serial numbers of the connected devices which need to be formatted. When several partitions are included in a single device, the partition number is indicated at the right of the serial number.

Precautions when using the USB TO DEVICE terminal

Please keep in mind the following points:



CAUTION

Never turn the USB device's power on/off and never plug/unplug the USB cable when the connected USB storage device is the self-powered type. Doing so may result in the operation of the synthesizer "freezing" or hanging up. While the instrument is accessing data (such as in the Save, Load and Delete operations in the File mode), do NOT unplug the USB cable, do NOT remove the media from the device, and do NOT turn the power off to either device. Doing so may corrupt the data on either or both devices.

Display Messages

LCD Indication	Description
All data is initialized upon power-on. Continue?	Confirms whether you want to turn on the "Power on auto factory set switch" parameter or not.
Are you sure?	Confirms whether you want to execute a specified operation or not.
Assign Vocoder Voice to Part 1. Continue?	Confirms whether you want to select a Vocoder Voice via the Category Search display when setting the Output Select of the A/D Input part to "Vocoder" when Part 1 is not a Vocoder Voice in the Performance/Multi mode.
Assign Vocoder Voice. Continue?	Confirms whether you want to select a Vocoder Voice via the Category Search display when setting the Output Select of the A/D Input part to "Vocoder" when the Voice is not a Vocoder Voice in the Voice mode.
Audio Rec stopped due to lack of memory space.	This message appears when memory space has run out and audio recording has been stopped.
Bad disk or memory.	The external storage device connected to this synthesizer is unusable. Format the external storage device and try again.
Bulk data protected.	Bulk Data cannot be received because of the setting in the Utility mode.
Can't execute.	The synthesizer cannot execute because of the settings or situations.
Click off.	The Click (metronome) has been turned off.
Click on.	The Click (metronome) has been turned on.
Completed.	The specified load, save, format, or other Job has been completed.
Connecting to USB device...	Recognizing the USB storage device connected to the USB TO DEVICE terminal.
Copied Arpeggio type.	Copied Arpeggio type.
Device number is off.	Bulk data cannot be transmitted/received since the device number is off.
Device number mismatch.	Bulk data cannot be transmitted/received since the device numbers don't match.
Directory is not empty.	You have attempted to delete a folder that contains data.
Disk or memory is full.	The external storage device is full and no more data can be saved. Use a new external storage device, or make space by erasing unwanted data from the storage device.
Disk or memory is write-protected.	The external storage device is write protected, or you have attempted to write to a read-only medium such as CD-ROM.
Disk or memory read/write error.	An error occurred while reading or writing to/from an external storage device.
Executing...	Executing the processing.
Executing... ****.wav	This message appears when creating a audio file via Audio Record function. "****" is the name of the file.
Executing... Please keep power on.	This message appears when processing with writing to the internal memory. Please keep power on while this message is shown.
File already exists.	A file having the same name as the one you are about to save already exists.
File is not found.	The specified file was not found on the external storage device during a load operation.
File path is too long.	The file or directory you tried to access cannot be accessed because the amount of characters indicating the path is too long.
Illegal bulk data.	An error occurred while receiving the Bulk data or Bulk Request message.
Illegal file name.	The specified file name is invalid. Try entering a different name.
Illegal file.	The file specified for loading is unusable by this synthesizer or cannot be loaded in the current mode.
Learning...	This message appears when learning a parameter to the Knob/Slider in the Remote mode.
Load All Arpeggios. Are you sure?	Confirms whether you want to load the "All Arpeggio" or not in the File mode.
Load All Performances. Are you sure?	Confirms whether you want to load the "All Performances" or not in the File mode.
Load All Voices. Are you sure?	Confirms whether you want to load the "All Voices" or not in the File mode.
Load All without system. Are you sure?	Confirms whether you want to load the "All without system" or not in the File mode.

LCD Indication	Description
Load All. Are you sure?	Confirms whether you want to load the "All" or not in the File mode.
Load Seq Chain file. Are you sure?	Confirms whether you want to load the "Seq Chain file" or not in the File mode.
MIDI buffer full.	Failed to process the MIDI data because too much data was received at one time.
MIDI checksum error.	An error occurred when receiving bulk data.
Mixing Voice full.	The Mixing Voice cannot be stored because the number of Voices already stored has exceeded the maximum capacity.
No read/write authority to the file.	No permission for reading/writing on the external storage device.
Now executing Factory set... Please keep power on.	Indicates this synthesizer is restoring the factory-programmed settings.
Now loading...	Indicates that a file is being loaded.
Now receiving MIDI bulk data...	Indicates this synthesizer is receiving MIDI bulk data.
Now saving...	Indicates that a file is being saved.
Now scanning autoload file...	Scanning for the files specified for Auto Load.
Now transmitting MIDI bulk data...	Indicates this synthesizer is transmitting MIDI bulk data.
Overwrite. Are you sure?	A save operation will overwrite data on the external storage device as destination, and this message confirms whether it is OK to continue or not. Press [ENTER] (Yes) or [EXIT] (No) as required.
Part x is used for Drum Assign.	This message appears when the Part switches of all Parts are set to on, and the Drum Assign function used Part "x" for the Drum Part in Performance mode.
Part x is used for Layer.	This message appears when the Part switches of all Parts are set to on, and the Layer function used Part "x" for the Layer Part in the Performance mode.
Part x is used for Split.	This message appears when the Part switches of all Parts are set to on, and the Split function used Part "x" for the Split Part in the Performance mode.
Please stop Audio Play/Rec.	The operation you have attempted to execute cannot be done during Audio Rec/Play recording or playback.
Please stop sequencer.	The operation you have attempted to execute cannot be done during SEQ PLAY playback.
Save Audio Rec file?	Confirming whether you want to save the recorded file or not in Audio Rec/Play mode.
Seq Chain stored.	This message appears when the Seq Chain settings has been stored.
Sequence memory full.	The internal memory for Sequence data is full, preventing any further operation (such as recording, editing, Job execution, MIDI reception/transmission, or loading from the external storage device). Try again after erasing unwanted Song, Pattern, or User Phrase data.
Set Part 1 Ins Sw to on to use Vocoder.	Set the Insertion Switch of Part 1 to on to use the Vocoder when setting the Output Select of the A/D Input part to "Vocoder."
MIDI data overload.	The amount of MIDI data is too large to play.
Store Voice?	Confirms you want to store the editing Voice when executing the Performance Creator (Layer/Split/Drum Assign) feature to the editing Voice in the Voice mode.
The received MIDI bulk data's type is not compatible with the current mode/voice type.	This message appears when MIDI bulk data is received in a different mode other than the currently selected mode. The bulk data is received in the same mode as the transmitting mode. This message also appears when the Voice type (Normal Voice/Drum Voice) of the destination Mixing Parts is different from the bulk-dump-transferred Voice type. The destination Parts assigned to the same Voice type as the bulk-dump-transferred Voice type are selected.
This Performance uses User Voices.	The loaded Performance uses User Voices. Confirm whether the same Voices as at the time of saving are stored at the same User Bank/Number or not.
USB connection terminated. Press any button.	A break in the connection with the USB storage device has occurred because of an abnormal electric current. Disconnect the USB storage device from the USB TO DEVICE connector, then press any of the panel buttons.
Utility stored.	The settings in the Utility mode have been stored.

Troubleshooting

The following table provides troubleshooting hints and page references for some common problems. You may solve your problem by executing the Factory Set (page 18) after backing up your data to an external storage device. If the problem persists, then contact your Yamaha dealer or service center (page 63).

No Sound

■ Is the S90 XS/S70 XS properly connected to related external equipment (e.g., amplifier, speaker, headphone) via audio cables?

Since the S90 XS/S70 XS has no built-in speakers, You will need an external audio system or a set of stereo headphones to properly monitor it.

■ Is the power of this synthesizer and any external equipment connected to this synthesizer turned on?

■ Have you made all the appropriate level settings—including the Master Volume on this synthesizer and the volume settings on any connected external equipment?

Is the Foot Controller pressed down (when it is connected to the FOOT CONTROLLER jack)?

■ Are all four Sliders set to appropriate levels (other than zero or minimum)?

■ Is the Local Control set to OFF?

If this is set to off, the internal tone generator will not sound.

[UTILITY] → MIDI → Local Control

■ Are the MIDI volume or MIDI expression settings too low when using the external controller?

■ Are the effect and filter settings appropriate?

If you are using the filter, try changing the cutoff frequency. Some cutoff settings may filter out all of the sound.

[VOICE] → [EDIT] → Effect

[VOICE] → [EDIT] → Filter/EG

[PERFORM] → [EDIT] → Common → Effect

[PERFORM] → [EDIT] → Common → Filter/EG

[PERFORM] → [EDIT] → Part selection → Filter/EG

[MULTI/SEQ PLAY] (selecting Multi mode) → [EDIT] → Common → Effect

[MULTI/SEQ PLAY] (selecting Multi mode) → [EDIT] → Part selection → Filter/EG

■ Is “Vocoder” selected as the Insertion Effect Type of the Voice?

If so, set the parameters related to the AD Input Part and MIC INPUT connector to the appropriate values then play the keyboard while inputting your voice into the microphone connected to the S90 XS/S70 XS. Check whether or not the INPUT GAIN knob on the panel is set to the minimum position.

[VOICE] → [EDIT] → Effect → Ins Connect Type: vocoder

[UTILITY] → [VOICE] → A/D Out → Output Select: vocoder

■ Are the volume or expression settings too low?

[UTILITY] → General → Volume

[VOICE] → [EDIT] → Play Mode → Volume

[VOICE] → [EDIT] → Easy Element Edit mode via the Slider Function button → Sliders

[PERFORM] → [EDIT] → Common → Play Mode → Volume

[PERFORM] → [EDIT] → Part selection → Play Mode → Volume

[MULTI/SEQ PLAY] (selecting Multi mode) → [EDIT] → Part selection → Play Mode → Volume

■ **Are the parameter settings such as Element Switch, Part Switch, Note Limit and Velocity Limit appropriate?**

[VOICE] → [EDIT] → [MUTE] (lighting) → Number [9] – [16] buttons

[PERFORM] → [PART ON/OFF]

[PERFORM] → [EDIT] → Part selection → Play Mode → Note Limit Lo/Hi

[PERFORM] → [EDIT] → Part selection → Play Mode → Velocity Limit Lo/Hi

■ **When the Performance/Multi produces no sound, has a Voice been assigned to each Part?**

[PERFORM] → [EDIT] → Part selection → Voice

[MULTI/SEQ PLAY] (selecting Multi mode) → [EDIT] → Part selection → Voice

■ **When the Performance/Multi produces no sound, is the output setting of each Part set appropriately?**

[PERFORM] → [EDIT] → Part selection → Play Mode → Output Select

[MULTI/SEQ PLAY] (selecting Multi mode) → [EDIT] → Part selection → Play Mode → Output Select

■ **When the Multi produces no sound, are the output port/channel of each track in the external sequencer and the receive channel of each Part in the Multi set appropriately?**

[MULTI/SEQ PLAY] (selecting Multi mode) → [EDIT] → Part selection → Voice → Receive Ch

■ **When the Performance/Multi produces no sound, is the “Arpeggio Play Only” parameter of each Part turned on?**

[PERFORM] → [EDIT] → Part selection → Voice → Arp Play Only

[MULTI/SEQ PLAY] (selecting Multi mode) → [EDIT] → Part selection → Voice → Arp Play Only

No sound from the MIC INPUT jack

■ **Is the microphone switch turned on?**

■ **Is the cable between the microphone and the synthesizer properly connected?**

■ **Is the [MIC ON/OFF] button set to on (lamp is lit)?**

■ **Is the INPUT GAIN knob turned fully counter-clockwise (to the minimum)?**

■ **Are the volume settings of the A/D Input Part too low?**

Selecting “MIC” via the Knob Function button → VOLUME knob

■ **Are the effect settings appropriate?**

[UTILITY] → Voice → A/D FX

[PERFORM] → [EDIT] → Common → A/D FX

[MULTI/SEQ PLAY] (selecting Multi mode) → [EDIT] → Common → A/D FX

■ **Is the output setting of the A/D Input Part set appropriately?**

[UTILITY] → Voice → A/D Out → Output Select

[PERFORM] → [EDIT] → Common → A/D Out → Output Select

[MULTI/SEQ PLAY] (selecting Multi mode) → [EDIT] → Common → A/D Out → Output Select

Split does not work via the external MIDI device

■ **The settings of the “Split Sw” parameter and “Split Lower/Upper” parameter in the Performance mode work only when playing the keyboard of the instrument itself.**

Playback continues without stopping

- When the [ARP ON/OFF] button is turned on, press it so that its lamp is turned off.
- In Sequence Play Mode, press the [START/STOP] button.
- When the click (metronome) sound continues, hold down the [SHIFT] button and press the [START/STOP] button to stop the sound.

The sound is distorted

■ Are the effect settings appropriate?

Use of an effect at certain settings may produce distortion.

[VOICE] → [EDIT] → Effect

[PERFORM] → [EDIT] → Common → Effect

[MULTI/SEQ PLAY] (selecting Multi mode) → [EDIT] → Common → Effect

Use of the Master Effect at certain settings may produce distortion.

[UTILITY] → Voice → Master FX

[PERFORM] → [EDIT] → Common → Effect → Master

[MULTI/SEQ PLAY] (selecting Multi mode) → [EDIT] → Common → Effect → Master

■ Are the filter settings appropriate?

Excessively high filter resonance settings can cause distortion.

[VOICE] → [EDIT] → Filter/EG

[PERFORM] → [EDIT] → Common → Filter/EG

[PERFORM] → [EDIT] → Part selection → Filter/EG

[MULTI/SEQ PLAY] (selecting Multi mode) → [EDIT] → Part selection → Filter/EG

■ Are any of the following volume parameters set so high that clipping is occurring?

[UTILITY] → General → Volume

[UTILITY] → General → L&R Gain

[VOICE] → [EDIT] → Play Mode → Volume

[PERFORM] → [EDIT] → Common → Play Mode → Volume

[PERFORM] → [EDIT] → Part selection → Play Mode → Volume

[MULTI/SEQ PLAY] (selecting Multi mode) → [EDIT] → Part selection → Play Mode → Volume

Sound is cut off

- Is the entire sound (via your keyboard playback and Sequence playback) exceeding the maximum polyphony of the synthesizer?

Only one note sounds at a time

■ When this situation occurs, the Mono/Poly parameter in the current mode is set to “mono.”

If you wish to play chords, set this parameter to “poly.”

[VOICE] → [EDIT] → Play Mode → Mono/Poly

[PERFORM] → [EDIT] → Part selection → Play Mode → Mono/Poly

[MULTI/SEQ PLAY] (selecting Multi mode) → [EDIT] → Part selection → Play Mode → Mono/Poly

Wrong pitch or unexpected pitch

- Is the Tune parameter in the Utility mode set to a value other than “0”?

[UTILITY] → General → Tune

- Is the Note Shift parameter in the Utility mode set to a value other than “0”?

[UTILITY] → General → Note Shift

- When the Voice produces a wrong pitch, is the appropriate tuning system selected from Micro Tune parameter in the Voice Edit mode?

[UTILITY] → Micro Tune

- When the Performance/Multi produces a wrong pitch, is the Note Shift parameter of each Part set to a value other than “0”?

[PERFORM] → [EDIT] → Part selection → Play Mode

[MULTI/SEQ PLAY] (selecting Multi mode) → [EDIT] → Part selection → Play Mode

No effect is applied

- Have the REVERB and CHORUS Knobs/Sliders been turned fully to the minimum?
- Have any or all of the effect types been set to “thru” or “off”?
- Is the EFFECT ON/OFF parameter of each Effect set to OFF?
- When this occurs in the Performance/Multi mode, check whether the Insertion Switch (Ins Effect Sw) parameters are set properly or not.

[PERFORM] → [EDIT] → Part selection → FX Send → Ins Effect Sw

[MULTI/SEQ PLAY] (selecting Multi mode) → [EDIT] → Part selection → FX Send → Ins Effect Sw

Vocoder does not work when selecting a Vocoder Voice

- Is the output of the A/D Input Part set to “vocoder”?

[UTILITY] → Voice → A/D Out → Output Select

[PERFORM] → [EDIT] → Common → A/D Out → Output Select

[MULTI/SEQ PLAY] (selecting Multi mode) → [EDIT] → Common → A/D Out → Output Select

The Edit Indicator appears, even when parameters are not being edited

- Keep in mind that even though the Edit mode is not active, simply moving a Knob/Slider changes the current Voice, Performance, or Multi, causing the Edit Indicator to appear.
- Some Arpeggio types include MIDI Control Change messages. When you play back such an Arpeggio type, the sound of the current Voice may inadvertently be changed and the Edit Indicator may appear in the top right of the display.

Cannot start the Arpeggio

- Check whether the [ARP ON/OFF] button is turned on or off.
- Is the MIDI Sync parameter set to auto or internal (using internal clock)?

[UTILITY] → MIDI → MIDI sync

- Have you selected a User Arpeggio type (with no User Data)?

To use the User Arpeggios, the User Arpeggio data created in the MOTIF XS must be loaded to the S90 XS/S70 XS.

- Are the Arpeggio related parameters such as Note Limit and Velocity Limit set appropriately?

[VOICE] → [EDIT] → Arpeggio → Arp Edit → Note Limit Lo/Hi

[VOICE] → [EDIT] → Arpeggio → Arp Edit → Velocity Limit Lo/Hi

[PERFORM] → [EDIT] → Part selection → Arpeggio → Arp Edit → Note Limit Lo/Hi

[PERFORM] → [EDIT] → Part selection → Arpeggio → Arp Edit → Velocity Limit Lo/Hi

[MULTI/SEQ PLAY] (selecting Multi mode) → [EDIT] → Part selection → Arpeggio → Arp Edit → Note Limit Lo/Hi

[MULTI/SEQ PLAY] (selecting Multi mode) → [EDIT] → Part selection → Arpeggio → Arp Edit → Velocity Limit Lo/Hi

- When this situation occurs in the Performance/Multi mode, check the Arpeggio Switch parameter.

[PERFORM] → [EDIT] → Part selection → Arpeggio → Arp Edit → Arp Sw

[MULTI/SEQ PLAY] (selecting Multi mode) → [EDIT] → Part selection → Arpeggio → Arp Edit → Arp Sw

Cannot stop the Arpeggio

- When Arpeggio playback does not stop even when you release the key, set the Arpeggio Hold parameter to “off” via the [ARP HOLD] 1 – 4 buttons.

The Voice assigned to the Performance produces a different sound from the one in the Voice mode

- This is normal because the Voice sound is determined by the parameter settings in the Performance mode. For the Performance Parts, you will need to apply basically the same parameter settings as those used in the Voice mode. Regarding the Effect settings except for the send level, you can copy the settings in the Voice mode to the Performance part in the following display. By executing this Job, you can ensure that the Voice will sound the same in the Performance mode as it does in the Voice mode.

[PERFORM] → [JOB] → Copy → Voice

[PERFORM] → [EDIT] → Part selection → FX Send

Data communication between the computer and the S90 XS/S70 XS does not work properly

- Check whether the Port setting on the computer is appropriate or not.
- Check whether the MIDI In/Out settings of the instrument are appropriate or not.

[UTILITY] → [MIDI] → MIDI In/Out

The S90 XS/S70 XS does not sound properly even when playing back the song data on the computer or the MIDI instrument connected to the S90 XS/S70 XS

- Is the S90 XS/S70 XS set to the Multi mode?

Select the Multi mode to play multiple channels simultaneously.

MIDI bulk data transmission/reception does not work properly

- **Is the Receive Bulk parameter set to off?**

Set the Receive Bulk parameter to on.

[UTILITY] → [MIDI] → Receive Bulk

- **If the data was saved with the Bulk Dump function of the S90 XS/S70 XS, you need to set the Device Number to the same number before Bulk Dump transmission.**

[UTILITY] → [MIDI] → Device No.

- **When transmission does not work properly, is the device number of the MIDI instrument connected to the S90 XS/S70 XS set to match the Device Number Parameter in the Utility mode?**

[UTILITY] → [MIDI] → Device No.

Cannot save data to the external USB storage device

- **Is the USB storage device being used write protected? (Write-protect should be set to off for saving data.)**

- **Is the USB storage device being used properly formatted?**

[FILE] → Save → Selecting USB storage device → [JOB] → FORMAT

Cannot play an audio file

- **Is the format of the audio file correct?**

The S90 XS/S70 XS can play only stereo WAVE (.wav)/AIFF (.aif) files at 44.1kHz/16-bit.

Cannot enter the Edit mode

- **Is the S90 XS/S70 XS in the File mode?**

After exiting from the File mode, press the [EDIT] button.

Specifications

	S90 XS	S70 XS	
Keyboard	88 keys, Balanced Hammer Effect Keyboard (Initial Touch/Aftertouch)	76 keys, Balanced Hammer Effect Keyboard (Initial Touch/Aftertouch)	
Tone Generator block	Tone Generator	AWM2 with Expanded Articulation	
	Maximum polyphony	128 notes	
	Multi-Timbral Capacity	16 Internal Parts + Mic Input Part	
	Wave	456 MB (when converted to 16-bit linear format), 2,772 waveforms	
	Voice	Preset: 1,024 normal voices + 64 drum kits GM: 128 normal voices + 1 drum kits User: 128 x 4 (Bank 1 – 3: selected and copied from Preset bank) Normal Voice + 32 drum kits	
	Performance	User: 128 x 4 (up to 4 Parts)	
	Multi	User: 128	
	Filter	18 types	
	Effects	Reverb x 9 types, Chorus x 22 types, Insertion (A, B) x 53 types x 8 blocks, Vocoder x 1 (uses both Insertion Effect A and B blocks), Master Effect x 9 types, Master Equalizer (5 bands), Part EQ (3 bands, stereo)	
Sequencer Section	Sequence Play	SMF Format 0/1 (playback only)	
	BPM (Tempo)	5 – 300	
	Number of Chain Steps	100	
	Arpeggio	Preset x 6,779 types User x 256 types (when loading the User Arpeggio data of MOTIF XS).	
Audio Rec/Play Section	Format	Recording: WAVE (.wav/44.1kHz/16-bit/stereo) Playback: WAVE (.wav/44.1kHz/16-bit/stereo), AIFF (.aif/44.1kHz/16-bit/stereo)	
	Master	User: 128 * 4 Zones (Master keyboard settings), Assignable Knob/Slider settings, Program Change Table	
Other	Sequence Software compatible with the Remote Control function	For Windows®: Cubase 5, Cubase 4.5, SONAR 8 For Macintosh®: Cubase 5, Cubase 4.5, Logic Pro 8, Digital Performer 6 * Functions to be controlled by the S90 XS/S70 XS differ depending on the software you use.	
	Controllers	Pitch Bend wheel, Modulation wheel, Sliders (4), Knobs (4), Assignable Function button (2), Data dial, Input Gain	
	Display	160 x 64 dot graphic backlit LCD	
	Jack and Terminals	OUTPUT L/MONO, R (standard phone jack), ASSIGNABLE OUTPUT L, R (standard phone jack), MIC INPUT (combo jack), PHONES (standard stereo phone jack), FOOT CONTROLLER 1, 2, FOOT SWITCH x 2 (SUSTAIN, ASSIGNABLE), MIDI IN/OUT/THRU, USB (TO HOST, TO DEVICE), AC IN	
	Power Consumption	25 W	
	Dimensions, Weight	1,472 (W) x 385 (D) x 173 (H) mm 22.4 kg	1,320 (W) x 385 (D) x 173 (H) mm 20.4 kg
	Accessories	AC Power cord, Owner's Manual (this book), Owner's Manual CD-ROM (containing Reference Manual and Data List), DVD-ROM (containing DAW software)	

* Specifications and descriptions in this owner's manual are for information purposes only. Yamaha Corp. reserves the right to change or modify products or specifications at any time without prior notice. Since specifications, equipment or options may not be the same in every locale, please check with your Yamaha dealer.

Note on source code distribution

For three years after the final factory shipment, you may request from Yamaha the source code for any portions of the product which are licensed under the GNU General Public License by writing to the following address:

MP business unit PA-DMI Division, YAMAHA Corporation
10-1 Nakazawa-cho, Naka-ku, Hamamatsu, 430-8650, JAPAN

The source code will be provided at no charge; however, we may require you to reimburse Yamaha for the cost of delivering the source code to you.

- Note that we shall bear no responsibility whatsoever for any damage arising from changes (additions/ deletions) made to the software for this product by a third party other than Yamaha (or party authorized by Yamaha).
- Note that re-use of source code released to the public domain by Yamaha is unguaranteed, and Yamaha shall not bear any responsibility whatsoever for the source code.
- The source code can be downloaded from the following address:
http://www.yamahasyth.com/download/source/s_xs
- About GNU General Public License, refer to the separate Data List (PDF documentation).

Index

A

Arp 1 – 5	26
Arp 1 – 5 Type	26
[ARP ON/OFF]	26
ARP SELECT	27
Arp Select	26
Arpeggio	26
Arpeggio Type	26
Arpeggio/Effect Function button	27
Audio data (Recording)	34
[AUDIO REC/PLAY]	34
Audio Record/Play mode	34

B

Brightness	17
Bulk Dump	57

C

[CATEGORY SEARCH]	22
Category Search	22
Click (Metronome)	45
[COMMON]	32
Control Template	40
Cubase	39

D

Data List	8
[DAW REMOTE]	39
Demo Song	17
Digital Performer	39
[DRUM ASSIGN]	30
Drum Assign	30
Drum Voice	21

E

Edit Indicator	24
Effects	24
Element	24
Element Edit	24
Element level	24

F

Factory Set	18
[FAVORITE]	23
Favorite Category	22
[FILE]	47
File mode	47
Format (Audio file)	57
Format (File mode)	49

G

GM Voice	21
----------------	----

H

Headphones	16
------------------	----

I

INPUT GAIN knob	33
-----------------------	----

K

Key Edit	24
Knob	23
Knob Function buttons	23, 33

L

[LAYER]	28
Layer	28
LCD CONTRAST	17
LCD Mode	45
Load	48
Logic Pro	39

M

[MASTER]	43
Master Effect (Voice mode)	45
Master EQ (Voice mode)	45
Master Keyboard	43
Master mode	43
Memory	43
Metronome (Click)	45
MIC (Knob Function)	33
MIC INPUT jack	33
[MIC ON/OFF]	33
Micro Tuning	45
Microphone	33
MIDI channel	37
MIDI port	37
[MIXING]	38
Mode	19
Multi mode	38
[MULTI/SEQ PLAY] (Multi mode)	38
[MULTI/SEQ PLAY] (Sequence Play mode)	41
Multi-timbral tone generator	38

N

Name	31
Naming	47
Normal Voice	21
Number [1] – [16]	14

O

Owner's Manual CD-ROM 8

P

[PANEL LOCK] 46
 Panel Lock 46
 [PART SELECT] 32
 PDF documentation 8
 Performance 32
 Performance Creator 28
 Performance mode 32
 Playing back 35
 Power on Mode 45
 Power Supply 16
 Preset Bank 21

Q

Quick Setup 46

R

Rec Storage 34
 Recording 34
 Reference Manual 8
 Remote mode 38

S

S90 XS/S70 XS Editor 40
 S90 XS/S70 XS Extension 38
 S90 XS/S70 XS Remote Editor 38
 S90 XS/S70 XS Remote Tools 38
 Save 47
 [SHIFT] 12
 Simple Display 23
 SONAR 39
 Speaker 16
 [SPLIT] 29
 Split 29
 Studio Manager V2 40

T

Trigger Level 34

U

USB Storage Device 49
 USB TO HOST terminal 36
 USB-MIDI Driver 36
 User Bank 21
 Utility mode 45

V

[VOICE] 21
 Voice mode 21
 Volume 17
 VST3 plug-in 40

W

Write-protect 57

Z

Zone 43
 Zone Switch 44

ATTENTION

SOFTWARE LICENSE AGREEMENT

PLEASE READ THIS SOFTWARE LICENSE AGREEMENT ("AGREEMENT") CAREFULLY BEFORE USING THIS SOFTWARE. YOU ARE ONLY PERMITTED TO USE THIS SOFTWARE PURSUANT TO THE TERMS AND CONDITIONS OF THIS AGREEMENT. THIS AGREEMENT IS BETWEEN YOU (AS AN INDIVIDUAL OR LEGAL ENTITY) AND YAMAHA CORPORATION ("YAMAHA").

BY BREAKING THE SEAL OF THIS PACKAGE YOU ARE AGREEING TO BE BOUND BY THE TERMS OF THIS LICENSE. IF YOU DO NOT AGREE WITH THE TERMS, DO NOT INSTALL, COPY, OR OTHERWISE USE THIS SOFTWARE.

THIS AGREEMENT PROVIDES YOUR USE-CONDITIONS ABOUT THE "DAW" SOFTWARE OF STEINBERG MEDIA TECHNOLOGIES GMBH ("STEINBERG") WHICH IS BUNDLED WITH THIS PRODUCT. SINCE THE END-USER SOFTWARE LICENSE AGREEMENT (EUSLA) SHOWN ON YOUR PC-DISPLAY IN YOUR INSTALLING THE "DAW" SOFTWARE IS REPLACED BY THIS AGREEMENT, YOU SHOULD DISREGARD THE EUSLA. THAT IS, IN THE INSTALLING PROCESS, YOU SHOULD SELECT "AGREE" WITH THE EUSLA, WITHOUT YOUR JUDGMENT THERETO, SO AS TO PROCEED TO THE NEXT PAGE.

1. GRANT OF LICENSE AND COPYRIGHT

Yamaha hereby grants you the right to use one copy of the software program(s) and data ("SOFTWARE") accompanying this Agreement. The term SOFTWARE shall encompass any updates to the accompanying software and data. The SOFTWARE is owned by STEINBERG, and is protected by relevant copyright laws and all applicable treaty provisions. Yamaha has acquired the sublicense right to license you to use the SOFTWARE. While you are entitled to claim ownership of the data created with the use of SOFTWARE, the SOFTWARE will continue to be protected under relevant copyrights.

You may use the SOFTWARE on a **single computer**.

You may make one copy of the SOFTWARE in machine-readable form for backup purposes only, if the SOFTWARE is on media where such backup copy is permitted. On the backup copy, you must reproduce Yamaha's copyright notice and any other proprietary legends that were on the original copy of the SOFTWARE.

You may permanently transfer to a third party all your rights in the SOFTWARE only when you transfer this product together, provided that you do not retain any copies and the recipient reads and agrees to the terms of this Agreement.

2. RESTRICTIONS

You may not engage in reverse engineering, disassembly, decompilation or otherwise deriving a source code form of the SOFTWARE by any method whatsoever.

You may not reproduce, modify, change, rent, lease, or distribute the SOFTWARE in whole or in part, or create derivative works of the SOFTWARE.

You may not electronically transmit the SOFTWARE from one computer to another or share the SOFTWARE in a network with other computers.

You may not use the SOFTWARE to distribute illegal data or data that violates public policy.

You may not initiate services based on the use of the SOFTWARE without permission by Yamaha Corporation.

Copyrighted data, including but not limited to MIDI data for songs, obtained by means of the SOFTWARE, are subject to the following restrictions which you must observe.

Data received by means of the SOFTWARE may not be used for any commercial purposes without permission of the copyright owner.

Data received by means of the SOFTWARE may not be duplicated, transferred, or distributed, or played back or performed for listeners in public without permission of the copyright owner.

The encryption of data received by means of the SOFTWARE may not be removed nor may the electronic watermark be modified without permission of the copyright owner.

3. TERMINATION

This Agreement becomes effective on the day that you receive the SOFTWARE and remains effective until terminated. If any copyright law or provisions of this Agreement is violated, the Agreement shall terminate automatically and immediately without notice from Yamaha. Upon such termination, you must immediately destroy the licensed SOFTWARE, any accompanying written documents and all copies thereof.

4. LIMITED WARRANTY ON MEDIA

As to SOFTWARE sold on tangible media, Yamaha warrants that the tangible media on which the SOFTWARE is recorded will be free from

defects in materials and workmanship under normal use for a period of fourteen (14) days from the date of receipt, as evidenced by a copy of the receipt. Yamaha's entire liability and your exclusive remedy will be replacement of the defective media if it is returned to Yamaha or an authorized Yamaha dealer within fourteen days with a copy of the receipt. Yamaha is not responsible for replacing media damaged by accident, abuse or misapplication. TO THE FULLEST EXTENT PERMITTED BY LAW, YAMAHA EXPRESSLY DISCLAIMS ANY IMPLIED WARRANTIES ON THE TANGIBLE MEDIA, INCLUDING THE IMPLIED WARRANTIES OF MERCHANTABILITY AND FITNESS FOR A PARTICULAR PURPOSE.

5. DISCLAIMER OF WARRANTY ON SOFTWARE

You expressly acknowledge and agree that use of the SOFTWARE is at your sole risk. The SOFTWARE and related documentation are provided "AS IS" and without warranty of any kind.

NOTWITHSTANDING ANY OTHER PROVISION OF THIS AGREEMENT, YAMAHA EXPRESSLY DISCLAIMS ALL WARRANTIES AS TO THE SOFTWARE, EXPRESS, AND IMPLIED, INCLUDING BUT NOT LIMITED TO THE IMPLIED WARRANTIES OF MERCHANTABILITY, FITNESS FOR A PARTICULAR PURPOSE AND NON-INFRINGEMENT OF THIRD PARTY RIGHTS. SPECIFICALLY, BUT WITHOUT LIMITING THE FOREGOING, YAMAHA DOES NOT WARRANT THAT THE SOFTWARE WILL MEET YOUR REQUIREMENTS, THAT THE OPERATION OF THE SOFTWARE WILL BE UNINTERRUPTED OR ERROR-FREE, OR THAT DEFECTS IN THE SOFTWARE WILL BE CORRECTED.

6. LIMITATION OF LIABILITY

YAMAHA'S ENTIRE OBLIGATION HEREUNDER SHALL BE TO PERMIT USE OF THE SOFTWARE UNDER THE TERMS HEREOF. IN NO EVENT SHALL YAMAHA BE LIABLE TO YOU OR ANY OTHER PERSON FOR ANY DAMAGES, INCLUDING, WITHOUT LIMITATION, ANY DIRECT, INDIRECT, INCIDENTAL OR CONSEQUENTIAL DAMAGES, EXPENSES, LOST PROFITS, LOST DATA OR OTHER DAMAGES ARISING OUT OF THE USE, MISUSE OR INABILITY TO USE THE SOFTWARE, EVEN IF YAMAHA OR AN AUTHORIZED DEALER HAS BEEN ADVISED OF THE POSSIBILITY OF SUCH DAMAGES. In no event shall Yamaha's total liability to you for all damages, losses and causes of action (whether in contract, tort or otherwise) exceed the amount paid for the SOFTWARE.

7. GENERAL

This Agreement shall be interpreted according to and governed by Japanese law without reference to principles of conflict of laws. Any dispute or procedure shall be heard before the Tokyo District Court in Japan. If for any reason a court of competent jurisdiction finds any portion of this Agreement to be unenforceable, the remainder of this Agreement shall continue in full force and effect.

8. COMPLETE AGREEMENT

This Agreement constitutes the entire agreement between the parties with respect to use of the SOFTWARE and any accompanying written materials and supersedes all prior or contemporaneous understandings or agreements, written or oral, regarding the subject matter of this Agreement. No amendment or revision of this Agreement will be binding unless in writing and signed by a fully authorized representative of Yamaha.

FCC INFORMATION (U.S.A.)

1. IMPORTANT NOTICE: DO NOT MODIFY THIS UNIT!

This product, when installed as indicated in the instructions contained in this manual, meets FCC requirements. Modifications not expressly approved by Yamaha may void your authority, granted by the FCC, to use the product.

2. IMPORTANT: When connecting this product to accessories and/or another product use only high quality shielded cables. Cable/s supplied with this product **MUST** be used. Follow all installation instructions. Failure to follow instructions could void your FCC authorization to use this product in the USA.

3. NOTE: This product has been tested and found to comply with the requirements listed in FCC Regulations, Part 15 for Class "B" digital devices. Compliance with these requirements provides a reasonable level of assurance that your use of this product in a residential environment will not result in harmful interference with other electronic devices. This equipment generates/uses radio frequencies and, if not installed and used according to the instructions found in the users manual, may cause interference harmful to the opera-

tion of other electronic devices. Compliance with FCC regulations does not guarantee that interference will not occur in all installations. If this product is found to be the source of interference, which can be determined by turning the unit "OFF" and "ON", please try to eliminate the problem by using one of the following measures:

Relocate either this product or the device that is being affected by the interference.

Utilize power outlets that are on different branch (circuit breaker or fuse) circuits or install AC line filter/s.

In the case of radio or TV interference, relocate/reorient the antenna. If the antenna lead-in is 300 ohm ribbon lead, change the lead-in to co-axial type cable.

If these corrective measures do not produce satisfactory results, please contact the local retailer authorized to distribute this type of product. If you can not locate the appropriate retailer, please contact Yamaha Corporation of America, Electronic Service Division, 6600 Orangethorpe Ave, Buena Park, CA90620

The above statements apply **ONLY** to those products distributed by Yamaha Corporation of America or its subsidiaries.

* This applies only to products distributed by YAMAHA CORPORATION OF AMERICA.

(class B)

COMPLIANCE INFORMATION STATEMENT (DECLARATION OF CONFORMITY PROCEDURE)

Responsible Party : Yamaha Corporation of America
Address : 6600 Orangethorpe Ave., Buena Park,
Calif. 90620
Telephone : 714-522-9011
Type of Equipment : Music Synthesizer
Model Name : S90 XS, S70 XS

This device complies with Part 15 of the FCC Rules.

Operation is subject to the following two conditions:

- 1) this device may not cause harmful interference, and
- 2) this device must accept any interference received including interference that may cause undesired operation.

See user manual instructions if interference to radio reception is suspected.

* This applies only to products distributed by
YAMAHA CORPORATION OF AMERICA.

(FCC DoC)

IMPORTANT NOTICE FOR THE UNITED KINGDOM

Connecting the Plug and Cord

WARNING: THIS APPARATUS MUST BE EARTHED IMPORTANT. The wires in this mains lead are coloured in accordance with the following code:

GREEN-AND-YELLOW	: EARTH
BLUE	: NEUTRAL
BROWN	: LIVE

As the colours of the wires in the mains lead of this apparatus may not correspond with the coloured markings identifying the terminals in your plug proceed as follows:

The wire which is coloured GREEN-and-YELLOW must be connected to the terminal in the plug which is marked by the letter E or by the safety earth symbol  or colored GREEN or GREEN-and-YELLOW.

The wire which is coloured BLUE must be connected to the terminal which is marked with the letter N or coloured BLACK.

The wire which is coloured BROWN must be connected to the terminal which is marked with the letter L or coloured RED.

• This applies only to products distributed by Yamaha Music U.K. Ltd. (3 wires)

For details of products, please contact your nearest Yamaha representative or the authorized distributor listed below.

Pour plus de détails sur les produits, veuillez-vous adresser à Yamaha ou au distributeur le plus proche de vous figurant dans la liste suivante.

Die Einzelheiten zu Produkten sind bei Ihrer unten aufgeführten Niederlassung und bei Yamaha Vertragshändlern in den jeweiligen Bestimmungsländern erhältlich.

Para detalles sobre productos, contacte su tienda Yamaha más cercana o el distribuidor autorizado que se lista debajo.

NORTH AMERICA

CANADA

Yamaha Canada Music Ltd.
135 Milner Avenue, Scarborough, Ontario,
M1S 3R1, Canada
Tel: 416-298-1311

U.S.A.

Yamaha Corporation of America
6600 Orangethorpe Ave., Buena Park, Calif. 90620,
U.S.A.
Tel: 714-522-9011

CENTRAL & SOUTH AMERICA

MEXICO

Yamaha de México S.A. de C.V.
Calz. Javier Rojo Gómez #1149,
Col. Guadalupe del Moral
C.P. 09300, México, D.F., México
Tel: 55-5804-0600

BRAZIL

Yamaha Musical do Brasil Ltda.
Rua Joaquim Floriano, 913 - 4º andar, Itaim Bibi,
CEP 04534-013 Sao Paulo, SP. BRAZIL
Tel: 011-3704-1377

ARGENTINA

Yamaha Music Latin America, S.A.
Sucursal de Argentina
Olga Cossetтини 1553, Piso 4 Norte
Madero Este-C1107CEK
Buenos Aires, Argentina
Tel: 011-4119-7000

PANAMA AND OTHER LATIN AMERICAN COUNTRIES/ CARIBBEAN COUNTRIES

Yamaha Music Latin America, S.A.
Torre Banco General, Piso 7, Urbanización Marbella,
Calle 47 y Aquilino de la Guardia,
Ciudad de Panamá, Panamá
Tel: +507-269-5311

EUROPE

THE UNITED KINGDOM/IRELAND

Yamaha Music U.K. Ltd.
Sherbourne Drive, Tilbrook, Milton Keynes,
MK7 8BL, England
Tel: 01908-366700

GERMANY

Yamaha Music Europe GmbH
Siemensstraße 22-34, 25462 Rellingen, Germany
Tel: 04101-3030

SWITZERLAND/LIECHTENSTEIN

Yamaha Music Europe GmbH
Branch Switzerland in Zürich
Seefeldstrasse 94, 8008 Zürich, Switzerland
Tel: 01-383 3990

AUSTRIA

Yamaha Music Europe GmbH Branch Austria
Schleiergasse 20, A-1100 Wien, Austria
Tel: 01-60203900

CZECH REPUBLIC/SLOVAKIA/ HUNGARY/SLOVENIA

Yamaha Music Europe GmbH Branch Austria
Schleiergasse 20, A-1100 Wien, Austria
Tel: 01-602039025

POLAND

Yamaha Music Europe GmbH
Branch Sp.z o.o. Oddział w Polsce
ul. 17 Stycznia 56, PL-02-146 Warszawa, Poland
Tel: 022-868-07-57

THE NETHERLANDS/ BELGIUM/LUXEMBOURG

Yamaha Music Europe Branch Benelux
Clarissenhof 5-b, 4133 AB Vianen, The Netherlands
Tel: 0347-358 040

FRANCE

Yamaha Musique France
BP 70-77312 Marne-la-Vallée Cedex 2, France
Tel: 01-64-61-4000

ITALY

Yamaha Musica Italia S.P.A.
Combo Division
Viale Italia 88, 20020 Lainate (Milano), Italy
Tel: 02-935-771

SPAIN/PORTUGAL

Yamaha Música Ibérica, S.A.
Ctra. de la Coruna km. 17, 200, 28230
Las Rozas (Madrid), Spain
Tel: 91-639-8888

GREECE

Philippou Nakas S.A. The Music House
147 Skiathou Street, 112-55 Athens, Greece
Tel: 01-228 2160

SWEDEN

Yamaha Scandinavia AB
J. A. Wettergrens Gata 1, Box 30053
S-400 43 Göteborg, Sweden
Tel: 031 89 34 00

DENMARK

YS Copenhagen Liaison Office
Generatorvej 6A, DK-2730 Herlev, Denmark
Tel: 44 92 49 00

FINLAND

F-Musiikki Oy
Kluuvikatu 6, P.O. Box 260,
SF-00101 Helsinki, Finland
Tel: 09 618511

NORWAY

Norsk filial av Yamaha Scandinavia AB
Grini Næringspark 1, N-1345 Østerås, Norway
Tel: 67 16 77 70

ICELAND

Skifan HF
Skeifan 17 P.O. Box 8120, IS-128 Reykjavik, Iceland
Tel: 525 5000

RUSSIA

Yamaha Music (Russia)
Office 4015, entrance 2, 21/5 Kuznetskii
Most street, Moscow, 107996, Russia
Tel: 495 626 0660

OTHER EUROPEAN COUNTRIES

Yamaha Music Europe GmbH
Siemensstraße 22-34, 25462 Rellingen, Germany
Tel: +49-4101-3030

AFRICA

Yamaha Corporation,
Asia-Pacific Music Marketing Group
Nakazawa-cho 10-1, Naka-ku, Hamamatsu,
Japan 430-8650
Tel: +81-53-460-2312

MIDDLE EAST

TURKEY/CYPRUS

Yamaha Music Europe GmbH
Siemensstraße 22-34, 25462 Rellingen, Germany
Tel: 04101-3030

OTHER COUNTRIES

Yamaha Music Gulf FZE
LOB 16-513, P.O.Box 17328, Jubel Ali,
Dubai, United Arab Emirates
Tel: +971-4-881-5868

ASIA

THE PEOPLE'S REPUBLIC OF CHINA

Yamaha Music & Electronics (China) Co., Ltd.
2F, Yunhedasha, 1818 Xinzha-lu, Jingan-qu,
Shanghai, China
Tel: 021-6247-2211

HONG KONG

Tom Lee Music Co., Ltd.
11/F., Silvercord Tower 1, 30 Canton Road,
Tsimshatsui, Kowloon, Hong Kong
Tel: 2737-7688

INDIA

Yamaha Music India Pvt. Ltd.
5F Ambience Corporate Tower Ambience Mall Complex
Ambience Island, NH-8, Gurgaon-122001, Haryana, India
Tel: 0124-466-5551

INDONESIA

PT. Yamaha Music Indonesia (Distributor)
PT. Nusantik
Gedung Yamaha Music Center, Jalan Jend. Gatot
Subroto Kav. 4, Jakarta 12930, Indonesia
Tel: 21-520-2577

KOREA

Yamaha Music Korea Ltd.
8F, 9F, Dongsung Bldg. 158-9 Samsung-Dong,
Kangnam-Gu, Seoul, Korea
Tel: 080-004-0022

MALAYSIA

Yamaha Music Malaysia, Sdn., Bhd.
Lot 8, Jalan Perbandaran, 47301 Kelana Jaya,
Petaling Jaya, Selangor, Malaysia
Tel: 3-78030900

PHILIPPINES

Yupangco Music Corporation
339 Gil J. Puyat Avenue, P.O. Box 885 MCPO,
Makati, Metro Manila, Philippines
Tel: 819-7551

SINGAPORE

Yamaha Music Asia Pte., Ltd.
#03-11 A-Z Building
140 Paya Lebar Road, Singapore 409015
Tel: 747-4374

TAIWAN

Yamaha KHS Music Co., Ltd.
3F, #6, Sec.2, Nan Jing E. Rd. Taipei.
Taiwan 104, R.O.C.
Tel: 02-2511-8688

THAILAND

Siam Music Yamaha Co., Ltd.
4, 6, 15 and 16th floor, Siam Motors Building,
891/1 Rama 1 Road, Wangmai,
Pathumwan, Bangkok 10330, Thailand
Tel: 02-215-2626

OTHER ASIAN COUNTRIES

Yamaha Corporation,
Asia-Pacific Music Marketing Group
Nakazawa-cho 10-1, Naka-ku, Hamamatsu,
Japan 430-8650
Tel: +81-53-460-2317

OCEANIA

AUSTRALIA

Yamaha Music Australia Pty. Ltd.
Level 1, 99 Queensbridge Street, Southbank,
Victoria 3006, Australia
Tel: 3-9693-5111

NEW ZEALAND

Music Works LTD
P.O. BOX 6246 Wellesley, Auckland 4680,
New Zealand
Tel: 9-634-0099

COUNTRIES AND TRUST TERRITORIES IN PACIFIC OCEAN

Yamaha Corporation,
Asia-Pacific Music Marketing Group
Nakazawa-cho 10-1, Naka-ku, Hamamatsu,
Japan 430-8650
Tel: +81-53-460-2312

HEAD OFFICE

Yamaha Corporation, Pro Audio & Digital Musical Instrument Division
Nakazawa-cho 10-1, Naka-ku, Hamamatsu, Japan 430-8650
Tel: +81-53-460-2445



Yamaha Web Site (English only)
<http://www.yamahasyth.com/>
Yamaha Manual Library
<http://www.yamaha.co.jp/manual/>