



DIGITAL PIANO  
**P - 105**

**Owner's Manual**

**EN**

## SPECIAL MESSAGE SECTION

This product utilizes batteries or an external power supply (adapter). DO NOT connect this product to any power supply or adapter other than one described in the manual, on the name plate, or specifically recommended by Yamaha.

**WARNING:** Do not place this product in a position where anyone could walk on, trip over, or roll anything over power or connecting cords of any kind. The use of an extension cord is not recommended! If you must use an extension cord, the minimum wire size for a 25' cord (or less) is 18 AWG. NOTE: The smaller the AWG number, the larger the current handling capacity. For longer extension cords, consult a local electrician.

This product should be used only with the components supplied or; a cart, rack, or stand that is recommended by Yamaha. If a cart, etc., is used, please observe all safety markings and instructions that accompany the accessory product.

### **SPECIFICATIONS SUBJECT TO CHANGE:**

The information contained in this manual is believed to be correct at the time of printing. However, Yamaha reserves the right to change or modify any of the specifications without notice or obligation to update existing units.

This product, either alone or in combination with an amplifier and headphones or speaker/s, may be capable of producing sound levels that could cause permanent hearing loss. DO NOT operate for long periods of time at a high volume level or at a level that is uncomfortable. If you experience any hearing loss or ringing in the ears, you should consult an audiologist.

**IMPORTANT:** The louder the sound, the shorter the time period before damage occurs.

Some Yamaha products may have benches and / or accessory mounting fixtures that are either supplied with the product or as optional accessories. Some of these items are designed to be dealer assembled or installed. Please make sure that benches are stable and any optional fixtures (where applicable) are well secured BEFORE using.

Benches supplied by Yamaha are designed for seating only. No other uses are recommended.

### **NOTICE:**

Service charges incurred due to a lack of knowledge relating to how a function or effect works (when the unit is operating as designed) are not covered by the manufacturer's warranty, and are therefore the owners responsibility. Please study this manual carefully and consult your dealer before requesting service.

### **ENVIRONMENTAL ISSUES:**

Yamaha strives to produce products that are both user safe and environmentally friendly. We sincerely believe that our products and the production methods used to produce them, meet these goals. In keeping with both the letter and the spirit of the law, we want you to be aware of the following:

### **Battery Notice:**

This product MAY contain a small non-rechargeable battery which (if applicable) is soldered in place. The average life span of this type of battery is approximately five years. When replacement becomes necessary, contact a qualified service representative to perform the replacement.

This product may also use "household" type batteries. Some of these may be rechargeable. Make sure that the battery being charged is a rechargeable type and that the charger is intended for the battery being charged.

When installing batteries, never mix old batteries with new ones, and never mix different types of batteries. Batteries MUST be installed correctly. Mismatches or incorrect installation may result in overheating and battery case rupture.

### **Warning:**

Do not attempt to disassemble, or incinerate any battery. Keep all batteries away from children. Dispose of used batteries promptly and as regulated by the laws in your area. Note: Check with any retailer of household type batteries in your area for battery disposal information.

### **Disposal Notice:**

Should this product become damaged beyond repair, or for some reason its useful life is considered to be at an end, please observe all local, state, and federal regulations that relate to the disposal of products that contain lead, batteries, plastics, etc. If your dealer is unable to assist you, please contact Yamaha directly.

### **NAME PLATE LOCATION:**

The name plate is located on the bottom of the product. The model number, serial number, power requirements, etc., are located on this plate. You should record the model number, serial number, and the date of purchase in the spaces provided below and retain this manual as a permanent record of your purchase.

**Model**

---

**Serial No.**

---

**Purchase Date**

---

## PLEASE KEEP THIS MANUAL

92-BP (bottom)

Thank you for purchasing this Yamaha Digital Piano!

We recommend that you read this manual carefully so that you can fully take advantage of the advanced and convenient functions of the instrument.

We also recommend that you keep this manual in a safe and handy place for future reference.

## Contents

Accessories.....	3	<b>Using the Metronome/Rhythm</b>	<b>15</b>
About the Manuals .....	4	Selecting a Beat (Time Signature).....	15
PRECAUTIONS .....	4	Selecting a Rhythm .....	15
<b>Introduction</b>		Adjusting the Tempo.....	15
<b>Panel Controls and Terminals</b>	<b>6</b>	Adjusting the Volume.....	15
<b>Setting Up</b>	<b>7</b>	<b>Recording Your Performance</b>	<b>16</b>
Turning the Power On/Off .....	7	Quick Recording.....	16
Setting the Volume.....	7	Recording Independently to Two Parts .....	16
Using Headphones .....	7	Changing the Initial Settings of the Recorded Song..	17
Connecting External Audio Equipment .....	7	Transferring SMF Files Between a Computer and this Instrument .....	17
Using a Footswitch.....	8	Deleting the Entire Song.....	18
Using the Optional Pedal Unit.....	8	<b>Song Playback and Practice</b>	<b>18</b>
<b>Reference</b>		<b>Backup Data and Initializing</b>	<b>19</b>
<b>Selecting &amp; Playing Voices</b>	<b>9</b>	<b>Auto Power Off Function</b>	<b>19</b>
Selecting a Voice .....	9	<b>Appendix</b>	
Layering Two Voices (Dual).....	9	<b>Troubleshooting</b>	<b>20</b>
Splitting the Keyboard (Split) .....	10	<b>Specifications</b>	<b>20</b>
Using the Pianist Styles .....	10	<b>Preset Song List</b>	<b>21</b>
Playing Duo.....	11	<b>Quick Operation Guide</b>	<b>22</b>
Adding Variations to the Sound – Reverb.....	12		
Setting the Touch Sensitivity.....	12		
Transposing the Pitch in Semitones .....	13		
Fine-Tuning the Pitch.....	13		
<b>Listening to the Songs</b>	<b>14</b>		
Listening to the Demo Songs.....	14		
Listening to the Preset Songs .....	14		

### Accessories

- Owner's Manual
- AC Power Adaptor\*
- Online Member Product Registration\*\*
- Footswitch

\* May not be included depending on your particular area. Please check with your Yamaha dealer.

\*\* The PRODUCT ID on the sheet will be needed when you fill out the User Registration form.

- Music Rest

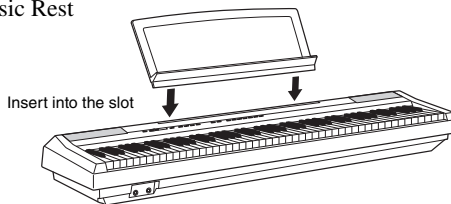

## About the Manuals

In addition to this Owner's Manual, the following Online materials (PDF files) are available.



### Computer-related Operations

Contains instructions about computer-related functions.



### MIDI Reference

Contains MIDI-related information, such as the MIDI Implementation Chart.



### MIDI Basics (only in English, French, German and Spanish)

Contains basic explanations about what MIDI is and can do.

To obtain the documents above, access the Yamaha Manual Library, enter your model name in the Model Name area, then click [SEARCH].

#### Yamaha Manual Library

<http://www.yamaha.co.jp/manual/>

# PRECAUTIONS

## PLEASE READ CAREFULLY BEFORE PROCEEDING

Please keep this manual in a safe and handy place for future reference.



## WARNING

Always follow the basic precautions listed below to avoid the possibility of serious injury or even death from electrical shock, short-circuiting, damages, fire or other hazards. These precautions include, but are not limited to, the following:

### Power supply/AC power adaptor

- Do not place the power cord near heat sources such as heaters or radiators. Also, do not excessively bend or otherwise damage the cord, or place heavy objects on it.
- Only use the voltage specified as correct for the instrument. The required voltage is printed on the name plate of the instrument.
- Use the specified adaptor (page 20) only. Using the wrong adaptor can result in damage to the instrument or overheating.
- Check the electric plug periodically and remove any dirt or dust which may have accumulated on it.

### Do not open

- This instrument contains no user-serviceable parts. Do not open the instrument or attempt to disassemble or modify the internal components in any way. If it should appear to be malfunctioning, discontinue use immediately and have it inspected by qualified Yamaha service personnel.

### Water warning

- Do not expose the instrument to rain, use it near water or in damp or wet conditions, place on it any containers (such as vases, bottles or glasses) containing liquids which might spill into any openings. If any liquid such as water seeps into the instrument, turn off the power immediately and unplug the power cord from the AC outlet. Then have the instrument inspected by qualified Yamaha service personnel.
- Never insert or remove an electric plug with wet hands.

### Fire warning

- Do not put burning items, such as candles, on the unit. A burning item may fall over and cause a fire.

### If you notice any abnormality

- When one of the following problems occur, immediately turn off the power switch and disconnect the electric plug from the outlet. Then have the device inspected by Yamaha service personnel.
  - The power cord or plug becomes frayed or damaged.
  - It emits unusual smells or smoke.
  - Some object has been dropped into the instrument.
  - There is a sudden loss of sound during use of the instrument.

## **CAUTION**

**Always follow the basic precautions listed below to avoid the possibility of physical injury to you or others, or damage to the instrument or other property. These precautions include, but are not limited to, the following:**

### **Power supply/AC power adaptor**

- Do not connect the instrument to an electrical outlet using a multiple-connector. Doing so can result in lower sound quality, or possibly cause overheating in the outlet.
- When removing the electric plug from the instrument or an outlet, always hold the plug itself and not the cord. Pulling by the cord can damage it.
- Remove the electric plug from the outlet when the instrument is not to be used for extended periods of time, or during electrical storms.

### **Location**

- Do not place the instrument in an unstable position where it might accidentally fall over.
- Before moving the instrument, remove all connected cables, to prevent damage to the cables or injury to anyone who might trip over them.
- When setting up the product, make sure that the AC outlet you are using is easily accessible. If some trouble or malfunction occurs, immediately turn off the power switch and disconnect the plug from the outlet. Even when the power switch is turned off, electricity is still flowing to the product at the minimum level. When you are not using the product for a long time, make sure to unplug the power cord from the wall AC outlet.
- Use only the stand specified for the instrument. When attaching the stand or rack, use the provided screws only. Failure to do so could cause damage to the internal components or result in the instrument falling over.

### **Connections**

- Before connecting the instrument to other electronic components, turn off the power for all components. Before turning the power on or off for all components, set all volume levels to minimum.
- Be sure to set the volumes of all components at their minimum levels and gradually raise the volume controls while playing the instrument to set the desired listening level.

### **Handling caution**

- Do not insert a finger or hand in any gaps on the instrument.
- Never insert or drop paper, metallic, or other objects into the gaps on the panel or keyboard. This could cause physical injury to you or others, damage to the instrument or other property, or operational failure.
- Do not rest your weight on, or place heavy objects on the instrument, and do not use excessive force on the buttons, switches or connectors.
- Do not use the instrument/device or headphones for a long period of time at a high or uncomfortable volume level, since this can cause permanent hearing loss. If you experience any hearing loss or ringing in the ears, consult a physician.

Yamaha cannot be held responsible for damage caused by improper use or modifications to the instrument, or data that is lost or destroyed.

Always turn the power off when the instrument is not in use.

Even when the [  ] (Standby/On) switch is in standby status (power lamp is off), electricity is still flowing to the instrument at the minimum level.

When you are not using the instrument for a long time, make sure you unplug the power cord from the wall AC outlet.

## **Notice**

To avoid the possibility of malfunction/ damage to the product, damage to data, or damage to other property, follow the notices below.

### **■ Handling and Maintenance**

- Do not use the instrument in the vicinity of a TV, radio, stereo equipment, mobile phone, or other electric devices. Otherwise, the instrument, TV, or radio may generate noise.
- Do not expose the instrument to excessive dust or vibrations, or extreme cold or heat (such as in direct sunlight, near a heater, or in a car during the day) to prevent the possibility of panel disfiguration, damage to the internal components or unstable operation. (Verified operating temperature range: 5° – 40°C, or 41° – 104°F.)
- Do not place vinyl, plastic or rubber objects on the instrument, since this might discolor the panel or keyboard.
- When cleaning the instrument, use a soft, dry/dry or slightly damp cloth. Do not use paint thinners, solvents, cleaning fluids, or chemical-impregnated wiping cloths.

### **■ Saving data**

- Some types of data (page 19) will be stored in internal memory, and maintained even if the power is turned off. However, the data could be lost due to malfunction or incorrect operation. Save important data to a computer. For details, refer to the Computer-related Operations (page 4).

## **Information**

### **■ About copyrights**

- Copying of the commercially available musical data including but not limited to MIDI data and/or audio data is strictly prohibited except for your personal use.
- This product incorporates and bundles computer programs and contents in which Yamaha owns copyrights or with respect to which it has license to use others' copyrights. Such copyrighted materials include, without limitation, all computer software, style files, MIDI files, WAVE data, musical scores and sound recordings. Any unauthorized use of such programs and contents outside of personal use is not permitted under relevant laws. Any violation of copyright has legal consequences. DON'T MAKE, DISTRIBUTE OR USE ILLEGAL COPIES.

### **■ About functions/data bundled with the instrument**

- Some of the preset songs have been edited for length or arrangement, and may not be exactly the same as the original.

### **■ About this manual**

- The illustrations and LCD screens as shown in this manual are for instructional purposes only, and may appear somewhat different from those on your instrument.
- The company names and product names in this manual are the trademarks or registered trademarks of their respective companies.

# Panel Controls and Terminals

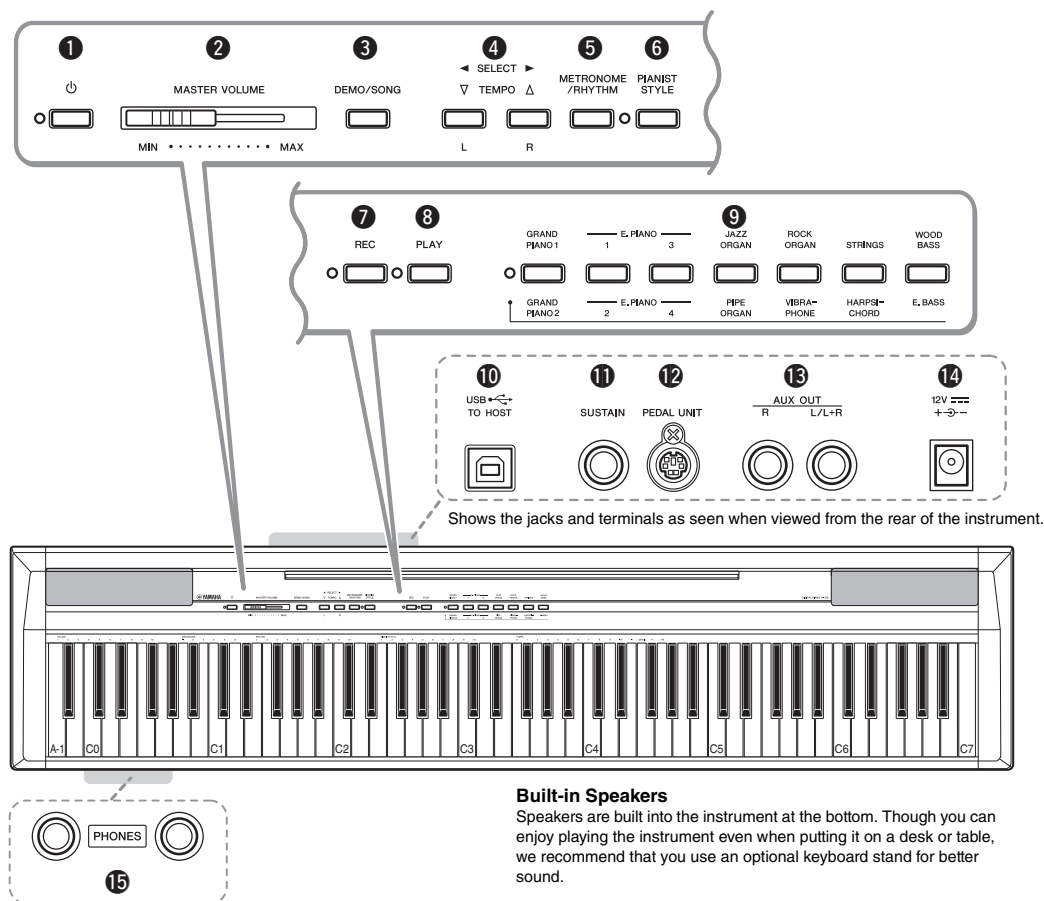

## Built-in Speakers

Speakers are built into the instrument at the bottom. Though you can enjoy playing the instrument even when putting it on a desk or table, we recommend that you use an optional keyboard stand for better sound.

- 1 [⏻] (Standby/On) switch ..... page 7**  
For turning the power on or setting to standby.
- 2 [MASTER VOLUME] slider ..... page 7**  
For adjusting the volume of the entire sound.
- 3 [DEMO/SONG] button .....page 14**  
For playing the Demo Songs and the Preset Songs.
- 4 [TEMPO] [▽][△]/[SELECT] [◀][▶] buttons .....page 14**  
For selecting a Song during playback, adjusting the tempo, and selecting the Song part for recording and playback.
- 5 [METRONOME/RHYTHM] button.....page 15**  
For starting or stopping the metronome or rhythm.
- 6 [PIANIST STYLE] button .....page 10**  
For using the Pianist Styles.
- 7 [REC] button .....page 16**  
For recording your keyboard performance.
- 8 [PLAY] button .....page 16**  
For playing back the recorded performance.
- 9 Voice buttons..... page 9**  
For switching the Voice between those printed above and below each button.

For selecting a Voice or two Voices played simultaneously, such as Piano and Organ.

- 10 [USB TO HOST] terminal**  
For connecting to a computer, allowing you transfer the User Song data as SMF, and transmit MIDI messages between both devices. For details, refer to the “Computer-related Operations” and the “MIDI Reference.”
- NOTICE**  
• Use an AB type USB cable of less than 3 meters. USB 3.0 cables cannot be used.
- 11 [SUSTAIN] jack .....page 8**  
For connecting the included footswitch, an optional footswitch and foot pedal.
- 12 [PEDAL UNIT] jack .....page 8**  
For connecting an optional pedal unit.
- 13 AUX OUT [L/L+R][R] jacks .....page 7**  
For connecting external audio equipment.
- 14 DC IN jack .....page 7**  
For connecting the power adaptor.
- 15 [PHONES] jacks .....page 7**  
For connecting a set of standard stereo headphones.

# Setting Up

## Turning the Power On/Off

- 1 Connect the AC power adaptor to the DC IN jack.

### ⚠ WARNING

- Use only the specified adaptor (page 20). Using the wrong adaptor can result in damage to the instrument or overheating.

- 2 Plug the AC power adaptor into an AC outlet.
- 3 Press the [⏻] (Standby/On) switch to turn on the power.

The power lamp located to the left of the [⏻] (Standby/On) switch lights up. To turn off the power, press this switch again.

### ⚠ CAUTION

- Even when the [⏻] (Standby/On) switch is in standby status (power lamp is off), electricity is still flowing to the instrument at the minimum level. When you are not using the instrument for a long time, make sure you unplug the power cord from the wall AC outlet.

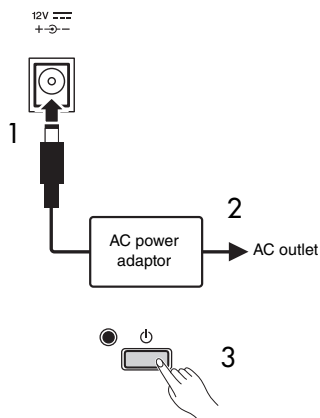

### IMPORTANT

- Note that the power is automatically turned off if this instrument is not operated for 30 minutes. For details, see page 19.

## Setting the Volume

When you start playing, use the [MASTER VOLUME] slider to adjust the volume of the entire keyboard sound.

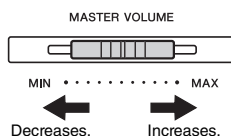

## I.A. Control (Intelligent Acoustic Control)

With this function, the sound quality of this instrument is automatically adjusted and controlled according to the overall volume. Even when the volume is low, you can hear both low sounds and high sounds clearly.

### To turn on/off the I.A. Control:

While holding down [DEMO/SONG] and [METRONOME/RHYTHM] simultaneously, press the C#5 key to turn on or D5 to turn off. The default setting is “on”.

### To adjust the I.A. Control Depth:

While holding down [DEMO/SONG] and [METRONOME/RHYTHM] simultaneously, press the A#4 key to decrease by one, C5 to increase by one, or B4 to reset to 0 (default). The setting range is from -3 to +3.

For details on the key assignments, see “Quick Operation Guide” (page 22).

## Using Headphones

Since this instrument is equipped with two [PHONES] jacks, you can connect two sets of standard stereo headphones. If you are using only one set of headphones, insert a plug into either jack, shutting off the speakers.

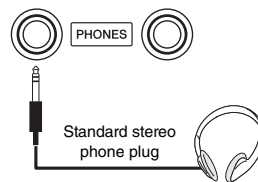

### ⚠ CAUTION

- To protect your hearing, avoid listening with the headphones at a high volume level for long periods of time.

## Connecting External Audio Equipment

To amplify the instrument’s sound, you can connect a stereo system to the AUX OUT [L/L+R]/[R] jacks via the Phone plugs (standard). The volume of the sound output from those jacks will be adjusted via the [MASTER VOLUME] slider.

### NOTICE

- When the instrument’s sound is output to an external device, first turn on the power to the instrument, then to the external device. Reverse this order when you turn the power off.

### NOTE

- Use audio cables and adaptor plugs having no (zero) resistance.
- Use only the [L/L+R] jack for connection with a monaural device.

## Using a Footswitch

The [SUSTAIN] jack is for connecting the included footswitch, which works in the same way as a damper pedal on an acoustic piano. Also an optional FC3 foot pedal or FC4/FC5 footswitch can be connected to this jack. The FC3 lets you use the Half Pedal function.

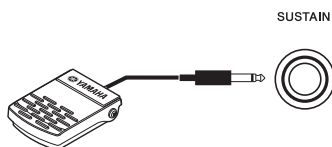

### Half Pedal function (for FC3 and LP-5A/LP-5AWH)

If you are playing the piano with sustain and want a clearer, less muddled sound (especially in the bass register), let up on your foot from the pedal to half position or higher.

**NOTE**

- Do not press the footswitch when turning the power on. Doing this changes the recognized polarity of the footswitch, resulting in reversed footswitch operation.
- Make sure that power is OFF when connecting or disconnecting the footswitch or pedal.

## Using the Optional Pedal Unit

The [PEDAL UNIT] jack is for connecting an optional LP-5A/LP-5AWH pedal unit. When connecting the pedal unit, make sure to also assemble the unit on an optional keyboard stand (L-85/L-85S/L-85WH).

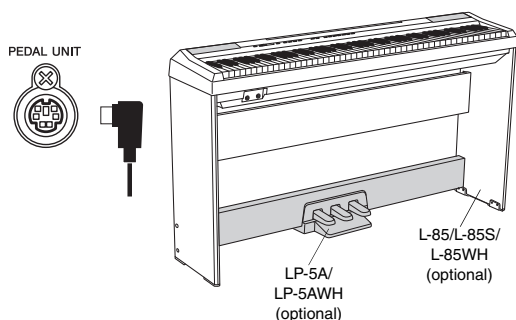

**NOTE**

- Make sure that power is OFF when connecting or disconnecting the pedal unit.
- The Damper Resonance cannot be used in Duo (page 11).

## Damper (Right) Pedal

Pressing this pedal will sustain notes longer. Releasing this pedal immediately stops (damps) any sustained notes. A “half-pedal” function of this pedal creates partial sustain effects, depending on how far down you press the pedal.

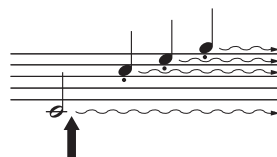

### Damper Resonance

This function simulates the sustain sound produced via the damper pedal on a grand piano.

#### To turn on/off the Damper Resonance:

While holding down [DEMO/SONG] and [METRONOME/RHYTHM] simultaneously, press the G4 key (on; default) or G#4 key (off).

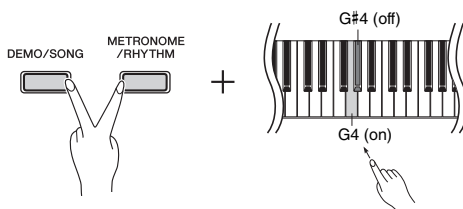

## Sostenuto (Center) Pedal

If you play a note or chord on the keyboard and press the sostenuto pedal while the note(s) are held, those notes will sustain as long as you hold the pedal (as if the damper pedal had been pressed) but all subsequently played notes will not be sustained. This makes it possible to sustain a chord, for example, while other notes are played “staccato.”

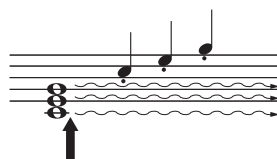

## Soft (Left) Pedal

The soft pedal reduces the volume and slightly changes the timbre of notes played while the pedal is pressed. The soft pedal will not affect notes that are already playing when it is pressed.

**NOTE**

- When you select the JAZZ ORGAN or ROCK ORGAN Voice, the Left pedal functions to switch the rotary speed of the rotary speaker.



# Selecting & Playing Voices

## Selecting a Voice

The instrument has a wide variety of Voices, or instrument sounds, for your enjoyment, including Piano and Organ.

### 1 Press a Voice button once or twice.

Pressing the same Voice button repeatedly alternates the on/off status of the lamp, changing between the Voices whose names are printed above (lamp off) and below (lamp on) the buttons.

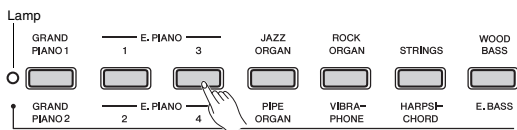

#### Voice List

Voice Name	Description
GRAND PIANO 1	Sampled from a concert grand piano. It uses different samples depending on the playing strength and produces smoother tonal changes. Suitable not only for classical compositions but also for any style music.
GRAND PIANO 2	Spacious and clear piano with bright reverb. Good for popular music.
E. PIANO 1	An electronic piano sound created by FM synthesis. Good for standard popular music.
E. PIANO 2	A slightly brighter electronic piano sound than E. PIANO 1. Good for standard popular music.
E. PIANO 3	Vintage electric piano sound of hammer-struck metallic "tines." Soft tone when played lightly, and an aggressive tone when played hard.
E. PIANO 4	Another vintage electric piano sound different from E. PIANO 3 often heard in rock and popular music.
JAZZ ORGAN	A "tonewheel" type electric organ. Often heard in jazz and rock music.
PIPE ORGAN	A typical pipe organ sound (8 feet + 4 feet + 2 feet). Good for sacred music from the Baroque period.
ROCK ORGAN	Bright and edgy electric organ sound. Good for rock music.
VIBRAPHONE	Played with relatively soft mallets. The tone becomes more metallic the harder you play.
STRINGS	Stereo-sampled, large-scale strings ensemble with realistic reverb. Try combining this Voice with piano in the Dual mode.
HARPSI-CHORD	The definitive instrument for baroque music. Authentic harpsichord sound, with plucked strings, no touch response, and characteristic key-release sound.
WOOD BASS	An upright bass played fingerstyle. Ideal for jazz and Latin music.
E. BASS	For a wide range of music styles, jazz, rock, popular, and more.

## 2 Play the keyboard.

#### NOTE

- To familiarize yourself with the characteristics of the voices, listen to the demo songs for each voice (page 14).
- You can shift the Octave as described in the next column (see "Voice 1").

## Layering Two Voices (Dual)

You can play Voices simultaneously across the entire range of the keyboard. Note that the Voice of the left side button is designated as Voice 1, while the Voice of the right side button is designated as Voice 2.

#### NOTE

- Two Voices of the same button cannot be layered (for example, STRINGS and HARPSICHORD).

### 1 Engage Dual.

Press the desired Voice button once or twice (depending on the desired Voice), then while holding down that button, press the other Voice button once or twice. When the lamp is off, the Voice printed above the button is selected; when the lamp is on, the Voice printed below is selected. When the buttons are released, Dual is engaged. The lamp indicates the status of the Voice 1 selection.

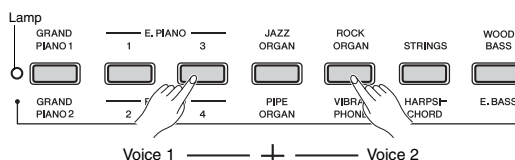

## 2 Play the keyboard to enjoy the dual sound.

### To shift the Octave for each Voice:

To shift Voice 1, simultaneously hold down [METRONOME/RHYTHM] and press the A4 key to lower by one, B4 to raise by one, or A#4 to reset to the default setting. For Voice 2, simultaneously hold down [METRONOME/RHYTHM] and press the C5 key to lower by one, D5 to raise by one, or C#5 to reset to the default setting. The setting range is from -3 to +3 for both Voices.

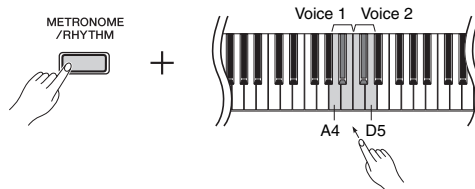

**To adjust the balance between two Voices:**

While holding down [METRONOME/RHYTHM], press the E5 key to decrease by one, F#5 to increase by one, or F5 to reset to the default setting. The setting range is from -6 to +6. Settings above the default increase the volume of Voice1, and vice versa.

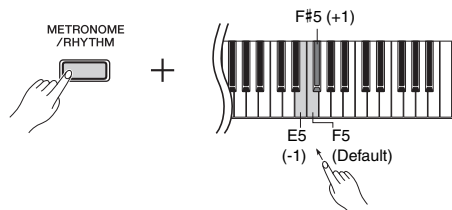

**3 To exit from Dual, simply press any Voice button.**

**Splitting the Keyboard (Split)**

You can play different Voices your left and right hands.

**1 While holding [L], press a Voice button to engage Split.**

The Left Voice (Voice 2) is selected. The keyboard is divided into the two sections with the F#2 key as the Split Point.

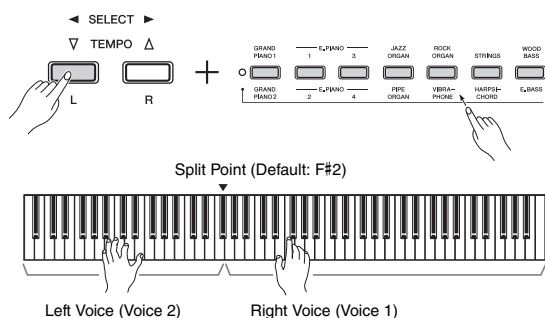

**NOTE**  
• Only Dual or Split can be called up; both cannot be used together.

**2 To change the Right Voice (Voice 1) in this status, select a Voice while holding [R].**

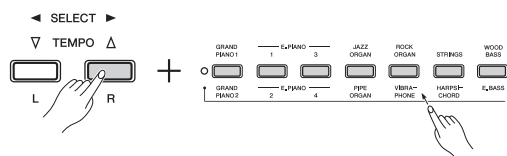

**To shift the Octave for each Voice:**

Same as in Dual (page 9).

**To adjust the volume balance between two Voices:**

Same as in Dual (see column at left).

**To change the Split Point:**

While holding [L], press the desired key.

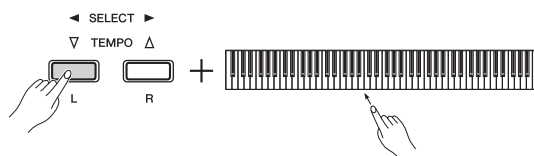

**3 To exit from Split, simply press any Voice button.**

**Using the Pianist Styles**

You can automatically play arpeggio-like rhythms by specifying the chord type with your left hand, while playing a melody with your right hand.

**1 Press [PIANIST STYLE] so that the lamp flashes.**

The keyboard is divided into the Chord section (Left) and Melody section (Right).

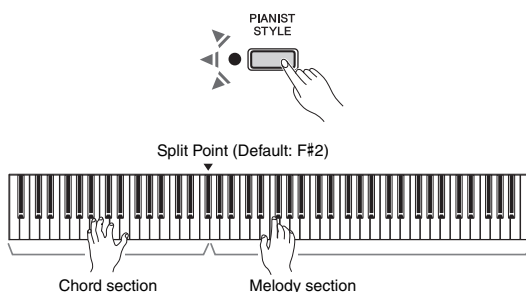

**2 While holding [PIANIST STYLE], press a key from the E2 – C#3 to select the desired Style.**

For details on which Pianist Style is assigned to each key, see “Quick Operation Guide” (page 22).

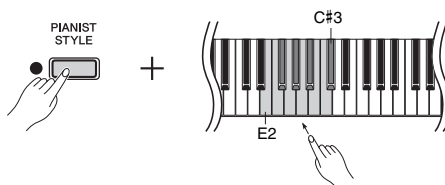

### 3 Play a chord with your left hand to start playback of the Pianist Style.

Play a melody with your right hand, along with the chords you play.

**NOTE**

- For details on how to play Chords, refer to commercially available chord books.

#### To change the tempo:

Basically, this is the same as Metronome tempo (page 15). In addition, you can change the tempo also by pressing the specified keys while holding [PIANIST STYLE]. For details about the key assignment, refer to the Quick Operation Guide (page 22).

#### To adjust the Pianist Style Volume:

While holding down [PIANIST STYLE], press one of the A-1 – F#0 keys. The higher the key, the higher the volume. The default value is 7 (D#-1).

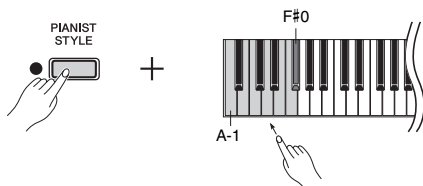

**NOTE**

- Refer to the numbers 1 – 10 printed in the VOLUME section above the keyboard.

### 4 Press [PIANIST STYLE] to stop playback.

The lamp turns off, and the keyboard returns to the original status.

#### To change the Split Point:

Same as in Split (page 10).

## Playing Duo

This function allows two different players to play the instrument, one on the left and the other on the right, over the same octave range.

### 1 While holding down [DEMO/SONG] and [METRONOME/RHYTHM] simultaneously, press the G6 key to engage Duo.

The keyboard is divided into two sections, with the E3 key as the Split Point.

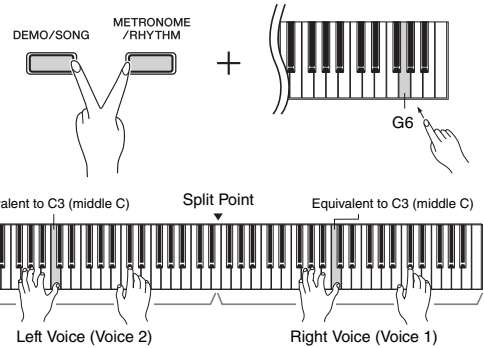

**NOTE**

- The Split Point cannot be changed from E3.
- If the keyboard is in Dual, engaging Duo will exit from Dual. The Voice 1 is used as the Voice of the entire keyboard.

### 2 One person should play the left section of the keyboard while the other plays the right.

#### To change the Left Voice:

While holding down [L], press a Voice button once or twice.

#### To change the Right Voice:

While holding down [R], press a Voice button once or twice.

#### To change the Right and Left Voices to the same single Voice:

Simply press the Voice button once or twice.

#### To shift the Octave for each Voice:

Same as in Dual (page 9).

#### To adjust the volume balance between two keyboard sections:

Same as in Dual (page 10).

#### Pedal function in Duo

The Footswitch connected to the [SUSTAIN] jack affects both Right and Left sections. The optional Pedal unit (page 8) functions as follows:

- Damper Pedal: Applies Sustain to the right section.
- Sostenuto Pedal: Applies Sustain to both sections.
- Soft Pedal: Applies Sustain to the left section.

### 3 To exit from Duo, press the G6 key while holding [DEMO/SONG] and [METRONOME/RHYTHM] simultaneously.

## Adding Variations to the Sound – Reverb

This instrument features several Reverb Types that add extra depth and expression to the sound to create a realistic acoustic ambience. Although the appropriate Reverb Type is called up automatically when you select each of the Voices, Songs, and Pianist Styles, you can change the Reverb Type.

### To select a Reverb Type:

While holding down [METRONOME/RHYTHM], press one of the G#6 – C7 keys.

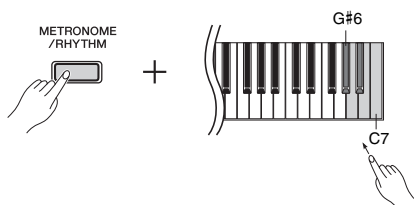

### Reverb Type List

Key	Reverb Type	Description
G#6	Room	Adds a continuous reverb effect to the sound, similar to the acoustic reverberation you would hear in a room.
A6	Hall1	For a bigger reverb sound. This effect simulates the natural reverberation of a small-size concert hall.
A#6	Hall2	For a truly spacious reverb sound. This effect simulates the natural reverberation of a large concert hall.
B6	Stage	Simulates the reverb of a stage environment.
C7	Off	No effect is applied.

### To adjust Reverb Depth:

While holding down [METRONOME/RHYTHM], press the F6 key to decrease by one, G6 to increase by one, or F#6 to reset to the default value (most suitable value for the current Voice). The higher the value, the deeper the effect. The setting range is from 0 (no effect) – 20 (maximum depth).

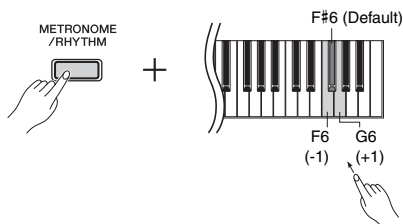

## Setting the Touch Sensitivity

You can specify the degree of Touch Sensitivity (how the sound responds to your playing strength).

While holding down [DEMO/SONG] and [METRONOME/RHYTHM], press one of the A6 – C7 keys.

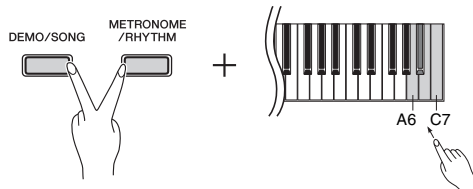

Key	Touch Sensitivity	Description
A6	Fixed	The volume level does not change at all regardless of whether you play the keyboard soft or hard.
A#6	Soft	The volume level does not change much when you play the keyboard soft or hard.
B6	Medium	This is the standard piano touch response (default setting).
C7	Hard	The volume level changes very widely from pianissimo to fortissimo to facilitate dynamic and dramatic expression. You have to hit the keys hard to produce a loud sound.

### NOTE

- The touch sensitivity settings may have little or no effect with JAZZ ORGAN, ROCK ORGAN, PIPE ORGAN and HARPSICHORD—voices that are not normally responsive to keyboard dynamics.

## Transposing the Pitch in Semitones

You can shift the pitch of the entire keyboard up or down in semitones in order to facilitate playing in difficult key signatures, or to easily match the pitch of the keyboard to the range of a singer or other instruments. For example, if “+5” is selected, playing key C produces pitch F, letting you play a song of F major as though it were in C major.

### To transpose the pitch down:

While holding down [DEMO/SONG] and [METRONOME/RHYTHM], press a key between F#3 (-6) and B3 (-1).

### To transpose the pitch up:

While holding down [DEMO/SONG] and [METRONOME/RHYTHM], press a key between C#4 (+1) and F#4 (+6).

### To restore the original pitch:

While holding down [DEMO/SONG] and [METRONOME/RHYTHM], press the C4 key.

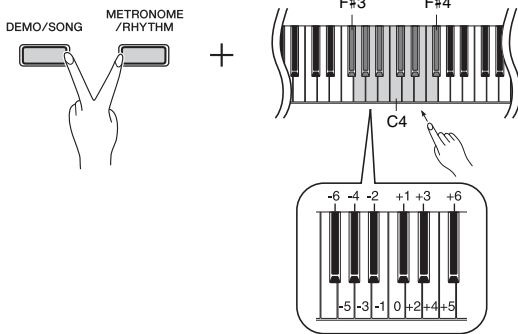

## Fine-Tuning the Pitch

You can fine tune the pitch of the entire instrument in approximately 0.2 Hz increments. This lets you match the keyboard pitch finely to that of other instruments or CD music.

### To lower the pitch:

While holding down [DEMO/SONG] and [METRONOME/RHYTHM], press the C#0 key repeatedly to lower the pitch in approximately 0.2 Hz increments.

### To raise the pitch:

While holding down [DEMO/SONG] and [METRONOME/RHYTHM], press the D0 key repeatedly to raise the pitch in approximately 0.2 Hz increments.

### To reset the pitch to the default (A3 = 440 Hz):

While holding down [DEMO/SONG] and [METRONOME/RHYTHM], press the B-1 key.

### To set the pitch to A3 = 442 Hz:

While holding down [DEMO/SONG] and [METRONOME/RHYTHM], press the C0 key.

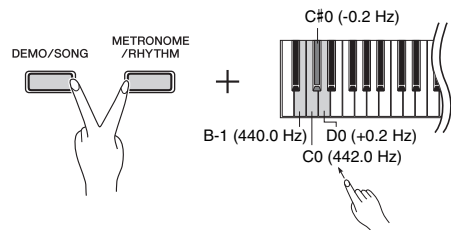

#### NOTE

- The setting range is from 427.0 Hz to 453.0 Hz. The default setting is A3 = 440.0 Hz.

# Listening to the Songs

## Listening to the Demo Songs

Special individual Demo Songs are provided for all of the Voices of the instrument.

- 1 While holding down [DEMO/SONG], press one of the desired Voice buttons once or twice, then release the buttons to start playback.

Pressing the same Voice button repeatedly alternates the on/off status of the lamp, changing between the Voices whose names are printed above (lamp off) and below (lamp on) the buttons. After selecting a Voice, release both buttons to start playback. A Demo Song for each Voice will play back in sequence (from left to right).

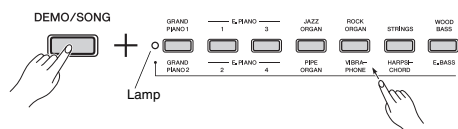

### NOTE

- Simply pressing [DEMO/SONG] will start playback of all Demo Songs from the first (Grand Piano 1) in sequence.

### To change the Demo Song during playback:

- Select another Voice. For details on selecting a Voice, refer to page 9.
- Press SELECT [◀] or [▶] to call up the previous or next Demo Song.

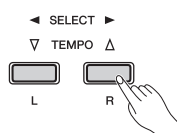

### To adjust the playback tempo:

While holding down [METRONOME/RHYTHM], press TEMPO [▽] or [△] to decrease or increase by one.

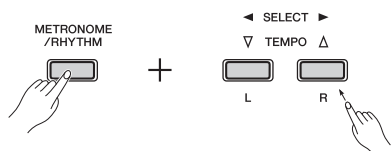

### Demo Song List

Voice Name	Title	Composer
PIPE ORGAN	Herr Christ, der ein'ge Gottes-Sohn, BWV.601	J.S. Bach
HARPSI-CHORD	Concerto a cembalo obbligato, 2 violini, violae continuo No.7, BWV.1058	J.S. Bach

The demonstration pieces listed above are short rearranged excerpts of the original compositions. All other songs are original (© 2012 Yamaha Corporation).

- 2 Press [DEMO/SONG] again to stop playback.

## Listening to the Preset Songs

In addition to the Demo Songs, Preset Songs are provided for your listening pleasure. Choose a Song from the Preset Song List on page 21, then follow the instructions below.

- 1 While holding down [DEMO/SONG], press one of the C2 – C#6 keys to start playback.

Each of the Preset Songs is assigned to each of these keys. For details on assignment, see “Quick Operation Guide” (page 22).

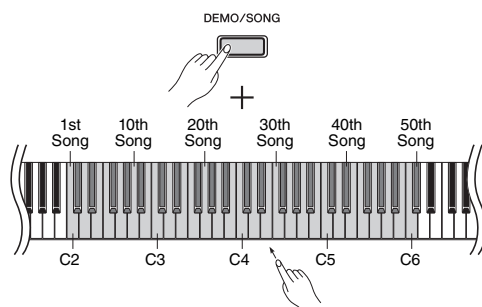

The Preset Songs will play back in sequence.

### To change to another Song during playback:

- While holding down [DEMO/SONG], press one of the C2 – C#6 keys.
- Press SELECT [◀] or [▶] to call up the previous or next Demo Song.

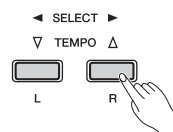

### To adjust the playback tempo:

While holding down [METRONOME/RHYTHM], press TEMPO [▽] or [△].

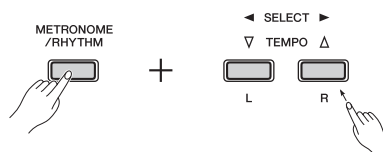

- 2 Press [DEMO/SONG] again to stop playback.

# Using the Metronome/Rhythm

The Metronome is convenient for practicing with an accurate tempo. The Metronome sound features several rhythms as well as the conventional click sound.

1 Press [METRONOME/RHYTHM] to start the Metronome.



2 Press [METRONOME/RHYTHM] again to stop the Metronome.

## Selecting a Beat (Time Signature)

While holding down [METRONOME/RHYTHM], press one of the A0 – D1 keys or one of the Voice buttons.

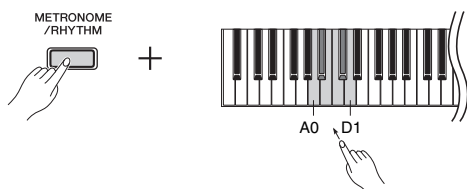

\*Refer to the "METRONOME" section printed above these keys.

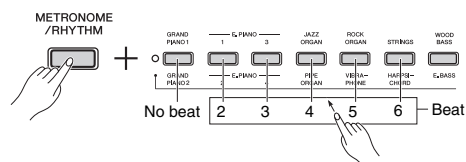

### NOTE

- When a Rhythm is selected, the Beat cannot be changed.

## Selecting a Rhythm

While holding down [METRONOME/RHYTHM], press one of the E1 – C#2 keys.

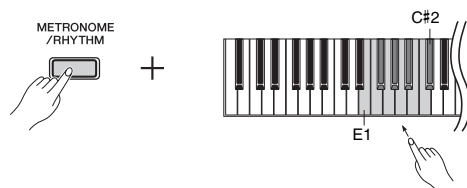

For details on which Rhythm number is assigned to each key, see "Quick Operation Guide" (page 22).

## Adjusting the Tempo

To increase or decrease the value by 1:

When the Metronome/Rhythm is playing back, press TEMPO [▽] or [△]. When it is stopped, press TEMPO [▽] or [△] while holding down [METRONOME/RHYTHM].

To increase or decrease the value by 1 or 10:

While holding down [METRONOME/RHYTHM], press one of the D#4 – G4.

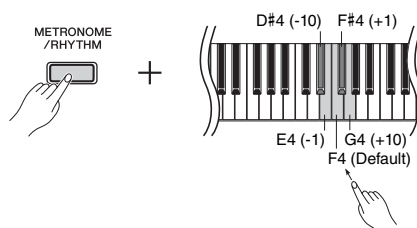

\* Refer to the "TEMPO" section printed above these keys.

To reset the value to the default (120):

When the Metronome/Rhythm is playing back, press both TEMPO [▽] and [△] simultaneously. When it is stopped, press both TEMPO [▽] and [△] simultaneously or press the F4 key while holding down [METRONOME/RHYTHM].

To specify a three-digit value:

While holding down [METRONOME/RHYTHM], press a key of F3 – D4 one by one. For example, press the F3 (0), D4 (9) and A#3 (5) keys in order to specify "95."

### NOTE

- Refer to the "TEMPO" section printed above these keys.

## Adjusting the Volume

While holding down [METRONOME/RHYTHM], press the desired key between the A-1 (left-most key) and F#0 key. The higher the key, the higher the volume. The setting range is from 1 – 10 and the default value is 7.

### NOTE

- Refer to the "VOLUME" section printed above the keys.

# Recording Your Performance

You can record your keyboard performance as a User Song in SMF format. Up to two Parts (L and R) can be recorded separately.

## NOTICE

- Note that the Recording operation will replace the already recorded data with the new data, since only one User Song is available. Before recording, check the [PLAY] lamp lights (data available) or not (no data). If you save the recorded data, transfer it to the computer as a SMF file. For details, refer to "Computer-related Operations" (page 4).

## Quick Recording

### 1 Before recording, make the settings such as Voice and Beat.

Because some of the settings cannot be changed after the Record mode is engaged, make the settings according to your performance preferences. For example, if you want to record your performance with a Pianist Style, turn on [PIANIST STYLE].

### 2 Press the [REC] to engage Record Ready mode.

The [REC] lamp will flash according to the current tempo. If necessary, set the tempo (page 15).

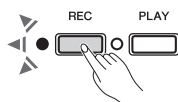

## NOTE

- You cannot engage Record mode while a song is playing.
- You can use the Metronome/Rhythm while recording; however, the Metronome/Rhythm sound will not be recorded. When you record the Pianist Style performance, the Metronome/Rhythm cannot be played back while recording.

### 3 Play the keyboard or press [PLAY] to start recording.

The [REC] lamp lights up while the [PLAY] lamp flashes at the current tempo.

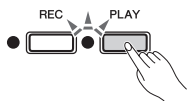

Play the keyboard and record your performance.



### 4 Press either [REC] or [PLAY] to stop recording.

The [REC] and [PLAY] lamps flash, indicating that the recorded data is being stored. After Store is completed, the [REC] lamp turns off.

## NOTICE

- Never turn off the power while the recorded data is being stored (while the lamps are flashing). Otherwise, all recorded data will be lost.

### 5 To hear the recorded Song, press [PLAY] to start playback.

Press [PLAY] again to stop playback.

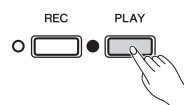

## Part Assignment

When either the Pianist Style or Split/Duo is used for recording, the data as listed below will be recorded to each part.

	L part	R part
When Pianist Style is on:	Chord change in the left hand section	Keyboard performance in the right hand section
When Split or Duo is on:	Keyboard performance in the left hand section	Keyboard performance in the right hand section

## Recording Independently to Two Parts

You can record your performance to the L part (left hand part) and R part (right hand part) separately.

## NOTICE

- If you select a Part containing data, the Recording operation will replace the already-recorded data with the new data.

## NOTE

- If you want to record your performance using Pianist Style, Split or Duo, use the Quick Recording method (in the previous section), since the instructions below do not apply to these functions.

### 1 Before recording, make the settings such as Voice and Beat.

### 2 While holding down [REC], press [R] or [L] for the part you want to record, to engage Record ready Mode.



### To record the right part ([R]):

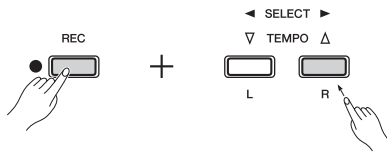

### To record the left part ([L]):

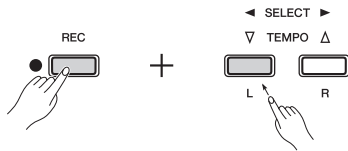

After a while, the [REC] lamp will flash at the current tempo. If necessary, set the tempo (page 15).

#### If data has already been recorded to the other Part:

The data in this Part will be played back while recording. This Part can be turned off or on by pressing this Part button while holding down [PLAY].

#### NOTE

- You can use the Metronome/Rhythm while recording; however, the Metronome/Rhythm sound will not be recorded.

### 3 Start recording.

Play the keyboard or press [PLAY] to start recording. The [REC] lamp lights up while the [PLAY] lamp flashes at the current tempo.

### 4 Press either [REC] or [PLAY] to stop recording.

The [REC] and [PLAY] lamps flash, indicating that the recorded data is being stored. After the operation is completed, the [REC] lamp will be turned off.

#### NOTICE

- Never turn off the power while the recorded data is being stored (while the lamps are flashing). Otherwise, all recorded data will be lost.

### 5 If desired, record the other part by repeating Steps 1 – 4.

### 6 To hear the recorded Song, Press [PLAY] to start playback.

Press [PLAY] again to stop playback.

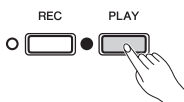

## Changing the Initial Settings of the Recorded Song

The following parameter settings of the Song can be changed after the Record operation is completed.

#### For individual parts:

Voice, Balance, Reverb Depth, Pedal (Damper/Soft)

#### For the entire Song:

Tempo, Reverb Type, Pianist Style Volume

### 1 Make the settings of the above parameters.

### 2 While holding down [REC], press the desired Part button to engage Record Ready mode.

If you want to change the value of the parameters shared by two parts, select either part.

#### NOTICE

- In this status, do not press [PLAY] again or any key. Otherwise, recording starts and the data will be deleted.

### 3 Press [REC] again to change the initial settings and to exit from Record Ready mode.

## Transferring SMF Files Between a Computer and this Instrument

With Musicsoft Downloader (available for free downloading), a SMF file can be transferred between the computer and the User Song memory area of this instrument. For details, refer to the “Computer-related Operations” downloadable from Yamaha Manual Library (page 4).

#### NOTICE

- Before you transfer an SMF file from a computer, make sure to transfer the User Song to a computer for safe keeping, since already-recorded data will be replaced with the new transfer.

## Deleting the Entire Song

- 1 Press [REC] to engage Record Ready mode.  
The [REC] lamp will flash.
- 2 While holding down [PLAY], press [REC] so that both the lamps flash.  
To exit from this status, press any other button such as [DEMO/SONG].
- 3 Press [PLAY], [REC], [L] or [R] to delete the data of the entire Song.  
After the operation is completed, both lamps turn off.

## To delete a specific Part:

- 1 While holding down [REC], press [L] or [R] to engage the Record Ready mode.  
The [REC] lamp will flash.
- 2 Press [PLAY] to start recording without playing the keyboard.
- 3 Press [REC] or [PLAY] to stop recording.  
All data recorded for the selected Part will be deleted, and the lamp turns off.

## Song Playback and Practice

All the Songs except for the Demo (page 14) let you turn on or off the [L] and [R] parts individually. By turning off [R], for example, you can practice the [R] part while the [L] part is playing back, and vice versa.

- 1 Start playback of the desired Song.  
To start the User Song, press [PLAY]. To start the Preset Song, press one of the C2 – C#6 keys to start playback while holding down [DEMO/SONG]. For details on what Song number is assigned to each key, see “Quick Operation Guide” (page 22).
- 2 While holding down [PLAY], press [L] or [R] repeatedly to turn the Part on/off.

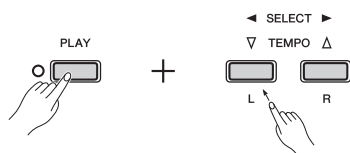

- 3 Practice the part which is turned off.

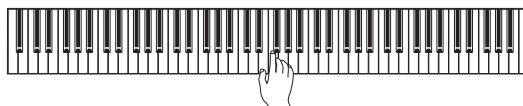

- 4 Press [PLAY] to stop playback.

### NOTE

- Selecting another Song will cancel the on/off status of the parts.

# Backup Data and Initializing

The following data will be maintained as backup data even if you turn off the power.

## Backup data

Metronome/Rhythm Volume, Metronome/Rhythm selection (Beat or Rhythm number), Touch Sensitivity, Tuning, Split Point, Pianist Style Volume, Auto Power OFF, Damper Resonance on/off, I.A.Control on/off, I.A.Control Depth, User Song

## To save the User Song data to a computer:

Among the backup data listed above, only the User Song data can be transferred to a computer and saved as a SMF file. For details, refer to “Computer-related Operations” on the website.

## To initialize the backup data:

While holding down the C7 key (right-most key), turn the power on to initialize the backup data to the factory initial settings.

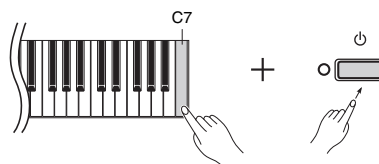

Both the [REC] and [PLAY] lamps flash, indicating that the initialization is being executed. After the operation is completed, both lamps turn off.

### NOTICE

- Never turn off the power while the initialization is being executed.

### NOTE

- If this instrument somehow malfunctions or fails to operate properly, try executing the initialization.

# Auto Power Off Function

To prevent unnecessary power consumption, this function automatically turns the power off if no buttons or keys are operated for approximately 30 minutes. If desired, you can disable or enable this function.

## To disable Auto Power Off:

### When the instrument is turned off:

While holding down the lowest key, press the [ ] (Standby/On) switch to turn on the power so that the power indicator flashes three times, after which the Auto Power Off is disabled.

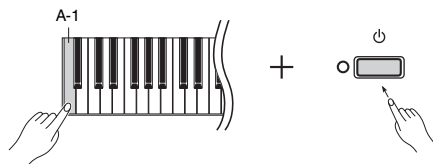

### When the instrument is turned on:

While holding down [DEMO/SONG] and [METRONOME/RHYTHM] simultaneously, press the A-1 key.

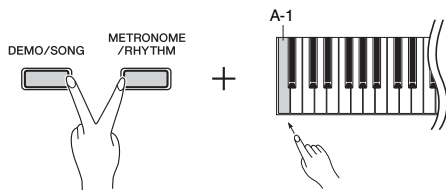

## To enable Auto Power Off:

While holding down [DEMO/SONG] and [METRONOME/RHYTHM] simultaneously, press the A#-1 key.

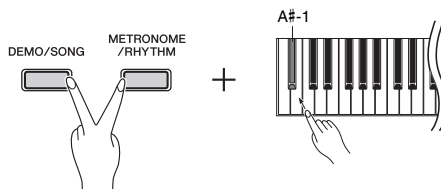

# Troubleshooting

Problem	Possible Cause and Solution
The instrument does not turn on.	The instrument has not been plugged in properly. Securely insert the female plug into the jack on the instrument, and the male plug into a proper AC outlet (page 7).
The instrument is automatically turned off even if no operation is done.	This is normal. This occurs due to the Auto Power Off function (page 19).
Noise is heard from the speakers or headphones.	The noise may be due to interference caused by the use of a mobile phone in close proximity to the instrument. Turn off the mobile phone, or use it further away from the instrument.
The overall volume is low, or no sound is heard.	The Master Volume is set too low; set it to an appropriate level using the [MASTER VOLUME] slider (page 7).
	Make sure a pair of headphones is not connected to the headphones jack (page 7). Make sure that Local Control is ON. For details, refer to "MIDI Reference" (page 4) on the website.
The pedal has no effect.	The pedal cable/plug may not be properly connected. Make sure to securely insert the pedal plug into the [SUSTAIN] or [PEDAL UNIT] jack (page 8).
The footswitch (for sustain) seems to produce the opposite effect. For example, pressing the footswitch cuts off the sound and releasing it sustains the sounds.	The polarity of the footswitch is reversed because the footswitch was pressed when the power was turned on. Turn off the power and turn it on again to reset the function. Make sure to not press the footswitch when turning the power on.

# Specifications

## Dimensions (W x D X H)

- 1,326 x 295 x 163 mm (52-3/16" x 11-5/8" x 6-7/16")

## Weight

- 11.7 kg (25 lbs. 13 oz.)

## Keyboards

- 88 keys (A-1 – C7)
- Graded Hammer Standard (GHS) keyboard
- Touch Sensitivity (Hard/Medium/Soft/Fixed)

## Voice

- 14 Preset Voices
- Polyphony: 128

## Effects/Functions

- 4 Reverb types
- Damper Resonance
- Dual
- Split
- Duo
- Intelligent Acoustic Control

## Pianist Style

- 10 Styles

## Song Playback

- 14 Demo Songs + 50 Preset Songs

## Song Recording

- 1 User Song with 2 tracks
- Data Capacity: One song 100KB (about 11,000 notes)
- Format
  - Playback: SMF (format 0, format 1)
  - Recording: SMF (format 0)

## Overall Functions

- Transpose
- Fine Tuning: 427.0 Hz – 453.0 Hz
- Metronome/10 Rhythms
- Tempo (5 – 280)

## Connectivity

- DC IN (12V), PHONES (2), SUSTAIN, PEDAL UNIT, USB TO HOST, AUX OUT

## Amplifiers

- 7 W + 7 W

## Speakers

- 12 cm x 2 + 5 cm x 2

## Power Supply

- AC Power Adaptor PA-150 or an equivalent recommended by Yamaha

## Power Consumption

- 7W (When using PA-150 power adaptor)

## Included Accessories

- Owner's Manual, Music Rest, AC Power Adaptor PA-150 or an equivalent recommended by Yamaha\*, Online Member Product Registration\*\*, Footswitch
  - \* May not be included depending on your particular area. Please check with your Yamaha dealer.
  - \*\* The PRODUCT ID on the sheet will be needed when you fill out the User Registration form.

## Options

- Keyboard Stand L-85/L-85S/L-85WH, Pedal Unit (LP-5A/LP-5AWH), Foot Pedal FC3, Footswitch FC4/FC5, Headphones (HPE-30/HPE-150), AC Power Adaptor (Users within U.S or Europe: PA-150 or an equivalent recommended by Yamaha, Others: PA-5D, PA-150 or an equivalent)

\* Specifications and descriptions in this owner's manual are for information purposes only. Yamaha Corp. reserves the right to change or modify products or specifications at any time without prior notice. Since specifications, equipment or options may not be the same in every locale, please check with your Yamaha dealer.

# Preset Song List

No.	Title	Composer
1	Invention No. 1	J.S. Bach
2	Invention No. 8	J.S. Bach
3	Gavotte	J.S. Bach
4	Prelude (Wohltemperierte Klavier I No.1)	J.S. Bach
5	Menuett G dur BWV.Anh.114	J.S. Bach
6	Le Coucou	L-C. Daquin
7	Piano Sonate No.15 K.545 1st mov.	W.A. Mozart
8	Turkish March	W.A. Mozart
9	Menuett G dur	W.A. Mozart
10	Little Serenade	J. Haydn
11	Perpetuum mobile	C.M.v. Weber
12	Ecossaise	L.v. Beethoven
13	Für Elise	L.v. Beethoven
14	Marcia alla Turca	L.v. Beethoven
15	Piano Sonate op.13 "Pathétique" 2nd mov.	L.v. Beethoven
16	Piano Sonate op.27-2 "Mondschein" 1st mov.	L.v. Beethoven
17	Piano Sonate op.49-2 1st mov.	L.v. Beethoven
18	Impromptu op.90-2	F.P. Schubert
19	Moments Musicaux op.94-3	F.P. Schubert
20	Frühlingslied op.62-2	J.L.F. Mendelssohn
21	Jägerlied op.19b-3	J.L.F. Mendelssohn
22	Fantaisie-Impromptu	F.F. Chopin
23	Prelude op.28-15 "Raindrop"	F.F. Chopin
24	Etude op.10-5 "Black keys"	F.F. Chopin
25	Etude op.10-3 "Chanson de l'adieu"	F.F. Chopin
26	Etude op.10-12 "Revolutionary"	F.F. Chopin
27	Valse op.64-1 "Petit chien"	F.F. Chopin
28	Valse op.64-2	F.F. Chopin
29	Valse op.69-1 "L'adieu"	F.F. Chopin
30	Nocturne op.9-2	F.F. Chopin
31	Träumerei	R. Schumann
32	Fröhlicher Landmann	R. Schumann
33	La prière d'une Vierge	T. Badarzewska
34	Dolly's Dreaming and Awakening	T. Oesten
35	Arabesque	J.F. Burgmüller
36	Pastorale	J.F. Burgmüller
37	La chevaleresque	J.F. Burgmüller
38	Liebesträume Nr.3	F. Liszt
39	Blumenlied	G. Lange
40	Barcarolle	P.I. Tchaikovsky
41	Melody in F	A. Rubinstein
42	Humoresque	A. Dvořák
43	Tango (España)	I. Albéniz
44	The Entertainer	S. Joplin
45	Maple Leaf Rag	S. Joplin
46	La Fille aux Cheveux de Lin	C.A. Debussy
47	Arabesque 1	C.A. Debussy
48	Clair de lune	C.A. Debussy
49	Rêverie	C.A. Debussy
50	Cakewalk	C.A. Debussy





# Important Notice: Guarantee Information for customers in European Economic Area (EEA) and Switzerland

<b>Important Notice: Guarantee Information for customers in EEA* and Switzerland</b> For detailed guarantee information about this Yamaha product, and Pan-EEA* and Switzerland warranty service, please either visit the website address below. (Printable file is available at our website) or contact the Yamaha representative office for your country. * EEA: European Economic Area	<b>English</b>
<b>Wichtiger Hinweis: Garantie-Information für Kunden in der EWR* und der Schweiz</b> Für nähere Garantie-Information über dieses Produkt von Yamaha, sowie über den Pan-EWR*- und Schweizer Garantieservice, besuchen Sie bitte entweder die folgend angegebene Internetadresse (eine druckfähige Version befindet sich auch auf unserer Webseite), oder wenden Sie sich an den für Ihr Land zuständigen Yamaha-Vertrieb. *EWR: Europäischer Wirtschaftsraum	<b>Deutsch</b>
<b>Remarque importante: informations de garantie pour les clients de l'EEE et la Suisse</b> Pour des informations plus détaillées sur la garantie de ce produit Yamaha et sur le service de garantie applicable dans l'ensemble de l'EEE ainsi qu'en Suisse, consultez notre site Web à l'adresse ci-dessous (le fichier imprimable est disponible sur notre site Web) ou contactez directement Yamaha dans votre pays de résidence. * EEE: Espace Economique Européen	<b>Français</b>
<b>Belangrijke mededeling: Garantie-informatie voor klanten in de EER* en Zwitserland</b> Voor gedetailleerde garantie-informatie over dit Yamaha-product en de garantieservice in heel de EER* en Zwitserland, gaat u naar de onderstaande website (u vindt een afdrukbaar bestand op onze website) of neemt u contact op met de vertegenwoordiging van Yamaha in uw land. * EER: Europese Economische Ruimte	<b>Nederlands</b>
<b>Aviso importante: información sobre la garantía para los clientes del EEE* y Suiza</b> Para una información detallada sobre este producto Yamaha y sobre el soporte de garantía en la zona EEE*, y Suiza, visite la dirección web que se incluye más abajo (la versión del archivo para imprimir está disponible en nuestro sitio web) o póngase en contacto con el representante de Yamaha en su país. * EEE: Espacio Económico Europeo	<b>Español</b>
<b>Aviso importante: informazioni sulla garanzia per i clienti residenti nell'EEA* e in Svizzera</b> Per informazioni dettagliate sulla garanzia relativa a questo prodotto Yamaha e l'assistenza in garanzia nei paesi EEA* e in Svizzera, potete consultare il sito Web all'indirizzo riportato di seguito (è disponibile il file in formato stampabile) oppure contattate l'ufficio di rappresentanza locale della Yamaha. * EEA: Area Economica Europea	<b>Italiano</b>
<b>Aviso importante: informações sobre as garantias para clientes da AEE* e da Suíça</b> Para obter uma informação pormenorizada sobre este produto da Yamaha e sobre o serviço de garantia na AEE* e na Suíça, visite o site a seguir (o arquivo para impressão está disponível no nosso site) ou entre em contato com o escritório de representação da Yamaha no seu país. * AEE: Área Económica Europeia	<b>Português</b>
<b>Σημαντική σημείωση: Πληροφορίες εγγύησης για τους πελάτες στον ΕΟΧ* και Ελβετία</b> Για λεπτομερείς πληροφορίες εγγύησης σχετικά με το παρόν προϊόν της Yamaha και την κάλυψη εγγύησης σε όλες τις χώρες του ΕΟΧ και την Ελβετία, επισκεφτείτε την παρακάτω ιστοσελίδα (Εκτυπώσιμη μορφή είναι διαθέσιμη στην ιστοσελίδα μας) ή απευθυνθείτε στην αντιπροσωπεία της Yamaha στη χώρα σας. * ΕΟΧ: Ευρωπαϊκός Οικονομικός Χώρος	<b>Ελληνικά</b>
<b>Viktigt: Garantierinformation för kunder i EES-området* och Schweiz</b> För detaljerad information om denna Yamaha-produkt samt garantier i hela EES-området* och Schweiz kan du antingen besöka nedanstående webbadress (en utskriftsvärdig fil finns på webbplatsen) eller kontakta Yamahas officiella representant i ditt land. * EES: Europeiska Ekonomiska Samarbetsområdet	<b>Svenska</b>
<b>Viktig merknad: Garantierinformasjon for kunder i EØS* og Sveits</b> Detaljert garantiinformasjon om dette Yamaha-produktet og garantier i hele EØS-området* og Sveits kan fås enten ved å besøke nettsidene nedenfor (utskriftsversjon finnes på våre nettsider) eller kontakte kontaktpunktet i landet der du bor. *EØS: Det europeiske økonomiske samarbeidsområdet	<b>Norsk</b>
<b>Vigtig oplysning: Garantierplysninger til kunder i EØO* og Schweiz</b> De kan finde detaljerede garantierplysninger om dette Yamaha-produkt og de tilhørende garantier i EØO* (og Schweiz) ved at besøge det websted, der er angivet nedenfor (der findes en fil, som kan udskrives, på vores websted), eller ved at kontakte Yamahas nationale repræsentationskontor i det land, hvor De bor. * EØO: Det Europæiske Økonomiske Område	<b>Dansk</b>

<b>Tärkeä ilmoitus: Takuuehdot Euroopan talousaluetta (ETA)* ja Sveitsin asiakkaille</b> Tämän Yamaha-tuotteen sekä ETA-alueen ja Sveitsin takuuta koskevat yksityiskohtaiset tiedot saatte alla olevasta nettiosoitteesta. (Tulostettava tiedosto saatavissa sivustollamme.) Voitte myös ottaa yhteyttä paikalliseen Yamaha-edustajalleen. *ETA: Euroopan talousalue	<b>Suomi</b>
<b>Ważne: Warunki gwarancyjne obowiązujące w EOG* i Szwajcarii</b> Aby dowiedzieć się więcej na temat warunków gwarancyjnych tego produktu firmy Yamaha i serwisu gwarancyjnego w całym EOG* i Szwajcarii, należy odwiedzić wskazaną poniżej stronę internetową (plik gotowy do wydruku znajduje się na naszej stronie internetowej) lub skontaktować się z przedstawicielstwem firmy Yamaha w swoim kraju. * EOG — Europejski Obszar Gospodarczy	<b>Polski</b>
<b>Důležitě oznámení: Záruční informace pro zákazníky v EHS* a ve Švýcarsku</b> Podrobnější informace o tomto produktu Yamaha a záručním servisu v celém EHS* a ve Švýcarsku naleznete na níže uvedené webové adrese (soubor k tisku je dostupný na našich webových stránkách) nebo se můžete obrátit na zastoupení firmy Yamaha ve své zemi. * EHS: Evropský hospodářský prostor	<b>Česky</b>
<b>Fontos figyelemzés: Garancia-információk az EGT* területén és Svájcban élő vásárlók számára</b> A jelen Yamaha termékre vonatkozó részletes garancia-információk, valamint az EGT*-re és Svájcra kiterjedő garanciális szolgáltatás tekintetében keressék fel webhelyünket az alábbi címen (a webhelyen nyomtatható fájl is talál), vagy pedig lépjen kapcsolatba az országában működő Yamaha képviselőirodával. * EGT: Európai Gazdasági Térség	<b>Magyar</b>
<b>Oluline märkus: Garantiteave Euroopa Majanduspiirkonna (EMP)* ja Šveitsi klientidele</b> Täpsema teabe saamiseks selle Yamaha toote garantii ning kogu Euroopa Majanduspiirkonna ja Šveitsi garantiteeninduse kohta, külastage palun veebisaiti alljärgneval aadressil (meie saidil on saadaval printitav fail) või pöörduge Teie riigioni Yamaha esinduse poole. * EMP: Euroopa Majanduspiirkond	<b>Eesti keel</b>
<b>Svartsvars paziņojums: garantijas informācija klientiem EEZ* un Šveicē</b> Lai saņemtu detalizētākas garantijas informāciju par šo Yamaha produktu, kā arī garantijas apkalpošanu EEZ* un Šveicē, lūdzam apmeklēt zemāk norādīto tīmekļa vietnes adresi (tīmekļa vietnē ir pieejams arī lejupielāmes fails) vai sazināties ar Jūsu valstī apliecinājošo Yamaha pārstāvniecību. * EEZ: Eiropas Ekonomikas zona	<b>Latviešu</b>
<b>Dėmesio: informacija dėl garantijos pirkėjams EEE* ir Šveicarijoje</b> Jei reikia išsamesnės informacijos apie šį „Yamaha“ produktą (jo techninę priežiūrą visoje EEE* ir Šveicarijoje, apsilankykite mūsų svetainėje toliau nurodytu adresu (svetainėje yra spausdinamas failas) arba kreipkitės į „Yamaha“ atstovybę savo šalyje. *EEE – Europos ekonominė erdvė	<b>Lietuvių kalba</b>
<b>Dôležité upozornenie: Informácie o záruke pre zákazníkov v EHP* a Švajčiarsku</b> Podrobnejšie informácie o záruke týkajúcej sa tohto produktu od spoločnosti Yamaha a garancijnom servise v EHP* a Švajčiarsku nájdete na webovej stránke uvedenej nižšie (na našej webovej stránke je k dispozícii súbor na tlač) alebo sa obráťte na zástupcu spoločnosti Yamaha vo svojej krajine. * EHP: Európsky hospodársky priestor	<b>Slovenčina</b>
<b>Pomembno obvestilo: Informacije o garanciji za kupce v EGP* in Švici</b> Za podrobnejše informacije o tem Yamaha izdelku ter garancijskem servisu v celotnem EGP in Švici, obiščite spletno mesto, ki je navedeno spodaj (natisljiva datoteka je na voljo na našem spletnem mestu), ali se obrnite na Yamahinega predstavnik v svoji državi. * EGP: Evropski gospodarski prostor	<b>Slovenščina</b>
<b>Важно съобщение: Информация за гаранцията за клиенти в ЕИПТ* и Швейцария</b> За подробна информация за гаранцията за този продукт на Yamaha и гаранционното обслужване в паневропейската зона на ЕИПТ* и Швейцария или посетете посочения по-долу уеб сайт (на нашия уеб сайт има файл за печат), или се свържете с представителния офис на Yamaha във вашата страна. *ЕИПТ: Европейско икономическо пространство	<b>Български език</b>
<b>Notificare importantă: Informații despre garanție pentru clienții din SEE* și Elveția</b> Pentru informații detaliate privind acest produs Yamaha și serviciul de garanție Pan-SEE* și Elveția, vizitați site-ul la adresa de mai jos (fișierul imprimabil este disponibil pe site-ul nostru) sau contactați biroul reprezentanței Yamaha din țara dumneavoastră. * SEE: Spațiul Economic European	<b>Limba română</b>

<http://europe.yamaha.com/warranty/>



MEMO

## Information for Users on Collection and Disposal of Old Equipment



This symbol on the products, packaging, and/or accompanying documents means that used electrical and electronic products should not be mixed with general household waste.

For proper treatment, recovery and recycling of old products, please take them to applicable collection points, in accordance with your national legislation and the Directives 2002/96/EC.

By disposing of these products correctly, you will help to save valuable resources and prevent any potential negative effects on human health and the environment which could otherwise arise from inappropriate waste handling.

For more information about collection and recycling of old products, please contact your local municipality, your waste disposal service or the point of sale where you purchased the items.

### [For business users in the European Union]

If you wish to discard electrical and electronic equipment, please contact your dealer or supplier for further information.

### [Information on Disposal in other Countries outside the European Union]

This symbol is only valid in the European Union. If you wish to discard these items, please contact your local authorities or dealer and ask for the correct method of disposal.

(weee\_eu)

## FCC INFORMATION (U.S.A.)

### 1. IMPORTANT NOTICE: DO NOT MODIFY THIS UNIT!

This product, when installed as indicated in the instructions contained in this manual, meets FCC requirements. Modifications not expressly approved by Yamaha may void your authority, granted by the FCC, to use the product.

### 2. IMPORTANT:

When connecting this product to accessories and/or another product use only high quality shielded cables. Cable/s supplied with this product MUST be used. Follow all installation instructions. Failure to follow instructions could void your FCC authorization to use this product in the USA.

### 3. NOTE:

This product has been tested and found to comply with the requirements listed in FCC Regulations, Part 15 for Class "B" digital devices. Compliance with these requirements provides a reasonable level of assurance that your use of this product in a residential environment will not result in harmful interference with other electronic devices. This equipment generates/uses radio frequencies and, if not installed and used according to the instructions found in the users manual, may cause interference harmful to the operation of other electronic devices. Compliance with FCC regulations does

not guarantee that interference will not occur in all installations. If this product is found to be the source of interference, which can be determined by turning the unit "OFF" and "ON", please try to eliminate the problem by using one of the following measures:

Relocate either this product or the device that is being affected by the interference.

Utilize power outlets that are on different branch (circuit breaker or fuse) circuits or install AC line filter/s.

In the case of radio or TV interference, relocate/reorient the antenna. If the antenna lead-in is 300 ohm ribbon lead, change the lead-in to co-axial type cable.

If these corrective measures do not produce satisfactory results, please contact the local retailer authorized to distribute this type of product. If you can not locate the appropriate retailer, please contact Yamaha Corporation of America, Electronic Service Division, 6600 Orangethorpe Ave, Buena Park, CA90620

The above statements apply ONLY to those products distributed by Yamaha Corporation of America or its subsidiaries.

\* This applies only to products distributed by YAMAHA CORPORATION OF AMERICA.

(class B)

### OBSERVERA!

Apparaten kopplas inte ur växelströmskällan (nätet) så länge som den är ansluten till vägguttaget, även om själva apparaten har stängts av.

**ADVARSEL:** Netspændingen til dette apparat er IKKE afbrudt, så længe netledningen sidder i en stikkontakt, som er tændt — også selvom der er slukket på apparatets afbryder.

**VAROITUS:** Laitteen toisiopiiriin kytketty käyttökötkin ei irroita koko laitetta verkosta.

(standby)

The model number, serial number, power requirements, etc., may be found on or near the name plate, which is at the bottom of the unit. You should note this serial number in the space provided below and retain this manual as a permanent record of your purchase to aid identification in the event of theft.

**Model No.**

---

**Serial No.**

---

(bottom\_en\_01)

### COMPLIANCE INFORMATION STATEMENT (DECLARATION OF CONFORMITY PROCEDURE)

Responsible Party : Yamaha Corporation of America  
Address : 6600 Orangethorpe Ave., Buena Park,  
Calif. 90620  
Telephone : 714-522-9011  
Type of Equipment : Digital Piano  
Model Name : P-105

This device complies with Part 15 of the FCC Rules.

Operation is subject to the following two conditions:

- 1) this device may not cause harmful interference, and
- 2) this device must accept any interference received including interference that may cause undesired operation.

See user manual instructions if interference to radio reception is suspected.

\* This applies only to products distributed by  
YAMAHA CORPORATION OF AMERICA.

(FCC DoC)

For details of products, please contact your nearest Yamaha representative or the authorized distributor listed below.

Pour plus de détails sur les produits, veuillez-vous adresser à Yamaha ou au distributeur le plus proche de vous figurant dans la liste suivante.

Die Einzelheiten zu Produkten sind bei Ihrer unten aufgeführten Niederlassung und bei Yamaha Vertragshändlern in den jeweiligen Bestimmungsländern erhältlich.

Para detalles sobre productos, contacte su tienda Yamaha más cercana o el distribuidor autorizado que se lista debajo.

## NORTH AMERICA

### CANADA

**Yamaha Canada Music Ltd.**  
135 Milner Avenue, Scarborough, Ontario,  
M1S 3R1, Canada  
Tel: 416-298-1311

### U.S.A.

**Yamaha Corporation of America**  
6600 Orangethorpe Ave., Buena Park, Calif. 90620,  
U.S.A.  
Tel: 714-522-9011

## CENTRAL & SOUTH AMERICA

### MEXICO

**Yamaha de México S.A. de C.V.**  
Calz. Javier Rojo Gómez #1149,  
Col. Guadalupe del Moral  
C.P. 09300, México, D.F., México  
Tel: 55-5804-0600

### BRAZIL

**Yamaha Musical do Brasil Ltda.**  
Rua Joaquim Floriano, 913 - 4º andar, Itaim Bibi,  
CEP 04534-013 Sao Paulo, SP. BRAZIL  
Tel: 011-3704-1377

### ARGENTINA

**Yamaha Music Latin America, S.A.**  
**Sucursal de Argentina**  
Olga Cossetini 1553, Piso 4 Norte  
Madero Este-C1107CEK  
Buenos Aires, Argentina  
Tel: 011-4119-7000

### PANAMA AND OTHER LATIN AMERICAN COUNTRIES/ CARIBBEAN COUNTRIES

**Yamaha Music Latin America, S.A.**  
Torre Banco General, Piso 7, Urbanización Marbella,  
Calle 47 y Aquilino de la Guardia,  
Ciudad de Panamá, Panamá  
Tel: +507-269-5311

## EUROPE

### THE UNITED KINGDOM/IRELAND

**Yamaha Music Europe GmbH (UK)**  
Sherbourne Drive, Tilbrook, Milton Keynes,  
MK7 8BL, England  
Tel: 01908-366700

### GERMANY

**Yamaha Music Europe GmbH**  
Siemensstraße 22-34, 25462 Rellingen, Germany  
Tel: 04101-3030

### SWITZERLAND/LIECHTENSTEIN

**Yamaha Music Europe GmbH**  
**Branch Switzerland in Zürich**  
Seefeldstrasse 94, 8008 Zürich, Switzerland  
Tel: 044-387-8080

### AUSTRIA

**Yamaha Music Europe GmbH Branch Austria**  
Schleiergasse 20, A-1100 Wien, Austria  
Tel: 01-60203900

### CZECH REPUBLIC/HUNGARY/ ROMANIA/SLOVAKIA/SLOVENIA

**Yamaha Music Europe GmbH**  
**Branch Austria (Central Eastern Europe Office)**  
Schleiergasse 20, A-1100 Wien, Austria  
Tel: 01-602039025

### POLAND/LITHUANIA/LATVIA/ESTONIA

**Yamaha Music Europe GmbH**  
**Branch Poland Office**  
ul. Wrotkowa 14 02-553 Warsaw, Poland  
Tel: 022-500-2925

### BULGARIA

**Dinacord Bulgaria LTD.**  
Bul. Iskarsko Schose 7 Targowski Zentar Ewropa  
1528 Sofia, Bulgaria  
Tel: 02-978-20-25

### MALTA

**Olimpus Music Ltd.**  
The Emporium, Level 3, St. Louis Street Msida  
MSD06  
Tel: 02133-2144

### THE NETHERLANDS/ BELGIUM/LUXEMBOURG

**Yamaha Music Europe Branch Benelux**  
Clarissenhof 5-b, 4133 AB Vianen, The Netherlands  
Tel: 0347-358 040

### FRANCE

**Yamaha Music Europe**  
7 rue Ambroise Croizat, Zone d'activités Pariest,  
77183 Croissy-Beaubourg, France  
Tel: 01-64-61-4000

### ITALY

**Yamaha Music Europe GmbH, Branch Italy**  
Viale Italia 88, 20020 Lainate (Milano), Italy  
Tel: 02-935-771

### SPAIN/PORTUGAL

**Yamaha Music Europe GmbH Ibérica, Sucursal en España**  
Ctra. de la Coruna km. 17, 200, 28230  
Las Rozas (Madrid), Spain  
Tel: 91-639-8888

### GREECE

**Philippos Nakas S.A. The Music House**  
147 Skiathou Street, 112-55 Athens, Greece  
Tel: 01-228 2160

### SWEDEN

**Yamaha Music Europe GmbH Germany filial Scandinavia**  
J. A. Wettergrens Gata 1, Box 30053  
S-400 43 Göteborg, Sweden  
Tel: 031 89 34 00

### DENMARK

**Yamaha Music Europe GmbH, Tyskland - filial Denmark**  
Generatorvej 6A, DK-2730 Herlev, Denmark  
Tel: 44 92 49 00

### FINLAND

**F-Musiikki Oy**  
Kluuvikatu 6, P.O. Box 260,  
SF-00101 Helsinki, Finland  
Tel: 09 618511

### NORWAY

**Yamaha Music Europe GmbH Germany - Norwegian Branch**  
Grini Næringspark 1, N-1345 Østerås, Norway  
Tel: 67 16 77 70

### ICELAND

**Skifan HF**  
Skeifan 17 P.O. Box 8120, IS-128 Reykjavik, Iceland  
Tel: 525 5000

### RUSSIA

**Yamaha Music (Russia)**  
Room 37, bld. 7, Kievskaya street, Moscow,  
121059, Russia  
Tel: 495 626 5005

### OTHER EUROPEAN COUNTRIES

**Yamaha Music Europe GmbH**  
Siemensstraße 22-34, 25462 Rellingen, Germany  
Tel: +49-4101-3030

## AFRICA

**Yamaha Corporation,**  
**Asia-Pacific Sales & Marketing Group**  
Nakazawa-cho 10-1, Naka-ku, Hamamatsu,  
Japan 430-8650  
Tel: +81-53-460-2313

## MIDDLE EAST

### TURKEY/CYPRUS

**Yamaha Music Europe GmbH**  
Siemensstraße 22-34, 25462 Rellingen, Germany  
Tel: 04101-3030

### OTHER COUNTRIES

**Yamaha Music Gulf FZE**  
LOB 16-513, P.O.Box 17328, Jubel Ali,  
Dubai, United Arab Emirates  
Tel: +971-4-881-5868

## ASIA

### THE PEOPLE'S REPUBLIC OF CHINA

**Yamaha Music & Electronics (China) Co.,Ltd.**  
2F, Yunhedasha, 1818 Xinzha-lu, Jingan-qu,  
Shanghai, China  
Tel: 021-6247-2211

### HONG KONG

**Tom Lee Music Co., Ltd.**  
11/F., Silvercord Tower 1, 30 Canton Road,  
Tsimshatsui, Kowloon, Hong Kong  
Tel: 2737-7688

### INDIA

**Yamaha Music India Pvt. Ltd.**  
Spazedge building, Ground Floor, Tower A, Sector  
47, Gurgaon- Sohna Road, Gurgaon, Haryana, India  
Tel: 0124-485-3300

### INDONESIA

**PT. Yamaha Musik Indonesia (Distributor)**  
**PT. Nusantik**  
Gedung Yamaha Music Center, Jalan Jend. Gatot  
Subroto Kav. 4, Jakarta 12930, Indonesia  
Tel: 021-520-2577

### KOREA

**Yamaha Music Korea Ltd.**  
8F, 9F, Dongsung Bldg. 158-9 Samsung-Dong,  
Kangnam-Gu, Seoul, Korea  
Tel: 02-3467-3300

### MALAYSIA

**Yamaha Music (Malaysia) Sdn., Bhd.**  
Lot 8, Jalan Perbandaran, 47301 Kelana Jaya,  
Petaling Jaya, Selangor, Malaysia  
Tel: 03-78030900

### PHILIPPINES

**Yupangco Music Corporation**  
339 Gil J. Puyat Avenue, P.O. Box 885 MCPO,  
Makati, Metro Manila, Philippines  
Tel: 819-7551

### SINGAPORE

**Yamaha Music (Asia) PRIVATE LIMITED**  
Blk 202 Hougang Street 21, #02-00,  
Singapore 530202, Singapore  
Tel: 6747-4374

### TAIWAN

**Yamaha KHS Music Co., Ltd.**  
3F, #6, Sec.2, Nan Jing E. Rd. Taipei.  
Taiwan 104, R.O.C.  
Tel: 02-2511-8688

### THAILAND

**Siam Music Yamaha Co., Ltd.**  
4, 6, 15 and 16th floor, Siam Motors Building,  
891/1 Rama 1 Road, Wangmai,  
Pathumwan, Bangkok 10330, Thailand  
Tel: 02-215-2622

### OTHER ASIAN COUNTRIES

**Yamaha Corporation,**  
**Asia-Pacific Sales & Marketing Group**  
Nakazawa-cho 10-1, Naka-ku, Hamamatsu,  
Japan 430-8650  
Tel: +81-53-460-2313

## OCEANIA

### AUSTRALIA

**Yamaha Music Australia Pty. Ltd.**  
Level 1, 99 Queensbridge Street, Southbank,  
Victoria 3006, Australia  
Tel: 3-9693-5111

### NEW ZEALAND

**Music Works LTD**  
P.O.BOX 6246 Wellesley, Auckland 4680,  
New Zealand  
Tel: 9-634-0099

### COUNTRIES AND TRUST TERRITORIES IN PACIFIC OCEAN

**Yamaha Corporation,**  
**Asia-Pacific Sales & Marketing Group**  
Nakazawa-cho 10-1, Naka-ku, Hamamatsu,  
Japan 430-8650  
Tel: +81-53-460-2313



Yamaha Global Site  
<http://www.yamaha.com/>

Yamaha Manual Library  
<http://www.yamaha.co.jp/manual/>

U.R.G., Digital Musical Instruments Division  
© 2012 Yamaha Corporation

205POTY\*-\*-01A0  
Printed in China

ZA70840