

# ARC 2

Advanced Room Correction System

## User Manual



Measurement  
Microphone



Correction Plug-In



Measurement  
Software

ARC System 2 is powered by



IK Multimedia. Musicians First.





## PLEASE NOTE

ARC System™ is a trademark property of IK Multimedia Production Srl. Audyssey®, Audyssey MultEQ® XT 32 are registered trademarks property of Audyssey Laboratories™ Inc. used under license. All other product names and images, trademarks and artists names are the property of their respective owners, which are in no way associated or affiliated with IK Multimedia. Use of these names does not imply any cooperation or endorsement.

# ARC System 2

# ARC System 2

## Table of Contents

<b>I</b>	<b>Contents</b>	pag. 3
<b>II</b>	<b>License Agreement</b>	pag. 6
<b>III</b>	<b>What's New in ARC System 2</b>	pag. 8
<b>Chapter 1</b>	<b>ARC System 2 Overview</b>	pag. 9
1.1	Introduction	pag. 9
1.2	What is the ARC System 2?	pag. 10
1.3	How does the ARC System 2 work?	pag. 12
<b>Chapter 2</b>	<b>The ARC System 2 components</b>	pag. 15
2.1	The ARC 2 Measurement Microphone	pag. 15
2.2	The ARC 2 Measurement Software	pag. 15
2.3	The ARC 2 Correction Plug-In	pag. 16
<b>Chapter 3</b>	<b>Setup for measurements</b>	pag. 17
3.1	What you need to measure your room	pag. 17
3.1.1	Audio Interface Requirements	pag. 17
3.2	How to set up for measurements	pag. 17
3.2.1	Speaker connection	pag. 17
3.2.2	Powered Speaker setup	pag. 18
3.2.3	Passive Speaker setup	pag. 19
3.2.4	Active Subwoofer and Powered Speakers setup	pag. 20
3.2.5	How to connect the ARC 2 Measurement Microphone	pag. 21
<b>Chapter 4</b>	<b>Using the ARC 2 Measurement</b>	pag. 23
4.1	Opening the ARC 2 Measurement software	pag. 23
4.2	Welcome to the ARC System 2	pag. 23
4.3	STEP 1 - Microphone Selection	pag. 24
4.4	STEP 2 - Set up your Audio I/O	pag. 25
4.5	STEP 3 - Put the Microphone at the main position and adjust levels	pag. 26
4.5.1	Microphone orientation	pag. 27
4.5.2	Microphone height	pag. 28
4.6	STEP 4 - Take measurements	pag. 30
4.6.1	Examples of measurement locations in various room types	pag. 31
4.6.2	Take Measurements	pag. 36
4.7	STEP 5 - Save your system correction	pag. 38
<b>Chapter 5</b>	<b>Using the ARC 2 Plug-In</b>	pag. 39
5.1	ARC 2 Plug-In interface	pag. 39
5.1.1	Play Window	pag. 39
5.1.2	Measurement menu	pag. 40
5.1.3	Target Curve menu	pag. 41
5.1.4	Virtual Monitoring Feature	pag. 43
5.1.5	Frequency Response Graphs	pag. 43
5.1.6	Speaker Icons	pag. 44

# ARC System 2

5.1.7	Peak Meter	pag. 44
5.1.8	Correction ON switch and TRIM knob	pag. 44
5.1.9	Other controls	pag. 45
5.2	Edit Window	pag. 46
5.2.1	EQ points	pag. 46
5.2.2	Custom 1-4 buttons	pag. 47
5.2.3	Apply button	pag. 47
5.2.4	Flat button	pag. 47
5.2.5	Combined L/R Correction	pag. 47
5.2.6	Full Range Bass Correction	pag. 48
5.3	Monitor Control Window	pag. 50
5.3.1	Main volume knob	pag. 50
5.3.2	Dim switch	pag. 50
5.3.3	Mute switch	pag. 50
5.3.4	Mode selector	pag. 51
5.3.5	MIDI Assign of Remote Controls	pag. 51
5.4	Opening the ARC 2 Plug-In in your DAW	pag. 51
5.5	Using the ARC 2 Plug-In	pag. 52
5.6	Suggestions for the best ARC System 2 usage	pag. 53
<b>Chapter 6</b>	<b>Frequently Asked Questions</b>	pag. 55
<b>Chapter 7</b>	<b>Troubleshooting</b>	pag. 59
<b>Chapter 8</b>	<b>Support</b>	pag. 63
8.1	User Area	pag. 63

# ARC System 2

# ARC System 2

## License Agreement

### END-USER LICENSE AGREEMENT FOR IK MULTIMEDIA PRODUCT

Please read this document carefully before breaking the seal on the media package. This agreement licenses the enclosed software to you and contains warranty and liability disclaimers.

By breaking the seal on the media envelope, you are confirming to have taken notice of terms and conditions of this agreement and you acknowledge your acceptance of the software as well as your acceptance of the terms of this agreement. If you do not wish to do so, do not break the seal. Instead, promptly return the entire package, including the unopened media package, to the dealer from whom you have obtained it, for a full refund.

#### 1) DEFINITIONS

“EULA” means this end user license agreement

“IK Multimedia Product” means the software program included in the enclosed package, and all related updates supplied by IK Multimedia.

“IK Multimedia Product” means the software program and hardware (if any) included in the enclosed package, the related documentation, models, multimedia content (such as animation, sound and graphics) and all related updates supplied by IK Multimedia.

“Not for resale (NFR) Version” means a version of IK Multimedia Product, so identified, is intended for review and evaluation purposes, only.

#### 2) LICENSE

The “IK Multimedia Product” is protected by copyright laws and international copyright treaties, as well as other intellectual property laws and treaties. The “IK Multimedia Product” is licensed, not sold. This EULA grants you the rights as specified here below. All other actions and means of usage are reserved to the written permission of the right holder IK Multimedia Production Srl:

**Applications Software.** The “IK Multimedia Product” may be used only by you. You may install and use the “IK Multimedia Product”, or any prior version thereof for the same operating system, on up to three (3) computers, provided that (a) each computer is owned by (or leased to) and under the exclusive control of the licensee; (b) the program(s) shall NOT be used simultaneously on more than one machine, and (c) any computer(s) with IK Multimedia software installed shall not be sold, rented, leased, loaned or otherwise be removed from the licensee’s possession without first removing (uninstalling) the licensed software, except as provided in Paragraph 4 (below) pertaining to “Software Transfer”.

**Storage/Network use.** You may also store or install a copy of the “IK Multimedia Product” on a storage device, such as a network server, used only to install or run the “IK Multimedia Product” on your other computers over an internal network; however, you must acquire and dedicate a distinct license for each user of the “IK Multimedia Product” from the storage device. Any given license for the “IK Multimedia Product” may not be shared or used concurrently or otherwise on different computers or by different developers in a given organization.

#### 3) AUTHORIZATION CODE

The “IK Multimedia Product” only functions when you have authorized it. The “IK Multimedia Product” will be authorized upon completing the authorization procedure. Once your product is authorized, you may use it.

You agree to follow the authorization procedure and will provide true, accurate and complete information about yourself. If you provide any information that is untrue, inaccurate, not correct or incomplete, or IK Multimedia has reasonable grounds to suspect that such information is untrue, inaccurate, not correct or incomplete, IK Multimedia has the right to suspend or to revoke the license.

The termination of the license shall be without prejudice to any rights, whatsoever, of IK Multimedia.

#### 4) DESCRIPTION OF OTHER RIGHTS AND LIMITATIONS

**Limitations on Reverse Engineering, Decompilation, and Disassembly.** You may not reverse engineer, decompile, or disassemble the “IK Multimedia Product”, except and only to the extent that such activity is expressly permitted by applicable law notwithstanding this limitation of components. The “IK Multimedia Product” is licensed as a single product. Its component parts may not be separated for use on more than one computer.

**Not for Resale Version.** If the “IK Multimedia Product” is labeled “Not for Resale” or “NFR” or “Evaluation Copy”, then, notwithstanding other sections of this EULA, you may not sell, or otherwise transfer the “IK Multimedia Product”.

**Rental.** You may not rent, lease, or lend the “IK Multimedia Product” to any party.

**Software Transfer.** You may not transfer, license or sublicense your rights as Licensee of the software or any IK Multimedia product, as licensed to you under this agreement without prior written consent of the rights owner. The carrier on which the IK Multimedia product has been distributed may be transferred or otherwise made available to any third party only with the prior written consent of the rights owner and provided that (a) the original media



and license(s) accompany the carrier and (b) the party transferring the media does not retain a copy of the media.

## 5) UPGRADES

If the "IK Multimedia Product" is labeled or otherwise identified by IK Multimedia as an "upgrade", you must be properly licensed to use a product identified by IK Multimedia as being eligible for the upgrade in order to use the "IK Multimedia Product".

An "IK Multimedia Product" labeled or otherwise identified by IK Multimedia as an upgrade replaces and/or supplements the product that formed the basis for your eligibility for such upgrade. You may use the resulting upgraded product only in accordance with the terms of this EULA. If the "IK Multimedia Product" is an upgrade of a component of a package of software programs that you licensed as a single product, the "IK Multimedia Product" may be used and transferred only as part of that single product package and may not be separated for use on more than one computer.

## 6) DUAL-MEDIA SOFTWARE

You may receive the "IK Multimedia Product" in more than one medium. You may not loan, rent, lease, or otherwise transfer the other medium to another user, except as part of the permanent transfer (as provided above) of the "IK Multimedia Product".

## 7) LIMITED WARRANTY

IK Multimedia warrants to the original purchaser of the computer software product, for a period of ninety (90) days following the date of original purchase, that under normal use, the software program and the user documentation are free from defects that will materially interfere with the operation of the program as described in the enclosed user documentation.

## 8) WARRANTY CLAIMS

To make a warranty claim under the above limited warranty, please return the product to the point of purchase, accompanied by proof of purchase, your name, your return address and a statement of the defect, or send the CD(s) to us at the below address within ninety (90) days of purchase. Include a copy of the dated purchase receipt, your name, your return address and a statement of the defect. IK Multimedia or its authorized dealer will use reasonable commercial efforts to repair or replace the product and return it to you (postage prepaid) or issue to you a credit equal to the purchase price, at its option.

## 9) LIMITATIONS ON WARRANTY

IK Multimedia warrants only that the program will perform as described in the user documentation. No other advertising, description or representation, whether made by a IK Multimedia dealer, distributor, agent or employee, shall be binding upon IK Multimedia or shall change the terms of this warranty.

**EXCEPT AS STATED ABOVE, IK MULTIMEDIA MAKES NO OTHER WARRANTY, EXPRESSED OR IMPLIED, REGARDING THIS PRODUCT. IK MULTIMEDIA DISCLAIMS ANY WARRANTY THAT THE SOFTWARE IS FIT FOR A PARTICULAR PURPOSE, AND ANY IMPLIED WARRANTY OF MERCHANTABILITY SHALL BE LIMITED TO A NINETY (90) DAY DURATION OF THIS LIMITED EXPRESS WARRANTY AND IS OTHERWISE EXPRESSLY AND SPECIFICALLY DISCLAIMED. IK MULTIMEDIA SHALL NOT BE LIABLE FOR SPECIAL, INCIDENTAL, CONSEQUENTIAL OR OTHER DAMAGES, EVEN IF IK MULTIMEDIA IS ADVISED OF OR AWARE OF THE POSSIBILITY OF SUCH DAMAGES. THIS MEANS THAT IK MULTIMEDIA PRODUCTION SRL SHALL NOT BE RESPONSIBLE OR LIABLE FOR THE LOSS OF PROFITS OR REVENUES, OR FOR DAMAGES OR COSTS AS A RESULT OF LOSS OF TIME, DATA OR USE OF THE SOFTWARE, OR FROM ANY OTHER CAUSE EXCEPT THE ACTUAL COST OF THE PRODUCT. IN NO EVENT SHALL IK MULTIMEDIA LIABILITY EXCEED THE PURCHASE PRICE OF THIS PRODUCT.**

## 10) CHOICE OF LAW

You agree that any and all claims, suits or other disputes arising from your use of the software shall be determined in accordance with the laws of Italy, in the event IK Multimedia, is made a party thereto. You agree to submit to the jurisdiction of the court in Modena, Italy for all actions, whether in contract or in tort, arising from your use or purchase of the software.

## 11) GENERAL

This Agreement contains the complete agreement between the parties with respect to the subject matter hereof, and supersedes all prior or contemporaneous agreements or understandings, whether oral or written. All questions concerning this Agreement shall be directed to:

IK Multimedia Production Srl  
Via dell'Industria 46  
41122 Modena  
Italy

© 2007-2012 IK Multimedia. All rights reserved.

# ARC System 2

## What's New in ARC System 2

- Redesigned Graphic User Interface.
- 4X greater resolution powered by Audyssey MultEQ® XT32 room correction technology with 10Hz resolution.
- Less measurements needed for optimum results.
- Improved, precise bass response and focus.
- Smoother midrange and high frequency response.
- Combined L/R Correction option.
- Customizable EQ curves.
- “Virtual Monitoring” feature.
- MIDI remote controllable Monitoring section.
- 64 bit native support.
- Up to 192KHz sample rate support.
- Legacy measurement files support (down to ARC 1.3).

## Chapter 1 ARC System 2 Overview

### 1.1 Introduction

The popularity of Digital Audio Workstation (DAW)-based systems have made them the most used recording and mixing solution for hundreds of thousands of professional, project and home studios worldwide. While much emphasis is placed on the gear and tools used for composing, mixing and mastering, one of the most critical factors influencing the quality of a music production is the accuracy of the monitoring system. In fact, the combination of speakers and room acoustics are often the weakest link in the music production chain.

Nearfield monitor systems used in studio environments are designed to deliver sound without distortion or coloration. However, when monitors are placed in a room, surrounding walls, ceiling, furniture, and other objects reflect and absorb their sounds, creating complex distortions specific to the room and causing them to lose the accuracy for which they have been designed. In other words, you end up hearing more of the sound of the room than the actual music being produced.

The traditional solutions to this problem so far have been acoustic treatments, traditional room correction EQ, or lately, advanced self-calibrated monitor systems. Unfortunately, each of these options has some drawbacks which may not be the best alternative for today's DAW-based music production scenarios.

Acoustic treatments require a degree of expertise in their set-up that is not commonly available among musicians working in project and home studios. At the same time, it can be extremely expensive for professional studios, especially when a precise sonic target result is required and the room is not optimally shaped. A complete and successful acoustical treatment usually means a hefty price tag for many, making it an option only for a few high-end studios.

Traditional room correction EQ and advanced self-calibrated monitor systems are also expensive, and generally they are only able to correct the frequency response of a room but not the phase problems that can be introduced by room acoustics. On the contrary, traditional room correction EQ will alter the phase response by itself, adding this to the already present phase room alterations. All these phase distortions summed up is one of the reasons that leads many engineers to turn off equalizers on the monitoring setup after briefly trying them. Moreover, traditional correction EQ calibrates the response by only considering one single position in the room (called the "sweet spot"), usually making the listening experience in other zones of the room even worse. Lastly, all of these systems fail when it comes to easy portability and mobile situations which is now the growing trend for laptop-based mobile studios and traveling musicians.

To offer the definitive solution for DAW-based studios, IK Multimedia has teamed up with Audyssey Laboratories™ Inc., the leading provider of sound equalization solutions, for the production of an innovative, low-cost, mobile solution to correct the distortion problems caused by room acoustics: The ARC System.

# ARC System 2

## 1.2 What is the ARC System 2?

The Advanced Room Correction (ARC) System 2 includes 3 components:

1. **ARC 2 Measurement Microphone**
2. **ARC 2 Measurement Software**
3. **ARC 2 Plug-In**

The ARC System 2 is a combination of a professional calibrated measurement microphone (figure 1.1), measuring software (figure 1.2), and a multi-platform plug-in (figure 1.3) – that can be integrated with any DAW-based studio – capable of correcting the distortion caused by room acoustics and able to improve how a studio will sound forever.



figure 1.1



figure 1.2



figure 1.3

# ARC System 2

ARC System 2 features Audyssey MultEQ® XT32 room correction technology which measures sound information throughout your listening area in various zones of the room and then combines this information to create an accurate equalization solution for the room's acoustical problems. The equalization solution then corrects both time and frequency response problems more effectively and efficiently than any other room correction EQ on the market.

The ARC System 2 represents one of the most advanced solutions to acoustic problems for any DAW-based studio, and it dramatically improves the acoustics of home and project studios as well as correcting even the most thorough acoustically treated high-end studio. The ARC System 2 produces results like you have never heard before to improve the accuracy of your monitoring system. When you experience the ARC System 2, the perspective of what you are recording, mixing or mastering becomes immediately clear and reliable.

The audible results are:

- Low-end alterations (typically added by small rooms) are removed with better low frequency control.
- More consistent frequency response across the entire range.
- Tonal balance is restored which lets you create more accurate mixes.

And the following advantages are achieved:

- Room defects will no longer divert your attention, and you can focus solely on the music while also reducing ear fatigue.
- You can mix faster and better, because now you are sure about what you are hearing.
- Achieve greater consistency on your music productions.
- Create mixes that translate to the outside world without problems.

Moreover, if you are a traveling musician, you can conveniently bring the ARC System 2 with you and quickly measure/correct any studio or room so you can produce music in any environment to maximize your time and fuel your creative power.

# ARC System 2

## 1.3 How does the ARC System 2 work?

### 1) The first step is to measure your room.

To measure your room, just connect the ARC 2 Measurement Microphone to any phantom powered MIC input in your audio interface, and launch the ARC 2 Measurement software (figure 1.4) from your Mac or PC computer. Then, ARC 2 Measurement will guide you through 5 easy steps to properly set up the microphone and measure your room. Thanks to the Audyssey MultEQ® XT32 room correction technology, the ARC System 2 not only allows you to measure and correct the sweet spot (usually where the mixing engineer is seated), but also to measure multiple positions in the room to ensure the most accurate representation of its acoustical problems in the overall space.



figure 1.4

In fact, instead of applying a standard EQ as all other systems do (that will be helpful only in the sweet spot and make all other room areas sound worse than before), the ARC System 2 will analyze all your studio zones such as your center sweet spot, producer desk or client couch. Then it will provide a correction curve that effectively works for all of the zones at the same time. Once the measurement sets have been taken, the ARC 2 Measurement software will save its results as a file that describes the room acoustics and its relative correction. If you have various speaker configurations, just repeat the process by taking multiple measurement sets and saving them in different files. The overall measurement process will take only a few minutes, but the ARC System 2 will give you a timeless solution.

# ARC System 2

2) The second step is to apply the correction as a plug-in in your preferred DAW.

Open your DAW (such as Pro Tools®, Cubase®, Logic®, Sonar®, Live™, Digital Performer™, etc.), and insert the ARC 2 Plug-In (figure 1.5) on the stereo master bus, load the measurement file you just saved from the measurement menu, turn the correction on, and voilà, the alterations introduced by your room acoustics will be corrected. This will allow you to finally trust the sound of your studio monitors and room.



figure 1.5

This particular screen-shot of the ARC 2 Plug-In (figure 1.6) shows how a highly distorted monitoring system is flattened almost perfectly when MultEQ® XT32 is applied.



figure 1.6

Orange shows the actual room response, green shows the flat-response of an ideal speakers/room system, and white shows the corrected room

# ARC System 2

response applied by the ARC 2 system. As you can see, the low frequency extension of the speaker is not pushed beyond the physical limits of the speaker which is another advantage in comparison to all conventional room correction EQs (“auto” equalizers).



## Chapter 2 The ARC System 2 components

### 2.1 The ARC 2 Measurement Microphone

The ARC 2 Measurement Microphone provides an overall higher quality when compared to low or mid-priced measurement microphones. Measurement microphones usually exhibit a flat frequency response at the expense of poor sensitivity and a noise level that is too high for quality recording.

The ARC 2 Measurement Microphone exhibits a flat frequency response, and at the same time, its sensitivity, noise level and max SPL are extremely good. This means that you will be able to use this mic not only to measure your room but also to record various acoustic sources.

In addition, this microphone is omni-directional. This makes the proximity effect found in typical studio cardioid microphones disappear and instead sounding very open and natural. This aspect makes it even more useful when you consider that in entry-level studios, omni-directional microphones are usually not an option.

Technical Specifications:

- Type: 1/4" precision measurement condenser microphone.
- Polar pattern: omnidirectional, free field.
- Capsule frequency response: 20-16,000 Hz.
- Calibrated frequency response when used with ARC 2: 16-20,000 Hz, +/- 1.5 dB.
- Output: transformerless, electronically balanced, 200 ohms output impedance.
- Sensitivity: 50 mV/Pa.
- Noise Equivalent Level: 22 dB.
- Max SPL: 130 dB for 3% THD.

### 2.2 The ARC 2 Measurement Software

The ARC 2 Measurement software is a standalone application that analyzes your speakers and room system and automatically calculates the best possible correction that will be applied later by the ARC 2 Plug-In.

The ARC 2 Measurement software works by sending test tones to your speakers and at the same time recording the signal captured in the room by the ARC 2 Measurement Microphone.

# ARC System 2

## 2.3 The ARC 2 Correction Plug-In

This multi-platform plug-in is the ARC System 2 component that will apply the ARC System 2 correction curve measured by the ARC 2 Measurement software to the monitoring system.

The ARC 2 Plug-In should be inserted on your DAW's stereo master bus or, when possible, on the monitoring bus.

## Chapter 3 Setup for measurements

### 3.1 What you need to measure your room

To correctly measure your room, you need:

- The ARC 2 Measurement software properly installed. This is included in the ARC System 2 installer and works as a standalone application.
- A high-quality audio interface with at least one XLR microphone input with +48V phantom power.
- The ARC 2 Measurement Microphone.
- Microphone stand and XLR microphone cable.

#### 3.1.1 Audio Interface Requirements

To correctly measure your room, you need a high-quality audio interface that can operate at 48 kHz and can reliably record one channel while playing back two channels (full duplex operation must be supported).

The ARC 2 Measurement software only supports ASIO drivers on Windows and CoreAudio drivers on Macintosh. Please check that your audio interface supports these standard drivers.

**IMPORTANT NOTE:** considering that the measurement process must be done at 48 kHz, the ARC 2 Measurement software must set your audio interface sampling rate at 48 kHz. For this reason, please check that your audio interface sampling rate is not locked and that 48 kHz is supported and allowed.

The ARC 2 Measurement will try to set the sampling rate to 48 kHz as soon you select your audio interface. If the audio interface cannot be set to 48 kHz, an alert message will inform you that the room measurements cannot be taken.

### 3.2 How to set up for measurements

To properly measure your room, you need to connect the ARC 2 Measurement Microphone to your audio interface and your audio interface to the speakers. Usually you will already have the speakers properly connected, so you do not need to change anything on the speaker connections at all. What is important is having a pair of outputs of from audio interface going to the speakers with as direct a path as possible.

#### 3.2.1 Speaker connection

Make sure that your Left (L) and Right (R) speakers are connected directly to a pair of your audio interface outputs. If anything is present between your audio

# ARC System 2

interface and your speakers (like a mixer, a monitor management system, etc), please check that their settings do not alter the audio signal in any way (e.g., no tone controls, no mono switch, phase reverse, etc).

If you use a powered subwoofer that performs bass management, just connect your audio interface outputs to the subwoofer inputs, and your L and R satellites to the proper subwoofer outputs. This way, the system will still be seen as a standard dual channel system (with an increased low frequency extension).

## 3.2.2 Powered Speaker setup

Figure 3.1 shows one possible way to connect your system components when powered speakers are used.

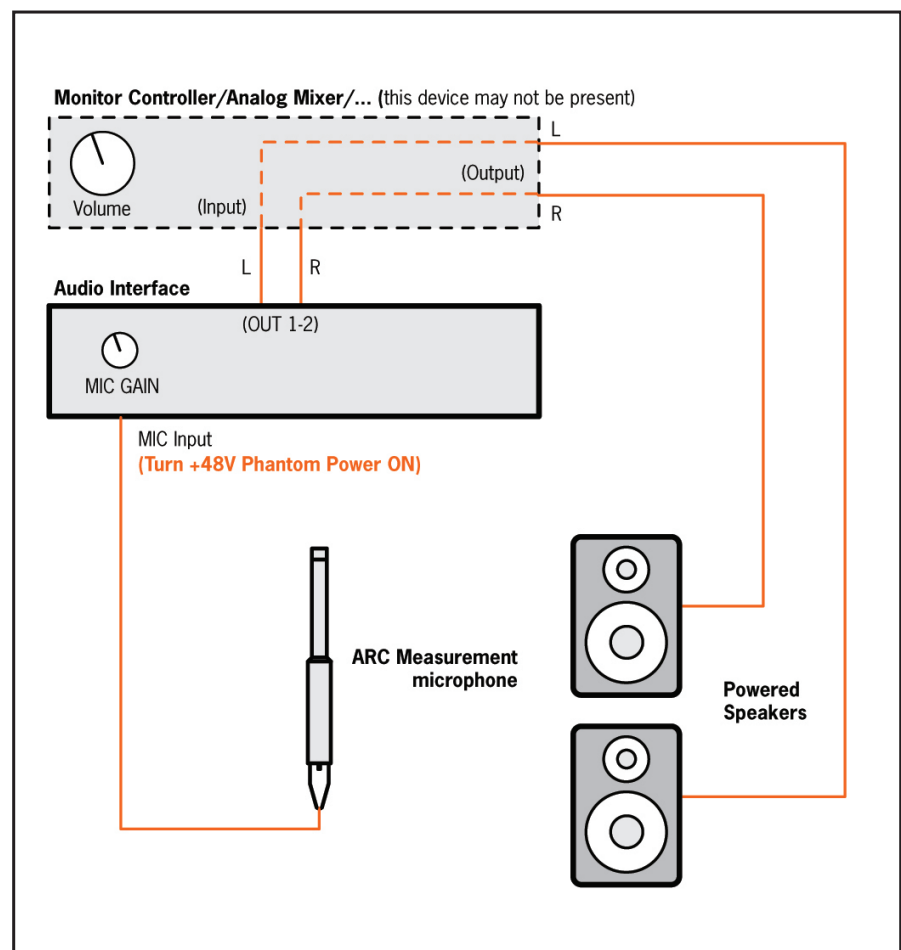

figure 3.1

# ARC System 2

## 3.2.3 Passive Speaker setup

Figure 3.2 shows one possible way to connect your system components when passive speakers are used.

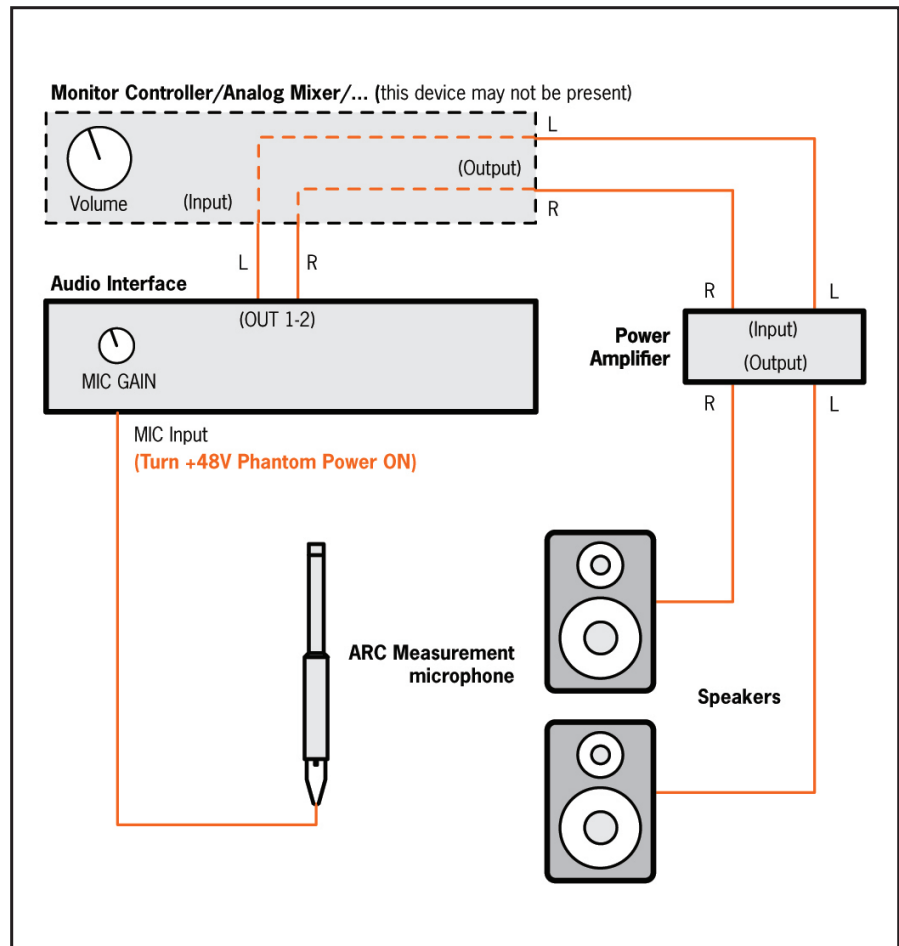

figure 3.2

# ARC System 2

## 3.2.4 Active Subwoofer and Powered Speakers setup

Figure 3.3 shows one possible way to connect your system components when an active subwoofer is used together with powered speakers.

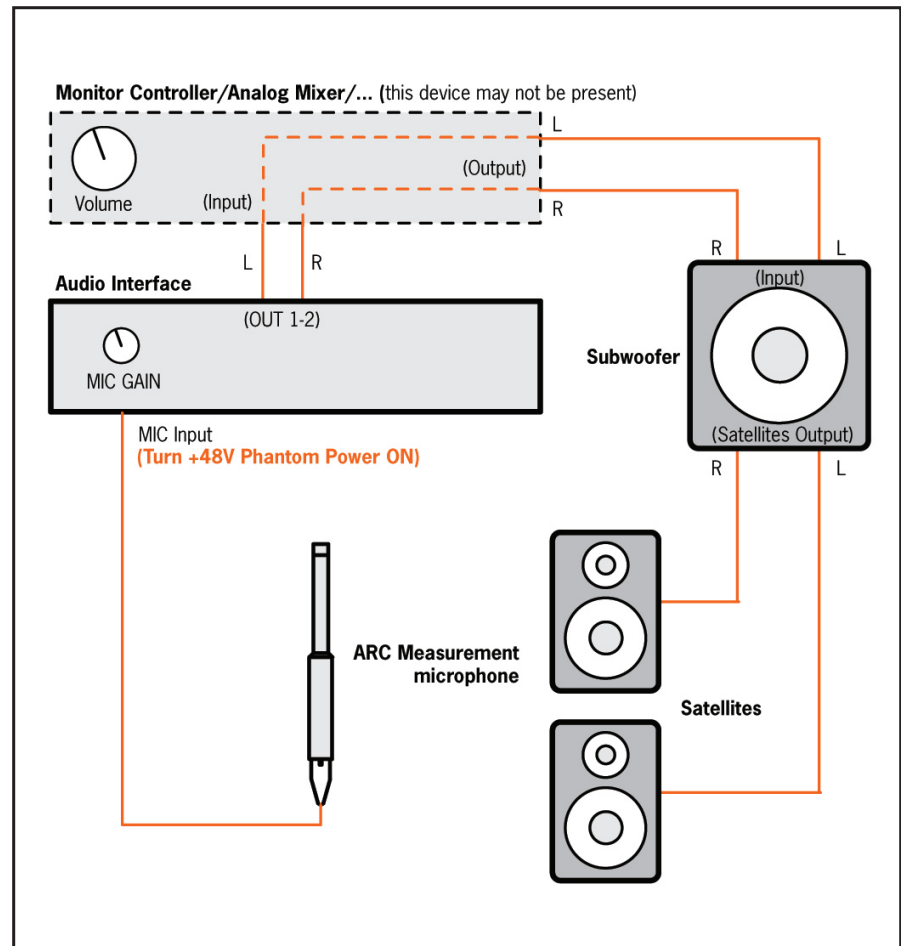

figure 3.3

# ARC System 2

## 3.2.5 How to connect the ARC 2 Measurement Microphone

Please connect the ARC 2 Measurement Microphone to a high-quality microphone preamplifier, and enable the +48V phantom power supply.

Please check these two options (both are okay):

- a. The preamplifier is built into the audio interface. In this case, the microphone will be directly connected to the XLR input on the audio interface without using any attenuator pad and with +48V phantom power turned on.
- b. The audio interface has no mic preamplifier. In this case, you will need to connect the microphone to an external preamplifier or to a mixer, and then connect the preamplifier output to the audio interface line input.

To get the necessary precision, the preamplifier should be as clean and flat as possible. For this reason, you should avoid using tube preamplifiers for measuring. Also, electronically balanced (transformerless) preamplifiers are preferred over transformer-based designs which tend to color the sound too much.

To start, set the gain control on your preamplifier to its middle position. Probably you will have to adjust this later on when setting levels.

### **IMPORTANT: TURN DIRECT MONITORING OFF.**

Any direct monitoring on the audio interface mixer should be turned OFF. To confirm this, simply check that no microphone signal at all is going out to the speakers.

# ARC System 2



## Chapter 4 Using the ARC 2 Measurement

### 4.1 Opening the ARC 2 Measurement software

On Windows, go to your Start Menu \ Programs and launch ARC 2 Measurement.

On Macintosh, go to your Applications folder, and launch ARC 2 Measurement.

### 4.2 Welcome to the ARC System 2

Upon launching the Measurement app, ARC 2 will display its welcome screen. Click NEXT to continue (figure 4.1).



figure 4.1

Note: after you have completed each step's instructions, click NEXT. The step number will be displayed in the top left area as STEP 2 of 5, and the steps indicator will show you the steps already made (1) and the current step (2).

# ARC System 2

## 4.3 STEP 1 - Microphone Selection

The ARC 2 Measurement Microphone is available in two slightly different versions. It is important to keep in mind that neither microphone is inherently better or worse; It is simply that due to a small difference in frequency response the software must be told which microphone you are using to ensure the most accurate measurement possible.

To determine which microphone type you're using, simply check the P/N number on the label of your microphone, and then select the corresponding option on the ARC 2 Measurement application (figure 4.2). This number is located above the XLR connector on your microphone. You can also determine which microphone type you have by checking to see if your microphone has an orange ring around the microphone located near the XLR connector.



figure 4.2

Once you have selected which microphone type you have, click NEXT to proceed with the ARC 2 Measurement process. If you have not selected a microphone type, you will not be able to click NEXT to continue.

**IMPORTANT:** if the wrong microphone type is selected, the resulting ARC 2 correction will be incorrect. Please take the time to make sure that you have selected the correct microphone to ensure an accurate measurement!

# ARC System 2

## 4.4 STEP 2 - Set up your Audio I/O

Select your audio hardware here, and choose which channels to use for speaker outputs and the microphone input (figure 4.3).



figure 4.3

**Audio Hardware:** click this menu to select the audio interface you are using for the measurement process. ASIO-compatible interfaces will be listed in Windows, and CoreAudio-compatible interfaces will be listed in Mac OS X.

**OUTPUT L:** click this menu to select the audio interface output that is connected to the LEFT speaker, for example, “Output 1.”

**OUTPUT R:** click this menu to select the audio interface output that is connected to the RIGHT speaker, for example, “Output 2.”

**Microphone INPUT:** click this menu to select the audio interface input where the ARC 2 Measurement Microphone is connected. Remember to set the Gain at the middle position now, and turn on +48V phantom power supply).

**ASIO Panel:** this button only appears in Windows where ASIO drivers are used.

**IMPORTANT NOTE:** considering that the measurement process must be done at 48 kHz, the ARC 2 Measurement software must set your audio interface sampling rate at 48 kHz. For this reason, please check your audio interface that the sampling rate is not locked and that 48 kHz is supported and allowed.

ARC 2 Measurement will try to set the sampling rate to 48 kHz as soon you select your audio interface. If the audio interface cannot be set at 48 kHz, an alert message will notify you that the room measurements cannot be taken.

Click NEXT once the Interface, Outputs and Microphone Input are all correctly selected.

# ARC System 2

## 4.5 STEP 3 - Put the Measurement Microphone at the main position and adjust levels

Step 3 will tell you to how to check levels and properly measure the room (figure 4.4).



figure 4.4

The Levels adjustment must be done with the ARC 2 Measurement Microphone positioned at the main listening position. Therefore, the first thing you need to do is to place the ARC 2 Measurement Microphone at the main listening position. From now on in this user manual, we will refer to the “main position” as the single listening position where you usually sit when listening to your monitors. On figure 4.5, the number “1” identifies the main position.

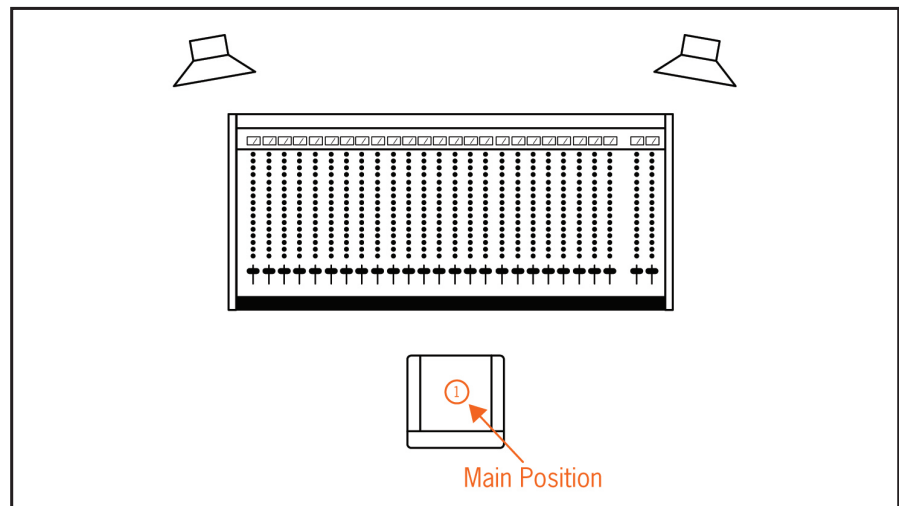

figure 4.5

The Main position identification is important but not critical. You can con-

# ARC System 2

sider the main position as a point in the middle of the speakers at a distance where you usually sit when working on your mixes.

## 4.5.1 Microphone orientation

The ARC 2 Measurement Microphone must be positioned VERTICALLY for all ARC 2 measurements (figure 4.6).

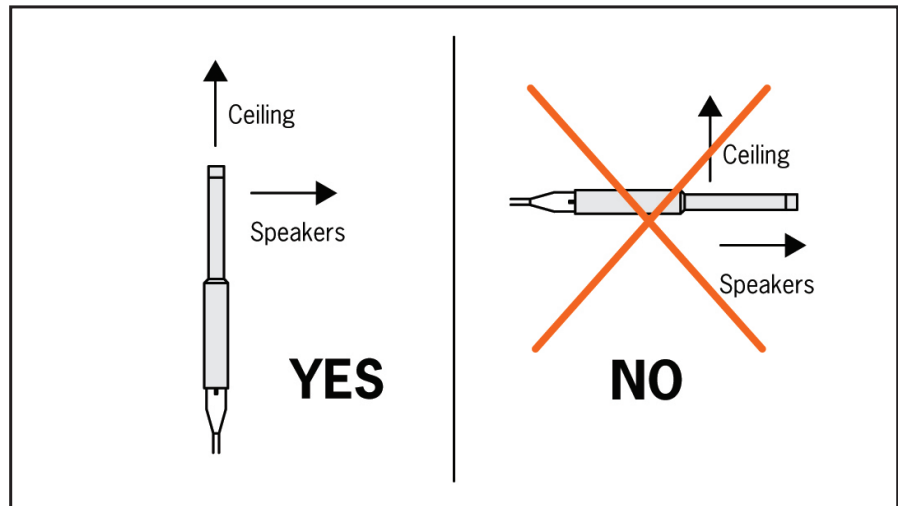

figure 4.6

Do not attempt to measure the room by pointing the microphone at the speakers, because all measurements will be wrong, and the resulting correction will be wrong as well.

After securely clipping the microphone on a standard mic stand, be sure to point it at the ceiling. Ideally, the microphone should be perfectly perpendicular to the floor.

Try to use a mic stand with a boom arm that is extended as far away from the stand as possible. This helps avoid reflections from the stand that will interfere with the measurements at high frequencies. Do not stand or sit near the microphone while the measurements are running.

# ARC System 2

## 4.5.2 Microphone height

Set the microphone to the same height where your ears are when listening to the speakers (figure 4.7).

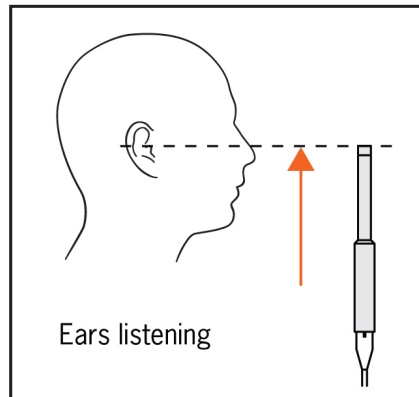

figure 4.7

At this point, you should have your ARC 2 Measurement Microphone connected to the audio interface mic input (+48 V phantom power ON), pointed at the ceiling, and at the correct height.

Now place the microphone at the main position (figure 4.8).

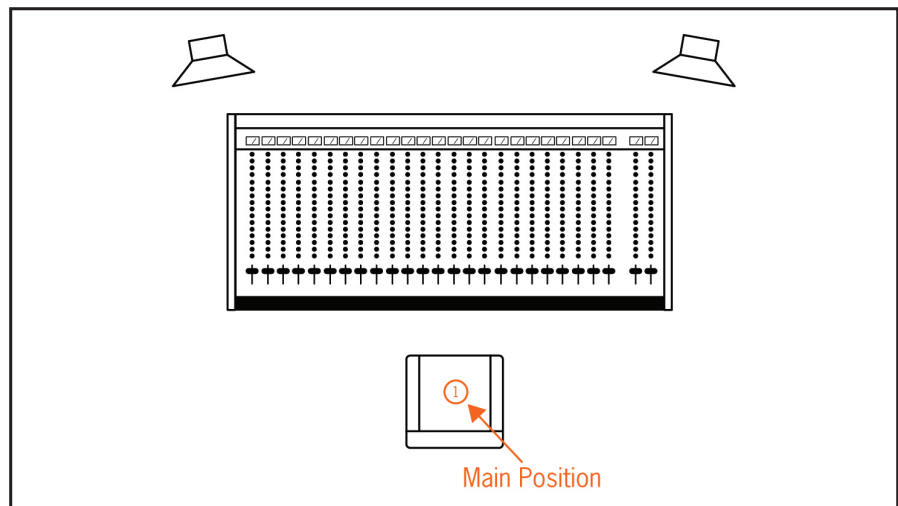

figure 4.8

Once the microphone is correctly positioned at the main position, you can start checking levels.

1. Lower your studio listening volume to ZERO. The studio listening volume can be controlled on your audio interface with the main outputs level control or with your monitoring management system.

# ARC System 2



figure 4.9



figure 4.10

If you are using a mixer, you can use your “control room” level.

2. Click PLAY TEST (figure 4.9). This will generate a test sound (chirp), and it will be sent to the outputs specified in point 4.4.
3. Now SLOWLY increase your studio listening level. You should start hearing the test tone playing back continuously. Stop increasing the listening volume at the point where the test tone is at a medium intensity, more or less at the level you are working at in your studio. **CAUTION! DO NOT INCREASE THE LISTENING LEVEL TOO FAST.** This could create damage to your speakers and to your hearing if the monitoring system is very powerful.
4. Check the Input Level Meter indicator in the ARC 2 Measurement software (figure 4.10). This meter shows the level of the signal captured by the ARC 2 Measurement Microphone.
  - a. While the test tone is playing (and leaving the Microphone Level slider in its default position), slowly adjust the MIC GAIN control on your audio interface (or on your microphone preamplifier) to have the Input Level Meter indicator display within the “OK” range.
  - b. In case you have increased the MIC GAIN control on your interface to maximum and still see a very low signal or no signal at all on the peak meter, please check that all cabling and connections are okay, and turn Phantom Power on.
  - c. If you need to finely adjust the level shown on the Input Level Meter, just use the Microphone Level slider on the ARC 2 Measurement Software.
  - d. Always check that your audio interface preamplifier is NOT clipping. If you are not sure about which MIC GAIN control setting is best (for example, in case you have two settings that deliver a signal within the okay range) always use the lowest one. You can always trim it by using the ARC 2 Measuring software Microphone Level slider.
5. Once you set the correct level, click PLAY TEST again to stop the test tone generator.
6. DO NOT CHANGE any of the audio settings (studio listening level, MIC GAIN control, etc.), and click NEXT.

# ARC System 2

## 4.6 STEP 4 - Take measurements

During Step 4, you will take all the necessary measurements to properly analyze the room (figure 4.11).



figure 4.11

**IMPORTANT NOTE:** unlike most other room correction systems, ARC 2 needs from 7 to 16 measurement positions.

A minimum of 7 measurement positions is required. It is not possible to proceed with the measurement wizard until they are properly taken.

Each measurement should be taken at a different point in the room to cover the entire area in which you plan to sit when listening to your speakers. A single or a few points measurement will never be accurate, and this cannot precisely represent the real acoustical problems of the room. Consequently, the ARC System 2 requires at least 7 measurements for two main reasons:

1. The ARC System 2 can fix the acoustics of a room from various listening areas at the same time. To do that, it needs to measure each listening area.
2. Even if you are planning to listen in a small area, the ARC System 2 requires at least 7 measurements to properly analyze different listening points, even if they are separated a few inches from each other.

After clicking TAKE MEASUREMNT, this button will change to CANCEL. To stop a making a measurement, press CANCEL.



# ARC System 2

## 4.6.1 Examples of measurement locations in various room types

This section will visually describe a number of different audio production rooms with an indication of where the measurement microphone should be placed for each measurement. However, these diagrams should only be used as examples and not as specific positional instructions for your own room.

The order of each of the 7 required measurements is not critical. However, it is essential to take the measurements in a symmetrical pattern. Using a clock quadrant as an example, if you take a measurement at 9 o'clock, then you need to take another measurement at 3 o'clock, and so on. Now if you have two listening areas, a chair plus a "client couch" like in example 3, the result will be more accurate if you take one measurement set (with 7 required measurements or more) per listening area. Please check the following examples below:

### Example 1

Studio, one chair, one main listening position (figure 4.12).

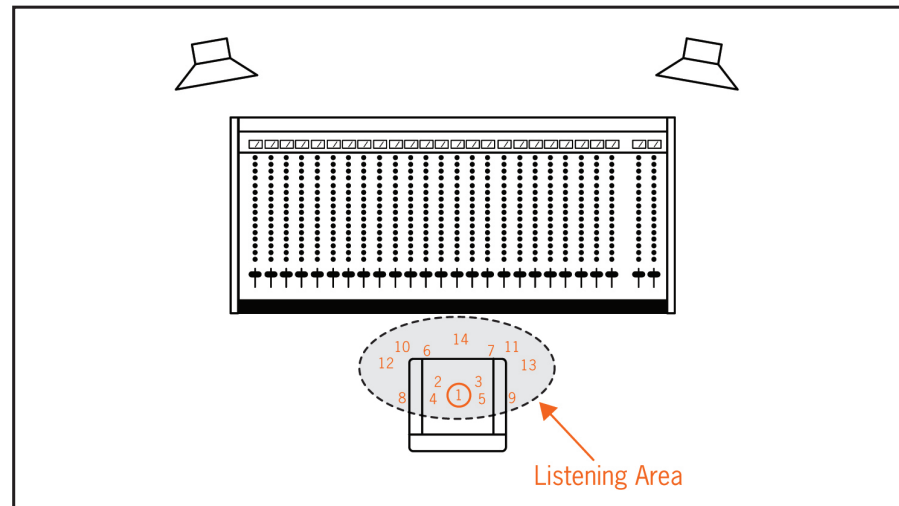

figure 4.12

Main position is marked as 1, and it is perfectly centered between the two speakers at the main listening position. This is the position you should use to calibrate levels (see Paragraph 4.5) and for the first measurement.

All other measurements are symmetrical to an imaginary central line, so measurements after the first one (main position) are taken alternatively on the Left and Right side.

# ARC System 2

## Example 2

Studio, two chairs, wider listening position (figure 4.13).

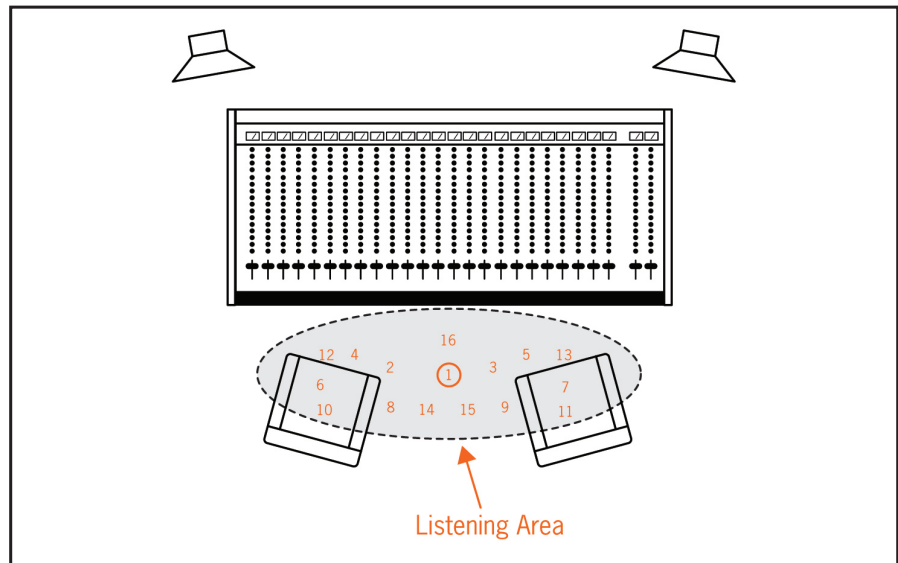

figure 4.13

Main position is marked as 1, and it is perfectly centered between the two speakers at the listening position. This is the position you should use to calibrate levels and for the first measurement.

All other measurements are symmetrical to an imaginary central line, so measurements after the initial one (main position) are taken alternatively on the Left and Right side.

The optimized listening area is wider than the one shown in figure 4.13, so the measured points location are distributed in a way that covers the entire listening area.

# ARC System 2

## Example 3

Studio, one chair plus “client couch” listening area (figure 4.14).

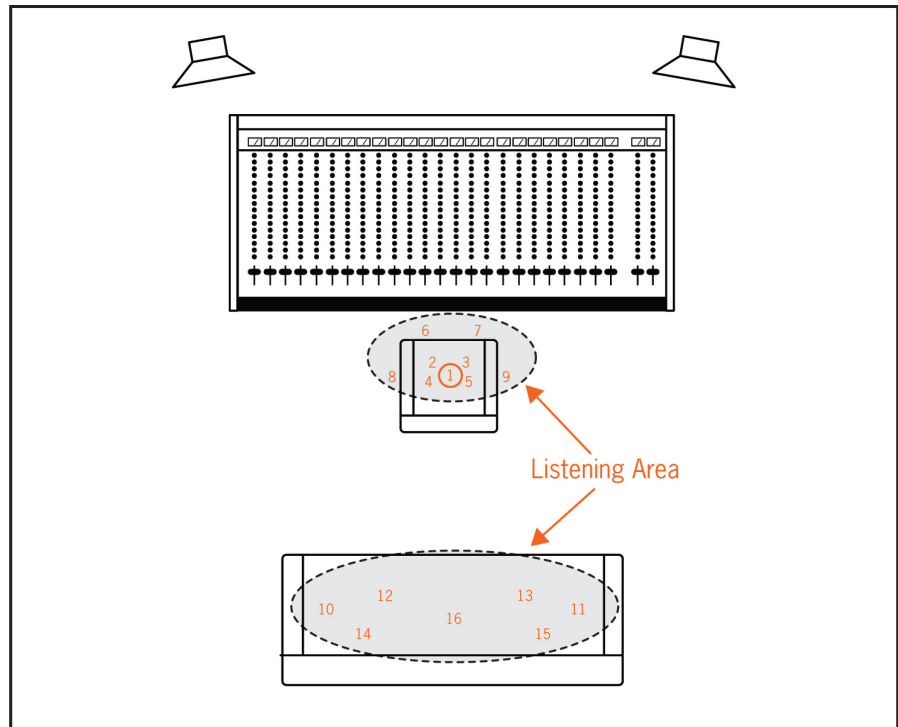

figure 4.14

Main position is marked as 1, and it is perfectly centered between the two speakers at the main listening position. This is the position you should use to calibrate levels and for the first measurement.

All other measurements are symmetrical to an imaginary central line, so measurements after the first one (Main position) are taken alternatively on the Left and Right side.

The optimized listening area is extended to the client couch as well; Placing the microphone as shown on figure 4.14 will create a correction intervention that optimizes the listening at the engineer’s chair and at the client couch at the same time.

In a situation like this, we suggest saving two measurements sets (or corrections), so that one set can be done with all 16 measurements at the engineer’s chair, and the other set will include the client couch. The most suitable correction will be loaded in the ARC 2 Plug-In depending on whether the client is present and wants to listen from the couch.

# ARC System 2

## Example 4

Movie mixing studio/theater (figure 4.15).

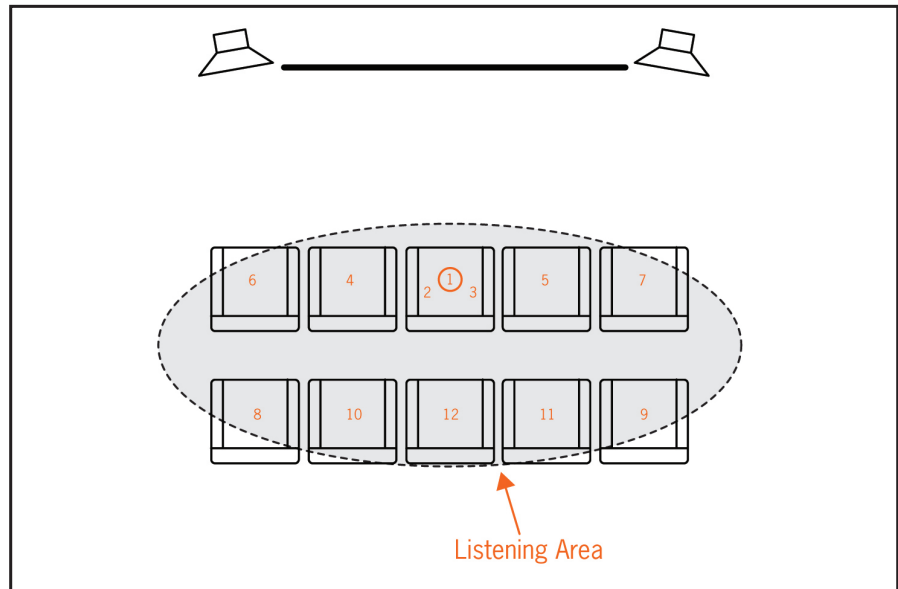

figure 4.15

Main position is marked as 1, and it is perfectly centered between the two speakers at the main listening position. This is the position you should use to calibrate levels and for the first measurement.

All other measurements are symmetrical to an imaginary central line, so measurements after the initial one (Main position) are taken alternatively on the Left and Right side.

The entire sitting area is covered, and the most “accurate” listening experience will be at the main chair, front line.

# ARC System 2

## Example 5

Project studio (figure 4.16).

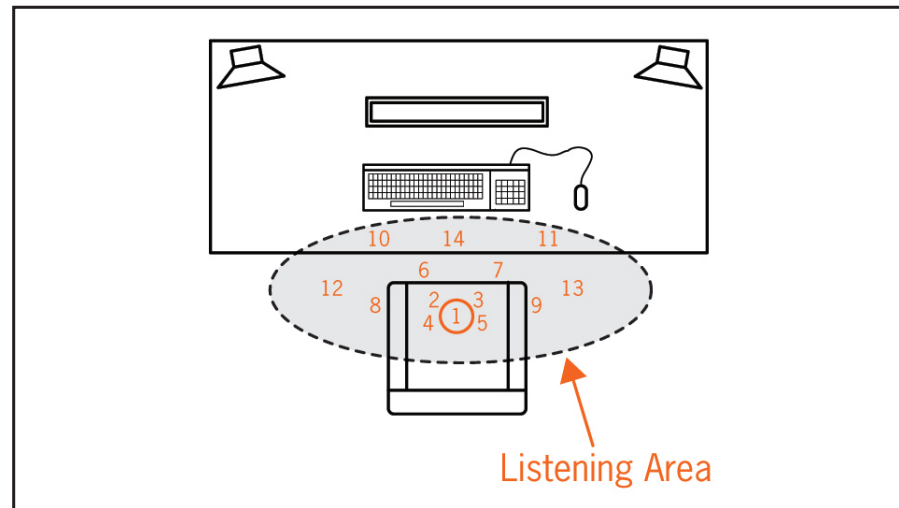

figure 4.16

Main position is marked as 1 and it is perfectly centered between the two speakers at the main listening position. This is the position you should use to calibrate levels and for the 1st measurement.

All other measurements are symmetrical to an imaginary central line, so measurements after the first one (Main position) are taken alternatively on the Left and Right side.

A minimum of 7 measurements is needed but, as shown in figure 4.16, we suggest to take at least 11-16 measurements.

Please note that these are just examples. Since all rooms are different, you should experiment with various measuring patterns and take several measurement sets to maximize the ARC System 2 capabilities and expand your monitoring options. Then you can store all measurement sets and recall them later in the ARC 2 Plug-In allowing for direct on-the-fly comparisons.

It should be noted that the quality of the correction curve is only as good as the accuracy and care taken when doing measurements. Since the measurement process is supposed to be done only once, we strongly suggest giving this process the importance it deserves.

See the next paragraph for a step-by-step description of how to take all measurements.

# ARC System 2

## 4.6.2 Take Measurements



figure 4.17

Follow these simple steps to properly measure the room.

Preparing to measure:

1. DO NOT CHANGE ANY OF THE LEVELS THAT HAVE BEEN SET AT POINT 4.5.
2. Quiet the room as much as possible (e.g., if you are using a fan and/or air conditioning, please turn it off while measuring your room).
3. Be sure that the room doors or windows are set as they will be during your usual listening. For example, don't close the main door when measuring if this door is never closed while you are working or vice-versa.
4. If you usually work with a few people at each the session, try to measure the room in the same conditions.

Taking the measurements:

1. Place the ARC 2 Measurement Microphone at the main position.
2. Click TAKE MEASUREMENT. Do not make any noise during the measurement process.
3. A measurement chirp will be played 10 times on the left speaker and 10 times on the right speaker for each measurement.
4. Do not walk, talk or move while the chirps are playing or during pauses between the chirps.
5. Do not touch the microphone until the ARC 2 Measurement display says "Move the microphone to the next position, then click TAKE MEASUREMENT" and the arrow has moved to the next measurement number.
6. When a measurement has been successfully taken, its number is

# ARC System 2

highlighted, and the arrow moves to the next one (figure 4.18). This picture shows measurement #1 successfully taken, and the ARC 2 Measurement System stands by to take measurement #2.



figure 4.18

7. Repeat points 2, 3, 4, 5 and 6 for all measurements. (figure 4.19)



figure 4.19

8. Note that you will not be able to press NEXT until 7 successful measurements are taken.
9. If possible, always take more than the required 7 measurements. We recommend taking 11 to 16 measurements.
10. Once you are done with the measurements, click NEXT.

# ARC System 2

## 4.7 STEP 5 - Save your system correction

Once all measurements have been taken, you will be presented with this screen. (figure 4.20).



figure 4.20

**Measurement name:** click this field, and then name the recently taken measurement set. You can measure several speaker sets or various listening conditions (see paragraph 4.6.1 - Examples of measurement locations in various room types), and give different names to each of them. This feature is very useful because you will be able to instantly recall different measurement sets in the ARC 2 Plug-In to match the needed monitoring requirements.

**Speaker icon:** after naming your measurement set (and before pressing the FINISH button), you can choose your preferred speaker icon. This is just a mnemonic aid to easily recall and associate your speakers with a particular measurement set. It does not affect the sound in any way.



## Chapter 5 Using the ARC 2 Plug-In

### 5.1 ARC 2 Plug-In interface

ARC 2 Plug-In is a multiplatform audio processor that applies the correction curve measured with the ARC 2 Measurement software to the incoming audio stereo signal in real-time. It is comprised of three operation windows each one dedicated to specific tasks.

#### 5.1.1 Play Window

This window (figure 5.1) is where you can see how ARC 2 is performing the correction on your monitoring:



figure 5.1

The ARC 2 Plug-In applies one of the measurement sets you have saved from the ARC 2 Measurement software on your stereo master bus to match several different target curves. You are able to switch from one measurement set to another allowing you to compare your saved options and meet your different sonic needs.

It will also show graphical frequency responses for the left and right channels both before and after the correction.

The ARC 2 Plug-In alters the stereo master bus level. For this reason, a precision peak meter is included to show both input or output levels (pre/post) so that the actual project master level can still be kept under control.

# ARC System 2

## 5.1.2 Measurement menu

Click this menu (figure 5.2) to select the measurement set you saved from the ARC 2 measurement system.



figure 5.2

ARC 2 is backward compatible with measurement files taken and used with previous ARC System versions (ARC 1.3 minimum) and they will be listed in the measurement menu below new ones; however, due to the different and improved structure of the MultEQ® XT32 algorithm which powers the correction, several features of ARC 2 will be unavailable when these older measurement files will be loaded; this will be shown by the name of the measurement highlighted in a red color once selected (fig. 5.3).



figure 5.3

# ARC System 2

The unavailable features are:

- Correction Cures are limited to the standard four Audyssey® factory target.
- Custom EQ drag functions will be disabled.
- Legacy Measures won't be available when ARC 2 is used in sessions where sample rate is beyond 96KHz as previous versions of ARC System could not go past that sample rate.
- Combined L/R correction.
- Improved resolution.

We strongly suggest you take the time to properly measure your room again so that you will be able to fully take advantage of the four times improved resolution of the new MultEQ® XT32 plug in architecture and all of the new ARC 2 amazing features.

## 5.1.3 Target Curve menu

To cover a wide range of room types, the ARC 2 provides a selection of four Factory Target Curves created by Audyssey plus a set of 4 custom, user definable curves. Click this menu (figure 5.4) to select one of these eight Target Curves:



figure 5.4

- AUDYSSEY FLAT
- AUDYSSEY HF Roll-off 1
- AUDYSSEY FLAT (Mid Comp)
- AUDYSSEY HF Roll-off 1 (Mid Comp)
- Custom 1
- Custom 2
- Custom 3
- Custom 4

# ARC System 2

**AUDYSSEY FLAT:** the system will correct the frequency response so that the final response will be very close to flat. However, the system will not extend the low frequency response of the speakers beyond their limits to avoid possible damage and excessive distortion. In fact, the AUDYSSEY Flat curve corrects the response to flat from the low frequency cutoff point that the ARC 2 has determined to the upper frequency limit of the tweeters.

**AUDYSSEY HF Roll-off 1:** this should be selected if you feel that FLAT sounds excessively bright in your room. The AUDYSSEY High Frequency Roll-off 1 curve introduces a slight roll-off at high frequencies that accounts for the balance between direct and reflected sound in small to medium-size rooms.

Both AUDYSSEY FLAT and AUDYSSEY HF Roll-off 1 target curves are also available with the Midrange Compensation, “Mid Comp,” option.

**AUDYSSEY MIDRANGE COMPENSATION (Mid Comp)** is sometimes necessary to correct the directivity differences that often occur in that frequency range due to crossover circuitry or horn-loaded speakers. Start listening to the corrected systems without Mid Comp, allow yourself to get used to the “new sound” of your studio, and then try the Mid Comp option. Listen to your favorite music, and then judge which AUDYSSEY Target Curve sounds more natural on your speakers and in your room environment.

**CUSTOM 1/4:** these user definable curves reflect the settings of the corresponding ones in the EDIT page of the plug-in.

**NOTE:** switching between target curves takes a few seconds the first time any curve is loaded. This is necessary for ARC 2 to load the corresponding file (figure 5.5). This only happens the first time the curve is loaded or when a modification is applied to one of the Custom 1-4. Switching becomes instantaneous afterwards allowing for on-the-fly, seamless switching.

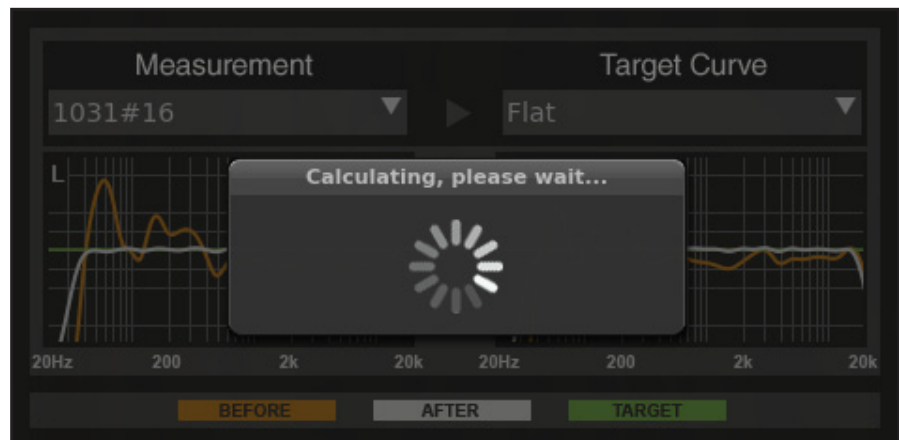

figure 5.5

# ARC System 2

## 5.1.4 Virtual Monitoring Feature

For a fast and convenient check of how your mix translates in various “real world” conditions, we've provided a set of alternative speaker responses which are listed under the Factory Target and Custom Curves in the Virtual Monitoring menu. These additional curves are real frequency responses of professional and consumer devices (famous studio speakers, TV sets, car audio, boom boxes, desktop and laptop speakers, etc.) which will let you audition how your mix translates with many different speakers. Note that while these curves provide some real world confidence and are useful for quick checks, we stress the fact that you should always refer to the Factory Target and Custom curves for the truest accuracy and highest fidelity of the correction during your recording or mixing work.

## 5.1.5 Frequency Response Graphs

The ARC 2 Plug-In shows two frequency response graphs (figure 5.6), one for the left channel and one for the right channel. Each frequency response graph shows the three color-coded curves simultaneously.

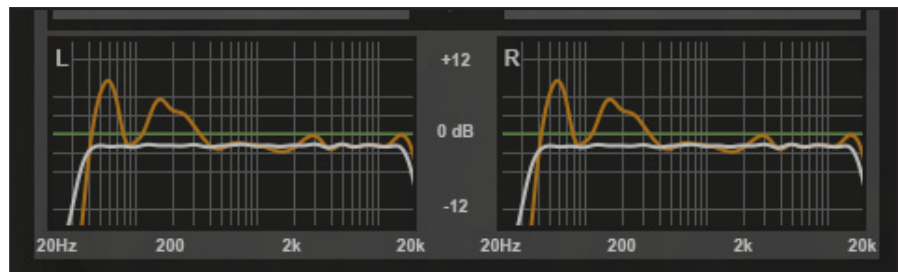

figure 5.6

**ORANGE CURVE (Before):** represents the original measured speakers/room frequency response.

**WHITE CURVE (After):** represents the corrected speakers/room frequency response.

**GREEN CURVE (Target):** represents the selected Target Curve. In figure 5.6, the selected target curve is AUDYSSEY FLAT. You can see that it is actually flat from 20 to 20,000 Hz. If one of the Custom Curves is used, this line will display its settings.

Analyze these graphs to understand where the correction curve is applied.

# ARC System 2

## 5.1.6 Speaker Icons

The ARC 2 Plug-In shows the speaker icon that has been chosen when the measurement was saved in the ARC 2 Measurement software. This is useful to identify and recall the measurement sets already taken and their association with a real speaker model. Note that the speaker icon selection is just a mnemonic aid and does not interact with the sound of the ARC System 2 in any way.

## 5.1.7 Peak Meter

This precision Peak Meter (figure 5.7) shows the INPUT level (unprocessed) or OUTPUT (processed by the ARC System).

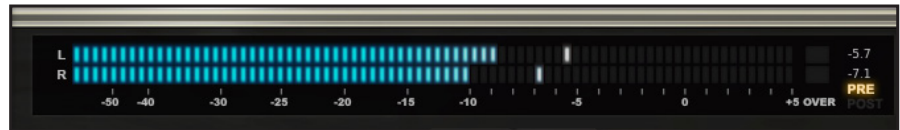

figure 5.7



figure 5.8



figure 5.9

On the Peak Meter, click PRE (figure 5.8) to check the unprocessed input signal level.

This mode is very useful to keep the actual stereo master level of your project under control. Remember that ARC 2 is changing the stereo master peak level, so the DAW output meters will not show the actual real level anymore.

Use the ARC 2 Peak Meter in PRE mode to monitor the actual project level.

On the Peak Meter, click POST (figure 5.9) to check the ARC 2 processed signal level.

## 5.1.8 Correction ON switch and TRIM knob

To enable the correction, click the CORRECTION ON switch (figure 5.10). When it is lit, the correction is active.

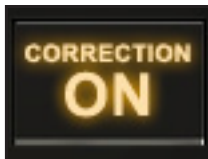

figure 5.10

**TRIM knob:** the TRIM knob (figure 5.11) adjusts the level of the corrected sound only so you can use the TRIM knob to compare the “before” and “after” sounds at an equivalent volume.



figure 5.11

We have worked to make the level difference between the corrected and uncorrected audio minimal. However, the level difference will vary depending on the frequency content and level of the program material. To further minimize this difference and match corrected and uncorrected audio levels (thus being able to fully appreciate the difference between the “before” and “after”), use this trim knob. It has a range from -6 to +6 dB, and it should be set so that the perceived loudness is the same for both the corrected and

uncorrected audio.

Once the comparison has finished, please bring back the TRIM knob to its default position (0 dB) to avoid unwanted clipping of the signal.

## 5.1.9 Other controls

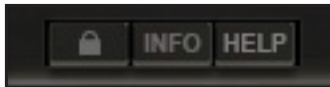

figure 5.12

**LOCK:** if you are running the software in demo mode and you click the LOCK button (figure 5.12), the Authorization Manager will appear. However, if you already registered and authorized your product, clicking the LOCK button will simply show you the product serial number (figure 5.13).

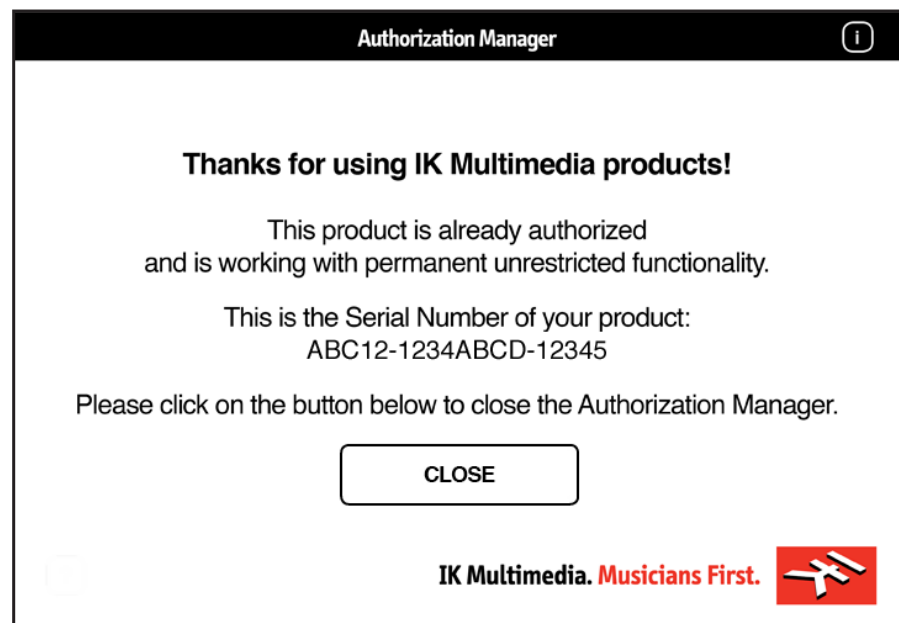

figure 5.13



figure 5.14

**INFORMATION (INFO):** by clicking the INFO button (figure 5.14), the credit interface will be displayed. Here you can check the version of your ARC 2 Plug-In. Clicking anywhere on the credit interface will close the credits and return you to the normal view.

**KEYBOARD MODIFIER:** to reset the TRIM knob to its default value, click on it while holding the ALT key.

**HELP:** click the “HELP” button to open the .pdf manual.

# ARC System 2

## 5.2 Edit Window

Sometimes after ARC 2 has compensated for your speaker response by evening out the anomalies in the room's response, the resulting “tone” or “color” can be quite different from what you are used to. You can use the controls in the Edit window (figure 5.15) to adjust it to your personal taste by dragging the green break-points in the EQ curve for gentle tone-shaping while still getting all the benefits of the ARC 2 correction.



figure 5.15

This will not alter the correction ARC 2 has applied to your monitoring setup (as you might think at first glance). It will instead allow for more tonal options to suit your listening preferences.

### 5.2.1 EQ points

Drag these break-points on the X/Y axis to boost or cut at the desired frequency (figure 5.16). Maximum range is +/-12dB. Double click on dots to reset them to 0dB.

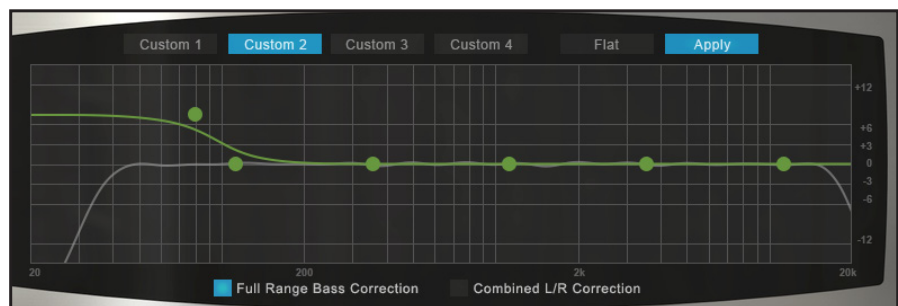

figure 5.16



## 5.2.2 Custom 1-4 buttons

These buttons (figure 5.17) select the user-defined Custom EQ Curves.

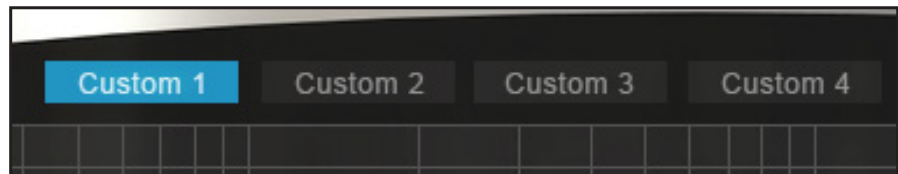

figure 5.17

You can use these customizable EQ settings to adjust your personal listening preference or to better suit different program material. These curves will retain the chosen settings after the “Apply” button has been clicked (see below); the corresponding frequency response will also be shown in the “Play Window” graphs.

## 5.2.3 Apply button

Once you have defined your Custom EQ Curve, you can use this button to apply it and listen to the effect it has on your monitoring (figure 5.18).



figure 5.18

Loading an EQ Curve takes a bit of calculation by the ARC 2 Plug-In, so this button provides a convenient way to avoid any waiting each time a Custom EQ Curve is modified.

## 5.2.4 Flat button

Use this button to reset the EQ curve to its standard flat state (figure 5.19).



figure 5.19

## 5.2.5 Combined L/R Correction

Sometimes when the ARC 2 correction is applied, you might notice a slight loss of focus in the stereo image particularly with elements panned dead-center in a mix. Even though the benefits of the correction are greatly effective, this loss of focus can be caused by some anomalies in the room

# ARC System 2

geometry, speaker positioning within the room, or even by a less-than-perfect accuracy in the measurement positions.

This can be solved by using the “Combined L/R Correction” function (figure 5.20).

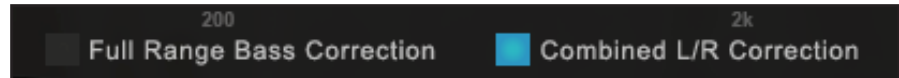

figure 5.20

When this option is selected, ARC 2 will average the correction among the L/R channels and then apply it symmetrically to the two channels to effectively restore the correct stereo image from any anomalies in the monitoring (figure 5.21).



figure 5.21

## 5.2.6 Full Range Bass Correction

The ARC System 2 automatically detects the bass roll-off point of each speaker to ensure that no correction is applied below that point as it may potentially overload speakers. However, in some rooms with especially odd low frequency issues, the ARC’s measurement system can be misled and set a Low Frequency roll-off point that is actually higher than what is really required. This results in no correction applied to low frequencies even if it was actually needed.

To address this, it is possible to disable the automatic roll-off point detection feature and allow the ARC’s correction to be applied to the entire frequency spectrum down to 20 Hz, no matter what roll-off point is detected. Please note that as a safety precaution, the maximum boost applied to the low frequency range will never be higher than 9 dB to protect your speakers from excessive boost.

To select this option, simply click the button labeled “Full Range Bass

# ARC System 2

Correction” at the bottom of the ARC 2 Edit panel (figure 5.22).

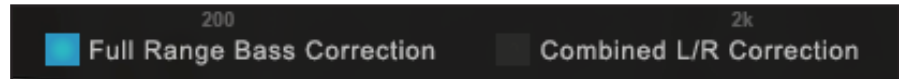

figure 5.22

In figure 5.23 and 5.24 you can see the difference in the frequency response when the full range bass correction is on and off.



figure 5.23



figure 5.24

On most rooms where the regular automatic roll-off point detection works without issues, you may notice a deeper low frequency extension of your monitoring system when Full Range Bass Correction is on, which you may find desirable.

ARC System 2 goal is to achieve the most accurate room correction possible automatically, however we suggest checking both options after various listening tests to match the preferred low frequency performance.

# ARC System 2

## 5.3 Monitor Control Window

To provide an easier, more “control room-style” monitoring system, you can use the “Monitor Window” (figure 5.25) which gives you a few key controls clearly arranged and instantly within reach.



figure 5.25

### 5.3.1 Main volume knob



figure 5.26

This control acts as the master volume of your listening environment (figure 5.26). It works on both uncorrected and corrected audio, so it can be effectively used as the overall output level in your control room or also to avoid clipping which might occur with particularly hot program material. By carefully adjusting this Master Volume control and the Trim Knob (see paragraph 5.1.7), you can get a perfect balance and consistency of levels between corrected and uncorrected audio.

### 5.3.2 Dim switch



figure 5.27

Use this switch to instantly lower the listening level by a set amount of decibels (figure 5.27). Adjust the range of the dim using the Level control which goes from 0 (no attenuation) down to -40dB.

### 5.3.3 Mute switch



figure 5.28

Use this switch to cut the sound going to your speakers (figure 5.28).

## 5.3.4 Mode selector



figure 5.29

This control lets you choose the mode in which ARC 2 will monitor your audio (figure 5.29). When set to “Stereo,” ARC 2 will reproduce the corrected L/R program on your DAW’s master bus. Setting it to “Mono” or “Side” will allow you to monitor the program in Mono (channels sum) or in Side (channels difference).

## 5.3.5 MIDI Assign of Remote Controls

All controls can be assigned to an external hardware controller sending MIDI commands for hands on-operation. To do this, just right click on the parameter you want to be remotely controlled. A “MIDI learn” message (figure 5.30) will show that ARC 2 is waiting for a MIDI input. Move the hardware controller (dial, encoder, etc..) you want to assign to it, and it will be instantly linked to the selected parameter.



figure 5.30

## 5.4 Opening the ARC 2 Plug-In in your DAW

The ARC 2 Plug-In is a “stereo-to-stereo” processor that should be inserted on the stereo master bus of your audio sequencer or digital audio workstation.

The ARC 2 Plug-In should remain inserted and active on the stereo master bus during the entire recording, mixing and mastering processes. **But then just before printing the final mix to a file or to an external recording device, it should be turned OFF.**

This is because the ARC 2 Plug-In is used to correct the monitoring/room system response. It is NOT intended to process the actual mixdown of your project.

A few DAWs support a dedicated monitoring bus where you can insert plug-ins. In this case, the ARC 2 Plug-In should be inserted on the monitoring bus instead of the stereo master bus so that the ARC 2 Plug-In will not affect the actual mixdown of your project even if you don’t turn it OFF before printing the mix.

# ARC System 2

Each DAW has its own criteria for how to use aux tracks, monitoring bus, master tracks/faders, etc. Therefore, these suggestions for how to start ARC 2 in several host applications are just a starting point, a guideline. For example, if your session already has a master track, you do not need to create another one. Just insert ARC 2 as the last plug-in. We recommend that you read your DAW manual chapters specifically related to outputs, monitoring bus, master tracks, routing configurations, etc.

Considering that DAWs are in constant update, please refer to their User Manuals to learn how to insert ARC 2 as a plug-in.

The ARC 2 Plug-In is compatible with RTAS, VST and Audio Units plug-in formats on both (where applicable) Windows and Mac OS X platforms. Please refer to the Installation and Authorization Manual for further details.

## 5.5 Using the ARC 2 Plug-In

Before using the ARC 2 Plug-In, be sure you have already saved one or more measurement sets so that you can load them in the plug-in.

1. Open your DAW.
2. Create a new session or open an existing one.
3. Open the DAW audio mixer, and locate the stereo master bus. If you are using Pro Tools and your session does not have a stereo master bus yet, please create one.
4. Load the ARC 2 Plug-In as the LAST processor on the stereo master bus.
5. From the measurements menu, select one of your saved measurement sets.
6. Select one of the Target Curves from the menu. We suggest starting with FLAT.
7. Click the Correction ON Switch. When it is lit, the correction is ON.
  - a. If you are using mastering processors (like T-RackS), be sure to insert the ARC 2 Plug-In AFTER all the other processors. The ARC 2 Plug-In must always be the LAST one in the processing chain.
  - b. If your master level is really hot, (very close to 0dB), be sure to not overload the stereo master bus with the ARC 2 processing.
  - c. If clipping occurs when checking the ARC 2 Peak Meter in POST mode, use the TRIM knob to lower the level.
8. Keep the ARC 2 Plug-In inserted on the stereo master bus throughout the entire recording, mixing and mastering process.

**IMPORTANT:** Switch the ARC 2 Plug-In OFF before bouncing the project to a disk file. Your final mix should NOT include the ARC 2 processing because it is designed for MONITORING use only.

# ARC System 2

## 5.6 Suggestions for the best ARC System 2 usage

You are probably used to how your studio acoustics sound.

For this reason – and considering that the ARC System 2 will improve the accuracy of your monitoring system and change the sound of your room – please follow these suggestions to enrich your listening experience while using the ARC System:

1. Use CDs or material you know are very familiar with to evaluate the new way your studio sounds.
2. Always give yourself time to get used to the new sound. Do not judge the corrected system by only listening for a minute or two. Always give yourself enough listening the time to understand how different the room is sounding.
3. Do not change between various measurement sets or turn the correction ON / OFF too often. Your hearing process needs to get used to it. It is like when your eyes needs some time to adapt to a very different lighting condition such as going out of a dark room into bright sunlight.

After you select the best measurement set, you will start using the ARC System 2 without even thinking it is there. It is really a “set and forget” tool that will really help you to mix faster, better, and achieve greater consistency with your artistic projects.

# ARC System 2



## Chapter 6 Frequently Asked Questions

### What is the difference between ARC 2 and other room correction EQ systems?

ARC 2 is powered by Audyssey MultEQ® XT32, a breakthrough room correction technology that takes an innovative approach at measurement and correction that other room correction EQ systems do not:

1. MultEQ® XT32 room correction technology allows you to measure multiple positions in your room to make a much wider sweet spot. Many systems only correct for one seat in the room. This typically makes other seats in the room sound worse, because a single measurement does not provide an accurate representation of the problems of the entire room.
2. MultEQ® XT32 room correction technology measures your room using advanced proprietary methods perfected with years of extensive research from the Audyssey® team. MultEQ® XT32 looks at patterns in the time domain responses and classifies them into clusters based on the similarities in those patterns, typically in 3-5 groups. A representative response is created from each cluster, and a final response is then created from grouping the representatives. The few EQ systems that do correct for multiple positions simply average the measurement results. This tends to gloss over common acoustical problems and not fix them properly.
3. MultEQ® XT32 room correction technology corrects for both time and frequency domain problems, which solves many of the problems that have plagued room correction EQ systems since their inception. Other EQ systems only correct for frequency domain problems, which leaves the time domain to cause phase distortion and smearing.
4. One of the other benefits of ARC 2 with MultEQ® XT32 is that it identifies the limits of the loudspeaker performance and does not apply correction beyond those limits. This is particularly important in the low frequencies where other systems may overcorrect and potentially damage the speakers.

### My studio already has some acoustical treatment. Will ARC 2 be useful for me?

Yes. The ARC System 2 improves the clarity and focus of the perceived sound as well, and this will partially mask untreated rooms reverberation and reflections considerably. If you already have any level of acoustical treatment in your room (and if it's done properly), it will only add to the ARC 2 correction performance, boosting the overall result of the monitor's accuracy.

# ARC System 2

## **Does ARC's results depend on the quality of monitors I use? How does the quality of my monitors affect ARC 2 results?**

ARC 2 will improve any kind of monitor type in any room at any level of quality. Of course, there are aspects of the monitors that will always translate to the final hearing experience even after applying the ARC 2 process. For example, good power handling, power amps with distortion-free performance, detail level, accuracy, and so on. ARC System 2 will improve any kind of monitor-room matching, and the higher the quality the monitors, the better the final results will be.

## **Can I use ARC System 2 if I have a subwoofer?**

Yes. Just connect your system so that ARC System 2 can measure and correct your Left and Right speakers, with the inclusion of the subwoofer. ARC System 2 will correct the subwoofer frequency ranges as well considering its emission part of the Main Left and Right monitors.

## **Will I need to change the way I am used to working with my DAW?**

No. The only difference is having the ARC 2 Plug-In always inserted on your stereo master bus (you need to turn OFF the correction when bouncing the final mix down). If you use mastering processors on the main stereo master bus make sure to put these before ARC 2. ARC 2 will always have to be the very latest processor in your audio path. A few (the list is growing) DAWs also have dedicated monitoring bus, so inserting the plug-in on this bus is the best possible option.

## **Can I use another measurement microphone instead of the included one?**

No, this is not possible. To achieve the best possible accuracy, ARC 2 must know the exact frequency response and directional pattern of the microphone used. That is why the entire system is especially calibrated to the ARC 2 Measurement Microphone and cannot be used with other measurement microphones. Using another measurement microphone with the ARC System 2 will give unpredictable results.

## **Can I use the included microphone for recordings other than for measurement?**

Yes. Measurement microphones usually exhibit a flat frequency response, at the expense of a poor sensitivity and a noise level that is too high for high quality recording. The ARC 2 Measurement Microphone exhibits a flat frequency response as well, but at the same time, the sensitivity noise level and max SPL are extremely good. So once you have measured your room, you'll be pleased by how well this microphone sounds when recording various acoustic sources. This turns

# ARC System 2

this microphone into a valuable tool that will be useful to you even after you have calibrated the room. Plus, this microphone is omnidirectional, making the proximity effect found in conventionally studio-used cardioid microphones disappear. This is important for home and project entry-level studios since omnidirectional microphones are commonly not a part of the setup.

## **Does ARC 2 work with surround monitoring systems?**

Not at the moment. A multi-channel version of ARC System 2 is development and will be available in the future.

# ARC System 2

## Chapter 7 Troubleshooting

### Where can I find my IK product Serial Number?

The Serial Number is written on the Registration Card (included with your IK product inside the license envelope) or in the E-mail you received from DigitalDelivery@ikmultimedia.com (if you purchased the product as 'Downloadable only version'). In the snapshot, please check its exact location on the Registration Card (figure 7.1).

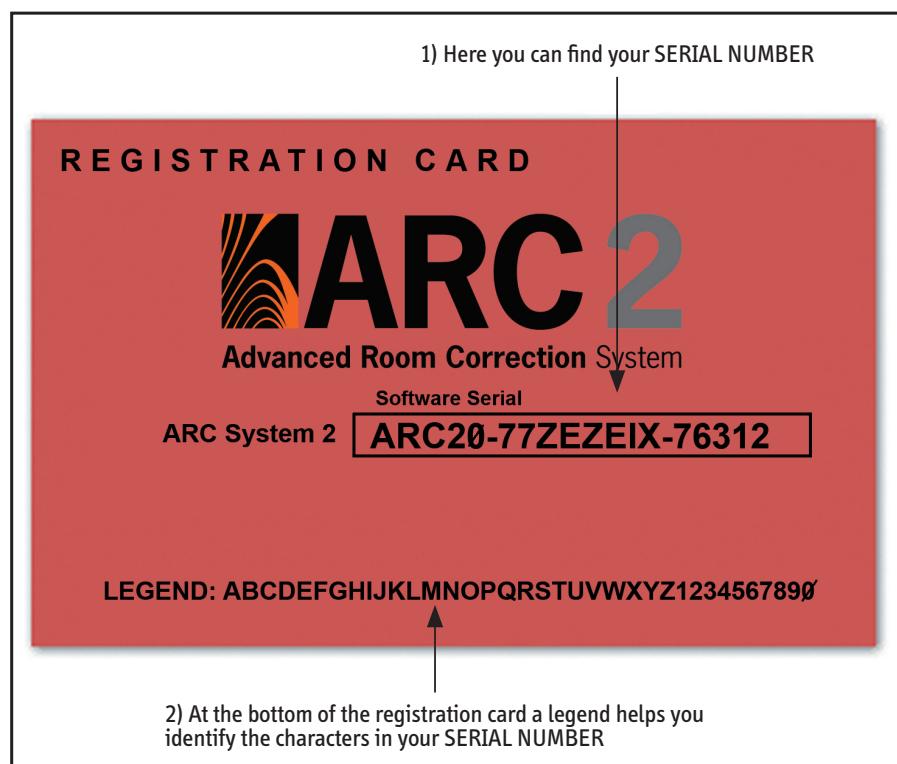

figure 7.1

For clear characters identification, please analyze the legend.

**IMPORTANT:** the number zero can easily be identified in your Serial Number because it has a line crossed through it to differentiate it from the letter "o."

### Why is the Authorization Manager rejecting my Serial Number?

Probably because of a typo, here are some common errors:

- Typing a 0 ("zero" number) instead of an O ("o" letter).
- Typing 1 ("one" number) instead of an I ("i" letter).

# ARC System 2

- Typing 2 (“two” number) instead of a Z (“z” letter).
- Typing 5 (“five” number) instead of an S (“s” letter).
- Typing 8 (“eight” number) instead of a B (“b” letter).
- Typing a “.” (point) instead of a “-” (minus).

#### Suggestions:

- If possible, please copy and paste the information.
- Cut off all the leading and trailing spaces.
- Please type all codes in UPPERCASE during the installation and registration process.
- Check that the Serial Number that you are entering is in correlation with the product installed.

#### **How can I authorize my product on another computer?**

To authorize your product on another computer just follow these instructions:

- Install the product and the Authorization Manager on that computer.
- Run the Authorization Manager.

#### **I need to log in into the User Area but I forgot my User Name and Password. What should I do?**

You can retrieve your User Area login details in two different ways:

- Run the Authorization Manager and follow the steps until you reach the login page. Here you just have to click on the ‘Forgot password?’ button and submit your email address. Your login details will be sent to your email account. In case you have checked the ‘Remember me’ checkbox before and are not able to access the login page, just click on the LOGOUT button.
- Go to **www.ikmultimedia.com**, click on ‘I forgot my username and/or password’ and submit your email address. Your login details will be sent to your email account.

#### **I just bought an IK Multimedia software product. What should I do to register and authorize my new product?**

Just run the Authorization Manager and follow the instructions.

In case you don’t have the Authorization Manager, you can download it for free from our website at: **www.ikmultimedia.com/authorizationmanager**.

# ARC System 2

**While measuring the room, I get error messages from the ARC 2 Measurement software related to the low signal and high background noise. As a result, I can't complete the measurement process. What should I do?**

Quiet down the room as much as possible, or increase the test tones playback level during the measurement process. Also, check the microphone level again, (returning to the Measurement Step 3).

**While measuring the room, I get "phase" errors from the ARC 2 Measurement software.**

Please check your speakers wiring. If the speakers are passive, check the polarity of the leads going from the amps to the speakers. If the speakers are active, check the XLR or TRS cables connections and polarities.

**When I open the measurements set on my ARC 2 Plug-In and turn the Correction ON, the resulting sound and the displayed response is strange and incorrect, making the monitors sound worse than when ARC 2 Plug-In is not enabled. Do you have any suggestions?**

Be sure that your audio interface is set to 48 kHz when running the ARC 2 Measurement software. Also, check your audio interface buffer size settings. For a proper measurement, it should be set from 128 to 2048 samples.

**I am trying to set the microphone levels on the ARC 2 Measurement software. However, even if the test signal is being played back from the speakers, I cannot see any level. What should I do?**

Please check which audio input has been selected on the ARC 2 Measurement Software Step 2, if the +48V phantom power is ON, and if the XLR cable is properly connected, (eventually, check if the cable is in good condition).

**When I open the measurements set on my ARC 2 Plug-In and turn the Correction ON, the resulting sound is not optimal, and I don't feel it is correct for my monitors and for my room.**

Please read carefully the ARC System 2 User Manual (Chapters 3 & 4), and repeat the measurement process.

# ARC System 2

**When I open the measurements set on my ARC 2 Plug-In and turn the correction ON, the resulting sound and the displayed response is strange and incorrect, making the monitors sound worse than when ARC 2 Plug-In is not enabled. Do you have any suggestions?**

Please check if the ARC 2 Measurement Microphone is working, by connecting the microphone to a +48V phantom microphone preamp and listening to it through headphones. The microphone should exhibit a neutral, clean sound. If the microphone is not working, producing loud noises, or having a very weak output signal, please contact IK Multimedia Technical Support.



## Chapter 8 Support

For any question you may have, please refer to the FAQ webpage at:  
[www.ikmultimedia.com/faq](http://www.ikmultimedia.com/faq)  
Here you will find answers to the most common questions.

To submit a Technical Support Form, go to:  
[www.ikmultimedia.com/Support.php](http://www.ikmultimedia.com/Support.php)

For other requests such as Product, Sales, or Web info, please go to:  
[www.ikmultimedia.com/ContactIKForm.php](http://www.ikmultimedia.com/ContactIKForm.php)

### 8.1 User Area

The User Area is a special section of our website specifically designed for our users' needs (figure 8.1).

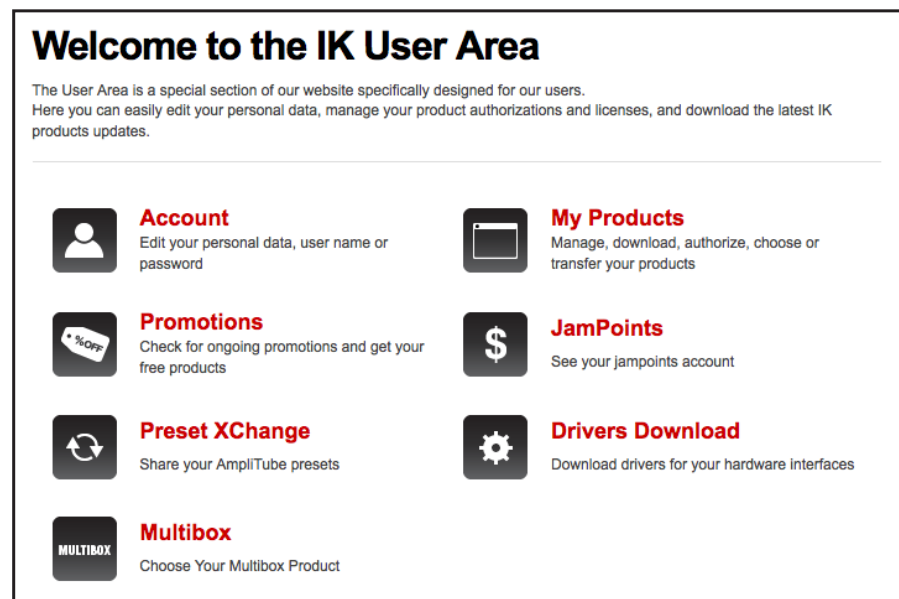

figure 8.1

If you are a member of our registered users' database, you will be able to:

- Edit your Personal data.
- Manage your product Authorization Codes.
- Download the latest products updates and free content.
- Transfer your License.
- Get your Free Products.
- Download your Sound Libraries.
- Share your AmpliTube presets.
- Check your IK JamPoints.

# ARC System 2

To access the User Area go to [www.ikmultimedia.com/userarea](http://www.ikmultimedia.com/userarea)

To enter the User Area for the first time, you have to log in with the User Name and Password that you've received from us via e-mail after your first IK product registration. If you have changed your User Name and Password, please use your most current information to log in.

ARC System™ is a trademark property of IK Multimedia Production Srl. Audyssey®, Audyssey MultEQ® XT 32 are registered trademarks property of Audyssey Laboratories™ Inc. used under license. All other product names and images, trademarks and artists names are the property of their respective owners, which are in no way associated or affiliated with IK Multimedia. Use of these names does not imply any cooperation or endorsement. Mac and the Mac logo are trademarks of Apple Computer, Inc., registered in the U.S. and other countries. Windows and the Windows logo are trademarks or registered trademarks of Microsoft Corporation in the United States and/or other countries. The Audio Units logo is a trademark of Apple Computer, Inc. VST is a trademark of Steinberg Media Technologies GmbH.  
**[www.ikmultimedia.com/arc](http://www.ikmultimedia.com/arc)**

**IK Multimedia Production Srl**, Via dell'Industria 46, 41122, Modena, Italy.  
Phone: +39-059-285496 - Fax: +39-059-2861671  
**IK Multimedia US LLC**, 1153 Sawgrass Corporate Pkwy. Sunrise, FL 33323  
Phone: (954) 846-9101 - Fax: (954) 846-9077  
**[www.ikmultimedia.com](http://www.ikmultimedia.com)**

All specifications are subject to change without further notice.

IK Multimedia. **Musicians First.**

