





Intended to alert the user to the presence of uninsulated “dangerous voltage” within the product’s enclosure that may be of sufficient magnitude to constitute a risk of electric shock to persons.



Intended to alert the user of the presence of important operating and maintenance (servicing) instructions in the literature accompanying the product.

CAUTION: Risk of electrical shock — DO NOT OPEN!

CAUTION: To reduce the risk of electric shock, do not remove cover. No user serviceable parts inside. Refer servicing to qualified service personnel.

WARNING: To prevent electrical shock or fire hazard, do not expose this appliance to rain or moisture. Before using this appliance, read the operating guide for further warnings.



Este símbolo tiene el propósito, de alertar al usuario de la presencia de “(voltaje) peligroso” sin aislamiento dentro de la caja del producto y que puede tener una magnitud suficiente como para constituir riesgo de descarga eléctrica.



Este símbolo tiene el propósito de alertar al usuario de la presencia de instrucciones importantes sobre la operación y mantenimiento en la información que viene con el producto.

PRECAUCION: Riesgo de descarga eléctrica ¡NO ABRIR!

PRECAUCION: Para disminuir el riesgo de descarga eléctrica, no abra la cubierta. No hay piezas útiles dentro. Deje todo mantenimiento en manos del personal técnico cualificado.

ADVERTENCIA: Para evitar descargas eléctricas o peligro de incendio, no deje expuesto a la lluvia o humedad este aparato. Antes de usar este aparato, lea más advertencias en la guía de operación.



Ce symbole est utilisé dans ce manuel pour indiquer à l'utilisateur la présence d'une tension dangereuse pouvant être d'amplitude suffisante pour constituer un risque de choc électrique.



Ce symbole est utilisé dans ce manuel pour indiquer à l'utilisateur qu'il ou qu'elle trouvera d'importantes instructions concernant l'utilisation et l'entretien de l'appareil dans le paragraphe signalé.

ATTENTION: Risques de choc électrique — NE PAS OUVRIR!

ATTENTION: Afin de réduire le risque de choc électrique, ne pas enlever le couvercle. Il ne se trouve à l'intérieur aucune pièce pouvant être réparée par l'utilisateur. Confiez l'entretien et la réparation de l'appareil à un réparateur Peavey agréé.

AVERTISSEMENT: Afin de prévenir les risques de décharge électrique ou de feu, n'exposez pas cet appareil à la pluie ou à l'humidité. Avant d'utiliser cet appareil, lisez attentivement les avertissements supplémentaires de ce manuel.



Dieses Symbol soll den Anwender vor unisolierten gefährlichen Spannungen innerhalb des Gehäuses warnen, die von Ausreichender Stärke sind, um einen elektrischen Schlag verursachen zu können.



Dieses Symbol soll den Benutzer auf wichtige Instruktionen in der Bedienungsanleitung aufmerksam machen, die Handhabung und Wartung des Produkts betreffen.

VORSICHT: Risiko — Elektrischer Schlag! Nicht öffnen!

VORSICHT: Um das Risiko eines elektrischen Schlages zu vermeiden, nicht die Abdeckung entfernen. Es befinden sich keine Teile darin, die vom Anwender repariert werden könnten. Reparaturen nur von qualifiziertem Fachpersonal durchführen lassen.

ACHTUNG: Um einen elektrischen Schlag oder Feuergefahr zu vermeiden, sollte dieses Gerät nicht dem Regen oder Feuchtigkeit ausgesetzt werden. Vor Inbetriebnahme unbedingt die Bedienungsanleitung lesen.

IMPORTANT SAFETY INSTRUCTIONS

WARNING: When using electrical products, basic cautions should always be followed, including the following:

1. Read these instructions.
2. Keep these instructions.
3. Heed all warnings.
4. Follow all instructions.
5. Do not use this apparatus near water.
6. Clean only with a dry cloth.
7. Do not block any of the ventilation openings. Install in accordance with manufacturer's instructions.
8. Do not install near any heat sources such as radiators, heat registers, stoves or other apparatus (including amplifiers) that produce heat.
9. Do not defeat the safety purpose of the polarized or grounding-type plug. A polarized plug has two blades with one wider than the other. A grounding type plug has two blades and a third grounding plug. The wide blade or third prong is provided for your safety. If the provided plug does not fit into your outlet, consult an electrician for replacement of the obsolete outlet.
10. Protect the power cord from being walked on or pinched, particularly at plugs, convenience receptacles, and the point they exit from the apparatus.
11. Note for UK only: If the colors of the wires in the mains lead of this unit do not correspond with the terminals in your plug, proceed as follows:
 - a) The wire that is colored green and yellow must be connected to the terminal that is marked by the letter E, the earth symbol, colored green or colored green and yellow.
 - b) The wire that is colored blue must be connected to the terminal that is marked with the letter N or the color black.
 - c) The wire that is colored brown must be connected to the terminal that is marked with the letter L or the color red.
12. Only use attachments/accessories provided by the manufacturer.
13. Use only with a cart, stand, tripod, bracket, or table specified by the manufacturer, or sold with the apparatus. When a cart is used, use caution when moving the cart/apparatus combination to avoid injury from tip-over.
14. Unplug this apparatus during lightning storms or when unused for long periods of time.
15. Refer all servicing to qualified service personnel. Servicing is required when the apparatus has been damaged in any way, such as power-supply cord or plug is damaged, liquid has been spilled or objects have fallen into the apparatus, the apparatus has been exposed to rain or moisture, does not operate normally, or has been dropped.
16. Never break off the ground pin. Write for our free booklet "Shock Hazard and Grounding." Connect only to a power supply of the type marked on the unit adjacent to the power supply cord.
17. If this product is to be mounted in an equipment rack, rear support should be provided.
18. Exposure to extremely high noise levels may cause a permanent hearing loss. Individuals vary considerably in susceptibility to noise-induced hearing loss, but nearly everyone will lose some hearing if exposed to sufficiently intense noise for a sufficient time. The U.S. Government's Occupational Safety and Health Administration (OSHA) has specified the following permissible noise level exposures:

Duration Per Day In Hours	Sound Level dBA, Slow Response
8	90
6	92
4	95
3	97
2	100
1 1/2	102
1	105
1/2	110
1/4 or less	115

According to OSHA, any exposure in excess of the above permissible limits could result in some hearing loss. Ear plugs or protectors to the ear canals or over the ears must be worn when operating this amplification system in order to prevent a permanent hearing loss, if exposure is in excess of the limits as set forth above. To ensure against potentially dangerous exposure to high sound pressure levels, it is recommended that all persons exposed to equipment capable of producing high sound pressure levels such as this amplification system be protected by hearing protectors while this unit is in operation.

SAVE THESE INSTRUCTIONS!

KB® 1

Thank you for selecting the KB® 1 keyboard amplifier. The Peavey KB 1 is perfect for practice, pre-gig warm-ups, songwriting or any application where quality sound is important, but a large, bulky unit is just too much. The design of the KB 1 makes it a compact workhorse amplifier for keyboardists, acoustic guitar players and other musicians needing full-range output in a small package. At 20 Watts RMS, the KB 1's heavy-duty 8" speaker gets the job done! And for situations that require headphones, the KB 1 delivers. Two channels are provided, featuring 1/4" inputs, level controls, and two-band active equalization (Low, High). The front panel headphone jack automatically disables the internal speaker when connected.

Special attention was given to make the KB 1 as compact and light as possible to maximize portability, yet provide a "big" sound. Go ahead...pick it up! At 17.4 lbs., it's perfect for "on-the-go" projects. And the size? Well, let's say it'll fit just about anywhere.

Like all of the KB Series, the KB 1 is built for the road. First, extremely tough black covering is provided along with heavy-duty corners. Second, a serious handle is available at the top of the unit. Third, a heavy-duty metal grille is provided to protect the speaker.

This amp is for real. Check it out---it's all there...sound, portability, roadworthy design. Also, with every KB series amplifier, you get Peavey's excellent five-year warranty (check the warranty document at the end of the manual for full details), and the best in customer service from Peavey's award-winning repair and service department.

FRONT PANEL

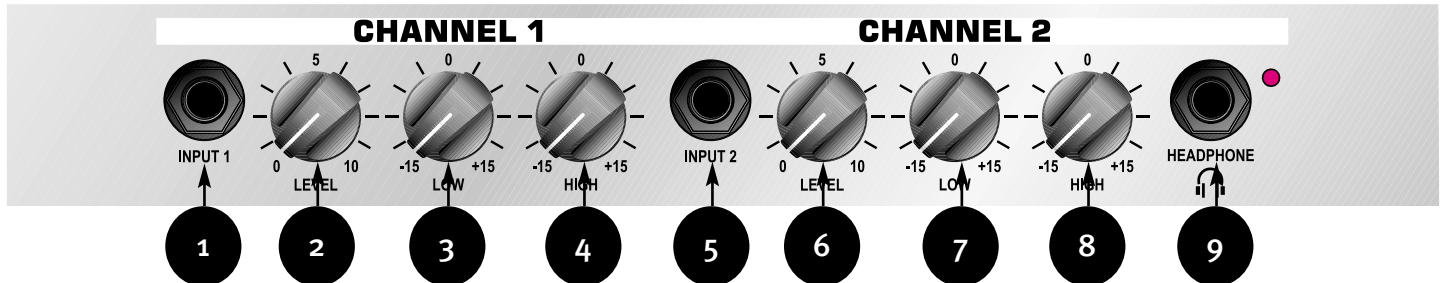

CHANNEL ONE

1. INPUT

Signal input for Channel One. This 1/4" jack input will accept signals from a variety of keyboard and acoustic instruments.

2. LEVEL

Controls the Channel One 1/4" phone jack input level.

3. LOW EQUALIZATION

An active tone control (shelving type +/-15 dB) for boosting or cutting the bass frequency range. **CAUTION:** Excessive low frequency boost can damage the speaker.

4. HIGH EQUALIZATION

An active tone control (shelving type +/-15 dB) for boosting or cutting the treble frequency range.

CHANNEL TWO

5. INPUT

Signal input for Channel Two. This 1/4" jack input will accept signals from a variety of keyboard and acoustic instruments.

6. LEVEL

Controls the Channel Two 1/4" phone jack input level.

7. **LOW EQUALIZATION**
An active tone control (shelving type +/-15 dB) for boosting or cutting the bass frequency range. **CAUTION:** Excessive low frequency boost can damage the speaker.
8. **HIGH EQUALIZATION**
An active tone control (shelving type +/-15 dB) for boosting or cutting the treble frequency range.
9. **HEADPHONE JACK**
A headphone jack is provided for stereo headphones. This switching jack disengages the internal speaker when plugged in.

REAR PANEL

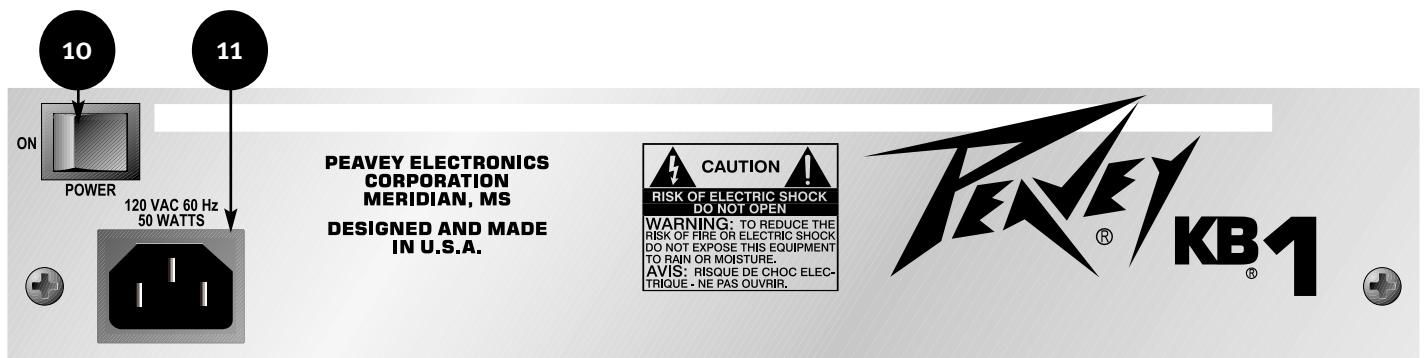

10. **POWER SWITCH**
On/Off switch. The red pilot light illuminates when the unit is turned on.
11. **IEC CONNECTOR/DETACHABLE LINE CORD**
This is a standard IEC power connector. An AC mains cord having the appropriate AC plug and ratings for the intended operating voltage is included in the carton. The main cord should be connected to the amplifier before connecting to a suitable AC outlet.
12. **Maintain a clearance of 12" from any combustibile surface.**

KB™ 1

SPECIFICATIONS

Rated power and load:

20 W RMS into 4 Ohms

Power @ clipping (typical):

(5% THD, 1 kHz, 120 VAC line)
20 W RMS into 4 Ohms

Total harmonic distortion:

Less than 0.5%, 100 mW to
12 W RMS, 60 Hz to 10 kHz,
4 Ohms (typically below
0.2%)

Power consumption:

50 Watts, 50/60 Hz, 120 VAC

PREAMP SECTION:

The following specs are
measured @ 1 kHz with the
master EQ flat @ 0 dB.

Nominal values are with
levels @ 5

Minimum values are with
levels @ 10

INSTRUMENT INPUTS:**Input impedance:**

220 K Ohms

Nominal input level:

-4.5 dBV, 600 mV RMS

Minimum input level:

-20.6 dBV, 93 mV RMS

Maximum input level:

+12 dBV, 4V RMS

Frequency response:

+0, -2 dB, 50 Hz to 10 kHz

HEADPHONE OUTPUT

(Stereo headphone jack, mono
signal)

Load impedance:

4 Ohms or greater

Nominal power output:

20 mW into 4 Ohms

(Switching jack disconnects the
internal speaker when plug is
inserted)

System hum and noise:

80 dBV (both channels
operating)

Equalization (both channels):

±15 dB @80 Hz and 8 kHz,
shelving

Weight and dimensions:

Weight: 17.4 lbs. (7.89 kg)

Width: 13.75" (349 mm)

Depth: 9.0" (229 mm)

Height: 14.25" (362 mm)

KB™ 1 BLOCK DIAGRAM

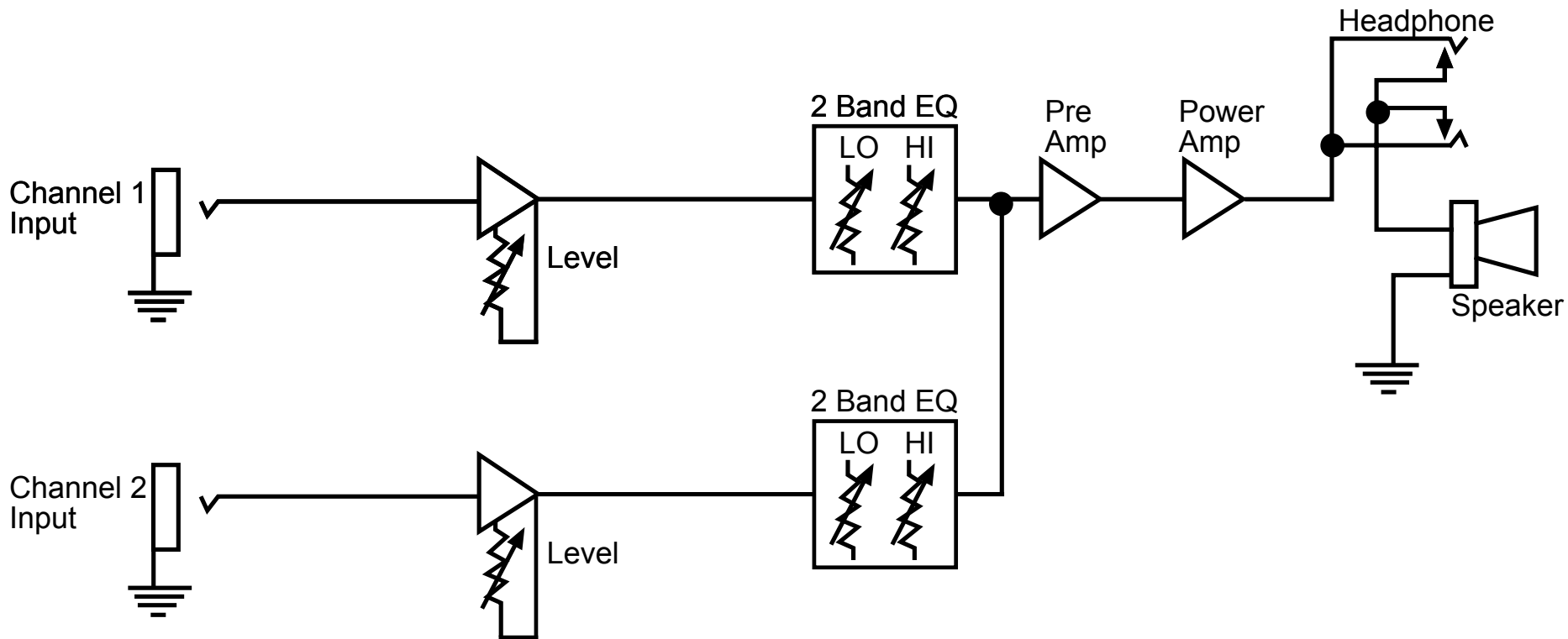

KB/A™ 15

Gracias por elegir el amplificador acústico/de teclado KB/A™ 15. El amplificador Peavey KB/A 15 es ideal para la práctica, el precalentamiento previo a un concierto, la composición de canciones o cualquier aplicación en la que la calidad del sonido es importante, pero no es conveniente una unidad de tamaño abultado. El diseño del amplificador KB/A 15 lo convierte en un amplificador compacto de trabajo para tecladistas, guitarristas acústicos y otros músicos que necesitan salida de gama completa en un paquete pequeño. A 15 vatios RMS (eficaces), el altavoz de servicio pesado de 8 pulgadas del KB/A 15 responde plenamente. Asimismo, en las situaciones que requieren auriculares, el amplificador KB/A 15 también cumple su función. Se proporcionan dos canales, con entradas de 1/4 de pulgada, controles de nivel y ecualización activa de dos bandas (graves y agudos). Adicionalmente, el Canal Uno cuenta con un interruptor de Brillo. El enchufe hembra para auriculares del panel frontal desactiva automáticamente el altavoz interno cuando se conecta.

Se prestó especial atención a fin de hacer el KB/A 15 lo más compacto y liviano posible para maximizar la portabilidad y brindar al mismo tiempo un sonido “grande”. ¡Adelante... tómelo! Con sus 6,3 kg (14 libras), es perfecto para los proyectos “sobre la marcha”. ¿Y el tamaño? Bueno, digamos que cabe casi en cualquier sitio.

Como todos los amplificadores de la serie KB/A, el KB/A 15 está construido para el camino. Primero, tiene una cubierta negra extremadamente robusta, con esquinas reforzadas. Segundo, la unidad dispone de una resistente manija en la parte superior. Tercero, se suministran patas de goma para servicio pesado a fin de proteger la parte inferior.

Este amplificador es una realidad. Comprébelo... tiene todo: sonido, portabilidad, diseño para viajar por los caminos. Asimismo, con todos los amplificadores de la serie KB/A, usted obtiene la excelente garantía de Peavey por un año (para conocer todos los detalles, consulte el documento de garantía al final del manual) y lo mejor en servicio al cliente por parte del galardonado departamento de reparaciones y servicio de Peavey.

PANEL FRONTAL

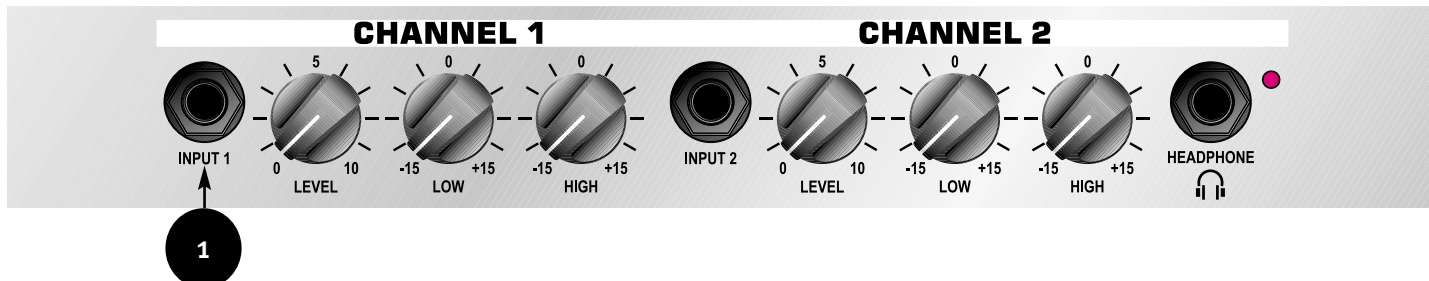

CANAL UNO

- 1. ENTRADA**
Entrada de señal del Canal Uno. Esta entrada con enchufe hembra de 1/4 de pulgada acepta señales de una variedad de teclados e instrumentos acústicos.
- 2. NIVEL**
Controla el nivel de entrada del enchufe hembra fonográfico de 1/4 de pulgada del Canal Uno.
- 3. INTERRUPTOR DE BRILLO**
Activa el refuerzo de las frecuencias de las gamas media y de agudos.
- 4. ECUALIZACION DE GRAVES**
Control activo de tono (tipo escalonado, ± 15 dB) para reforzar o recortar la gama de frecuencias graves. Precaución: El refuerzo excesivo de las frecuencias graves puede dañar el altavoz.
- 5. ECUALIZACION DE AGUDOS**
Control activo de tono (tipo escalonado, ± 15 dB) para reforzar o recortar la gama de frecuencias agudas.

CANAL DOS

- 6. ENTRADA**
Entrada de señal del Canal Dos. Esta entrada con enchufe hembra de 1/4 de pulgada acepta señales de una variedad de teclados e instrumentos acústicos.
- 7. NIVEL**
Controla el nivel de entrada del enchufe hembra fonográfico de 1/4 de pulgada del Canal Dos.
- 8. ECUALIZACION DE GRAVES**
Control activo de tono (tipo escalonado, ± 15 dB) para reforzar o recortar la gama de frecuencias graves. Precaución: El refuerzo excesivo de las frecuencias graves puede dañar el altavoz.
- 9. ECUALIZACION DE AGUDOS**
Control activo de tono (tipo escalonado, ± 15 dB) para reforzar o recortar la gama de frecuencias agudas.

PANEL TRASERO

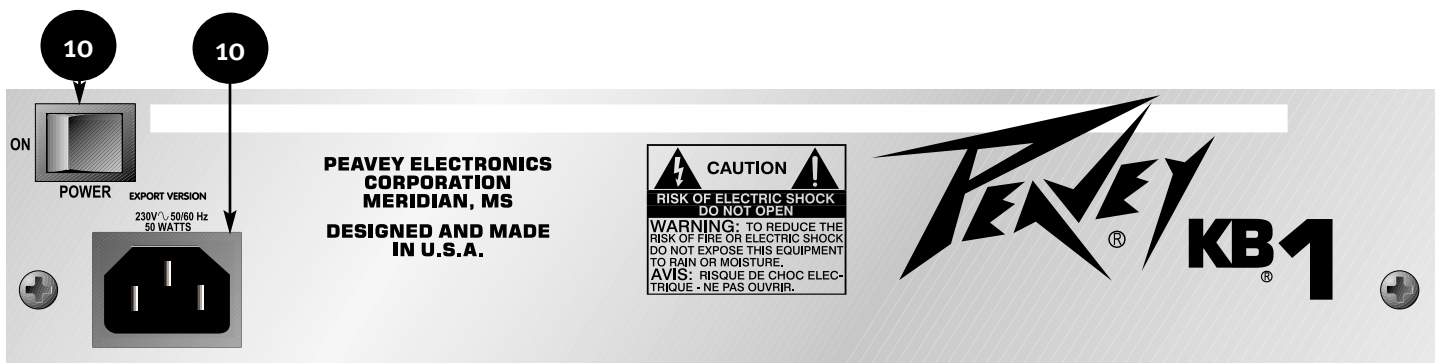

CONTROLES MAESTROS

- 10. ENCHUFE HEMBRA PARA AURICULARES**
Se proporciona un enchufe hembra para auriculares estéreo. Cuando se inserta, el interruptor de este enchufe desconecta el altavoz interno.
- 11. INTERRUPTOR DE ENCENDIDO**
Interruptor de encendido/apagado. La luz piloto roja se ilumina cuando se enciende la unidad.
- 12. Cable de alimentación de CA**
Este cable de alimentación de línea alimenta CA a la unidad. Conecte el cable de alimentación de línea a una fuente de CA con la conexión correcta a tierra. Si se emplea una tensión de línea inadecuada, pueden producirse daños en el equipo (vea la tensión de línea indicada en la unidad). Nunca elimine el terminal de conexión a tierra del enchufe del cable de alimentación.

KB™ 1

ESPECIFICACIONES

Rated power and load:

20 W RMS into 4 Ohms

Power @ clipping (typical):

(5% THD, 1 kHz, 120 VAC line)
20 W RMS into 4 Ohms

Total harmonic distortion:

Less than 0.5%, 100 mW to
12 W RMS, 60 Hz to 10 kHz,
4 Ohms (typically below
0.2%)

Power consumption:

50 Watts, 50/60 Hz, 120 VAC

PREAMP SECTION:

The following specs are
measured @ 1 kHz with the
master EQ flat @ 0 dB.

Nominal values are with
levels @ 5

Minimum values are with
levels @ 10

INSTRUMENT INPUTS:**Input impedance:**

220 K Ohms

Nominal input level:

-4.5 dBV, 600 mV RMS

Minimum input level:

-20.6 dBV, 93 mV RMS

Maximum input level:

+12 dBV, 4V RMS

Frequency response:

+0, -2 dB, 50 Hz to 10 kHz

HEADPHONE OUTPUT

(Stereo headphone jack, mono
signal)

Load impedance:

4 Ohms or greater

Nominal power output:

20 mW into 4 Ohms

(Switching jack disconnects the
internal speaker when plug is
inserted)

System hum and noise:

80 dBV (both channels
operating)

Equalization (both channels):

±15 dB @80 Hz and 8 kHz,
shelving

Weight and dimensions:

Weight: 17.4 lbs. (7.89 kg)

Width: 13.75" (349 mm)

Depth: 9.0" (229 mm)

Height: 14.25" (362 mm)

KB/A™ 15

Merci d'avoir choisi le KB/A™ 15 de Peavey. Cet ampli de clavier/instrument acoustique est parfait pour les répétitions, les prises de son avant les spectacles, la composition de musique et toutes les applications où un son de haute qualité est important mais où un gros équipement n'est pas nécessaire. La conception du KB/A 15 en fait un amplificateur universel compact pour joueurs de claviers et de guitares acoustiques, ainsi que pour tout musicien exigeant une gamme complète de sons dans un petit coffret. Avec ses 15 Watts RMS, le haut-parleur robuste de 20 cm (8 po.) du KB/A 15 délivre le son voulu. Il est également parfait dans les situations où un casque d'écoute est nécessaire. Il est équipé de deux canaux offrant des entrées de 6,3 mm (1/4 po.), des réglages de niveau et une égalisation active à deux bandes (hautes et basses fréquences). Le canal One (Un) offre de surcroît un commutateur de Bright. Le jack pour casque d'écoute du panneau avant désactive automatiquement le haut-parleur interne lorsqu'un casque y est branché.

De grands efforts ont été faits pour rendre le KB/A 15 aussi compact et léger que possible afin de faciliter son transport sans pour autant sacrifier la puissance du son. Allez-y, soulevez-le ! Avec ses 7 kilos, il est parfait pour les tournées. Sa taille? Disons qu'il se glisse partout.

Comme tous les amplis de la Série KB/A, le KB/A est construit pour tenir la route : preuve en est son habillage en tissu noir très résistant avec coins renforcés, sa poignée robuste sur le dessus, et ses pieds en caoutchouc résistant, qui protègent le fond du coffret.

Non, vous ne rêvez pas, cet ampli offre vraiment tout ce dont vous avez besoin: qualité et puissance du son, facilité de transport et conception adaptée aux tournées. De surcroît, comme pour tous les amplis de la série KB/A, vous bénéficierez de l'excellente garantie d'un an de Peavey (pour de plus amples détails, consultez le formulaire de garantie à la fin du manuel), et d'une exceptionnelle assistance à la clientèle par le service de réparations et maintenance de Peavey.

PANNEAU AVANT

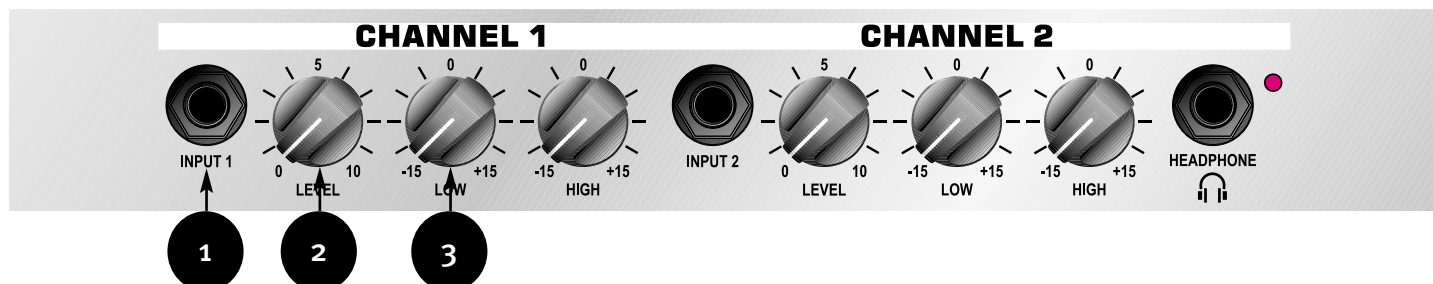

CANAL ONE (UN)

- 1. ENTREE**
Entrée des signaux du canal One. Ce jack d'entrée de 6,3 mm (1/4 po.) accepte les signaux de divers types de claviers et d'instruments acoustiques.
- 2. NIVEAU**
Permet de régler le niveau des signaux d'entrée au jack de 6,3 mm (1/4 po.) du Canal One.
- 3. COMMUTATEUR DE BRIGHT**
Permet d'augmenter les fréquences moyennes et aiguës.
- 4. EGALISATION DES BASSES FREQUENCES**
Commande de tonalité active (type shelving +/- 15 dB) permettant d'augmenter ou couper la gamme des basses fréquences. Attention : l'augmentation excessive des basses risque d'endommager le haut-parleur.
- 5. EGALISATION DES HAUTES FREQUENCES**
Commande de tonalité active (type shelving +/- 15 dB) permettant d'augmenter ou couper la gamme des fréquences aiguës.

CANAL TWO (DEUX)

- 6. ENTREE**
Entrée des signaux du canal Two. Ce jack d'entrée de 6,3 mm (1/4 po.) accepte les signaux de divers types de claviers et d'instruments acoustiques.
- 7. NIVEAU**
Permet de régler le niveau des signaux d'entrée au jack de 6,3 mm (1/4 po.) du Canal One.
- 8. EGALISATION DES BASSES FREQUENCES**
Commande de tonalité active (type shelving +/- 15 dB) permettant d'augmenter ou couper la gamme des basses fréquences. Attention : l'augmentation excessive des basses risque d'endommager le haut-parleur.
- 9. EGALISATION DES HAUTES FREQUENCES**
Commande de tonalité active (type shelving +/- 15 dB) permettant d'augmenter ou couper la gamme des fréquences aiguës.

PANEL TRASERO

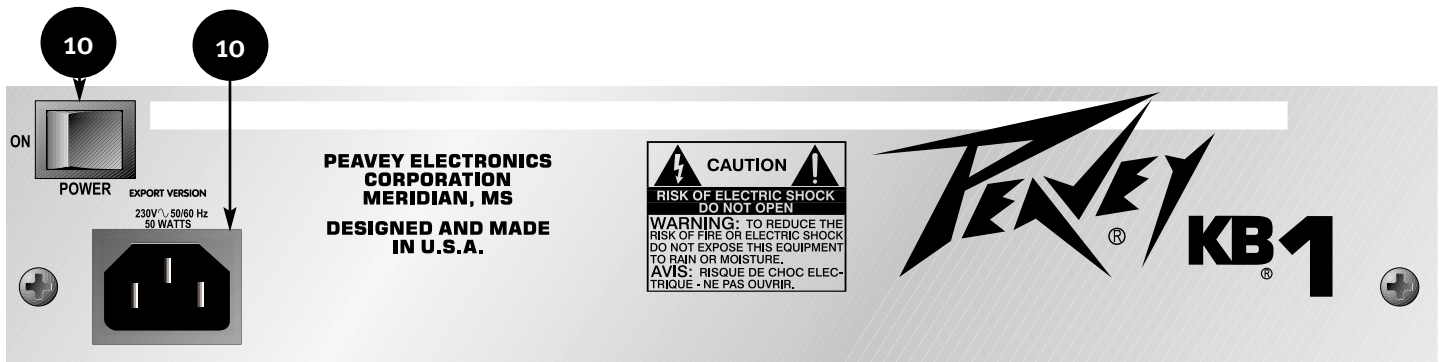

MASTER

10. **JACK DE CASQUE D'ECOUTE**
Un jack pour casque d'écoute est fourni pour casque stéréo. Ce jack commutable désactive le haut-parleur interne lorsqu'il est branché.
11. **INTERRUPTEUR MARCHE/ARRET**
Le voyant rouge est allumé lorsque l'ampli est sous tension.
12. **Cordon d'alimentation**
Ce cordon est fourni avec l'appareil. L'alimentation secteur doit être correctement reliée à la terre. Utilisez une source d'alimentation dont le voltage correspond à celui inscrit sur l'appareil. Dans le cas contraire, l'appareil peut être endommagé. Ne déconnectez jamais la connexion à la terre.

KB™ 1

SPECIFICATIONS

Rated power and load:

20 W RMS into 4 Ohms

Power @ clipping (typical):

(5% THD, 1 kHz, 120 VAC line)
20 W RMS into 4 Ohms

Total harmonic distortion:

Less than 0.5%, 100 mW to
12 W RMS, 60 Hz to 10 kHz,
4 Ohms (typically below
0.2%)

Power consumption:

50 Watts, 50/60 Hz, 120 VAC

PREAMP SECTION:

The following specs are
measured @ 1 kHz with the
master EQ flat @ 0 dB.

Nominal values are with
levels @ 5
Minimum values are with
levels @ 10

INSTRUMENT INPUTS:**Input impedance:**

220 K Ohms

Nominal input level:

-4.5 dBV, 600 mV RMS

Minimum input level:

-20.6 dBV, 93 mV RMS

Maximum input level:

+12 dBV, 4V RMS

Frequency response:

+0, -2 dB, 50 Hz to 10 kHz

HEADPHONE OUTPUT

(Stereo headphone jack, mono
signal)

Load impedance:

4 Ohms or greater

Nominal power output:

20 mW into 4 Ohms

(Switching jack disconnects the
internal speaker when plug is
inserted)

System hum and noise:

80 dBV (both channels
operating)

Equalization (both channels):

±15 dB @80 Hz and 8 kHz,
shelving

Weight and dimensions:

Weight: 17.4 lbs. (7.89 kg)

Width: 13.75" (349 mm)

Depth: 9.0" (229 mm)

Height: 14.25" (362 mm)

KB/A™ 15

Wir freuen uns, daß Sie sich für den Kauf des Keyboard/Akustik-Verstärker KB/A™ 15 entschieden haben. Er eignet sich ideal zum Üben, zum Einspielen vor dem Konzert, Komponieren und für andere Anwendungen, bei denen es auf Klangqualität ankommt, wo aber kein Platz ist für ein großes, sperriges Gerät. Dank seiner kompakten Ausführung ist der KB/A 15 die erste Wahl bei Musikern, die Keyboard, akustische Gitarre und andere Instrumente spielen und umfassende Ausdruckskraft in einem kleinen Format wünschen. Mit 15 Watt eff. wird der 8" (20 cm) Hochleistungslautsprecher des KB/A 15 diesen Anforderungen gerecht. Und für Situationen, in denen ein Kopfhörer benötigt wird, ist der KB/A 15 geradezu ideal. Zwei Kanäle sind vorhanden und bieten 6,3 mm Eingänge, Pegelregler und aktive Equalization in zwei Frequenzbereichen (Low, Hi); zusätzlich ist Kanal 1 mit einem Bright-Schalter ausgestattet. Die Kopfhörerbuchse an der Frontplatte schaltet den internen Lautsprecher automatisch aus, wenn ein Stecker eingesteckt wird.

Es ging unseren Ingenieuren insbesondere darum, den KB/A 15 so kompakt und leicht wie möglich zu bauen, um optimale Mobilität zu gewährleisten, ohne dabei Kompromisse beim Sound einzugehen. Überzeugen Sie sich selbst! Mit seinen 6,3 kg ist er perfekt für unterwegs. Und die Größe? Dank seiner kompakten Abmessungen paßt der KB/A 15 praktisch überall hin.

Der KB/A 15 ist, wie alle Geräte der KB/A Serie, für den Tournee-Einsatz gebaut. So weist er z.B. einen extrem robusten, schwarzen Bezug sowie belastbare Eckenbeschläge auf. Der Griff an der Oberseite ist äußerst belastbar, und großdimensionierte Gummifüße sorgen für überragende Standsicherheit. Dieser Verstärker hat es in sich! Check it out: Klang, Tragbarkeit, robuste Ausführung – hier stimmt einfach alles! Wie auf alle anderen Verstärkern der KB/A-Serie erhalten Sie auch auf den KB/A 15 ein Jahr Garantie (Einzelheiten finden Sie in den Garantiebestimmungen am Ende dieser Anleitung) und den ausgezeichneten Kundendienst von Peaveys preisgekrönter Reparatur- und Kundendienstabteilung.

PANNEAU AVANT

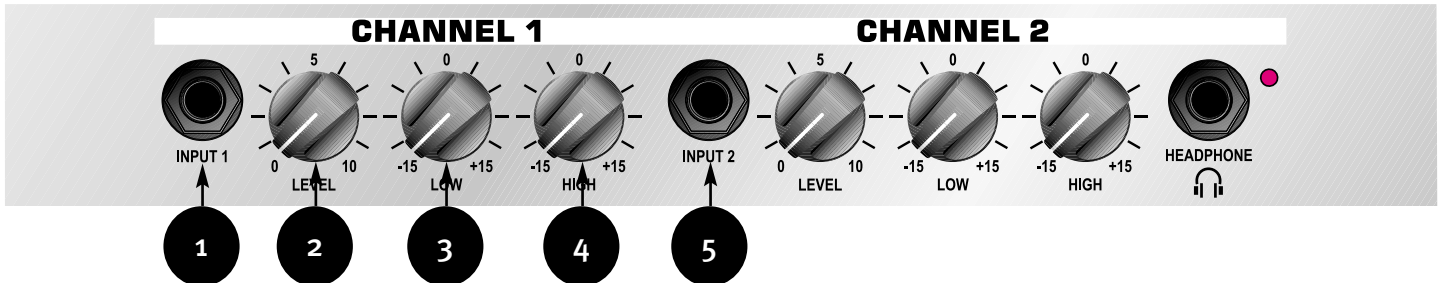

KANAL 1

- 1. EINGANG**
Signaleingang für Kanal 1. Über diese 6,3 mm Eingangsbuchse können Signale von einer Vielzahl von Keyboards und akustischen Instrumenten zugeführt werden.
- 2. PEGEL**
Regelt den Eingangspegel der 6,3 mm Klinkenbuchse von Kanal 1.
- 3. BRIGHT-SCHALTER**
Bewirkt eine Anhebung der mittleren und hohen Frequenzen.
- 4. TIEFEN-EQUALIZATION**
Aktiver Klangregler (Stufenausführung, +/-15 dB) zum Anheben und Absenken des tiefen Frequenzbereichs. Vorsicht: Durch übermäßige Anhebung der tiefen Frequenzen kann der Lautsprecher beschädigt werden.
- 5. HÖHEN-EQUALIZATION**
Aktiver Klangregler (Stufenausführung, +/-15 dB) zum Anheben und Absenken des hohen Frequenzbereichs.

KANAL 2

- 6. EINGANG**
Signaleingang für Kanal 2. Über diese 6,3 mm Eingangsbuchse können Signale von einer Vielzahl von Keyboards und akustischen Instrumenten zugeführt werden.
- 7. PEGEL**
Regelt den Eingangspegel der 6,3 mm Klinkenbuchse von Kanal 2.
- 8. TIEFEN-EQUALIZATION**
Aktiver Klangregler (Stufenausführung, +/-15 dB) zum Anheben und Absenken des tiefen Frequenzbereichs. Vorsicht: Durch übermäßige Anhebung der tiefen Frequenzen kann der Lautsprecher beschädigt werden.
- 9. HÖHEN-EQUALIZATION**
Aktiver Klangregler (Stufenausführung, +/-15 dB) zum Anheben und Absenken des hohen Frequenzbereichs.

PANNEAU ARRIERE

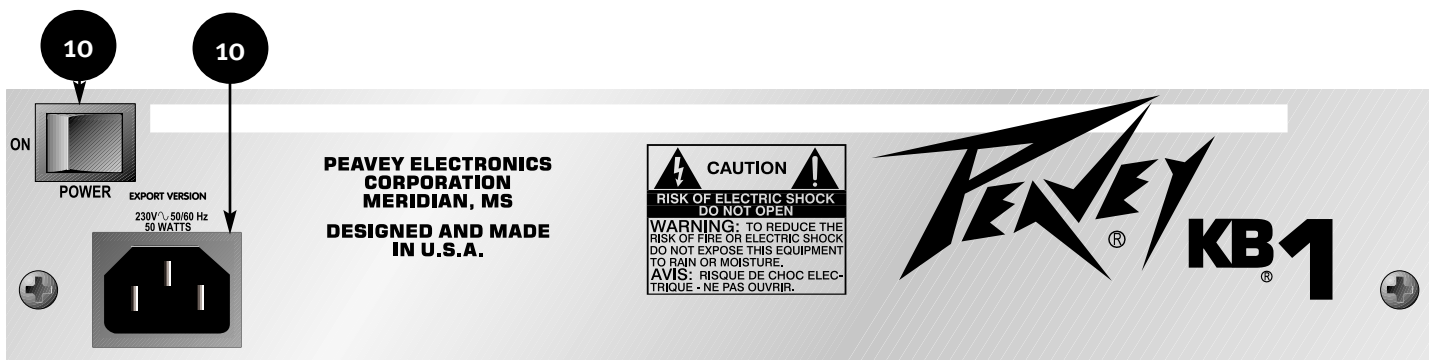

MASTER

10. KOPFHÖRERBUCHSE

Eine Kopfhörerbuchse zum Anschließen eines Stereokopfhörers ist vorhanden. Diese Schaltbuchse schaltet den internen Lautsprecher aus, wenn ein Stecker eingesteckt wird.

11. NETZSCHALTER

Ein/Aus-Schalter. Die rote Kontrolllampe leuchtet, wenn das Gerät eingeschaltet ist.

12. Fest installierte Netzkabel:

Verbinden Sie das Netzkabel mit der geerdeten Steckdose. Achten Sie auf die Angaben, die auf der Rückseite des Gerätes die Stromversorgung betreffen. Verwenden Sie kein Stromnetz, welches nicht diesen Angaben entspricht.

KB™ 1

SPÉCIFICATIONS

Rated power and load:

20 W RMS into 4 Ohms

Power @ clipping (typical):

(5% THD, 1 kHz, 120 VAC line)
20 W RMS into 4 Ohms

Total harmonic distortion:

Less than 0.5%, 100 mW to
12 W RMS, 60 Hz to 10 kHz,
4 Ohms (typically below
0.2%)

Power consumption:

50 Watts, 50/60 Hz, 120 VAC

PREAMP SECTION:

The following specs are
measured @ 1 kHz with the
master EQ flat @ 0 dB.

Nominal values are with
levels @ 5

Minimum values are with
levels @ 10

INSTRUMENT INPUTS:**Input impedance:**

220 K Ohms

Nominal input level:

-4.5 dBV, 600 mV RMS

Minimum input level:

-20.6 dBV, 93 mV RMS

Maximum input level:

+12 dBV, 4V RMS

Frequency response:

+0, -2 dB, 50 Hz to 10 kHz

HEADPHONE OUTPUT

(Stereo headphone jack, mono
signal)

Load impedance:

4 Ohms or greater

Nominal power output:

20 mW into 4 Ohms

(Switching jack disconnects the
internal speaker when plug is
inserted)

System hum and noise:

80 dBV (both channels
operating)

Equalization (both channels):

±15 dB @80 Hz and 8 kHz,
shelving

Weight and dimensions:

Weight: 17.4 lbs. (7.89 kg)

Width: 13.75" (349 mm)

Depth: 9.0" (229 mm)

Height: 14.25" (362 mm)

Notes:

Notes:

PEAVEY ELECTRONICS CORPORATION LIMITED WARRANTY

EFFECTIVE DATE: JULY 1, 1998

What This Warranty Covers

Your Peavey Warranty covers defects in material and workmanship in Peavey products purchased and serviced in the U.S.A. and Canada.

What This Warranty Does Not Cover

The Warranty does not cover: (1) damage caused by accident, misuse, abuse, improper installation or operation, rental, product modification or neglect; (2) damage occurring during shipment; (3) damage caused by repair or service performed by persons not authorized by Peavey; (4) products on which the serial number has been altered, defaced or removed; (5) products not purchased from an Authorized Peavey Dealer.

Who This Warranty Protects

This Warranty protects only the original retail purchaser of the product.

How Long This Warranty Lasts

The Warranty begins on the date of purchase by the original retail purchaser. The duration of the Warranty is as follows:

Product Category	Duration
Guitars/Basses, Amplifiers, Pre-Amplifiers, Mixers, Electronic Crossovers and Equalizers	2 years *(+ 3 years)
Drums	2 years *(+ 1 year)
Enclosures	3 years *(+ 2 years)
Digital Effect Devices and Keyboard and MIDI Controllers	1 year *(+ 1 year)
Microphones	2 years
Speaker Components (incl. speakers, baskets, drivers, diaphragm replacement kits and passive crossovers) and all Accessories	1 year
Tubes and Meters	90 days

[*Denotes additional warranty period applicable if optional Warranty Registration Card is completed and returned to Peavey by original retail purchaser within 90 days of purchase.]

What Peavey Will Do

We will repair or replace (at Peavey's discretion) products covered by warranty at no charge for labor or materials. If the product or component must be shipped to Peavey for warranty service, the consumer must pay initial shipping charges. If the repairs are covered by warranty, Peavey will pay the return shipping charges.

How To Get Warranty Service

- (1) Take the defective item and your sales receipt or other proof of date of purchase to your Authorized Peavey Dealer or Authorized Peavey Service Center. OR
- (2) Ship the defective item, prepaid, to Peavey Electronics Corporation, International Service Center, 412 Highway 11 & 80 East, Meridian, MS 39301 or Peavey Canada Ltd., 95 Shields Court, Markham, Ontario, Canada L3R 9T5. Include a detailed description of the problem, together with a copy of your sales receipt or other proof of date of purchase as evidence of warranty coverage. Also provide a complete return address.

Limitation of Implied Warranties

ANY IMPLIED WARRANTIES, INCLUDING WARRANTIES OF MERCHANTABILITY AND FITNESS FOR A PARTICULAR PURPOSE, ARE LIMITED IN DURATION TO THE LENGTH OF THIS WARRANTY.

Some states do not allow limitations on how long an implied warranty lasts, so the above limitation may not apply to you.

Exclusions of Damages

PEAVEY'S LIABILITY FOR ANY DEFECTIVE PRODUCT IS LIMITED TO THE REPAIR OR REPLACEMENT OF THE PRODUCT, AT PEAVEY'S OPTION. IF WE ELECT TO REPLACE THE PRODUCT, THE REPLACEMENT MAY BE A RECONDITIONED UNIT. PEAVEY SHALL NOT BE LIABLE FOR DAMAGES BASED ON INCONVENIENCE, LOSS OF USE, LOST PROFITS, LOST SAVINGS, DAMAGE TO ANY OTHER EQUIPMENT OR OTHER ITEMS AT THE SITE OF USE, OR ANY OTHER DAMAGES WHETHER INCIDENTAL, CONSEQUENTIAL OR OTHERWISE, EVEN IF PEAVEY HAS BEEN ADVISED OF THE POSSIBILITY OF SUCH DAMAGES.

Some states do not allow the exclusion or limitation of incidental or consequential damages, so the above limitation or exclusion may not apply to you.

This Warranty gives you specific legal rights, and you may also have other rights which vary from state to state.

If you have any questions about this warranty or service received or if you need assistance in locating an Authorized Service Center, please contact the Peavey International Service Center at (601) 483-5365 / Peavey Canada Ltd. at (905) 475-2578.

FEATURES AND SPECIFICATIONS SUBJECT TO CHANGE WITHOUT NOTICE.



Features and specifications subject to change without notice.

Peavey Electronics Corporation • 711 A Street • Meridian, MS 39301
(601) 483-5365 • FAX (601) 486-1278 • www.peavey.com



80305057