



Understanding and Using Your

moogerfooger®

CP-251 Control Processor



moog™

Moog Music Inc. Asheville, NC USA  
©2000, 2003 by Moog Music Inc.



Welcome to the world of moogerfooger® Analog Effects Modules! Your Model CP251 Control Processor is a rugged, professional-quality instrument, designed to be equally at home on stage or in the studio. Its great functionality and classic effects come from its state-of-the-art all-analog circuitry, designed and built under Bob Moog's personal direction.

Your CP251 is a direct descendent of the original modular Moog™ synthesizers. It contains a total of eight independent control signal generating and processing functions. Used with other moogerfoogers, voltage-controlled analog synthesizers, MIDI-to-CV converters, or other devices that produce or accept analog control signals, the CP251 enables you to create an amazing variety of dynamic synthesizer effects.

The following pages will first introduce voltage control, which is the basic technical principle underlying modular analog synthesizers. Next we'll describe each of the CP251's eight functions. After that, you'll find a few typical patches, which will give you some good ideas about how you can use the CP251 with your voltage-controlled gear. At the end of this booklet you'll find technical specifications, service and warranty information, and information about Moog Music.

**CONTENTS**

**BASIC THEORY - - - - - 3**

**GETTING STARTED - TOUR OF THE MODULES - 6**

**USING THE CP251 WITH MF-SERIES DEVICES - 15**

**TECHNICAL INFORMATION - - - - - 24**

**WARRANTY INFORMATION - - - - - 27**

## **SOME BASIC THEORY**

When you first try out an audio processor like a ring modulator or phaser, you plug your instrument into the AUDIO IN jack, connect the AUDIO OUT jack to your amplifier, and immediately hear what it does by playing your instrument.

There are no AUDIO IN or AUDIO OUT jacks on the CP251. This is because it is not designed to process audio (musical sounds). Rather, it processes control signals, those electrical voltages which act as 'phantom hands', changing the performance parameters on your voltage-controlled equipment with speed and precision. The use of control signals to produce interesting musical effects is called voltage control.

We'll begin with a brief discussion of voltage control, followed by a tour of the CP251's functions. This will provide enough information for you to explore all the features of your CP251. Then, after the section where we show some useful patches, we'll provide more detailed technical information for those who are interested.

## **WHAT IS VOLTAGE CONTROL?**

Imagine an oscillator module. An oscillator produces a signal that repeats regularly. If it repeats between 20 and 20,000 times a second, then we hear it as a pitched tone. Figure 1 shows a simple oscillator with a signal output jack and a frequency control knob. The oscillator signal appears at the output jack, and the oscillator frequency may be varied by turning the knob. The knob on our oscillator is calibrated in Hertz (one Hz. = one cycle per second). If you feed the oscillator output to an input on your amplifier, you'll hear a tone whose pitch goes from low to high as you turn the knob clockwise.

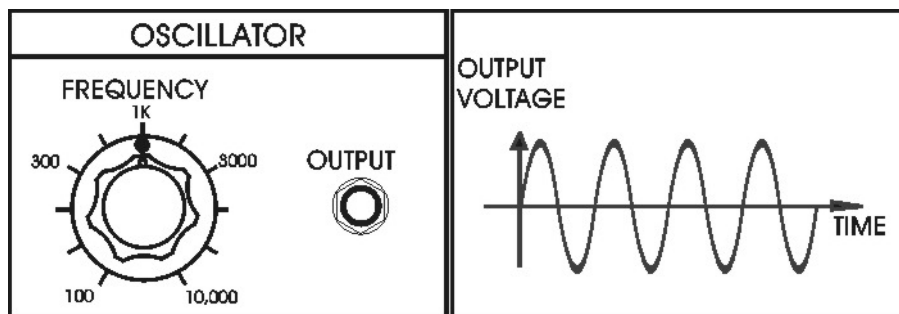

Figure 1 - LEFT: Simple oscillator with a signal output jack and a frequency control knob; RIGHT: Waveform that appears at the OUTPUT jack.

Now imagine that we add a frequency control input jack to the oscillator. You can apply an electrical voltage to this jack. As you increase the voltage, say from zero volts to +5 volts, the oscillator frequency increases (See Figure 2). In other words, increasing the voltage at the frequency control input of the oscillator has the same effect as turning the oscillator's frequency knob clockwise. You can use either the knob or the

control input jack to change the oscillator's frequency, or you can use both together. We call this kind of oscillator a voltage-controlled oscillator (VCO). The voltage applied to the frequency control input is called (you guessed it) the frequency control voltage or, since the pitch that we hear is directly related to the frequency of the oscillator's signal, the pitch control voltage.

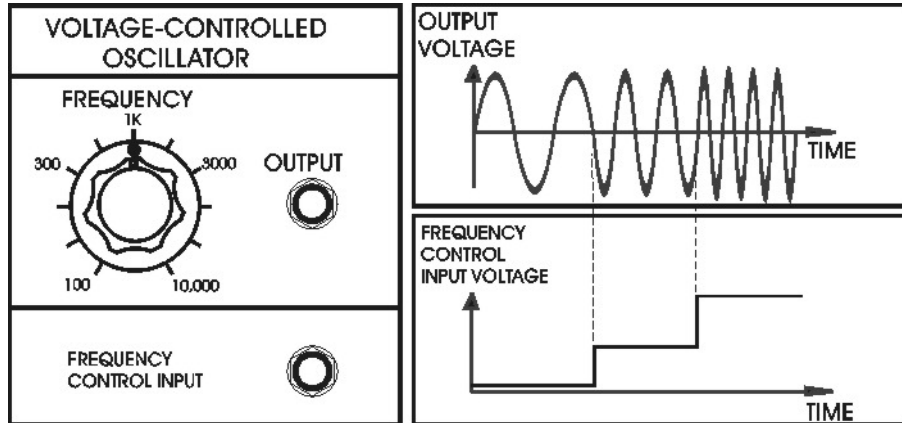

Figure 2 - LEFT: Panel of a simple voltage-controlled oscillator; LOWER RIGHT: Graph showing steps in frequency control voltage; UPPER RIGHT: Graph showing resulting increase in frequency of output.

In a system of analog synthesizer modules, control signals come from a variety of sources. For instance, a keyboard produces a series of different voltages, depending on which key the player depresses. When applied to control a VCO, such a keyboard pitch control signal produces the pitches of a chromatic scale. Another example is a low-frequency oscillator (LFO) which produces waveforms with frequencies that extend below the audio range. When applied to control a VCO, an LFO signal sweeps the VCO frequency periodically over a range that is determined by how strong the LFO signal is. If, for instance, we set the LFO frequency to about six times a second, and set the LFO amplitude (strength) to a small fraction of a volt, the VCO output is a now a pitched tone with vibrato.

Suppose we want to use both a keyboard and an LFO to control a VCO. That is, suppose we want to play a scale in which every tone has a vibrato. To accomplish this, we need to combine the keyboard and LFO signals so that they both affect the frequency of the VCO. We do this with a mixer module. A mixer for processing control signals is similar to an audio mixer. They both combine two or more signals. The main difference between them is that an audio mixer is designed to process frequencies within the range of hearing. Generally, an audio mixer is not able to process either an LFO signal or a keyboard signal, because these vary more slowly than audio signals. A mixer for control signals, on the other hand, is designed to process signals that vary slowly, or even remain steady. (Technical note: The term for such a mixer is a Direct-Coupled Mixer. It is called that because there are no capacitors in the mixer's signal path to limit its low frequency response.)

Figure 3 shows how we might connect a VCO, an LFO, and a keyboard in a modular system, to enable the player to produce a chromatic scale with vibrato. The mixer has two inputs, one of which is equipped with an input level control. The LFO signal is patched to the mixer input that has the level control, and the keyboard signal is patched to the mixer input without a level control. The output of the mixer is then

applied to the VCO's pitch control input. The mixer in Figure 3 contains a circle with a "+" in it. This is a way of showing that the two input signals are combined, or added together. The player adjusts the LFO Frequency (sometimes called Rate) knob to change the vibrato rate, the Mixer Input Level control to change the amount of vibrato, and the VCO Frequency control to transpose the pitch range of the keyboard.

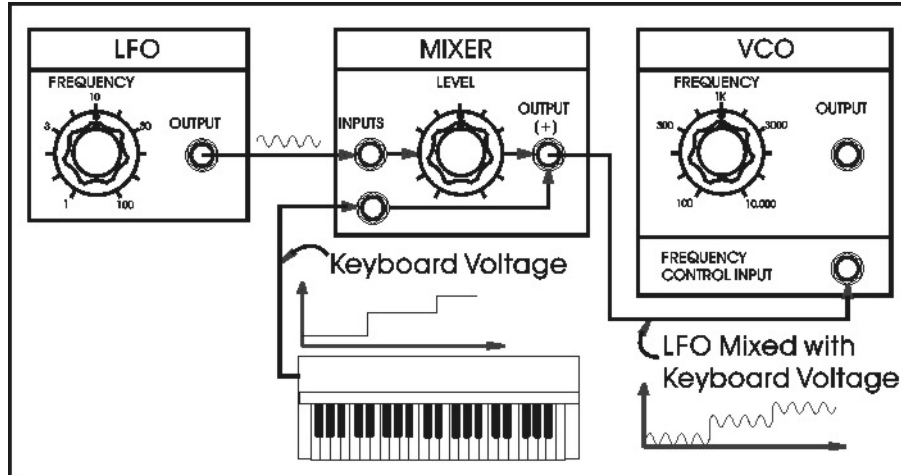

Figure 3 - Using a mixer circuit to combine LFO and KEYBOARD control signals. Output of VCO is a series of pitches with vibrato.

Varying the frequency of an oscillator is just one way to control a module's operation by means of an externally-applied control voltage. Some other ways are: varying the gain of a voltage-controlled amplifier (VCA), varying the cutoff frequency of a voltage-controlled filter (VCF), and varying the attack and decay times of a voltage-controlled envelope generator (VCEG). In the case of moogerfooger MF-Series Analog Effects Modules, all performance parameters are voltage-controllable by expression pedals or externally-applied control voltages.

A wide assortment of signal sources may be used as control voltages. In addition to LFO's and analog keyboards, commonly-used sources include envelope generators, envelope followers, sample-and-hold circuits, expression pedals, and MIDI-to-CV converters. In fact, virtually any source of variable voltage may be used as a control voltage, including custom-made and homemade control interfaces.

## **GETTING STARTED**

We are about to embark on a tour of your CP251's functions. To do this, you'll need the following items:

- Your CP251,
- A tone generator of some sort, whose frequency is voltage-controlled,
- An expression pedal such as the moogerfooger EP-1,
- Six or eight short (1'-3') patch cords with ¼" phone plugs,
- A monitor amplifier-speaker.

We'll feed the CP251's signals into the tone generator's frequency control input, and then listen to how the generator's pitch changes. This will help us visualize the CP251's signals. In the rest of this manual, we'll use **VCTG** as an abbreviation for "**Voltage Controlled Tone Generator**".

What can you use as the VCTG? Here are three candidates:

- Use an analog synthesizer with a pitch control input. The classic Minimoog™ and Micromoog™ are good examples. Set the instrument so it produces a steady tone at a pitch of around middle C, and apply the CP251's signals to the instrument's pitch control input.
- Use a moogerfooger MF101 Lowpass Filter. Set MIX to 10, CUTOFF to 250, and RESONANCE to 10. (These settings cause the filter to oscillate at its cutoff frequency.) Use the CUTOFF jack as the pitch control input, and patch the filter's AUDIO OUT to the input of your amplifier.
- Use the Carrier Oscillator section of a moogerfooger MF102 Ring Modulator. Set the MF102's LO-HI switch to HI and the FREQUENCY knob slightly above 120. Use the FREQ. jack as the pitch control input, and patch the CARRIER OUT jack to the input of your amplifier.

### ***Setting up for the Tour:***

Unpack your CP251. Set it next to your VCTG. Have your supply of short patch cords handy. Connect an audio cable from the tone generator's output to your monitor amplifier's input. Turn up the amplifier's gain just enough to verify that you're getting a tone.

Verify that your power adapter has a nominal rating of +9 volts. Plug the power adapter's cord into either power receptacle on the CP251 (There is a power receptacle on the back panel, below the moogerfooger trademark, and another receptacle on the CP251's bottom panel.) Then plug the power adapter itself into a power voltage

receptacle. (See Page 28 for more detailed information on power adapters for the CP251.) Note that the LED in the LFO section lights up.

Before we begin on our tour, let's look at two of the CP251's features.

### ***Placing your CP-251:***

Unlike the moogerfooger MF-Series effects modules, the CP251 is housed in a low rectangular enclosure. It's designed to be used in conjunction with one or more MF-Series modules and/or other voltage-controlled gear, and to be placed where it is most convenient. Where you place it in your setup will depend primarily on how you arrange the rest of your gear. One possibility is to place the CP251 behind your effects modules, so the patch cords to the modules are short. A second possibility is to place the CP251 on a table or stand, and run longer patch cords to your voltage-controlled gear. In this way, you can "play" your CP251 with your hands during performance. A third possibility is that you can custom-mount your CP251 in an equipment rack. With its wood end-caps removed, your CP251 is exactly the right size for a 3-unit high, half-rack space. Note that there is a second +9V power input jack on the CP251's bottom plate, which can be used when the unit is rack-mounted.

### ***The "Red Jacks"***

Eight of the CP251's jacks are held with red nuts. These input jacks are equipped with power for expression pedals. You can plug an expression pedal directly into any of these jacks - or use the jacks as conventional inputs. The CP251 jacks with black nuts do not supply power for expression pedals.

Let's now begin our CP251 tour. We'll begin with the LFO module, which is a control signal source.

## **LOW FREQUENCY OSCILLATOR**

An LFO (Low Frequency Oscillator) provides repeating waveforms that may be used for control and timing in voltage-controlled systems. The LFO in your CP251 provides two waveforms: triangular and square. The output jacks are labeled with graphic symbols that indicate the waveforms.

The RATE knob varies the speed of the LFO's waveforms over the range of one cycle every five seconds (0.2 Hz.), to 50 cycles per second (50 Hz.). The LED brightness follows the triangular waveform, thereby providing a visual indication of the rate. The PEDAL IN jack is a control input which may be used to voltage-control the LFO rate.

- Connect a patch cord from the LFO's triangular output, to the pitch control input of your VCTG.
- Set the RATE knob to mid position.

Note that the resulting pitch fluctuation is very wide, usually covering as much as five

octaves. Turn the RATE knob slowly to hear the LFO's full speed range.

- Turn the RATE knob counterclockwise.
- Plug an expression pedal into the PEDAL IN jack.

Vary the setting of the pedal to hear its effect on the LFO speed.

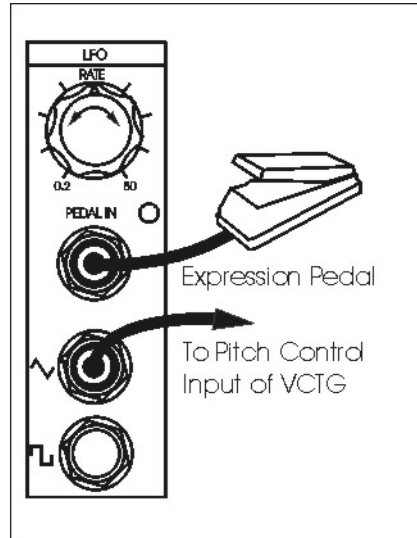

Figure 4 - Setup for trying out the LFO module.

## ATTENUATORS

An ATTENUATOR cuts down the strength of a signal. Your CP251 has two identical attenuators, each of which has an input jack, an output jack, and a knob. When the knob is fully clockwise, the full input signal is available at the output.

- Connect patch cords as follows:

- From the triangular output of the LFO to the input of one ATTENUATOR,
- From the ATTENUATOR output to the VCTG pitch control input.

- Set the knobs as follows:

- LFO RATE to mid position, and
- ATTENUATOR full clockwise.

You should hear the pitch vary over several octaves. Now turn the ATTENUATOR knob counterclockwise. Note that the width of the pitch variation decreases. When the ATTENUATOR knob is fully counterclockwise, you will not hear any pitch variation from the LFO signal.

Next, remove the first patch cord from the LFO's triangular output, and plug it into the



LFO's square wave output. Turn the ATTENUATOR knob back and forth. Note that the shape of the effect is determined by the signal that is fed to the ATTENUATOR's input, and the amount or intensity of the effect is determined by the setting of the ATTENUATOR knob. This is generally true for all control signal sources and all control destinations on voltage-controlled devices.

Now we'll illustrate a patch that uses both attenuators.

- Connect more patch cords as follows:

a) from the OUT jack of the second ATTENUATOR, to the PEDAL IN of the LFO.

b) Plug the expression pedal into the IN jack of the second ATTENUATOR.

Set the second ATTENUATOR knob to about "9 o'clock". Now the first ATTENUATOR knob is varying the strength of the LFO control signal, and the second ATTENUATOR knob is varying the amount that the expression pedal is changing the LFO rate.

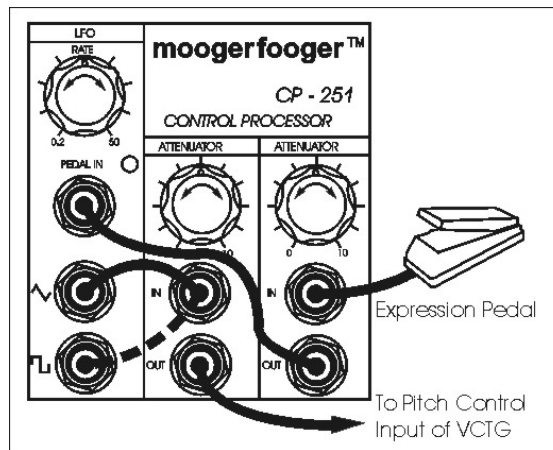

Figure 5 - Setup for trying out the ATTENUATOR modules.

## FOUR-INPUT MIXER

A MIXER combines, or adds together, two or more signals. Your CP251's Four-Input Mixer has four input jacks, labeled 1 through 4. Inputs 1 and 2 have input attenuator knobs, while inputs 3 and 4 are mixed in without attenuation. The OFFSET knob raises or lowers the voltage of the mix, while the MASTER knob determines the amplitude of the entire mix. There are two output jacks, labeled "+" and "-". The "-" output is the negative of the "+" output. That is, the voltage at the "-" output goes down when the voltage at the "+" output goes up, and vice versa.

- Connect patch cords as follows:

a) from the LFO triangular output to MIXER input 1,

b) from the LFO square output to MIXER input 2,

c) from the MIXER "+" output to the VCTG pitch control input.

- Set knobs as follows:

a) All four MIXER knobs to midposition,

b) LFO RATE to 9 o'clock.

A mixture of triangular and square waveforms will be modulating your tone generator. Vary the setting of the "1" knob to change the strength of the triangular wave, the "2" knob to change the strength of the square wave, the OFFSET knob to raise and lower the waveforms, and the MASTER knob to change the amplitude of the entire mix.

Plug your expression pedal into input 3. Note that the pedal raises and lowers the waveforms. However, if you plug the pedal into input 4, it won't work, because input 3 is a red jack and input 4 is not, and only red jacks are equipped to activate an expression pedal.

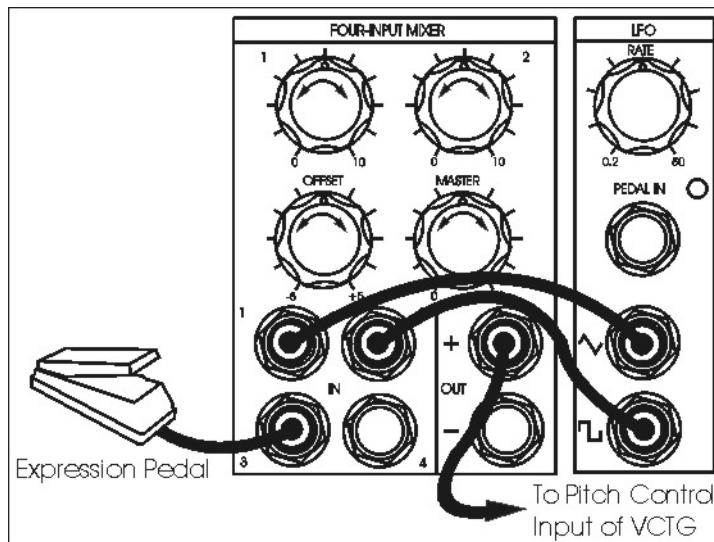

Figure 6 - Setup for trying out the Four Input Mixer

## LAG PROCESSOR

The Lag Processor provides a means of slowing down a rapidly-changing control waveform. The RISE knob varies the rate at which the rising part of a waveform is slowed down, while the FALL knob varies the rate at which the descending part of a waveform is slowed down.

- Connect patch cords as follows:

a) from the LFO square output to the LAG IN,

b) from the LAG OUT to an ATTENUATOR IN jack,

c) from the ATTENUATOR OUT jack to your VCTG pitch control input.

- Set knobs as follows:

a) both RISE and FALL fully counterclockwise,

b) ATTENUATOR knob to midposition,

c) RATE to 9 o'clock.

Note that the waveform sounds perfectly square. Now turn the RISE knob slowly clockwise. Note that the rising portion of the square wave is being slowed down. Next turn the RISE knob back to full counterclockwise and the FALL knob slowly clockwise. Note that the falling portion of the square wave is being slowed down. Experiment with various combinations of settings of the RISE and FALL knobs. Finally, experiment with the settings of the RATE and the ATTENUATOR knobs to see their effect. Listen carefully to the effect of each knob.

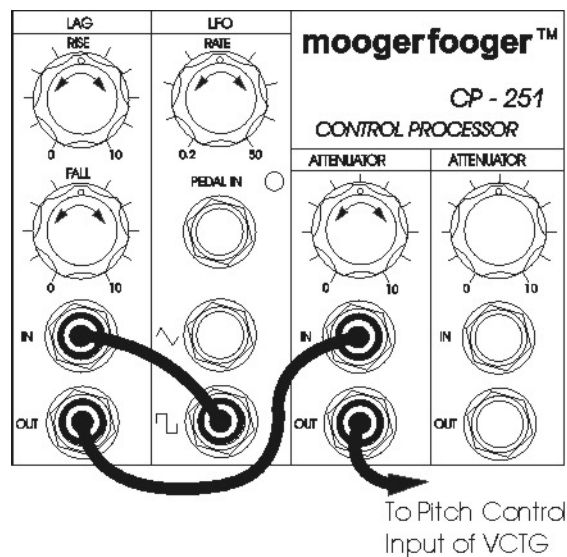

Figure 7 - Setup for trying out the Lag Processor.

## FOUR WAY MULTIPLE

The FOUR WAY MULTIPLE is a group of four jacks that are connected together. It enables one control signal source to be sent to more than one destination. One of the jacks is a red jack, so the control signal source can be an expression pedal. Plug your expression pedal into the red jack of the FOUR WAY MULTIPLE. The pedal's voltage now appears at all of the other three jacks.

- Connect patch cords as follows:

- a) from one of the unused MULTIPLE jacks, to the IN jack of an ATTENUATOR,
- b) from the ATTENUATOR OUT jack, to the PEDAL IN jack of the LFO.

These connections enable the expression pedal to control the LFO rate. The rate range is determined by the setting of the attenuator knob.

- Connect more patch cords as follows:

- a) from an unused MULTIPLE jack to INPUT 1 of the MIXER,
- b) from the LFO TRIANGULAR output to INPUT 2 of the MIXER,
- c) from the MIXER "+" output to your VCTG pitch control input.

Set all the MIXER knobs to mid-position. These connections combine the pedal voltage with the LFO triangular waveform.

Now step on the expression pedal. Note that the tone rises in pitch and the triangular modulation speeds up as you depress the pedal. This is because you've used the MULTIPLE to route the pedal voltage both to the MIXER (where it is combined with the LFO triangular wave prior to being routed to your VCTG) and through an ATTENUATOR to the LFO pedal input, where it varies the speed of the triangular wave. Vary the setting of each of the knobs in the MIXER, the ATTENUATOR, and the LFO to see what effect it has on the pitch of your VCTG.

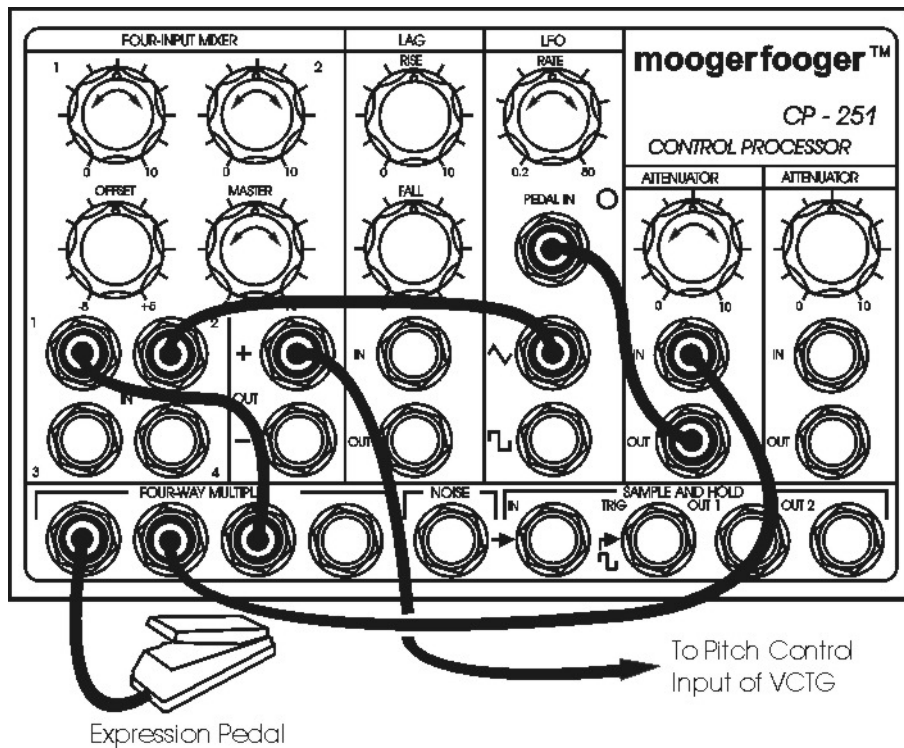

Figure 8 - Setup for trying out the Four Way Multiple.

## NOISE SOURCE

The NOISE SOURCE has a single output jack. It delivers a waveform that is completely random. When you listen to this waveform directly, you will hear a steady pitchless "white noise" sound. When you apply the waveform as a control voltage, you will hear the resultant sound become rough and "static-y".

Temporarily connect the NOISE jack directly to the input of your audio monitor. Note the distinctive "white noise" quality of the waveform. (NOTE: You can use this waveform as the audio input of an effects processor such as a moogerfooger MF101 Lowpass Filter.)

- Connect patch cords as follows:

a) from the NOISE jack to an ATTENUATOR IN jack,

b) from the ATTENUATOR OUT jack to your VCTG pitch control input.

Note that the pitch becomes rough and jagged. The amount of roughness is determined by the setting of the ATTENUATOR knob.

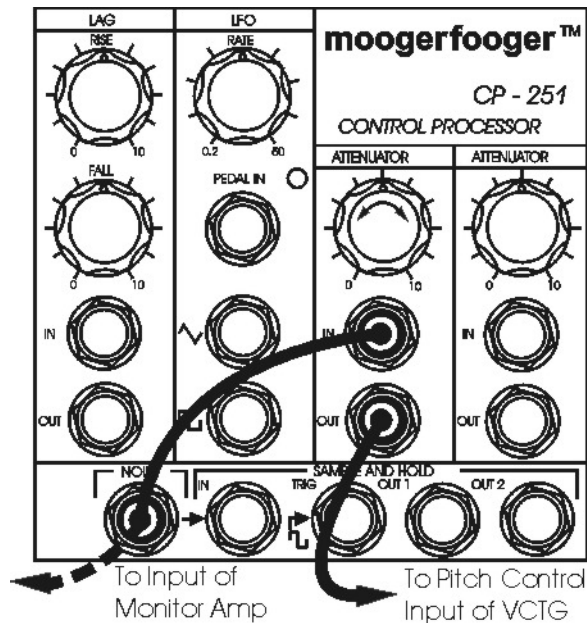

Figure 9 - Setup for trying out the Noise Source

## SAMPLE AND HOLD

The SAMPLE AND HOLD module has two inputs and two outputs. The two inputs are labeled IN and TRIG. Whenever the TRIG signal crosses a preset threshold, the voltage at the IN jack is sampled, and is held until the next time the TRIG signal crosses the threshold. The sampled voltage appears at the OUT 1 jack. In addition, the OUT 1 signal is fed through a special lowpass filter which smooths the signal out and then delivers it to the OUT 2 jack. The cutoff frequency of the special lowpass filter is directly related to

the LFO rate, so turning the LFO RATE knob affects how smooth the OUT 2 waveform is.

When no patch cord is plugged into the IN jack, the NOISE waveform is bridged to this jack. When no patch cord is plugged into the TRIG jack, the LFO square waveform is bridged to this jack.

- Connect patch cords as follows:

a) from OUT 1 to an ATTENUATOR IN jack,

b) from the ATTENUATOR OUT jack to your VCTG pitch control input.

Note that the pitch is changing in random steps at the LFO rate. Vary the setting of the LFO RATE and ATTENUATOR knobs to vary the speed and amplitude of the control waveform.

Plug your expression pedal into the IN jack. Move the pedal back and forth. Note that the setting of the expression pedal, rather than the NOISE waveform, is now being sampled and held at the LFO rate.

Remove your expression pedal from the IN jack and plug it into the TRIG jack. Move the pedal back and forth. Note that the NOISE waveform is now being sampled each time you push the pedal back, rather than at the LFO rate.

Remove the expression pedal from the TRIG jack. Remove the patch cord from the OUT 1 jack and then insert it into the OUT 2 jack. Note that the resulting signal is a smoothed version of OUT 1. The rate at which the waveform changes can be varied, from extremely slow to extremely fast, by changing the setting of the LFO RATE knob.

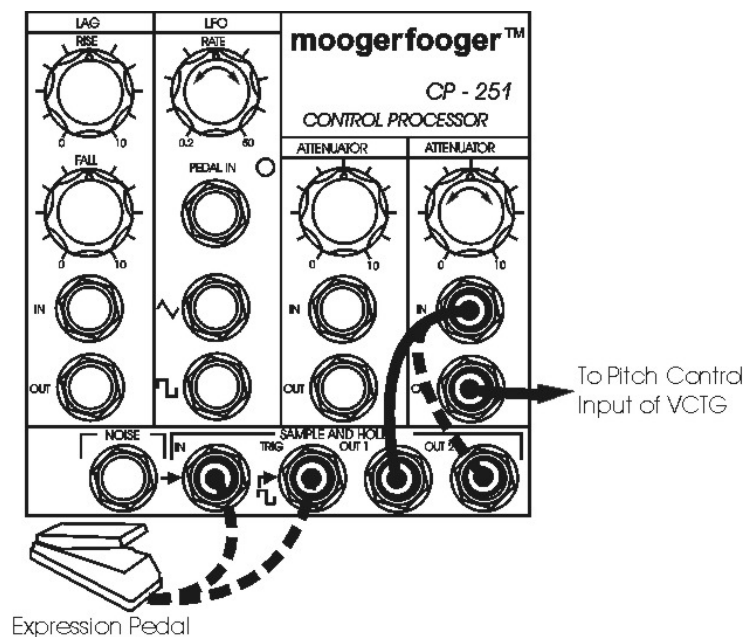

Figure 10 - Setup for trying out the Sample And Hold Module.

## USING THE CP-251 WITH OTHER MOOGERFOOGER MODULES

The following examples show a few ways that you can use your CP251 with other moogerfooger modules. With each example that you try, be sure to experiment with the settings of all the knobs that you are using. Understand what each knob controls, and what function each patch cord performs. Try out your own variations. You will be delighted at the range of effects that you will discover.

### Filter Sample and Hold Effects with the MF101 Lowpass Filter

Refer to Figure 11 for the following examples. For all variations, connect your instrument to the MF101 AUDIO IN jack and your monitor amplifier to the MF101 AUDIO OUT jack.

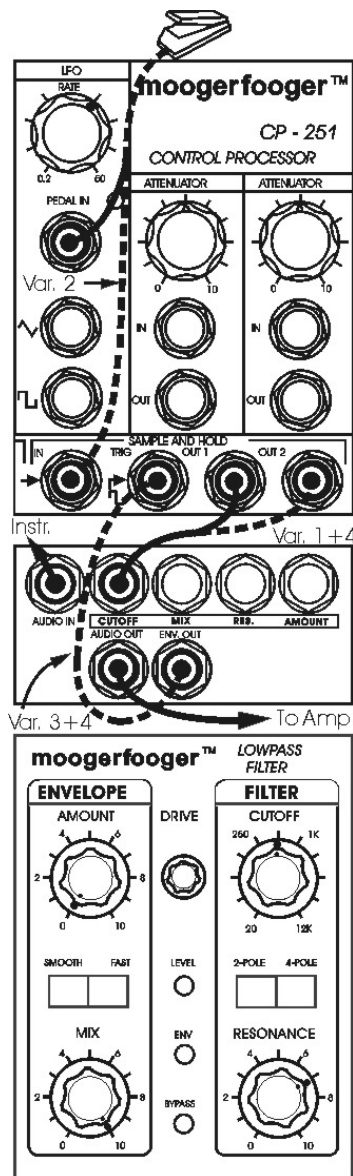

Figure 11 - Setup for Filter Sample and Hold examples

## **BASIC SETUP: RANDOM STEP FILTER**

- Connect patch cords as follows:

a) Expression Pedal to CP251 LFO PEDAL IN jack.

b) CP251 S+H OUTPUT 1 jack to MF101 CUTOFF jack.

- Set knobs as follows:

a) MF101: AMOUNT "0"; MIX "10"; CUTOFF midposition; RESONANCE "7".

b) CP251 LFO RATE at about 10 Hz (1 o'clock).

Play sustained tones through the MF101. (Brighter tones yield more audible filter effects.) Note the random filter effect. Turning up the resonance to filter self-oscillation adds random stepped tones to the signal. Turn the LFO RATE down and use the expression pedal to control the speed of the stepping.

### ***Variation 1: Random Continuous Modulation of Filter***

Instead of S+H OUT 1, patch S+H OUT 2 to the MF101 CUTOFF jack. The filter cutoff frequency is now modulated smoothly but randomly.

### ***Variation 2: "Footsteps"***

Same as basic setup, except connect the expression pedal to the S+H IN jack. Expression pedal sweeps filter cutoff, but in steps that are in time with the CP251 LFO. Fast, spastic pedal sweeps yield random-like modulation; slow sweeps generate "staircase" modulation.

### ***Variation 3: Note-triggered Random Step Filter***

- Connect MF101 ENV OUT jack to CP251 S+H TRIG jack

Other connections and settings are the same as for the Basic Setup, except be sure that MF101 Envelope Speed switch is on SMOOTH, and the DRIVE control is turned up so the ENV LED lights up bright red every time you play a note. Play a staccato line. The filter cutoff will change after every note that you play, so each note will have a different tone color.

### ***Variation 4: Note-Triggered Gliding Step Filter***

- Connections are the same as Variation 3 above, except CP251 S+H OUT 2 now goes to MF101 CUTOFF.

- Settings are the same as the Basic Setup, except CP251 LFO RATE is set to 3 o'clock (about 22 Hz).



Play a staccato line. The filter cutoff will change after every note that you play, so each note has a different tone color. However, the cutoff glides from one frequency to the next because of the smoothing action that is associated with S+H OUT 2. Note that the LFO RATE sets the speed of the glide.

## **LFO Modulation of the MF101 Lowpass Filter**

### ***BASIC SETUP: TRIANGULAR MODULATION OF THE FILTER***

- Connect patch cords as follows:

a) LFO Triangular Out jack to ATTENUATOR IN jack,

b) ATTENUATOR OUT jack to MF101 CUTOFF,

c) Expression pedal to LFO PEDAL IN jack.

- Set knobs as follows:

a) CP251 LFO RATE to 0.2 Hz; ATTENUATOR to 5,

b) MF101: AMOUNT "0"; MIX "10"; CUTOFF mid-position; RESONANCE "7" .

This patch features triangle wave modulation of the MF101 filter. The attenuator controls the amount of up and down sweep, the expression pedal and LFO RATE knob control the speed of the modulation, and the MF101 CUTOFF knob sets the center of the modulation range.

### ***Variation 1: Square Wave Modulation***

Setup is same as above, except the LFO's Square Wave output is used instead of the Triangular Wave output. Note the difference in the effect.

### ***Variation 2: Ramp Wave modulation***

- Connect more patch cords as follows:

a) LFO Square Wave to LAG IN jack,

b) LAG OUT jack to ATTENUATOR IN jack.

- Set LAG knobs as follows:

a) RISE to "0"

b) FALL to "7"

Using either the expression pedal or the RATE knob, adjust the LFO rate to 2-6 Hz. Note

that the rise of the modulation waveform is much faster than the falling part. Now change to RISE knob to "7" and the FALL knob to "0" to produce a modulation waveform in which the falling part is much faster than the rising part.

Experiment with the LAG knobs, the ATTENUATOR knob, and the MF101 CUTOFF and RESONANCE knobs to explore the different effects that can be achieved by "playing" the knobs that affect the modulation waveform.

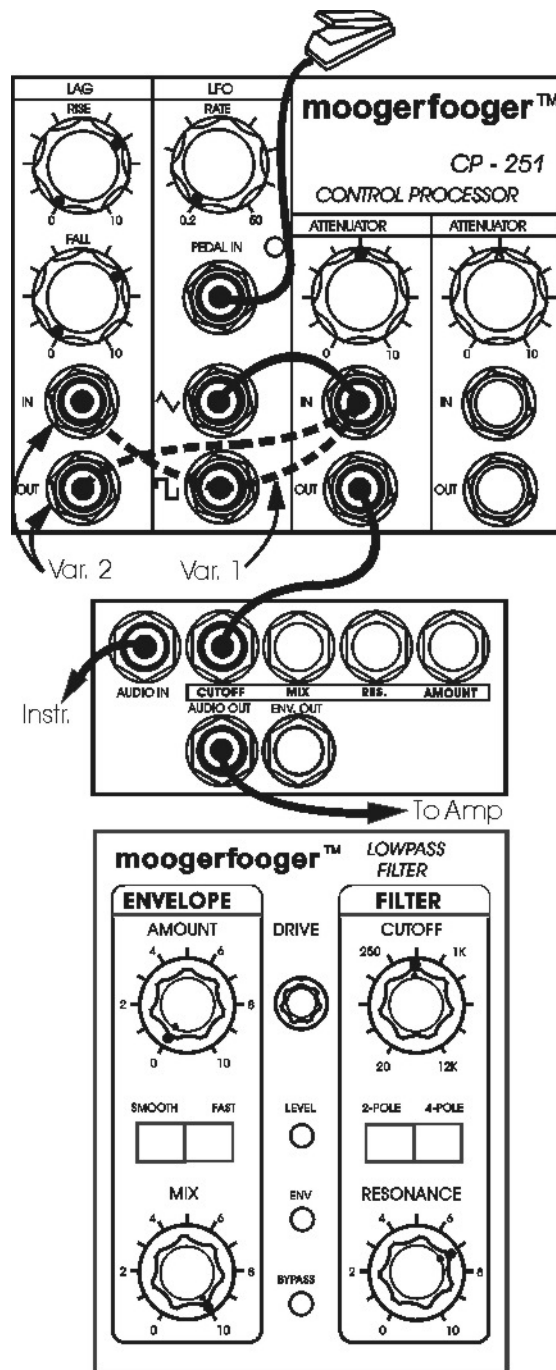

Figure 12 - Setup for LFO modulation examples.

**Talking Bass” (A patch that uses both an MF101 Lowpass Filter and an MF102 Ring Modulator)**

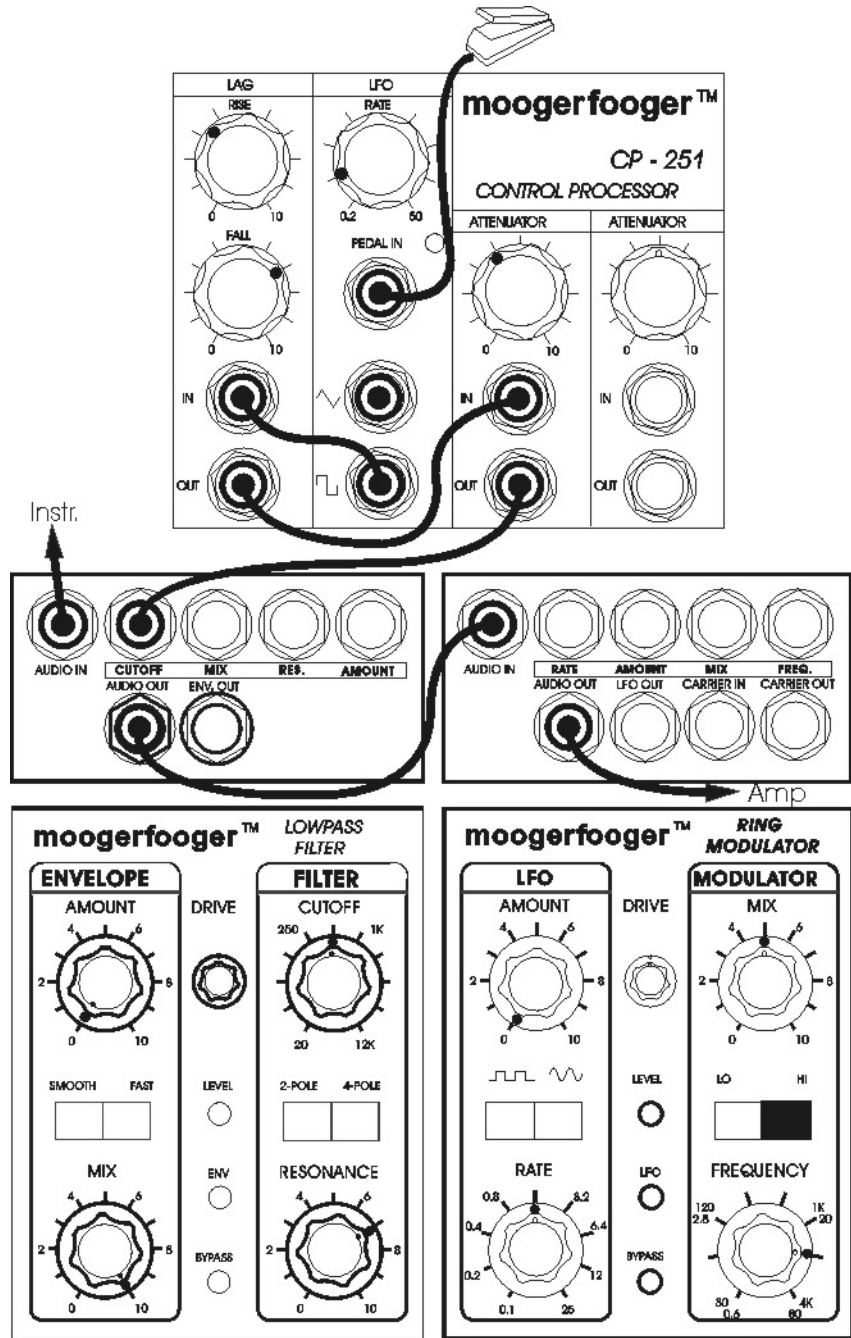

Figure 13 - Setup for "Talking Bass".

- Connect patch cords as follows:
- a) MF101 AUDIO OUT to MF102 AUDIO IN,

- b) Output of your instrument to MF101 AUDIO IN,
- c) MF102 AUDIO OUT to input of your monitor amp,
- d) Expression Pedal to CP251 LFO PEDAL IN jack,
- e) CP251 LFO Square Wave out jack to LAG IN jack,
- f) CP251 LAG OUT jack to ATTENUATOR IN jack,
- g) ATTENUATOR OUT jack to MF101 CUTOFF jack.

- Set knobs as follows:

- a) CP251: LFO RATE low (about 9 o'clock); LAG RISE " 4" ; LAG FALL " 7" , ATTENUATOR " 4" ,
- b) MF101: AMOUNT " 0" ; MIX " 10" ; CUTOFF mid-position; RESONANCE " 7"
- c) MF102: AMOUNT " 0" , MIX " 5" ; FREQUENCY switch " HI" ; FREQUENCY " 2 kHz" (about 3 o'clock ).

Play a bass note. You will hear a voice-like timbre. Changing the CP251 LFO RATE and/or the expression pedal setting changes the speed at which the voice says "yeow" . Experiment with the settings of the LAG RISE and FALL, the MF101 CUTOFF and RESONANCE, and the MF102 FREQUENCY and MIX knobs.

## Dual LFO Modulation

This setup uses your CP251 and an MF102 to illustrate how two LFO waveforms can be combined to form a dual LFO modulation waveform. One of the LFO waveforms comes from the CP251's LFO module, while the other LFO waveform comes from the MF102's LFO OUT jack. Initially, we'll listen to the MF102's CARRIER OUT signal to hear the modulation.

- Connect the following patch cords:

- a) CP251 LFO Triangular Output jack to MIXER IN 2 jack,
- b) MF102 LFO OUT jack to CP251 MIXER IN 1 jack,
- c) MIXER " +" OUT jack to MF102 FREQ jack,
- d) MF102 CARRIER OUT jack to input of monitor amplifier.

- Set knobs as follows:

- a) CP251: All MIXER knobs to midposition; LFO RATE to 11 o'clock,
- b) MF102: LFO RATE to " 0.1" ; AMOUNT to " 0" ; FREQUENCY to 11 o'clock.

Turn down the monitor amp to a comfortable level. You'll hear frequency modulation of the carrier oscillator by the two LFO waveforms. MIXER IN 1 and IN 2 determine the strengths of the individual LFO waveforms, MASTER sets the overall strength of the dual LFO waveform, and OFFSET raises and lowers the voltage at the center of the dual LFO waveform, thereby raising and lowering the pitch of the carrier oscillator.

Now disconnect the monitor amp from the CARRIER OUT jack and connect it to the MF102 AUDIO OUT jack. Connect your instrument to the MF102's AUDIO IN. Set MIX to "10" and AMOUNT to "0". Listen to the effect of the dual LFO modulation on your instrument's ring-modulated signal.

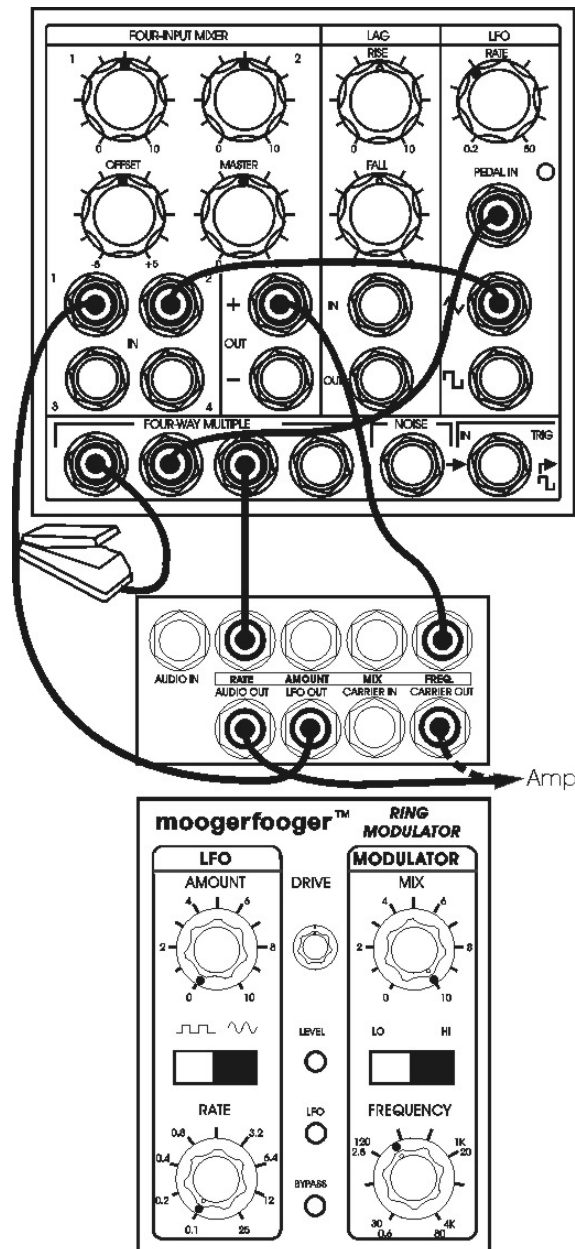

Figure 14 - Setup for dual LFO modulation.

## “Phaser-rhythm”

This patch uses the voltage steps at the CP251 S+H OUT 1 jack as the audio input to an MF103 12-Stage Phaser. The sharp voltage rise at the beginning of each step creates a wideband click. This causes the phaser to “ring” simultaneously at several frequencies, thereby converting the click into a distinctive percussive tone.

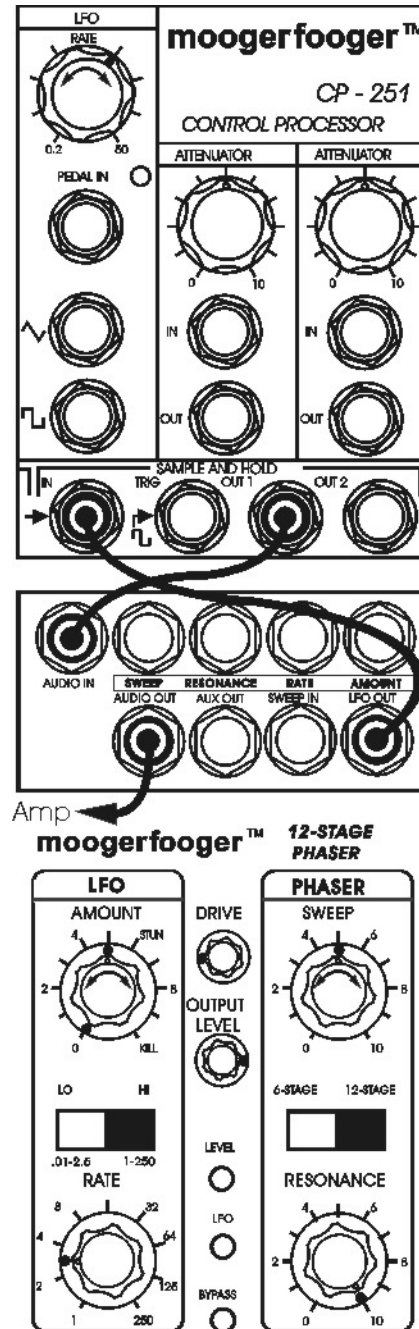

Figure 15 - Setup for "Phaser-rhythm".

- Connect patch cords as follows:

a) MF103 LFO OUT jack to CP251 S+H IN jack,

b) CP251 S+H OUT 1 jack to MF103 AUDIO IN jack,

c) MF103 AUDIO OUT jack to Monitor Amp.

• Set Knobs and Switches as follows:

a) CP251: LFO RATE to 1 o'clock,

b) MF103: AMOUNT "0"; RATE SWITCH "HI"; RATE "3" (8:30); DRIVE 9 o'clock (so LEVEL light blinks green and yellow); OUTPUT LEVEL 3 o'clock; SWEEP midposition ("5"), MODE switch on "12-STAGE"; RESONANCE "10".

You will hear a repeating series of pitched pulses. Each step at the S+H OUT 1 jack creates one pulse. The pulses vary in loudness. This is because the OUT 1 steps are of differing heights, which, in turn, is because the MF103 LFO triangular wave is being sampled, and this waveform is not in exact synchronism with the CP251 LFO. In fact, if you vary the setting of the MF103 RATE knob, you will hear the loudness pattern of the pulses change. For now, leave the MF103 RATE knob at "3".

Next, vary the setting of the SWEEP knob. Note that this changes the pitch of the pulses. Return the SWEEP knob to "5".

Finally, Turn the MF103 AMOUNT knob to "5". Now the MF103's LFO is being sampled and is modulating the phaser sweep, so each pulse has a different pitch as well as a different amplitude. Experiment with all four of the MF103 performance parameter knobs (the larger knobs). Note that the RATE knob determines the syncopation of the pattern, the AMOUNT knob determines the depth of the pattern, the SWEEP knob determines the pitch range of the pulses, and the RESONANCE knob determines the quality of the pulses.

## **TECHNICAL INFORMATION**

This section contains technically-oriented information which is somewhat more detailed than the previous sections. Some users will find this information helpful in devising advanced uses for the CP251. The information is arranged according to the CP251 module to which it applies.

### **MIXER**

The nominal input resistance of inputs #1 and #2 is 50KW. The nominal input resistance of inputs #3 and #4 is 100KW. The nominal output (source) resistance of each of the outputs is 500 W.

The maximum input-to-output gain is unity. The maximum nominal output voltage range is  $\pm 5$  volts. The - output is the negative of the + output.

The frequency response of the mixer is DC to 50kHz.

The OFFSET knob can be considered a fifth input with a voltage range of  $\pm 5$  volts.

### **LAG**

The nominal input resistance is 10 megW. The nominal output (source) resistance is 500 W.

The nominal input-to-output voltage gain is unity.

Time constants of rising and falling waveform edges are determined by the RISE and FALL knobs. Nominal time constants are 1 millisecond, 100 milliseconds, and 1 second when the knobs are fully counterclockwise, in midposition, and fully clockwise, respectively.

### **LFO**

The nominal input resistance of the PEDAL IN jack is 120 kW. The nominal voltage-to-frequency characteristic of this input is: a one-volt increase doubles the frequency.

The operating frequency of the LFO is determined by the sum of the voltage at the PEDAL IN jack and the voltage coming from the RATE control. An expression pedal such as the moogerfooger EP-1 has a nominal range of 0 to +5 volts when plugged into the PEDAL IN jack. You should use the RATE control to set the minimum desired LFO frequency, and adjust the voltage range of the pedal or externally-applied control voltage to get the desired range of LFO frequencies.

The LFO frequency can go both lower than the minimum calibration on the RATE control (by applying a negative control voltage), and higher than the maximum calibration on the RATE control (by applying the appropriate positive control voltage). The minimum frequency is less than 0.03 Hz (one cycle every 33 seconds), and the



maximum frequency is greater than 100 Hz.

The nominal peak voltage of the triangular and square waveforms is  $\pm 2.5$  volts . The nominal output (source) resistance of each of these outputs is 500 W.

## **ATTENUATORS**

Each of the attenuators is a 50KW, linear taper potentiometer. The IN jack is connected across the potentiometer element, while the OUT jack is connected from the counterclockwise end of the element, to the potentiometer's wiper arm.

## **FOUR WAY MULTIPLE**

The tip terminals of all four jacks are connected together. The sleeve terminals of all four jacks are connected together.

## **NOISE**

Nominal peak output voltage is  $\pm 0.6$  volts. Nominal RMS output voltage is 0.17 volts (-13 dBm).

Nominal output (source) resistance is 500 W.

Frequency band of the noise waveform is 500 Hz - 3,500 Hz.

## **SAMPLE AND HOLD**

Nominal input resistance at the IN jack is 10KW. Nominal voltage range which this input will sample is  $\pm 3$  volts.

Nominal input resistance at the TRIG jack is 10KW. Triggering occurs when the voltage at the TRIG jack descends through the +1 volt nominal trigger threshold.

Nominal input-to-output gain is unity. If the noise source is sampled, then the output waveform appearing at OUT 1 is about  $\pm 2$  volts peak-to-peak. In between samples, the maximum output voltage drift rate is no more than 0.1 millivolt per second.

The nominal input-to-output gain from the IN jack to the OUT 2 jack is X2. A two-pole direct-coupled lowpass filter is placed between OUT 1 and OUT 2. The cutoff frequency of this filter is proportional to the LFO frequency. Thus it is possible to voltage-control this filter, and to set its cutoff frequency to as low as a small fraction of 1 Hz.

## **RED JACKS**

The CP251 contains a total of eight jacks with red nuts. The Ring terminal of each of these jacks is supplied with +5.6 volts at a nominal maximum current of 600 microamperes. This is more than adequate to supply operating current to normal expression pedals. Electronically-inclined users are encouraged to experiment with

novel control devices that are powered by the CP251's red jacks (as well as by any of the pedal/control jacks on moogerfooger MF-Series products).

Plugging a conventional two-circuit phone plug (tip-sleeve) into any of the red jacks will not adversely affect the operation of any part of the CP251. Such a phone plug will short that jack's pedal supply to ground, causing a current of about 2 milliamperes to flow through the plug's barrel.

## **POWER SOURCE**

The CP251 is designed to operate on a conventional +9 volt power adapter with a current rating of 200 milliamperes or higher. If you wish to use a special power supply, it should deliver no less than +9.0 volts and no more than +12.0 volts, and have a current rating of no less than 100 milliamperes.

## **SELECTING PATCH CORDS FOR USE WITH moogerfooger MF-SERIES MODULES**

Your CP251 will work properly with either two-conductor (Tip-Sleeve) or three-conductor (Tip-Ring-Sleeve) patch cords. If you use two-conductor patch cords, then, as explained above, plugs inserted into the red jacks will simply short the pedal supply currents to ground, with no adverse effects whatsoever to the operation of the CP251.

When used with MF-Series devices however, two conductor patch cords will short out the pedal supply current that is available at all pedal/control input jacks. Thus, if you plug a tip-sleeve phone plug into one of the pedal/control input jacks of an MF-Series device, then none of the pedal/control jacks on that device will be able to supply power to an expression pedal. This is explained in the user's manual that accompanied your MF-Series device.

If you wish to use your CP251 Control Processor with an MF-Series device and you wish to be able to plug one or more expression pedals into the pedal/control jacks of the device, then your best bet is to purchase or make a set of patch cords with Tip-Ring-Sleeve phone plugs, but do not connect the Ring terminals to anything. Alternately, you can acquire a set of three-conductor patch cords in which the Ring terminals of the two plugs of each patch cord are connected together. Such cords will not short out the pedal supply currents that are available at the MF-Series pedal/control jacks when the other ends are plugged into most two-conductor phone jacks.

## **GENERAL CONSIDERATIONS**

In general, there is little danger that plugging a patch cord into the wrong pair of jacks will damage the CP251. However, under certain conditions, shorting an output to ground or connecting two outputs together may affect the proper operation of the CP251 circuitry. Two good rules to remember are:

1. You can connect one output to as many inputs as you want, but
2. You should never connect more than one output together. Use a mixer to combine two or more signals.

## **LIMITED WARRANTY**

Moog Music warrants that its products will be free from defects in materials or workmanship, and shall conform to specifications current at the time of shipment, for a period of one year from date of purchase. During the one-year period, any defective products will be repaired or replaced, at Moog Music's option, on a return-to-factory basis. This Warranty covers defects that Moog Music determines are no fault of the user.

## **RETURNING YOUR CP-251 FOR REPLACEMENT/REPAIR**

You must obtain prior approval and an RMA number from Moog Music before returning any product to us. (Call 828-251-0090 or email [techsupport@moogmusic.com](mailto:techsupport@moogmusic.com) to obtain approval.) Wrap your CP251 carefully and pack it with the power adaptor in its original carton. The warranty will not be honored if the product is not properly packed. Then send it to Moog Music (UPS is recommended) with transportation and insurance charges paid.

A reasonable cost for service and for materials and return freight will be charged to replace materials defective through the fault of the user, or for which the one year warranty period has expired.

Transportation and insurance charges from Moog Music to your United States address, of products repaired or replaced under warranty, will be paid by Moog Music.

MOOG MUSIC, Inc. 554C RIVERSIDE DRIVE ASHEVILLE, NC 28801  
Phone (828) 251 0090 FAX (828) 254 6233 EMAIL: [info@moogmusic.com](mailto:info@moogmusic.com) or  
[techsupport@moogmusic.com](mailto:techsupport@moogmusic.com)  
WEB SITE: <http://www.moogmusic.com>  
Entire contents © 2000,2003 by Moog Music, Inc.