

# ACP88

Eight Channel  
Compressor/Limiter/Gate

User's Manual

**Version 1.2**

# ACP88

E I G H T   C H A N N E L  
C O M P R E S S O R / L I M I T E R / G A T E

USERSMANUAL

Version 1.2

Copyright 1998,2000,2001 PreSonus Audio Electronics, Incorporated.  
All rights reserved.

## W A R R A N T Y

### PreSonus Limited Warranty

PreSonus Audio Electronics Inc. warrants this product to be free of defects in material and workmanship for a period of one year from the date of original retail purchase. This warranty is enforceable only by the original retail purchaser. To be protected by this warranty, the purchaser must complete and return the enclosed warranty card within 14 days of purchase. During the warranty period PreSonus shall, at its sole and absolute option, either repair or replace, free of charge, any product that proves to be defective on inspection by PreSonus or its **authorized service representative**. To obtain warranty service, the purchaser must first call or write PreSonus at the address and telephone number printed below to obtain a Return Authorization Number and instructions of where to return the unit for service. All inquiries must be accompanied by a description of the problem. All authorized returns must be sent to the PreSonus repair facility postage prepaid, insured and properly packaged. PreSonus reserves the right to update any unit returned for repair. PreSonus reserves the right to change or improve the design of the product at any time without prior notice. This warranty does not cover claims for damage due to abuse, neglect, alteration or attempted repair by unauthorized personnel, and is limited to failures arising during normal use that are due to defects in material or workmanship in the product. Any implied warranties, including implied warranties of merchantability and fitness for a particular purpose, are limited in duration to the length of this limited warranty. Some states do not allow limitations on how long an implied warranty lasts, so the above limitation may not apply to you. In no event will PreSonus be liable for incidental, consequential or other damages resulting from the breach of any express or implied warranty, including, among other things, damage to property, damage based on inconvenience or on loss of use of the product, and, to the extent permitted by law, damages for personal injury. Some states do not allow the exclusion of limitation of incidental or consequential damages, so the above limitation or exclusion may not apply to you. This warranty gives you specific legal rights, and you may also have other rights, which vary from state to state. This warranty only applies to products sold and used in the United States of America. For warranty information in all other countries please refer to your local distributor.

#### Limited Warranty Outside of The U.S.

PreSonus Audio Electronics products are warranted only in the country where purchased, through the authorized PreSonus distributor in that country, against defects in material and workmanship. The specific period of this limited warranty shall be that which is described to the original retail purchaser by the authorized PreSonus dealer or distributor at the time of purchase. PreSonus does not, however, warrant its products against any and all defects: 1) arising Out of materials or workmanship not provided or furnished by PreSonus, or 2) resulting from abnormal use of the product or use in violation of instructions, or 3) in products repaired or serviced by other than authorized PreSonus repair facilities, or 4) in products with removed or defaced serial numbers, or 5) in components or parts or products expressly warranted by another manufacturer. PreSonus agrees, through the applicable authorized distributor, to repair or replace defects covered by this limited warranty with parts or products of original or improved design, at its option in each respect, if the defective product is shipped prior to the end of the warranty period to the designated authorized PreSonus warranty repair facility in the country where purchased, or to the PreSonus factory in the U.S., in the original packaging or a replacement supplied by PreSonus, with all transportation cost and full insurance paid each way by the purchaser or owner. All remedies and the measure of damages are limited to the above services. It is possible that economic loss or injury to person or property may result from the failure of the product; However, even if PreSonus has been advised of this possibility, this limited warranty does not cover any such consequential or incidental damages. Some states or countries do not allow the limitations or exclusion of incidental or consequential damages, so the above limitation may not apply to you. Any and all warranties, express or implied, arising by law, course of dealing, course of performance, usage of trade, or otherwise, including but not limited to implied warranties of merchantability and fitness for a particular purpose, are limited to a period of two years from either the date of original retail purchase or, in the event no proof of purchase date is available, the date of manufacture. Some states or countries do not allow limitations on how long an implied warranty last, so the above limitations may not apply to you. This limited warranty gives you specific legal rights, and you may also have other rights which vary from state to state, country to country.

PreSonus Audio Electronics, Inc.  
7257 Florida Blvd.  
Baton Rouge, LA 70806  
(225) 216-7887

Copyright 1998, 2000, 2001 PreSonus Audio Electronics, Incorporated. All rights reserved.

---

## TABLE OF CONTENTS

---

- 1 Overview
    - 1.1 Introduction
    - 1.2 Features
  - 2 Controls & Connections
    - 2.1 Front Panel Basic Layout
    - 2.2 Compressor Controls
    - 2.3 Gate Controls
    - 2.4 Gain
    - 2.5 Bypass & Link
    - 2.6 Patch Panel
    - 2.7 Power
  - 3 Basic Setup and Applications
    - 3.1 Some Basic Patching
    - 3.2 Basic Applications
  - 4 Technical
    - 4.1 Specifications
    - 4.2 Block Diagram
-

## OVERVIEW

---

### 1.1 INTRODUCTION

Thank you for purchasing the PreSonus ACP-88 multi-channel dynamics processor. Your processor was designed using state of the art components to deliver crystal clear compression and noise gating for an infinite period of time. We believe the ACP-88 to be an exceptional sounding unit and an exceptional value. Feel free to contact us at 1-800-750-0323 anytime for any reason. We value your suggestions and your comments. PreSonus Audio Electronics is committed to constant product improvement and feel the best way to accomplish this task is by listening to the *experts* on our gear, our valued customers. We appreciate the support you have shown us through the purchase of our products.

Please pay close attention to how you connect your ACP-88 to your system. Improper grounding is the most common cause of noise problems found in studio or live sound systems. We urge you to scan this manual before hooking up your ACP-88 to become familiar with its features and various applications.

Good luck and enjoy your ACP-88!

### 1.2 FEATURES

The following is a summary of your ACP-88's features:

- ? **Eight Compressors/Limiters.** Each channel of your ACP-88 contains an audio **Compressor** that can also be setup as a **Limitter** by varying the ratio of compression. You have broad control over **Threshold, Ratio, Attack** and **Release** for each processor. You can select between **Auto** or **Manual Attack** and **Release** curves and **Hard** or **Soft Knee** compression types (refer to the application section of this manual for a quick tutorial on compression/limiting). The **Compressor** will prove to be very useful in many situations such as recording instruments or vocals that vary in loudness, or setting it up as a **limiting** device before your digital recorder to prevent distorting your digital recorder's inputs. Live sound system processing is another great application where your ACP-88 can really take control.
  
- ? **Eight Dynamic Noise Gates.** Each channel of your ACP-88 has a separate dynamic noise gate that can be used to Gate an entire

## OVERVIEW

---

drum kit, clean up a noisy tape machine, isolate an instrument or separate a vocal from background noise. Each noise **Gate** provides control over **Attack**, **Threshold**, **Release** and **Gate close Range**. The Gate close range can be useful in creating a more natural sounding blend or mix when gating many instruments at once.

- ? **Comprehensive Channel Linking.** Using the **Link** function allows you to combine any combination of ACP-88 channels effectively forming a *subgroup*. When linked, all processors follow the setting of the *Master* processor which is *always* the processor furthest to the **Left** in a **Link** group. For example, you could **Link** together channels **7** and **8** to form a **Stereo pair**, channels **3**, **4** and **5** to form a **subgroup** of processors, while channels **1**, **2** and **6** remain available for *independent* applications such as **compression**, **limiting**, or **gating** as the situation dictates.
- ? **Separate Bypass and Gain for Every Channel.** Each Channel has a separate **Bypass** for auditioning a signal '*before and after*' processing with the compressor, limiter, or the **Gate** and a **Gain** control to make up any loss in signal level resulting from the amount of compression being applied.
- ? **Compressor Sidechain Jack on Every Channel.** Each channel of your ACP-88 was designed with a special jack for *spectral processing*, *compression keying* and *ducking* applications. **Sidechaining** is useful for removing annoying sibilance from vocal tracks (*de-essing*) or automatically ducking tracks behind a narrator for 'auto mixing' a service, broadcast or performance. When multiple channels are **Linked** together, the **Send** of the **Sidechain** jack of the **Master** channel contains a mix of all the channels in the **Link**: a very cool feature allowing control over multiple channels of processing with one **Sidechain send/return**. (See the section on **Sidechaining** for application notes.)

## OVERVIEW

---

- ? **Separate Gate Sidechain/keying Jacks for Each Channel.** Your ACP-88 also includes a separate jack on each channel for **Gate sidechain/Keying**. This is useful for *syncing* an external sound to a snare track, for example, or putting equalizers or filters before the **Gate key** to enable **Gating** only the lower frequency of a kick drum, etc.
  
- ? **Balanced/Unbalanced Inputs and Outputs.** Your Acp-88 accepts either balanced or unbalanced inputs and outputs using tip-ring-sleeve (TRS) connectors.
  
- ? **+ 4dBu or – 10dBV.** The internal operating level of your ACP-88 can be switched between **+4dBu** (pro levels) to **–10dBV** (line levels), making it possible to use in virtually any application.

## OVERVIEW

---

### **To Get Help...**

Call Us: 1-800-750-0323, 9 AM to 5 PM, CST

Visit our World Wide Web Site: <http://www.presonus.com>

Email Us: [presonus@presonus.com](mailto:presonus@presonus.com)



## CONTROLS & CONNECTIONS

---

### 2.1 Front Panel Basic Layout

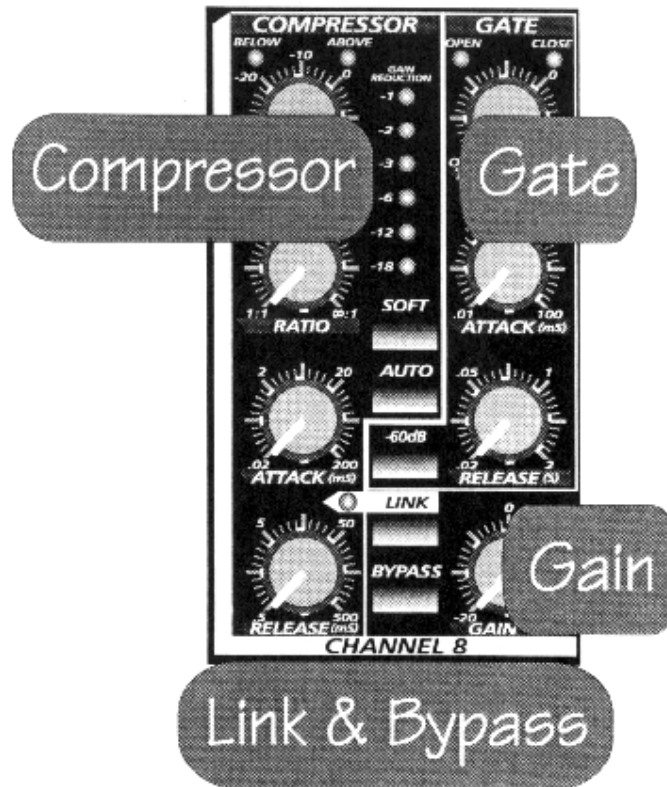

Notice that the front panel is divided into eight identical sections.

These are the eight signal processing chains of the ACP-88.

Each channel contains:

- ? Compressor/Limiter
- ? Noise Gate
- ? Gain Makeup
- ? Link & Bypass Control

## CONTROLS & CONNECTIONS

---

### 2.2 Compressor Controls

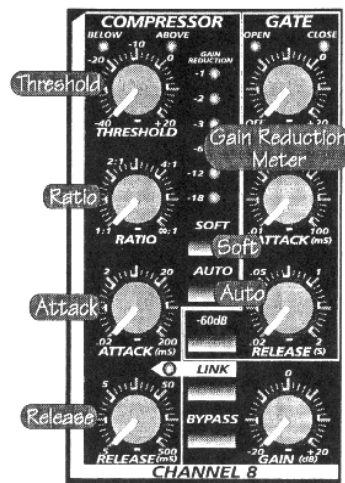

#### Threshold

The Compressor **Threshold** sets the level at which compression begins. The **below** and **above** LED's over the **Threshold** knob indicate whether the input signal is below or above the **Threshold** setting. When the signal is above the Threshold setting, it becomes 'eligible' for compression. Basically, as you turn the **Threshold** knob *counter-clockwise*, the input signal is compressed. (If you have a ratio setting of greater than 1:1.)

#### Ratio

**Ratio** sets the compression slope. This is defined as the output level versus the input level. For example, if you have the **Ratio** set to **2:1**, any signal level above the Threshold setting will be compressed at a compression **ratio** of **2:1**. This simply means that for every **1dB** of level increase into the compressor, the output will only increase  $\frac{1}{2}$  **dB**, thus producing a compression **Gain reduction** of **0.5 db**. As you increase the **Ratio**, the compressor gradually becomes a *limiter*. A limiter is defined as a processor that **limits** the level of signal to the setting of the **Threshold**. For example, if you have the

## CONTROLS & CONNECTIONS

---

**Threshold** knob set at **0 dB**, and the **Ratio** turned *fully clockwise*, the **Compressor** becomes a  **Limiter at 0 dB**. This means the signal will be *limited* to an output of **0 dB** regardless of the input signal.

### Attack

**Attack** sets the speed at which the compressor 'acts' on the *input* signal. A **slow attack** time (*fully clockwise*) allows the beginning envelope of a signal (commonly referred to as the initial *transient*) to pass through the compressor uncompressed, whereas a **fast attack** time (*fully counterclockwise*) *immediately* subjects the signal to the **Ratio** and **Threshold** settings of the compressor.



The **Attack** control is only active when the **Auto** button is not pushed in. When the **Auto** button is pushed in, the compressor automatically determines the appropriate **Attack** time for compression.

### Release

**Release** sets the *length* of time the compressor takes to return the **Gain reduction** back to zero (*no gain reduction*). Very **short Release** times can produce a very choppy or 'jittery' sound, especially in low frequency instruments such as bass guitar. Very **long Release** times can result in an overly compressed signal, sometimes referred to as '*squashing*' the sound. All ranges of **Release** can be useful at different times however and you should experiment to become familiar with the different sound possibilities. (Refer to the **applications** section of this manual for some ideas.)



The **Release** control is only active when the **Auto** button is not pushed in. When the **Auto** button is pushed in, the compressor automatically determines the appropriate **Release** time for compression.

## CONTROLS & CONNECTIONS

---

### **Soft**

The **Soft** button selects **Soft Knee** and **Hard Knee** compression curves. When this button is pushed in, **Soft knee** compression curves are used, otherwise **hard knee** compression curves are used. With **Hard knee** compression, the gain reduction applied to the signal occurs *as soon as* the signal *exceeds* the level set by the threshold. With **Soft knee** compression, the onset of gain reduction occurs gradually *after* the signal has *exceeded* the **Threshold**, producing a more musical response (to some folks).

### **Auto**

When pushed in, the **Auto** button places the compressor in automatic attack and release mode. The **Attack** and **Release** knobs become inoperative and a pre-programmed **Attack** and **Release** curve is used.

---

## CONTROLS & CONNECTIONS

---

### 2.3 Gate Controls



#### Attack

The **Gate attack** control sets the speed at which the gate *opens* to allow signal to pass through it. This control is variable from **10** microseconds to **100** milliseconds. It is advisable to use slower **Attack** times when gating vocals or quieter instruments to avoid what is often described as gate '*clicking*'. This phenomena is not made by a mechanical device in the noise gate, but is rather, an audible manifestation of '*no signal*' to the *presence* of signal as the *gate* opens. The fastest setting is fully counter-clockwise (left) to the slowest setting all the way round to the right (clock-wise).

#### Threshold

The gate **Threshold** sets the level at which the gate *opens* as indicated by the 'OPEN' LED above the **Threshold** knob. Essentially, all signals above the **Threshold** setting are passed through unaffected, whereas

---

## CONTROLS & CONNECTIONS

---

signals *below* the **Threshold** setting are *reduced* in level by the amount set by the **Range** switch. The 'CLOSE LED above the **Threshold** knob indicates when the gate is *closed* (the signal level is below the threshold). If the **Threshold** is set fully counter-clockwise, the **Gate** is turned *off* (always open), allowing all signals to pass through unaffected.

### Release

The **Gate Release** time determines the rate at which the gate closes. This is indicated by observing the OPEN and CLOSED LED's. As the **Release** time is lengthened (clockwise), you will notice that the CLOSE LED reflects the *close* time. **Release** times should typically be set so that the natural decay of the instrument or vocal being gated is not affected. Shorter **Release** times help to clean up the noise in a signal but may cause '*chattering*' in percussive instruments. Longer release times usually eliminate '*chattering*' and should be set by listening carefully for the most natural sounding **Release** for the signal being processed.

### Range Switch

The **Gate range** is the signal level *reduction* that occurs when the gate *closes*. Therefore, if the **Range switch** is set at **15 dB**, there will be a **slight** change in the signal as it crosses the **Threshold**. If the **Range switch** is *pushed in*, the signal will be **Gated** (*reduced*) by **60 dB**. The CLOSE LED above the **Threshold** knob indicates this by changing brightness relative to the **Range** amount that has been selected. When the **Range** is set to **15 dB**, the CLOSE LED will show half illumination. When the **Range** is set to **60 dB**, the CLOSE LED will illuminate to it's brightest level at the *end* of the release time. (**REMEMBER: Release** time is set by the **Release** control.)

## CONTROLS & CONNECTIONS

---

### 2.4 Gain

#### Gain

When compressing a signal, **Gain** reduction usually results in an overall reduction of level. The **Gain** control allows you to restore the loss in level which occurs due to the amount of compression used. (like readjusting the volume.)

### 2.5 Bypass & Link

#### Bypass

Activating the **Bypass** effectively removes *all* processing being performed by your ACP-88 and returns the signal to *unity gain*. You should use **Bypass** often when setting up your ACP-88 to compare the 'before and after' results of the signal processing effecting your audio signal. **Bypass** affects both the **Gate** and the **Compressor**. When **Bypassed**, the **Link** function is interrupted for that channel and essentially breaks the link in your linking 'chain'.

#### Link

When the **Link** button is engaged (*pushed in*) the LED labeled **LINK** becomes active indicating this channel has become the *slave* of the channel to its immediate *left* (The **Link LED** is only *active* when the signal is present in the **Linked channel**). All of the controls for the **Linked** channel become *disabled* and metering occurs by way of the **Gain reduction** meter of the channel to the left (**Exception:** the LED meter of the *Slaved* channel is still useful to indicate the presence or lack of signal). Essentially, the *left* channel is still the *Master* and the channel with the **Link** button pushed **in** is the *Slave* channel in a **stereo linked pair**. If multiple **Link** buttons are pushed **in**, then the channel *farthest* to the *left* of the multiple **Linked** channels (without its link button pushed in) becomes the **Master** for the multiple **Linked** channels. In this case, all metering should be referred to the **Master** channel's meter.



**IMPORTANT:** When a channel is **Linked** (link button pushed in), all of it's controls are *inactive*. The **Link LED** is active. Also, even though the meters on the **Linked** channel are still operational

## CONTROLS & CONNECTIONS

---

(presence or lack of signal), all metering should be referred to the Master channel's meter for the Gain reduction level of the Linked channels!

### 2.6 Patch Panel (Back)

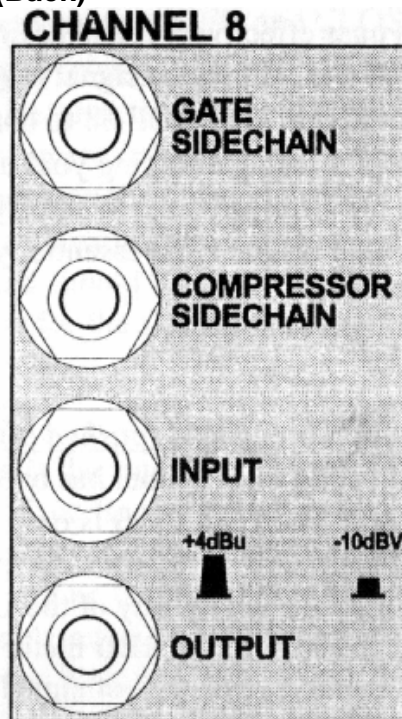

#### Input

The **Input** jack accepts balanced tip-ring-sleeve or unbalanced tip-sleeve connectors. The **Input** can handle up to **+24** dBu unbalanced or up to **+18** dBu *balanced* signal levels.



## CONTROLS & CONNECTIONS

---

### Output

The **output** jack accepts balanced tip-ring-sleeve or unbalanced tip-sleeve connectors. The **output** will deliver up to **+24** dBu in signal level, balanced or unbalanced.

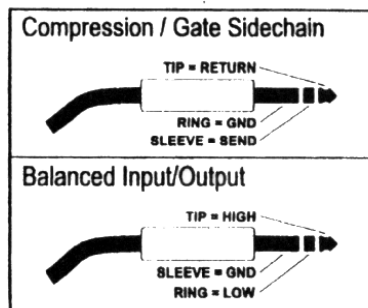

Cable Connection Diagrams

### +4/-10 Switch

This switch adjusts the internal operating level of your ACP-88 when it is connected to line level (**0 dB = -10 dBV**) gear. With this switch in the **'-10'** position, the signal is adjusted by **11.2 dB** so that it can be processed at the lower noise floor of your ACP-88's internal circuitry. The signal level is lowered on the way out to match with your line level gear's input. When the switch is in the **'+4'** position, the signal is not changed since this matches the optimum internal operating level of your ACP-88.

### Compressor Sidechain

The **Sidechain** jack on each channel interrupts the signal that the compressor is using to determine the amount of **Gain reduction** to apply. When no connector is inserted into this jack, the input signal goes directly to the compressor's control circuitry. When a connector is inserted into this jack, the signal path is broken. If you have inserted a ¼ inch tip-ring-sleeve (TRS) connector, the input signal is sent back out of the ACP-88 via the ring of the

## CONTROLS & CONNECTIONS

---

connector. This signal can then be processed by an equalizer for example to reduce sibilance (de-essing) in a vocal track. The signal is then *returned* to the unit via the **tip** of the connector. The signal *sent* via the **ring** could be that of a narrator or vocalist. In this application, the audio that you are passing through the compressor will automatically '*duck*' when the narrator speaks or vocalist sings.

### Gate Sidechain/Key Insert

The **Gate sidechain** jack accepts a *tip-ring-sleeve* connector and is used to **open** the **Gate** from either a modified version of the signal passing through the **Gate** or some other external source. For example, the **Gate** may be **Keyed** from a version of the kick drum's signal with all of the high frequencies rolled off. This set-up could be useful to stop the kick drum's gate from opening during a cymbal crash, for example.

 **NOTE:** The Key and Sidechain are in the signal path of the gate and compressor, respectively. These inserts require periodic cleaning as you would a patchbay to insure proper operation. It is not uncommon for condensation to form a film on these contact points. Failure to clean these inserts can result in a loss or degradation of signal. Should a gate or compressor fail, inserting a ¼ inch connector several times into the insert points commonly restores normal operation.

## CONTROLS & CONNECTIONS

---

### 2.7 Power

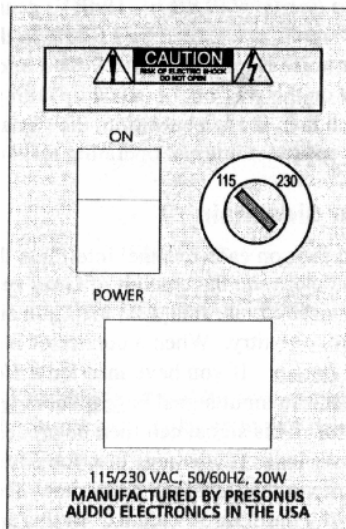

### Power Connection

The **power jack** on your ACP-88 accepts a standard IEC cord like those found on most computers and professional recorders. Your ACP-88 contains a custom built; internal power supply, **no wall wart.** This way you can be assured of clean power and rugged construction that will last!

### Power Selection

Before powering up your ACP-88 for the first time, be sure to check the position of the **power selector switch** on the back of the unit. Make certain that the power voltage level selected matches that of your country's correct power requirements. The arrow on the outside ring of the power selector switch should be aligned with the appropriate voltage. This can be accomplished by inserting a small screwdriver into the slot on the power selector switch and aligning the correct setting beneath the arrow on the outside ring of the power selector switch.

**Power Switch** | =ON 0=OFF. (hmmm....)

# BASIC SETUP & APPLICATIONS

---

## 3.1 Some Basic Patching

### Inserting into your mixers insert points

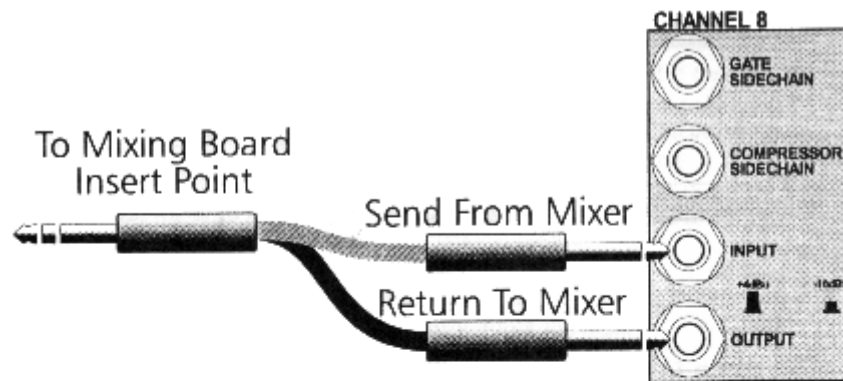

### After your mixers main outputs, balanced.

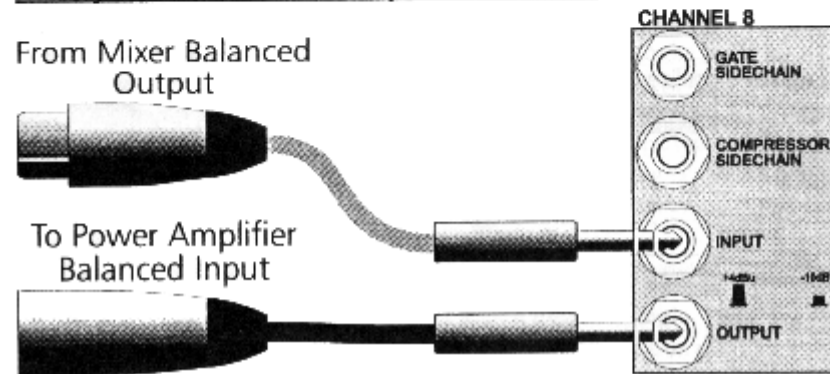

## BASIC SETUP & APPLICATIONS

---

**Between multi-track recorder inputs/outputs to mixer outputs/inputs, unbalanced.**

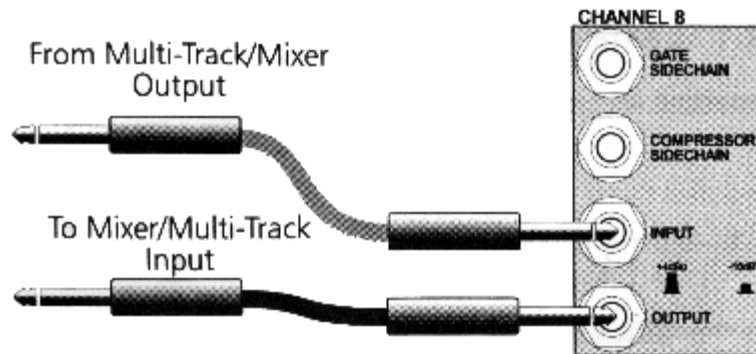

**Sidechain insertion of an equalizer, for de-essing applications.**

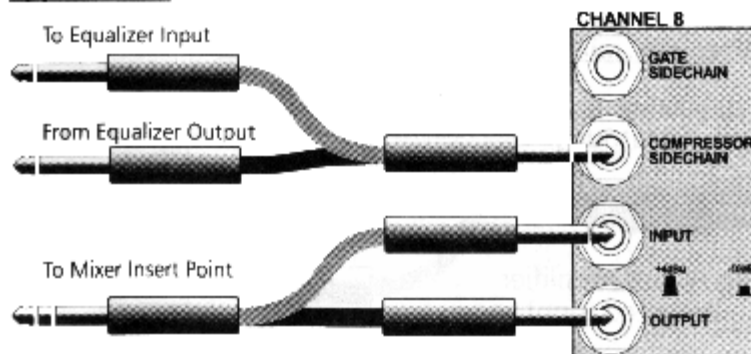

## BASIC SETUP & APPLICATIONS

---

### 3.2 Basic Applications

#### Example setup compressing a voice or vocal track.

Probably the most common use of a compressor is to control the dynamic range of a vocalist during a live performance or when recording. It is almost always necessary to compress a vocal take during a recording session. Most vocalists have a very wide dynamic range, and if the vocalist does not have '*studio*' experience, controlling the dynamic range becomes even more challenging due to the lack of proper microphone technique.

This wide variation in level makes it difficult to properly record a vocal take, especially on digital multi-track recorders which have definite limitations in headroom.

Compressing a vocal also makes it easier to place the vocal track in a mix so that it remains 'in your face' throughout the track.

To setup for recording a vocal, insert a channel of your ACP-88 into the same channel as the microphone on your mixer. If your mixer has an *insert point*, *insert* the compressor there (-10 dBu on most mixers). If you don't have an insert point you will have to place the compressor *after* your mixer's *bus-output* or whichever *output* you're using by coming *out* of your mixer to the **input** of the ACP-88; then **out** of the ACP-88 to the **input** of your recorder. If you're using a stand alone mic preamp; patch the ACP-88 *after* the preamp and then to the recorder. It is important to utilize the compressor *last* in the signal path or positioned in line so that the input level of the compressor is *stable*. (**Remember**: adjusting the signal level being *sent* to the ACP-88 will require a *readjustment* of the various parameters of the compressor.)

Turn the **Threshold** of the channel's compressor you're using completely *counter-clockwise*. If you've gotten the cables right, you should see the LED's above the **Threshold** knob of the channel you're using flashing when you talk into the microphone. Make sure that the channel on the ACP-88 has the following setup: **Link** button is *out*, **Bypass** is *out*, **Auto** is *in*, **Soft** is

## BASIC SETUP & APPLICATIONS

---

out, **Gate Threshold** knob is fully counter-clockwise. Compressor **Ratio** knob is set to **1:1** (fully counter clockwise).

**To set the compressor:** turn the Ratio to the **2:1** mark on the legend. With the vocalist yodeling into the mic, turn the compressor's **Threshold** until the gain reduction meters read about **-7dB**. Now you will probably need to *boost* the compressors' **output** by turning the **Gain** knob clockwise so that your mixer or multi-track meters read **0 dB** (in the case of some digital recorders this is **-14 dB**).

This would be a basic, very simple but useable setting for recording a vocal. Things to vary to suit your taste might be: adjusting the ratio and threshold for more/less dynamic range. Push the **Soft** button in and check out the **Soft Knee** compression curve. Take the compressor out of **Auto** mode and adjust the **Attack** and **Release** times to taste. Get a new vocalist (just kidding).

### **Compressing and gating drums or percussion instruments.**

**Limiting** the dynamic range of a drum kit may or may not be something you want to do to your drum tracks, but there are some other cool things the ACP-88 can do to help you get that "killer" drum sound on tape.

If you consider the sound of a snare drum, you will notice the sound has a beginning loud sound (*transient*) followed by a sound of decreasing intensity (*decay*). Patch a channel of your ACP-88 for compressing the snare drum as described above and we can explore some dramatic changes that compression can have on the snare drum's sound.

For a simple setup, make sure that: **Soft** button is out, **Auto** button is out; **Ratio** is set to **4:1** on the legend; **Attack** is fully counter-clockwise; **Release** is straight up at the **12:00** o'clock position; **Gate Threshold** is fully counter-clockwise; **Link** button is out and the **Bypass** button is out. Adjust the **Threshold** until you see about **-11dB** on the gain reduction meters. At this point, the snare's volume is simply lowered by **11dB**. Now slowly raise the **Attack** time by turning the

## BASIC SETUP & APPLICATIONS

---

**Attack** knob *clockwise*. You should notice that the beginning '*transient*' of your snare sound is starting to jump out of the speakers and slap you in the face. This becomes even more noticeable when using digital reverberation on the snare.

Now you can adjust the **Gate** on the snare to stop those other drums from 'bleeding' through the snare mic: Begin by adjusting the **Attack** time of the **Gate** to **.01** (10 microseconds) by turning the **Gate Attack** control knob *fully counter-clockwise*. Turn the **Gate Release** knob to about the middle position, set the **Gate Range** to **60dB** (*Range Button pushed-in*), adjust the **Gate Threshold** slowly *clockwise* until you begin to hear those other drums disappearing. *Too high* of a **Threshold** setting might disrupt the snare drum's natural sound, a **Threshold** setting that is *too low* will let the sound of the other drums *open* the **Gate**. You need to adjust the **Gate Threshold** and **Release** to suit your drumming taste.

This simple application applies to any percussive instrument, of course. Experiment...

### **Limiting.**

**Limiting** is defined as compressing with a **Ratio** of infinity to one. This setting acts like an imaginary ceiling for the level of a signal. On your ACP-88, **Limiting** occurs when the **Ratio** knob is *fully clockwise*. At this point, the **Threshold** knob essentially becomes the 'ceiling' knob for the channel. You will most likely want a virtually instantaneous **Attack** time while **Limiting**. To achieve this: Make sure the **Auto** button is out, Turn the compressors **Attack** time knob *fully counter-clockwise* and set the compressor's **Release** time for the most natural sounding decay for whatever input signal you are using.

(**Warning:** Improper settings of the **Release** time have been known to cause pumping, breathing and coughing in limiters. Consult your ears when fine tuning.)



## BASIC SETUP & APPLICATIONS

---

### **Compressing bass guitar.**

Very similar to compressing vocals, the bass guitar is almost always compressed or limited during recording. Start with the setting described above for vocals. Vary the Compression **Ratio**, **Attack** and **Release** to suite your taste.

### **Compressing acoustic guitar.**

It is sometimes easy to over compress an acoustic guitar because your first impression is that compression sounds awesome on acoustic instruments. If you're adding the acoustic instrument to a mix that already includes a lot of other instruments such as distorted guitar, compressing the life out of your guitar will help you later in the mix. If the guitar is recorded as a solo instrument or part of an acoustic ensemble, you should experiment with less compression because you don't want to severely limit the natural acoustic dynamic range of a good sounding guitar.

Start by using the setup described in the vocal section...

### **De-essing using an inserted equalizer into the Sidechain.**

A common annoyance when attempting to place a vocal track in a mix is that as you boost the higher frequencies of the track to 'breathe life' into the vocal, all of the 'SSS's of the dialogue or lyrics tend to become louder than the rest of the track. A proven method of redussing thissss problem is to de-ess the track with 'spectral' compression.

Patching a de-esser together is illustrated in the patching diagrams above. If you don't have an external equalizer, you can use a spare channel of your mixer by sending the track to both the spare channel and the original channel. Take the direct out of the spare channel and send it to the **Sidechain** input of the ACP-88 (signal on the tip of the tip-ring-sleeve connector). Once patched, setup the compressor as a limiter as described above. How this works is that when the **Sidechain** has an inserted signal, the **Compressor** generates the **Gain reduction** from the **Sidechain** return signal only. Now, if you boost those frequencies associated with sibilance (SSS),

## BASIC SETUP & APPLICATIONS

---

such as **2kHz** to **8kHz**, the **Compressor** will apply the **Gain reduction** *more* to the sibilance because it is now '*seeing*' more signal around the frequency of the sibilance. You will need to adjust the *frequency* of the equalizer to locate your source of sibilance more precisely. Parametric equalizers are most effective for this type of compression but you can get by with most any equalizer.

### **Stereo Compressing/Limiting.**

The **Linking** feature of your ACP-88 will allow you to have up to *four stereo* **Linked pairs** of **Compressor/Gates**. As you may have read in the section in Chapter Two on the **Link** function, this is easily achieved by pushing *in* the **Link** button on the *right-hand* channel thus creating a **Linked Stereo Pair**. The channel on the *left* becomes the **Master** for the **Linked stereo pair** and all functions on the *Right* channel (with the exception of the **Bypass** switch) become inoperative. **Meters** on the *right channel* will behave as before but have *no* significance since the **Gain reduction** for this channel is being derived from the **Left** channel.

To avoid confusion, it might be useful to turn the **Compression Ratio** to **1:1** on the channel with the **Link** button pushed in (the right channel). This will eliminate all **Gain reduction** and effectively turn off the **Gain reduction meters**. The **Gain reduction** is of course being derived from the **Master** channel.

The **Link** LED indicates when a signal is being *passed* from the **Linked** channel to the *Master* channel. It will **ONLY** *light up* when signal is *applied* to the **Linked** channel.

# TECHNICAL

---

## 4.1 Specifications

Number of Channels.....	8
Dynamic Range.....	>115dB
Signal to Noise Ratio.....	>95dB
Headroom .....	+24dBu, Unbalanced; +18dBu Balanced
Frequency Response .....	10Hz to 50kHz
Crosstalk .....	>82db @ 10kHz
Compression Threshold Range .....	-40dBu to +20dBu
Compression Ratio .....	1:1 to 20:1
Compressor Attack Time.....	0.02ms to 200ms
Compressor Release Time .....	0.5sec to 500sec
Auto Attack and Release .....	Program Dependent
Gate Attack Time .....	0.01ms to 100ms
Gate Threshold Range.....	Off to +20dBu
Gate Release Time .....	0.02sec to 2sec
Gate Attenuation Range .....	-15dB or -60dB
Input Impedance .....	10kOhms
Output Impedance.....	5l Ohms
THD + Noise .....	<0.02%
Output Gain .....	-20dB to +20dB
Compression Curve Types .....	Soft Knee or Hard Knee
Compressor Metering .....	Above and Below Threshold, Gain Reduction
Gate Metering .....	Open and Closed
Sidechain Output Impedance .....	5l Ohms
Sidechain Input Impedance .....	10kOhms
Gate Input Impedance .....	10kOhms
Internal Operating Level.....	+4dBu = 0dB
Input Range .....	+4dBu or -10dBV, Switchable
Input Connectors .....	1/4", Tip Ring Sleeve, Balanced or Unbalanced
Output Connectors .....	1/4", Tip Ring Sleeve, Balanced or Unbalanced
Sidechain Connector .....	1/4", Tip Ring Sleeve
Gate Key Connector .....	1/4", Tip Ring Sleeve
Power Supply .....	Internal, Linear Supply
Power Requirements .....	100VAC to 120VAC, or 200VAC to 240VAC
Weight .....	12lbs.
Rack Size .....	2U

---

# TECHNICAL

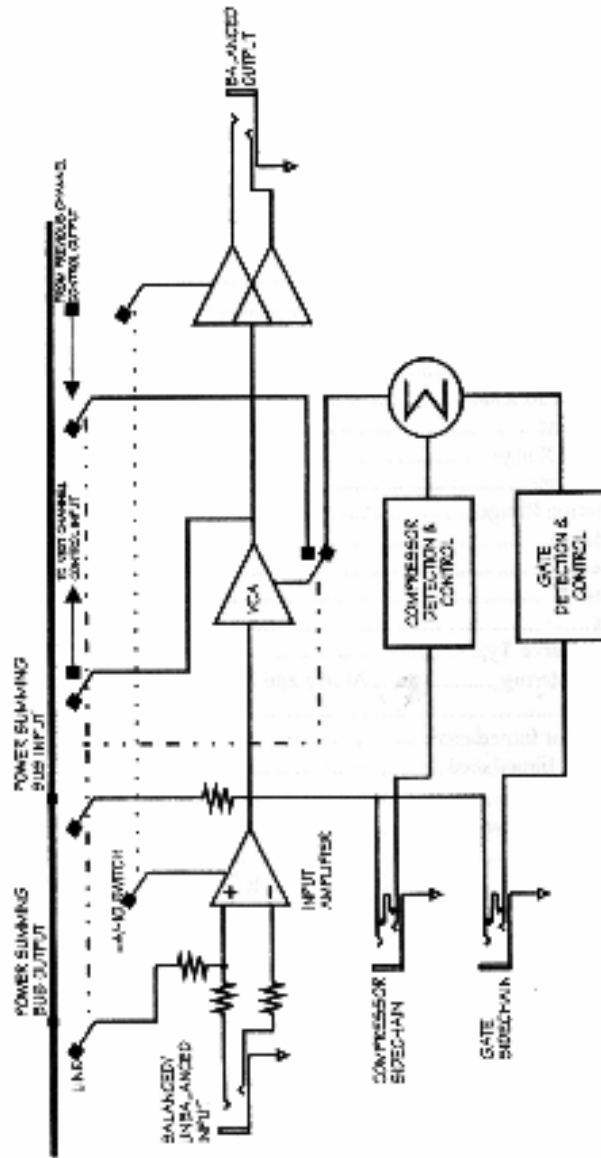

SINGLE CHANNEL BLOCK DIAGRAM