

Pioneer

DJ SYSTEM

XDJ-AERO

<http://pioneerdj.com/support/>

The Pioneer website shown above offers FAQs, information on software and various other types of information and services to allow you to use your product in greater comfort.

<http://rekordbox.com/>

For inquiries on rekordbox™, please see the online support site indicated above.

Operating Instructions

Contents

How to read this manual

In this manual, names of channels and buttons indicated on the product, names of menus in the software, etc., are indicated within square brackets ([]). (e.g. [MASTER] channel, [ON/OFF], [File] menu)

01 Before start

Features	3
What's in the box	4

02 Before you start

Playable USB devices.....	5
Playable music file formats	5
Functions usable in combination with a computer.....	6
About the rekordbox (Mac/Windows) music management software ...	7
Installing the driver software	8

03 Connections

Connecting the input/output terminals.....	10
Connecting by wireless LAN.....	11

04 Part names and functions

Power & wireless section	15
USB device section.....	15
Player section.....	16
Browse section	18
Mixer section.....	20
Effect section.....	21

05 Basic Operation

Installing rekordbox (iOS/Android)	22
Importing tracks.....	22
Loading tracks.....	22
Outputting sound	23
Mixing using the faders.....	24
Disconnecting links.....	24

06 Advanced Operation

Using the auto mix function	25
Using the sample launch function.....	25
Using the jog drum function.....	25
Using the QUANTIZE function	25
Using the SYNC function	26
Using the DJ software	26
About the playback history (HISTORY)	26

07 Changing the settings

About the auto standby function.....	27
Setting preferences	27
List of WLAN INFORMATION items.....	27
List of WLAN SETTING items.....	28

08 List of MIDI Messages

1 Player	29
2 Effects	30
3 Mixer	31

09 Additional information

Troubleshooting.....	33
Error messages.....	35
Block Diagram	36
List of icons displayed on the main unit display section.....	36
About trademarks and registered trademarks	36
Cautions on copyrights	36
Using the online support site	37
Specifications.....	37

Before start

Features

This unit is a DJ system integrating a DJ player and DJ mixer in a single unit and carrying over the high operability of Pioneer's DJ products, the world standard for club equipment. Full-fledged DJ performances can be made easily using tracks not only on USB devices and computers but also on mobile devices (smartphones, tablets, etc.).

MULTI MEDIA, MULTI FORMAT

In addition to music files stored on flash memory or other USB devices, music files stored on mobile devices and computers can also be played. The unit can also be used as a DJ software controller and audio interface.

WIRELESS CONNECTION

This unit is equipped with a wireless LAN function. DJ performances are possible with mobile devices or computers connected by wireless LAN.

rekordbox (iOS/Android)

rekordbox, a smartphone application that can be downloaded free of charge, can be used for the management (analysis, settings, creation, history storage) of music files on mobile devices. Using music files managed with rekordbox (iOS/Android) in combination with this unit makes it possible to achieve outstanding DJ performances.

- In this manual, the iOS/Android edition of rekordbox is referred to as "rekordbox (iOS/Android)".

rekordbox (Mac/Windows)

The included rekordbox (Mac/Windows) music management software can be used for the management (analysis, settings, creation, history storage) of music files on computers. Using music files managed with rekordbox (Mac/Windows) in combination with this unit makes it possible to achieve outstanding DJ performances.

- In this manual, the Mac/Windows edition of rekordbox is referred to as "rekordbox (Mac/Windows)". "rekordbox" is used to indicate the editions of rekordbox (Mac/Windows) and rekordbox (iOS/Android) simultaneously.

LINK EXPORT

When a mobile device or computer is connected by wireless LAN, rekordbox music files and management data can be exchanged directly.

USB EXPORT

rekordbox (Mac/Windows) music files and management data can be exchanged using a USB device.

SOUND CARD

This unit is equipped with a dedicated interface for controlling other brands of DJ software and a MIDI interface. It also has a built-in sound card, allowing simple connection to other devices.

BEAT DISPLAY

The beat position corresponding to the track's BPM and the position of playback are shown on the main unit display. Furthermore, the number of beats in loops and beat effects are displayed, allowing you to check the beat visually for scratch, loop and effect performances.

USB REC

Sound played on this unit during DJ performances can easily be recorded on USB devices (flash memory devices, etc.). The recorded sound can also be played on this unit.

BEAT SYNC

This function can be used to automatically synchronize the tempo (BPM) and beat positions on the left and right decks based on the tracks' GRID information as analyzed with rekordbox. Genuine beat mixing is possible easily, without moving the [TEMPO] sliders.

JOG DRUM

The jog dial's mode can be switched to produce sound when the jog dial is touched. This function allows this unit to be used like a sampler. Furthermore, the sampled sound can be scratched by turning the jog dial at this time.

SAMPLE LAUNCH

Sampled sound sources registered in this unit can be easily loaded onto the respective decks simply by pressing a button.

QUANTIZE

This unit is equipped with a QUANTIZE function letting you set points on beat for tracks analyzed with rekordbox, even if buttons are pressed roughly. When setting auto loop beats and beat effects, the points are automatically set to the beat nearest the position at which the button was pressed.

AUTO MIX

Tracks registered in playlists can automatically be played alternately on [DECK1] and [DECK2]. When the point 30 seconds before the end of the currently playing track is reached, the two tracks are automatically mixed and playback of the next track starts.

AUTO BEAT LOOP

Loops can be set automatically without breaking the beat by pressing the [AUTO BEAT LOOP] control. The loop's number of beats can be changed by turning the [AUTO BEAT LOOP] control clockwise or counterclockwise.

BEAT EFFECT

Beat effects are provided for each of the decks. Beat effects can be applied individually to the tracks currently playing on the respective deck. Beat effects can also be applied to other devices connected to the mixer section's input terminals.

SOUND COLOR FILTER

Each channel is equipped with a SOUND COLOR FILTER function for achieving filter effects easily simply by turning the controls. This lets you arrange and mix tracks intuitively during DJ performances.

3BAND EQ

This unit is equipped with a 3-band equalizer allowing the volume of the high, medium and low frequency ranges to be adjusted separately. Not only can the tone be adjusted to your tastes, the sound for a certain range can be turned completely off by turning the control all the way counterclockwise (isolator function).

EXTERNAL INPUT

This unit is equipped with inputs for connecting such external devices as CD players or analog players. DJ performances are possible using the two sets of inputs, [CH 1] (channel 1) and [CH 2] (channel 2).

What's in the box

- CD-ROM (containing rekordbox (Mac/Windows), the driver software and the operating instructions. The rekordbox (Mac/Windows) license key is attached.)
- AC adapter
- Power cord
- Warranty card
- Read Before Use (Important)
- Quick Start Guide
- Notice on software licenses

Before you start

Playable USB devices

This unit supports USB mass storage class USB devices (external hard disks, portable flash memory devices, digital audio players, etc.).

Folder layers	Max. 8 layers
Max. number of folders	1 000 folders
Max. number of files	10 000 files (1 000 files for files not managed by rekordbox (Mac/Windows))
Supported file systems	FAT16, FAT32 and HFS+

When there are many folders or files, some time may be required for loading.

Folders and files exceeding the limits cannot be displayed.

USB devices that cannot be used

- Optical disc type devices such as external DVD/CD drives, etc., are not supported.
- USB hubs cannot be used.

Cautions on using USB devices

- Some USB devices may not operate properly on this unit. Note that Pioneer will accept no responsibility whatsoever for any loss of data recorded on USB devices resulting from connection to this unit.
- It may happen that, when a current above the allowable level is detected in this unit's USB port, the **[USB STOP]** indicator flashes, the power supply to the USB device is cut off and communications with the USB device are interrupted. To restore normal operation, disconnect the USB device from this unit. Avoid reusing USB devices for which an excess current has been detected. If normal operation is not restored (if communications cannot be established) after the above procedure is performed, try turning off this unit's power then turning it back on.
- If the USB device is split into multiple partitions, only the first partition can be used.
- USB devices equipped with flash card readers may not operate.
- Depending on the USB device you are using, the desired performance may not be achieved.
- For devices formatted in MAC OS Extended (Journaled), the rekordbox (Mac/Windows) library information cannot be used.

Playable music file formats

This unit supports music files in the formats shown below.

Type	File extension	Compatible formats	Bit depth	Bit rate	Sampling frequency	Encoding method
MP3	.mp3	MPEG-1	16 bit	32 kbps to 320 kbps	44.1 kHz	CBR, VBR
AAC	.m4a, .aac and .mp4	MPEG-4 AAC LC	16 bit	16 kbps to 320 kbps	44.1 kHz	CBR, VBR
WAV	.wav	WAV	16 bit	—	44.1 kHz	Uncompressed PCM
AIFF	.aif, .aiff	AIFF	16 bit	—	44.1 kHz	Uncompressed PCM

About MP3 files

MP3 files can have a constant bit rate (CBR) or a variable bit rate (VBR). Both types of files can be played on this unit, but the search and super fast search functions are slower with VBR files. If your priority is operability, we recommend recording MP3 files in CBR.

About WAV and AIFF files

File transfer via wireless LAN is not supported for WAV and AIFF files.

About AAC files

- AAC is the abbreviation of "Advanced Audio Coding", a basic format of audio compression technology used for MPEG-2 and MPEG-4.
- The file format and extension of AAC data depends on the application used to create the data.
- On this unit, in addition to AAC files encoded with iTunes® and with the extension ".m4a", files with the extensions ".aac" and ".mp4" files can also be played. However, AAC files that are copyright-protected, such as those purchased from the iTunes Store, cannot be played. Also, depending on the version of iTunes in which the file was encoded, it may not be possible to play the file.

Functions usable in combination with a computer

About the included CD-ROM

This unit can be used in combination with a computer when the software is installed onto the computer from the included CD-ROM. The included CD-ROM contains the following two software programs.

❖ rekordbox (Mac/Windows) music management software

Music files used for DJ play can be managed. The management information can be transferred using USB devices (page 7).

❖ Driver software

When operating DJ software on the computer using this unit, the sound of the music file that is playing can be output from this unit (page 8).

Software end user license agreement

This Software End User License Agreement ("Agreement") is between you (both the individual installing the Program and any single legal entity for which the individual is acting) ("You" or "Your") and PIONEER CORPORATION ("Pioneer").

TAKING ANY STEP TO SET UP OR INSTALL THE PROGRAM MEANS THAT YOU ACCEPT ALL OF THE TERMS OF THIS LICENSE AGREEMENT. PERMISSION TO DOWNLOAD AND/OR USE THE PROGRAM IS EXPRESSLY CONDITIONED ON YOUR FOLLOWING THESE TERMS. WRITTEN OR ELECTRONIC APPROVAL IS NOT REQUIRED TO MAKE THIS AGREEMENT VALID AND ENFORCEABLE. IF YOU DO NOT AGREE TO ALL OF THE TERMS OF THIS AGREEMENT, YOU ARE NOT AUTHORIZED TO USE THE PROGRAM AND MUST STOP INSTALLING IT OR UNINSTALL IT, AS APPLICABLE.

1 Definitions

- 1 "Documentation" means written documentation, specifications and help content made generally available by Pioneer to aid in installing and using the Program.
- 2 "Program" means all or any part of Pioneer's software licensed to You by Pioneer under this Agreement.

2 Program license

- 1 Limited License. Subject to this Agreement's restrictions, Pioneer grants to You a limited, non-exclusive, nontransferable, license (without the right to sublicense):
 - a To install a single copy of the Program on the hard disk drive of Your computer, to use the Program only for Your personal purpose complying with this Agreement and the Documentation ("Authorized Use");
 - b To use the Documentation in support of Your Authorized Use; and
 - c To make one copy of the Program solely for backup purposes, provided that all titles and trademark, copyright and restricted rights notices are reproduced on the copy.
- 2 Restrictions. You will not copy or use the Program or Documentation except as expressly permitted by this Agreement. You will not transfer, sublicense, rent, lease or lend the Program, or use it for third-party training, commercial time-sharing or service bureau use. You will not Yourself or through any third party modify, reverse engineer, disassemble or decompile the Program, except to the extent expressly permitted by applicable law, and then only after You have notified Pioneer in writing of Your intended activities. You will not use the Program on multiple processors without Pioneer's prior written consent.
- 3 Ownership. Pioneer or its licensor retains all right, title and interest in and to all patent, copyright, trademark, trade secret and other intellectual property rights in the Program and Documentation, and any derivative works thereof. You do not acquire any other rights, express or implied, beyond the limited license set forth in this Agreement.

- 4 No Support. Pioneer has no obligation to provide support, maintenance, upgrades, modifications or new releases for the Program or Documentation under this Agreement.

3 Warranty disclaimer

THE PROGRAM AND DOCUMENTATION ARE PROVIDED "AS IS" WITHOUT ANY REPRESENTATIONS OR WARRANTIES, AND YOU AGREE TO USE THEM AT YOUR SOLE RISK. TO THE FULLEST EXTENT PERMISSIBLE BY LAW, PIONEER EXPRESSLY DISCLAIMS ALL WARRANTIES OF ANY KIND WITH RESPECT TO THE PROGRAM AND DOCUMENTATION, WHETHER EXPRESS, IMPLIED, STATUTORY, OR ARISING OUT OF COURSE OF PERFORMANCE, COURSE OF DEALING OR USAGE OF TRADE, INCLUDING ANY WARRANTIES OF MERCHANTABILITY, FITNESS FOR A PARTICULAR PURPOSE, SATISFACTORY QUALITY, ACCURACY, TITLE OR NON-INFRINGEMENT.

4 Damages and remedies for breach

You agree that any breach of this Agreement's restrictions would cause Pioneer irreparable harm for which money damages alone would be inadequate. In addition to damages and any other remedies to which Pioneer may be entitled, You agree that Pioneer may seek injunctive relief to prevent the actual, threatened or continued breach of this Agreement.

5 Termination

Pioneer may terminate this Agreement at any time upon Your breach of any provision. If this Agreement is terminated, You will stop using the Program, permanently delete it from the computer where it resides, and destroy all copies of the Program and Documentation in Your possession, confirming to Pioneer in writing that You have done so. Sections 2.2, 2.3, 2.4, 3, 4, 5 and 6 will continue in effect after this Agreement's termination.

6 General terms

- 1 Limitation of Liability. In no event will Pioneer or its subsidiaries be liable in connection with this Agreement or its subject matter, under any theory of liability, for any indirect, incidental, special, consequential or punitive damages, or damages for lost profits, revenue, business, savings, data, use, or cost of substitute procurement, even if advised of the possibility of such damages or if such damages are foreseeable. In no event will Pioneer's liability for all damages exceed the amounts actually paid by You to Pioneer or its subsidiaries for the Program. The parties acknowledge that the liability limits and risk allocation in this Agreement are reflected in the Program price and are essential elements of the bargain between the parties, without which Pioneer would not have provided the Program or entered into this Agreement.
- 2 The limitations or exclusions of warranties and liability contained in this Agreement do not affect or prejudice Your statutory rights as consumer and shall apply to You only to the extent such limitations or exclusions are permitted under the laws of the jurisdiction where You are located.
- 3 Severability and Waiver. If any provision of this Agreement is held to be illegal, invalid or otherwise unenforceable, that provision will be enforced to the extent possible or, if incapable of enforcement, deemed to be severed and deleted from this Agreement, and the remainder will continue in full force and effect. The waiver by either party of any default or breach of this Agreement will not waive any other or subsequent default or breach.
- 4 No Assignment. You may not assign, sell, transfer, delegate or otherwise dispose of this Agreement or any rights or obligations under it, whether voluntarily or involuntarily, by operation of law or otherwise, without Pioneer's prior written consent. Any purported assignment, transfer or delegation by You will be null and void. Subject to the foregoing, this Agreement will be binding upon and will inure to the benefit of the parties and their respective successors and assigns.
- 5 Entire Agreement. This Agreement constitutes the entire agreement between the parties and supersedes all prior or contemporaneous agreements or representations, whether written or oral, concerning its subject matter. This Agreement may not be

modified or amended without Pioneer's prior and express written consent, and no other act, document, usage or custom will be deemed to amend or modify this Agreement.

- 6 You agree that this Agreement shall be governed and construed by and under the laws of Japan.

Cautions on installing the software

Read *Software end user license agreement* carefully before installing rekordbox (Mac/Windows) and the driver software.

- The included CD-ROM contains installation programs in the following 12 languages.
English, French, German, Italian, Dutch, Spanish, Portuguese, Russian, Chinese (simplified characters), Chinese (traditional characters), Korean, Japanese.
- When using an operating system in any language besides the ones listed above, select **[English]** during the installation procedure.

Supported operating systems	rekordbox (Mac/Windows)	Driver software
Mac OS X (10.5.8, 10.6 or 10.7)	✓	✓
Windows® 7 Home Premium/ Professional/Ultimate	32-bit version ✓	✓
	64-bit version ✓	✓ ¹⁾
Windows Vista® Home Basic/ Home Premium/Business/ Ultimate (SP2 or later)	32-bit version ✓	✓
	64-bit version ✓	✓ ¹⁾
Windows® XP Home Edition/ Professional (SP3 or later)	32-bit version ✓	✓

- ¹⁾ When using a 64-bit version of Windows, the driver software can only be used for 32-bit applications.

❖ Minimum operating environment for rekordbox (Mac/Windows)

Check that the computer provides the operating environment described below before starting installation.

CPU	For Mac OS X Macintosh computer equipped with a Dual-Core 1.6 GHz or greater Intel® processor
	For Windows® 7, Windows Vista® and Windows® XP PC/AT compatible computer equipped with a Dual-Core 2.0 GHz or greater Intel® processor
Required memory	1 GB or more of RAM
Hard disk	250 MB or more of free space (not including space for storing music files, etc.)
Optical drive	Optical disc drive on which the CD-ROM can be read
Sound	Audio output to speakers, headphones, etc. (internal or external audio device)
Internet connection	For user registration and inquiries, use a web browser supporting 128-bit SSL (Safari 2.0 or greater, Internet Explorer® 6.0 or greater, etc.).
USB port	A USB port for connection of a USB device (flash memory, hard disc, etc.) is required to transfer music files to the USB device.

- Full functionality is not guaranteed on all computers, even those meeting the operating environment requirements described above.
- Even with the required memory capacity indicated for the operating environment above, in the cases described below the software may not provide full functionality and performance due to lack of memory. In this case, take the necessary measures to ensure sufficient free memory. We recommend adding extra memory in order to achieve stable performance.
 - When there are many tracks being managed in the rekordbox (Mac/Windows) library
 - When resident programs and services are running
- Depending on the computer's power settings and other factors, the CPU and hard disk processing capacity may be insufficient. When using laptop computers in particular, always keep the AC power connected and adjust the computer's settings to maximize performance when using rekordbox (Mac/Windows).
- Note that problems may arise with the functionality of rekordbox (Mac/Windows) depending on other software running on your computer.

About the rekordbox (Mac/Windows) music management software

rekordbox (Mac/Windows) is a software program for purchasers of the XDJ-AERO or other Pioneer DJ players to manage the music files they use for DJ play.

- rekordbox (Mac/Windows) may be used for classifying and searching for music files stored on your computer as well as creating playlists, all of which can help improve your DJ performance.
- rekordbox (Mac/Windows) allows the detecting, measuring, and editing of beats, tempos (BPM), and other elements of your music files prior to a performance.

Installing rekordbox (Mac/Windows)

❖ For Mac OS X

Read *Cautions on installing the software* carefully before installing rekordbox (Mac/Windows).

- Authorization of the computer's administrator is required to install and uninstall rekordbox (Mac/Windows).
Log on as the user which was set as the computer's administrator before installing.

1 When the included CD-ROM is inserted into the computer's CD drive, the CD drive opens on the screen. Double-click the [CD_menu.app] icon.

- If the CD drive does not open on the screen when the CD-ROM is inserted, use Finder to open the CD drive, then double-click the [CD_menu.app] icon.

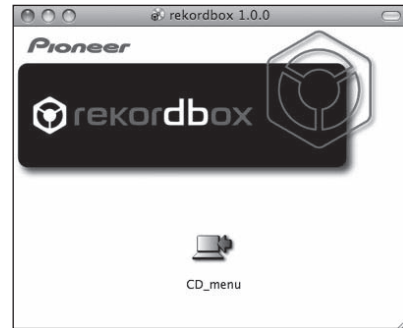

2 When the CD-ROM's menu is displayed, select [rekordbox: Install Music Management Software], then click [Start].

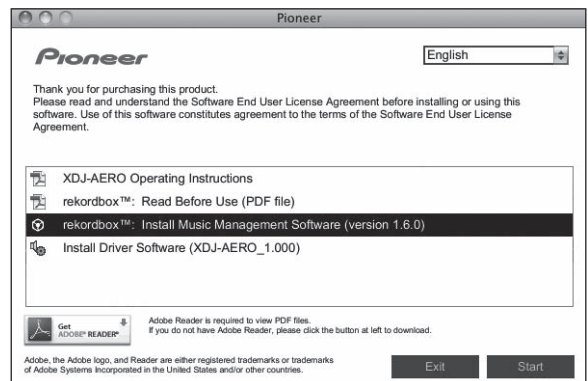

- To close the CD-ROM menu, click **[Exit]**.

3 Install rekordbox (Mac/Windows) following the instructions on the screen.

❖ For Windows® 7, Windows Vista® and Windows® XP

Read *Cautions on installing the software* carefully before installing rekordbox (Mac/Windows).

- Authorization of the computer's administrator is required to install and uninstall rekordbox (Mac/Windows).
Log on as the user registered as the computer's administrator before installing rekordbox (Mac/Windows).

1 Insert the included CD-ROM into the computer's CD drive.

The CD-ROM menu is displayed.

- If the CD-ROM menu does not appear when the CD-ROM is inserted, open the CD drive from [**Computer** (or **My Computer**)] in the [**Start**] menu, then double-click the [**CD_menu.exe**] icon.

2 When the CD-ROM's menu is displayed, select [rekordbox: Install Music Management Software], then click [Start].

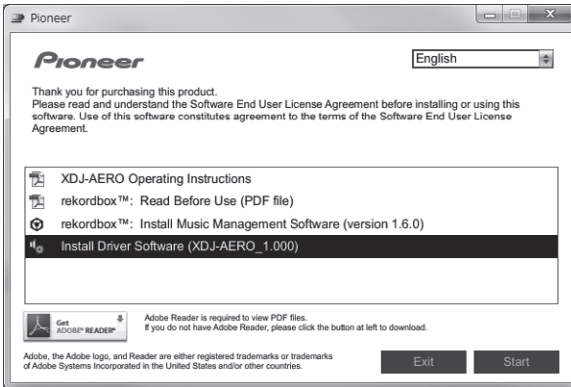

- To close the CD-ROM menu, click [**Exit**].

3 Install rekordbox (Mac/Windows) following the instructions on the screen.

- Click [**Cancel**] to cancel installation after it has started.

Launching rekordbox (Mac/Windows)

Log on as the user which was set as the computer's administrator before using rekordbox (Mac/Windows).

- When rekordbox (Mac/Windows) is started up for the first time, the license key must be input. The license key is affixed to the CD-ROM package.
- When rekordbox (Mac/Windows) is started up, the operating instructions can be viewed from the rekordbox (Mac/Windows) [**Help**] menu.

❖ For Mac OS X

Open the [Application] folder with Finder, then double-click [rekordbox (Mac/Windows) 1.x.x.app].

- The 1.x.x indicates the rekordbox (Mac/Windows) version.

❖ For Windows® 7, Windows Vista® and Windows® XP

Click on the Windows [Start] menu button, then [All Programs] > [Pioneer] > [rekordbox (Mac/Windows) 1.x.x] > [rekordbox (Mac/Windows) 1.x.x].

- The 1.x.x indicates the rekordbox (Mac/Windows) version.

Installing the driver software

This driver software is designed exclusively for inputting and outputting sound from the computer. To use this unit connected to a computer on which a Windows or Mac OS is installed, first install this driver software on the computer.

Before installing the driver software

- Read *Cautions on installing the software* on page 7 carefully.
- Turn off this unit's power switch, then disconnect the USB cable connecting this unit and the computer.
- If any other programs are running on the computer, quit them.
- To install or uninstall the driver software, you need to be authorized by the administrator of your computer. Log on as the administrator of your computer before proceeding with the installation.
- If you connect this unit to your computer without installing the driver software first, an error may occur on your computer depending on the system environment.
- If installation of the driver software is interrupted after it has started, start the installation procedure over again from the beginning.

For Mac OS X

1 When the included CD-ROM is inserted into the computer's CD drive, the CD drive opens on the screen. Double-click the [CD_menu.app] icon.

- If the CD drive does not open on the screen when the CD-ROM is inserted, use Finder to open the CD drive, then double-click the [CD_menu.app] icon.

2 When the CD-ROM menu appears, select [Install Driver Software(XDJ-AERO_Driver)], then click [Start].

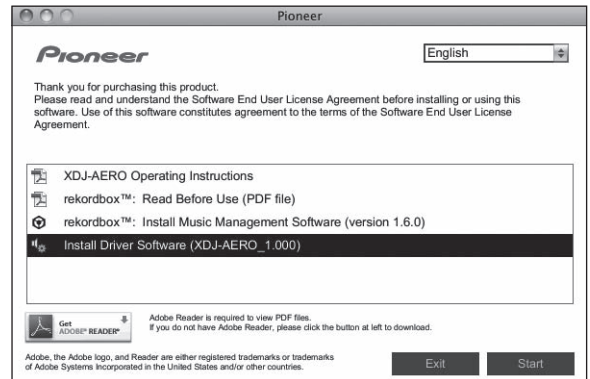

- To close the CD-ROM menu, click [**Exit**].

3 Proceed with installation according to the instructions on the screen.

For Windows® 7, Windows Vista® and Windows® XP

1 Insert the included CD-ROM into the computer's CD drive.

The CD-ROM menu is displayed.

- If the CD-ROM menu does not appear when the CD-ROM is inserted, open the CD drive from [**Computer** (or **My Computer**)] in the [**Start**] menu, then double-click the [**CD_menu.exe**] icon.

2 When the CD-ROM menu appears, select [Install Driver Software(XDJ-AERO_Driver)], then click [Start].

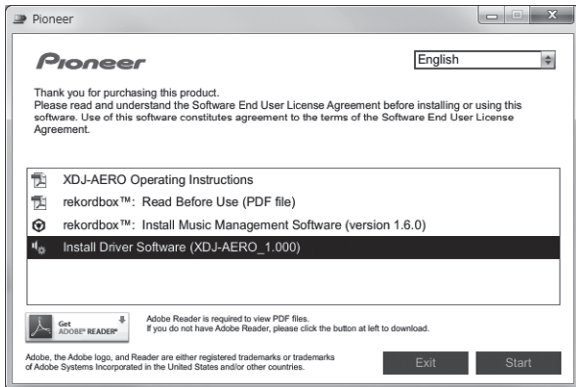

- To close the CD-ROM menu, click [Exit].

3 Proceed with installation according to the instructions on the screen.

If [Windows Security] appears on the screen while the installation is in progress, click [Install this driver software anyway] and continue with the installation.

- When installing on Windows XP
If [Hardware Installation] appears on the screen while the installation is in progress, click [Continue Anyway] and continue with the installation.
- When the installation program is completed, a completion message appears.

Connecting this unit and computer

1 Connect this unit to your computer via a USB cable.

For instructions on connections, see *Connecting the input/output terminals* on page 10.

2 Press [STANDBY/ON] button.

Turn on the power of this unit.

3 Press the [MIDI] button.

The [CONTROL MODE] screen appears on the main unit display.

- The message [Installing device driver software] may appear when this unit is first connected to the computer or when it is connected to a different USB port on the computer. Wait a while until the message [Your devices are ready for use] appears.
- When installing on Windows XP
 - [Can Windows connect to Windows Update to search for software?] may appear while the installation is in progress. Select [No, not this time], then click [Next] to continue installation.
 - [What do you want the wizard to do?] may appear while the installation is in progress. Select [Install the software automatically (Recommended)], then click [Next] to continue installation.
 - If [Hardware Installation] appears on the screen while the installation is in progress, click [Continue Anyway] and continue with the installation.

Adjusting the buffer size (when using Windows ASIO)

This unit functions as an audio device conforming to the ASIO standards.

- If an application using this unit as the default audio device (DJ software, etc.) is running, quit that application before adjusting the buffer size.

Click the Windows [Start] menu>[All Programs]>[Pioneer]>[XDJ-AERO]>[XDJ-AERO Settings Utility].

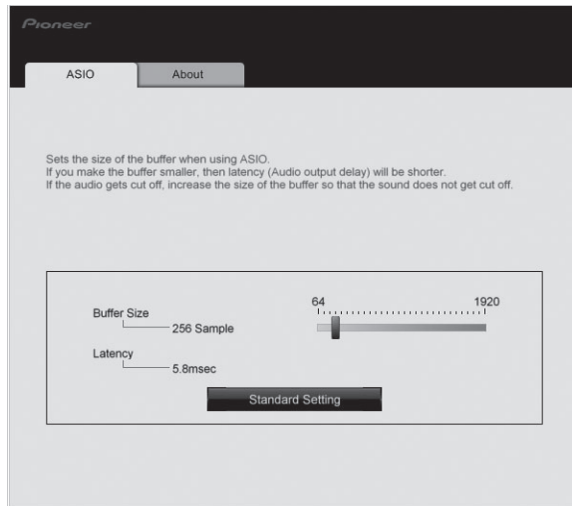

- If the buffer size is made large, drops in audio data (breaks in the sound) occur less easily, but the time lag due to the delay in the transfer of the audio data (latency) increases.

Checking the version of the driver software

❖ For Mac OS X

Click [Macintosh HD] icon > [Application] > [Pioneer] > [XDJ-AERO] > [XDJ-AERO driver version display utility]. [XDJ-AERO driver version display utility] is displayed.

❖ For Windows® 7, Windows Vista® and Windows® XP

Click the Windows [Start] menu>[All Programs]>[Pioneer]>[XDJ-AERO]>[XDJ-AERO Settings Utility].

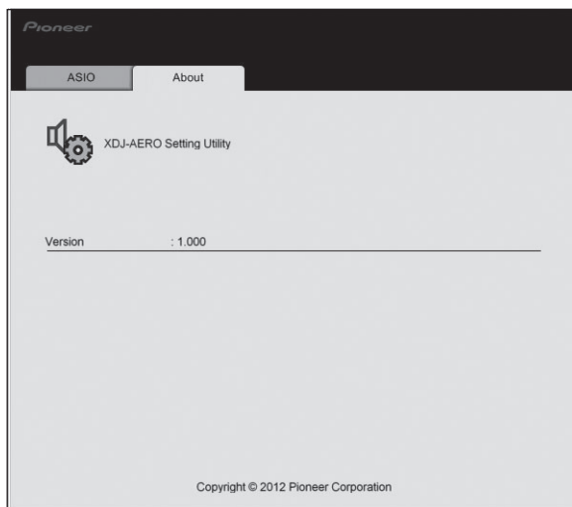

Checking the latest information on the driver software

For the latest information on the driver software for exclusive use with this unit, visit our website shown below.
<http://pioneerdj.com/support/>

Connections

- Connect the power cord after all the connections between devices have been completed.
Be sure to turn off the power and unplug the power cord from the power outlet whenever making or changing connections.
Refer to the operating instructions for the component to be connected.
- Be sure to use the power cord and AC adapter included with this product.

Connecting the input/output terminals

Rear panel, front panel

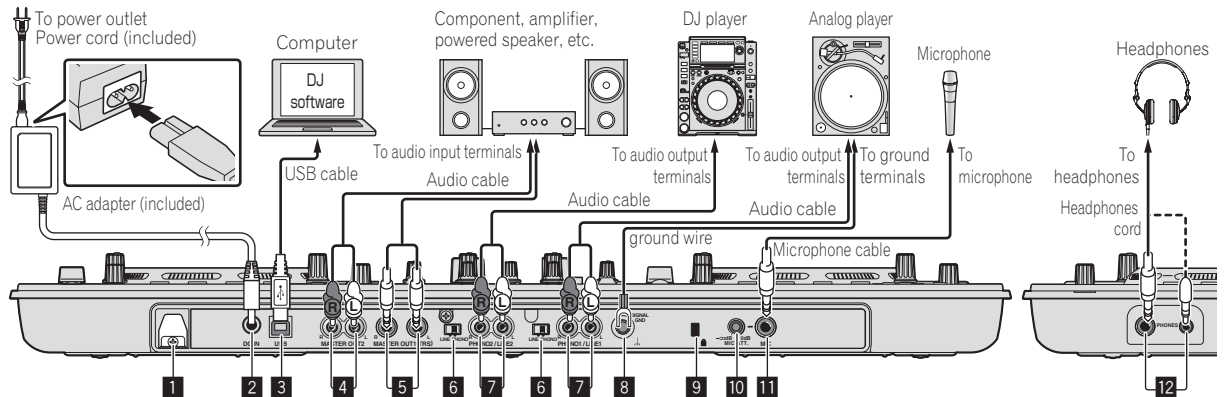

1 Cord hook

Catch the AC adapter's power cord and USB cable on this hook when using this unit.

- The sound will be interrupted if the AC adapter or USB cable is disconnected during playback.

Using the cord hook

Fasten the AC adapter's power cord and USB cable in place by hooking them on the cord hook. This prevents the power cord and USB cable from being accidentally pulled and the plugs from being disconnected from the terminals.

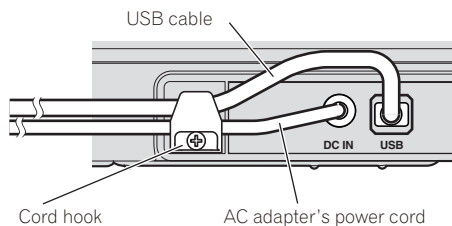

2 DC IN terminal

Connect the included AC adapter's DC plug here. Wait until all connections of the equipment are completed before connecting the power cord.

Be sure to use the power cord and AC adapter included with this product.

3 USB terminal

Connect to a computer.

- A USB hub cannot be used.

4 MASTER OUT 2 terminals

Connect to a power amplifier, etc.

5 MASTER OUT 1 terminals

Connect powered speakers, etc., here.

Compatible with balanced or unbalanced output for a TRS connector.

6 LINE, PHONO selector switch

Switches the function of the [PHONO/LINE] terminals.

7 PHONO1/LINE1 and PHONO2/LINE2 terminals

Connect a phono level output device (analog player (for MM cartridges), etc.) or a line level output device (DJ player, etc.) here. Switch the terminals' function according to the connected device using the [LINE, PHONO] selector switch on this unit's rear panel.

8 SIGNAL GND terminal

Connects an analog player's ground wire here. This helps reduce noise when the analog player is connected.

9 Kensington security slot

10 MIC ATT. control

Adjusts the audio level input to the [MIC] terminal.

- The gain of the sound input to the microphone differs greatly according depending on the microphone being used. The [MIC ATT.] control on this unit's rear panel is used to adjust the audio level according to the microphone before DJ performances. During DJ performances, use the [MIC LEVEL] control on the top of this unit to adjust the microphone's volume.

11 MIC jack

Connects a microphone here.

12 PHONES jacks

Connect headphones here.

Both stereo phone plugs (Ø 6.3 mm) and stereo mini phone plugs (Ø 3.5 mm) can be used.

- There are two input jacks, both a stereo phones jack and a mini phones jack, but do not use both simultaneously. If both are used simultaneously, when one is disconnected and/or connected, the volume of the other may increase or decrease suddenly.

Connecting by wireless LAN

On this unit, wireless LAN connections can be used to connect to mobile devices or computers supporting wireless LAN connections and hold DJ performances using music files on the mobile devices or computers.

To make DJ performances using a wireless LAN, the LINK EXPORT function must be used after making the wireless LAN connection then establishing the link.

For instructions on establishing the link, see the User's Manual for rekordbox (iOS/Android) or the Operating Instructions for rekordbox (Mac/Windows).

About the wireless LAN function's operation mode

On this unit, the wireless LAN function's operation mode can be switched according to the usage purpose. There are two operation modes for the wireless LAN function, as described below.

Access point (AP) mode

In this case, this unit is the main unit on the LAN network. Data is exchanged directly with the mobile devices or computers through wireless connections.

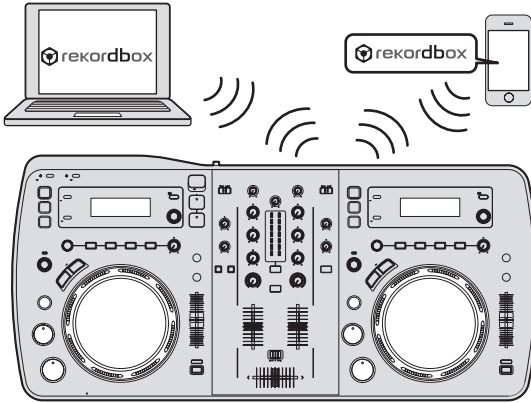

WLAN client mode

In this case, this unit is a sub unit on the LAN network. Data is exchanged with the mobile devices or computers via a wireless LAN access point device.

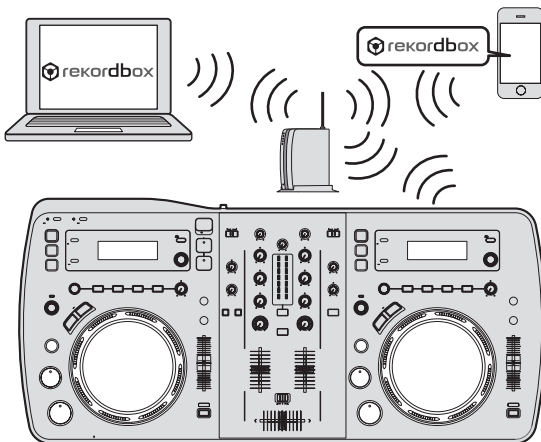

Setting the wireless LAN function's operation mode

Set the wireless LAN function's operation mode before connecting this unit by wireless LAN.

The buttons and controls below are used for making the wireless LAN function's operation mode settings and wireless LAN connection settings.

- By default, the access point (AP) mode is set.

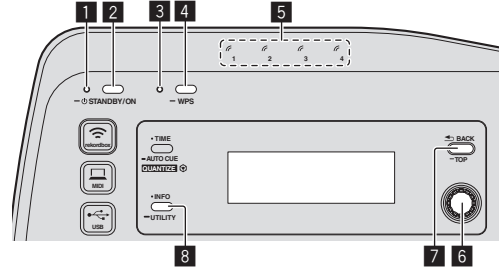

- 1 STANDBY/ON indicator
- 2 STANDBY/ON button
- 3 WPS indicator
- 4 WPS button
- 5 Link indicators
- 6 Rotary selector
- 7 BACK(TOP) button
- 8 INFO(UTILITY) button

1 Press [STANDBY/ON] button.

Turn on the power of this unit.
The [STANDBY/ON] indicator lights green.

2 Press the [INFO(UTILITY)] button for over 1 second.

The [UTILITY] screen is displayed.

3 Turn the rotary selector, select [WLAN SETTING], then press the rotary selector.

See page 28 for the list of [WLAN SETTING] items.

4 Turn the rotary selector, select [MODE], then press the rotary selector.

5 Turn the rotary selector, select the mode you want to set, then press the rotary selector.

- [ACCESS POINT(AP)]: Sets this unit to the access point (AP) mode. This unit is set as the master unit on the network.
- [WLAN CLIENT]: Sets this unit to the WLAN client mode. This unit is set as a sub unit on the network.
- [OFF]: Turns the wireless LAN function off.

6 When [APPLY CHANGES?] appears on the main unit display, turn the rotary selector to select [YES], then press the rotary selector.

Now make the connection settings for the access point (AP) or WLAN client mode (page 12).

Setting the wireless LAN connections in the access point (AP) mode

If the device to be connected supports the WPS standard, make the connection settings using the WPS button, the WPS PIN or manually.

If the device to be connected does not support the WPS standard, make the connection settings manually.

- Before starting, turn on this unit's power.
- If connections cannot be established approximately 2 minutes after the connection settings operations below are performed, the [WPS] indicator turns off.
- With connection settings in the access point (AP) mode, note that connection with the mobile device or computer is not established if no link indicator is lit, even if the [WPS] indicator is off.

❖ Connecting using the [WPS] button

1 Select connection by WPS button (PBC connection) with the WPS connection function of a mobile device or computer.

- See your device's operating instructions for instructions on connecting using the WPS button.

2 Press this unit's [WPS] button for over 1 second.

The [WPS] indicator flashes.

Once the setting is completed, the [WPS] indicator turns off.

❖ Connecting by inputting the WPS PIN code

1 Check the PIN code in the WPS connection function on the mobile device or computer.

- See your device's operating instructions for instructions on checking the WPS PIN code.

2 Press the [INFO(UTILITY)] button for over 1 second.

3 Turn the rotary selector, select [WLAN SETTING], then press the rotary selector.

4 Turn the rotary selector, select [INPUT WPS PINCODE], then press the rotary selector.

5 Use the rotary selector to input the mobile device's or computer's PIN code.

Once the setting is completed, the [WPS] indicator turns off.

❖ Connecting by manual input

1 Press the [INFO(UTILITY)] button for over 1 second.

2 Turn the rotary selector, select [WLAN INFORMATION], then press the rotary selector.

3 Turn the rotary selector, select [SSID], then press the rotary selector.

Make a note of the [SSID] for future reference.

- The first 11 characters of the [SSID] are displayed. Turn the rotary selector to display the portion that is not initially displayed.

4 Press the [BACK(TOP)] button.

Press to return to the previous screen.

5 Turn the rotary selector, select [PASSWORD], then press the rotary selector.

Make a note of the [PASSWORD] for future reference.

6 From the wireless LAN connection settings on the mobile device or computer, display the connectable [SSID]s.

- See your device's operating instructions for instructions on searching for or displaying connectable [SSID]s.

7 On the mobile device or computer, select the [SSID] checked in step 3.

8 Input the password you made a note of in step 5.

Setting the wireless LAN connections in the WLAN client mode

If the access point to which you want to connect supports the WPS standard, make the connection settings using the WPS button, the WPS PIN code or manually.

If the access point to which you want to connect does not support the WPS standard, make the connection settings manually.

- Before starting, turn on this unit's power.
- If connections cannot be established approximately 2 minutes after the connection settings operations below are performed, the [WPS] indicator turns off.
- Previously connected devices are connected automatically with priority, without making the settings.

❖ Connecting using the [WPS] button

1 Press the access point's WPS button.

- See your device's operating instructions for instructions on connecting using the WPS button.

2 Press this unit's [WPS] button for over 1 second.

The [WPS] indicator flashes.

Once the setting is completed, the [WPS] indicator turns on.

❖ Connecting by inputting this unit's WPS PIN code

1 Press the [INFO(UTILITY)] button for over 1 second.

2 Turn the rotary selector, select [WLAN SETTING], then press the rotary selector.

3 Turn the rotary selector, select [Show PINCODE], then press the rotary selector.

This unit's PIN code is displayed.

Make a note of the PIN code.

4 Press the rotary selector.

The [WPS] indicator turns on.

5 With access point WPS connection settings, input the PIN code displayed in step 3.

Once the setting is completed, the [WPS] indicator turns on.

- See your device's operating instructions for instructions on inputting the PIN code.

❖ Connecting by manual input

1 Press the [INFO(UTILITY)] button for over 1 second.

2 Check the access point's [SSID] and password.

- See your device's operating instructions for instructions on checking the [SSID] and password.

3 Turn the rotary selector, select [WLAN SETTING], then press the rotary selector.

4 Turn the rotary selector, select [SELECT SSID], then press the rotary selector.

Up to 10 access points in the area are displayed.

5 Turn the rotary selector, select the [SSID] checked in step 2, then press the rotary selector.

- If the corresponding device's [SSID] is not displayed on the list of access points in the area, or to specify an [SSID] that is intentionally not displayed through use of a stealth function, etc., the device can

be specified by selecting **[OTHER]** then inputting the SSID/security (encryption) type/password.

6 Use the rotary selector to input the **[PASSWORD]**.

Once the setting is completed, the **[WPS]** indicator turns on.

Checking the current wireless LAN settings

1 Press the **[INFO(UTILITY)]** button for over 1 second.

The **[UTILITY]** screen is displayed.

2 Turn the rotary selector, select **[WLAN INFORMATION]**, then press the rotary selector.

See page 27 for the list of **[WLAN INFORMATION]** items.

3 Select the item you want to check, then press the rotary selector.

The settings are displayed.

- When the **[BACK(TOP)]** button is pressed, the screen returns to the **[WLAN INFORMATION]** screen.

4 Press the **[INFO(UTILITY)]** button.

The **[UTILITY]** screen closes.

Part names and functions

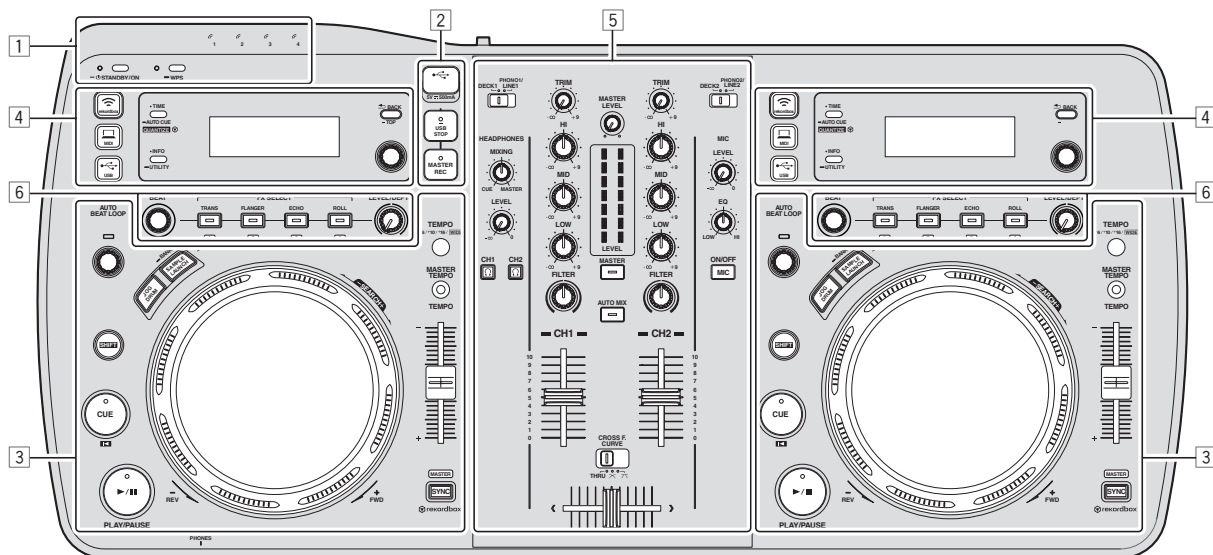

- 1 Power & wireless section (page 15)
- 2 USB device section (page 15)
- 3 Player section (page 16)
- 4 Browse section (page 18)
- 5 Mixer section (page 20)
- 6 Effect section (page 21)

Power & wireless section

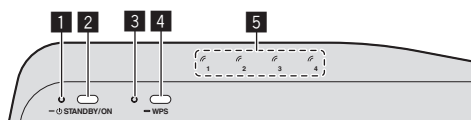

1 STANDBY/ON indicator

This lights when this unit's power is on or in standby.

2 STANDBY/ON button

This switches this unit's power between on and standby.

3 WPS indicator

This lights when connection with an access point is established when in the WLAN client mode.

The indicator flashes during WPS connection settings.

4 WPS button

This is used for wireless LAN connection to devices supporting connection by WPS button.

5 Link indicators

This lights when a link with the mobile device or computer is established.

To turn the power on

Press [STANDBY/ON] button.

Turn on the power of this unit.

The [STANDBY/ON] indicator lights green.

To set to the standby mode

When this unit's power is on, press the [STANDBY/ON] button for over 1 second.

This unit is set to the standby mode.

The [STANDBY/ON] indicator lights red.

- When the [STANDBY/ON] button is pressed again, the power turns on.
- This unit is equipped with an auto standby function. For details, see *About the auto standby function* on page 27.

USB device section

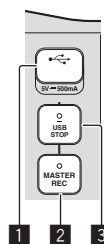

1 USB device insertion slot

Insert USB devices here.

2 MASTER REC button

This is used to record the sound output from this unit on a USB device.

3 USB STOP button

Press this for over 2 seconds before disconnecting USB devices from this unit.

Recording the performance

The same sound as the sound being output from the [MASTER OUT 1] and [MASTER OUT 2] terminals can be recorded as a WAV file on a USB device.

- The name of the files created when the sound is recorded is in the format [REC***.WAV] (***) is a 3-digit number).

1 Connect the USB device to the USB device insertion slot.

2 Press the [MASTER REC] button.

Recording starts.

The [MASTER REC] indicator lights.

- When the [MASTER REC] button is pressed again, the [MASTER REC] indicator turns off and recording stops.
- Recording is possible for about 90 minutes on a 1 GB USB device.
- Recording is not possible on devices formatted in MAC OS Extended (Journaled).

Player section

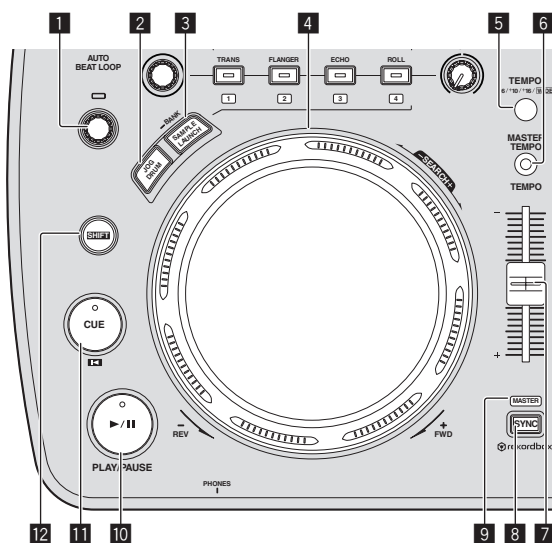

1 AUTO BEAT LOOP control

- Turn:
Set the length of the auto beat loop's loop in units of beats.
- Press:
Turns loop playback on and off.

2 JOG DRUM button

Use this to turn the jog drum function on and off.
➔ *Using the jog drum function (p.25)*

3 SAMPLE LAUNCH button

Use this to load this unit's internal sampled sound sources.
➔ *Using the sample launch function (p.25)*

4 Jog dial

- Scratch
When the jog dial is set to the [VINYL] mode and the jog dial is turned while pressing down on its top, the sound is played in the direction and at the speed at which the jog dial is turned.
- Pitch bend
The playing speed can be adjusted by turning the outer part of the jog dial during playback.

5 TEMPO RANGE button

The [TEMPO] slider's range of variation switches each time this is pressed.

6 MASTER TEMPO button

Use this to turn the master tempo function on and off.

7 TEMPO slider

Use this to adjust the track playing speed.

8 SYNC button

Synchronizes to the master deck's tempo.
➔ *Using the SYNC function (p.26)*

9 MASTER indicator

This lights when the SYNC function is set to "MASTER".

10 ►/II (PLAY/PAUSE) button

Use this to play/pause tracks.

11 CUE button

- Press:
Sets a cue point or moves the cue point.
- [SHIFT] + press:
The playing position moves to the beginning of the track.

12 SHIFT button

When another button is pressed while pressing the [SHIFT] button, a different function is called out.

Playback

Press the [►/II (PLAY/PAUSE)] button.

❖ Pausing

During playback, press the [►/II (PLAY/PAUSE)] button.

- Playback resumes when [►/II (PLAY/PAUSE)] button is pressed again.
- When the jog dial is turned while pausing, the position can be moved in units of 10 msec.

Forward and reverse scanning

Turn the jog dial while pressing the [SHIFT] button.

The track is fast-forwarded/fast-reversed in the direction in which the jog dial is spun.

- When the [SHIFT] button is released, this function is canceled.
- When you stop the jog dial from spinning, normal playback resumes.
- The fast-forward/fast-reverse speed can be adjusted according to the speed at which the jog dial is spun.

Adjusting the playing speed (Tempo control)

Move the [TEMPO] slider forward or backward.

The playing speed increases when the slider is moved to the [+] side (towards you), decreases when the slider is moved to the [-] side (away from you).

The rate at which the playing speed is changed is indicated on the main unit display.

❖ Selecting the playing speed adjustment range

Press the [TEMPO RANGE] button.

The playing speed adjustment range switches each time the button is pressed.

[WIDE, ±16, ±10, ±6] lights on the main unit display.

❖ Adjusting the playing speed without changing the pitch (Master Tempo)

Press the [MASTER TEMPO] button.

The [MASTER TEMPO] indicator lights. The pitch does not change even when the playing speed is changed with the [TEMPO] slider.

- The sound is digitally processed, so the sound quality changes.

Setting Cue

1 During playback, press the [►/II (PLAY/PAUSE)] button.

Playback is paused.

2 Press the [CUE ] button.

The point at which the track is paused is set as the cue point. The [►/II (PLAY/PAUSE)] indicator flashes and the [CUE ] indicator lights. No sound is output at this time.

- When a new cue point is set, the previously set cue point is canceled.

❖ Adjusting the cue point position

1 Turn the jog dial while pausing at a cue point.

The [▶/II (PLAY/PAUSE)] and [CUE ] indicators flash.
The cue point can be fine-adjusted in units of 10 msec.

2 Press the [CUE] button.

The position at which the button was pressed is set as the new cue point.

- When a new cue point is set, the previously set cue point is canceled.

❖ Returning to Cue Point (Back Cue)

During playback, press the [CUE] button.

The set immediately returns to the currently set cue point and pauses.

- When the [▶/II (PLAY/PAUSE)] button is pressed, playback starts from the cue point.

❖ Checking Cue Point (Cue Point Sampler)

Keep pressing the [CUE] button after returning to the cue point.

Playback starts from the set cue point. Playback continues while the button is held in.

Setting the loop automatically based on the track's tempo (Auto Beat Loop)

1 During playback, turn the [AUTO BEAT LOOP] control to set the length for loop playback in number of beats.

The main unit display switches to the beat display.

2 Press the [AUTO BEAT LOOP] control to start loop playback.

The loop out point is set automatically according to the track's tempo (BPM) and loop playback starts.

- Loop playback cannot be performed properly if the BPM value is not displayed.
- When auto beat loop is set, the cue point moves to the loop in point.
- When the [AUTO BEAT LOOP] control is pressed during loop playback, loop playback is canceled.

Operating the jog dial

- The top of the jog dial has an embedded switch. Do not place objects on the jog dial or subject it to strong forces.
- Water or other liquids getting into the set will lead to malfunction.

❖ Scratch

1 Press the [JOG DRUM] button.

The jog dial indicator lights blue.
Switch the jog dial to the VINYL mode.

2 During playback, press the top of the jog dial.

Playback stops.

3 Spin the jog dial in the desired direction and at the desired speed.

The sound is played according to the direction and speed at which the jog dial is spun by spinning the top of the jog dial while pressing it.

4 Release your hand from the top of the jog dial.

Normal playback resumes.

❖ Pitch bend

During playback, spin the outer section of the jog dial without touching the top.

The playing speed increases when spun clockwise, decreases when spun counterclockwise. When spinning is stopped, playback returns to the normal speed.

❖ Jog drum

For details on the jog drum function, see *Using the jog drum function* on page 25.

Browse section

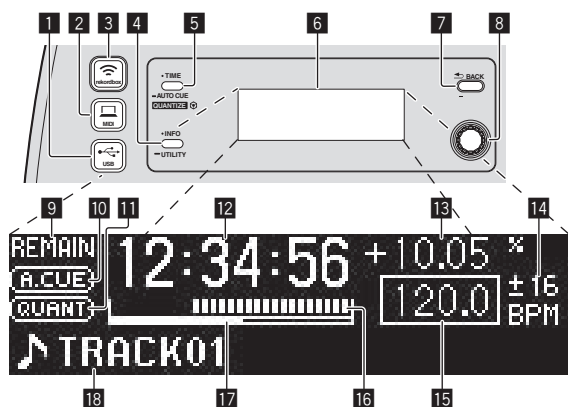

1 USB button

Use this to browse the contents of the USB device connected to this unit and display them on the main unit display.

- When rekordbox (Mac/Windows) library information is stored on the USB device, the main unit display switches to the browse display mode when the button is pressed.

2 MIDI button

This unit switches to the PC control mode.

3 rekordbox button

A list of the mobile devices and computers connected to this unit and on which rekordbox is installed is displayed.

4 INFO(UTILITY) button

- Press:
The main unit display switches to the information display mode. When in the information display mode, the bottom section of the display switches between the track name and beat display each time the button is pressed.
- Press for over 1 second:
The [UTILITY] screen is displayed.

5 TIME (AUTO CUE, QUANTIZE) button

- Press:
The main unit display's time display mode switches to the elapsed time or remaining time display.
- Press for over 1 second:
When pressed for over 1 second, auto cue turns on and off.
➔ *Setting auto cue* (p.19)
- [SHIFT] + press:
This turns the QUANTIZE function on and off.
➔ *Using the QUANTIZE function* (p.25)

6 Main unit display

7 BACK(TOP) button

- Press:
The screen moves back to the layer above.
- Press for over 1 second:
Press for over 1 second to move to the top layer.

8 Rotary selector

9 REMAIN

This lights when the time display is set to the remaining time.

10 A. CUE

This lights when auto cue is set.

11 QUANTIZE

This is displayed when [QUANTIZE] is turned on.

12 Time display (minutes, seconds, milliseconds)

13 Playing speed display

The value changes according to the position of the [TEMPO] slider.

14 Playing speed adjustment range display

This indicates the range in which the playing speed can be adjusted with respect to the original playing speed recorded on the medium.

15 BPM

Displays BPM (Beats Per Minute) of the track currently being played.

16 Playing address display

The track is displayed as a bar graph. The current playback position is displayed as a white vertical line. When the elapsed time is displayed, the left edge of the graph lights. When the remaining time is displayed, the display turns off from the left side. The entire graph flashes slowly when there are less than 30 seconds remaining in the track, then begins flashing rapidly when less than 15 seconds remain.

17 Caching meter

When tracks are loaded from a device connected by wireless LAN, the amount of data loaded into this unit is displayed here. When all the indicators on the caching meter are lit, this indicates that one track's worth of data has been loaded into this unit.

- This is not displayed when tracks are loaded from a USB device or for tracks with long playing times (MP3 files with lengths of approximately 10 minutes or greater, etc.).

18 Information display section

Switching the browse display mode

There are two types of browse display modes: library browse and folder browse. The display mode differs according to whether or not rekordbox (Mac/Windows) library information is stored on the USB device.

- When library information is stored on the USB device: The information is displayed in the library browse mode. The music files are displayed in the categories (album, artist, etc.) set with rekordbox (Mac/Windows).
The category types can be changed in the [Preferences] in rekordbox (Mac/Windows).
- When no library information is stored on the USB device: The information is displayed in the folder browse mode. The folders and tracks on the medium are displayed in a tree structure.

When the [USB] button is pressed, the mode switches to the browse display mode.

Searching for tracks quickly using the library information

When library information created using rekordbox (Mac/Windows) is recorded on the USB device, the library information can be used to quickly search for tracks.

❖ Searching by specifying the first character (jump)

When the item names in the category are sorted in alphabetical order, you can move to items beginning with the specified character.

- This function may not work for some categories.

1 Press the [USB] button.

Switch to the [BROWSE] display.

2 Turn the rotary selector then press it.

Select the category.

3 Press the rotary selector for at least 1 second.

The mode switches to the character jump mode.

4 Turn the rotary selector.

The character displayed in the top left switches.
Select the character to which you want to move.

5 Press the rotary selector.

The display switches to the item selected in step 4.

❖ Searching by inputting a character string

This function lets you display only the artists, albums, tracks or files containing the character string you input.

- Categories not selected in the [Preferences] in rekordbox (Mac/Windows) are not displayed.

1 Press the [← USB] button.

Switch to the [BROWSE] display.

2 Turn the rotary selector.

Select [SEARCH].

3 Press the rotary selector.

The display switches to the character input screen.

4 Using the rotary selector to input characters.

Turn the rotary selector and select the desired character, then press the rotary selector to enter that character.

- Repeat this operation to input other characters.

5 Once you have completed inputting the character string, press the rotary selector.

Only items containing the character string you have input are displayed.

Switching the information display mode

The bottom section of the display switches between the track name and beat display each time the [INFO(UTILITY)] button is pressed.

❖ Using the beat display function

This displays the beat and playback position of the currently playing track.

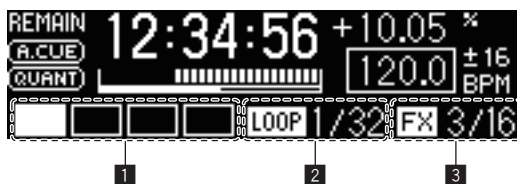

1 Beat display section

2 Auto loop display section

3 Effect display section

- When display of track name is selected in the information display mode, the mode automatically switches to the beat display when one of the operations below is performed.
 - Scratch
 - Auto beat loop setting
 - Effect setting

Setting auto cue

When a track is loaded or the track search operation is performed, the silent section at the beginning of the track is skipped and the cue point is automatically set at the point immediately before the sound starts.

Press the [TIME (AUTO CUE, QUANTIZE)] button for over 1 second.

Auto cue is set to on.

[A. CUE] lights on the main unit display.

- When the [TIME (AUTO CUE, QUANTIZE)] button is pressed again for over 1 second, auto cue is set to off.
- The auto cue level setting remains in the memory, even when the power is turned off.

❖ Changing the auto cue level

The acoustic pressure level identified as a silent section with the auto cue function can be selected from eight levels.

- The auto cue level setting remains in the memory, even when the power is turned off.

1 Press the [INFO(UTILITY)] button for over 1 second.

The [UTILITY] screen is displayed.

2 Turn the rotary selector then press it.

Select [A. CUE LEVEL].

3 Turn the rotary selector then press it.

The auto cue level setting changes.

Mixer section

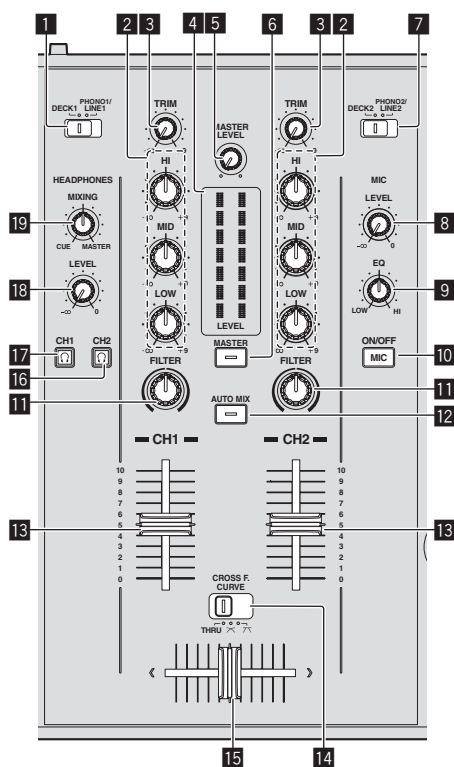

1 DECK1/PHONO1/LINE1 selector switch

This selects the [CH 1] input source from among the devices connected to this unit.

- When set to [PHONO/LINE], the mixer section can be used as a DJ mixer. In this case, the effect sections of the respective decks can be used.

2 EQ (HI, MID, LOW) controls

These adjust the sound quality of the respective channels.

These adjust the [HI] (high range), [MID] (middle range) and [LOW] (low range), respectively.

3 TRIM control

Adjusts the level of audio signals input in each channel.

4 LEVEL indicator

This displays the audio levels of the respective channels.

- Press the [MASTER] button to switch the channel whose audio level is displayed.

5 MASTER LEVEL control

Adjusts the audio level output from the [MASTER OUT 1] and [MASTER OUT 2] terminals.

6 MASTER button

This switches the channel indicated on the [LEVEL] indicator.

- When off: The audio level input to [CH 1] (channel 1) and [CH 2] (channel 2) is displayed on the [LEVEL] indicator.
- When lit: The audio level output from the [MASTER OUT 1] and [MASTER OUT 2] terminals is displayed on the [LEVEL] indicator.

7 DECK2/PHONO2/LINE2 selector switch

This selects the [CH 2] input source from among the devices connected to this unit.

- When set to [PHONO/LINE], the mixer section can be used as a DJ mixer. In this case, the effect sections of the respective decks can be used.

8 MIC LEVEL control

Adjusts the audio level input to the [MIC] terminal.

- Use the [MIC ATT.] control on this unit's rear panel to adjust the audio level before DJ performances.

9 MIC EQ control

This adjusts the microphone's sound quality.

10 MIC (ON/OFF) button

Turns the microphone on/off.

11 FILTER control

- Turn clockwise to apply the high pass filter.
- Turn counterclockwise to apply the low pass filter.
- ↻ Using the filter function (p.21)

12 AUTO MIX button

This turns the auto mix function on and off.

13 Channel fader

Adjusts the level of audio signals output in each channel.

14 CROSS F. CURVE (THRU, ^, v) (crossfader curve selector switch)

This switches the crossfader curve characteristics.

15 Crossfader

The sound of the respective channels is output according to the curve characteristics selected with the [THRU, ^, v] selector switch.

16 (CH2) button

The sound of [CH 2] is monitored.

17 (CH1) button

The sound of [CH 1] is monitored.

18 HEADPHONES LEVEL control

Adjusts the audio level output from the [PHONES] terminal.

19 HEADPHONES MIXING control

Adjusts the balance of the monitor volume between the sound of the deck whose [] button is pressed and the master sound.

Adjusting the sound quality

Turn the [HI], [MID], [LOW] controls for the respective channels.

- The sound for that range can be turned completely off by turning the control all the way counterclockwise (isolator function).

Monitoring sound with headphones

1 Connect headphones to the [PHONES] terminal.

For instructions on connections, see *Connecting the input/output terminals* on page 10.

2 Press the [] (CH1) or [] (CH2) button.

Select the channel you want to monitor.

- This operation is not necessary to monitor the sound output from the [MASTER OUT 1] and [MASTER OUT 2] terminals (the sound of the master channel).

3 Turn the [HEADPHONES MIXING] control.

- When turned counterclockwise: The volume of [CH 1] and [CH 2] becomes relatively louder.
- At the center position: The volume of the [CH 1] and [CH 2] sound is the same as the volume of the sound output from the [MASTER OUT 1] and [MASTER OUT 2] terminals (the sound of the master channel).

- When turned clockwise: The volume of the sound output from the [MASTER OUT 1] and [MASTER OUT 2] terminals (the sound of the master channel) becomes relatively louder.

4 Turn the [HEADPHONES LEVEL] control.

Sound is output from the headphones.

- When the [CH1] button or [CH2] button is pressed again, monitoring is canceled.
- Monitoring of the sound output from the [MASTER OUT 1] and [MASTER OUT 2] terminals (the sound of the master channel) cannot be canceled.

Using a microphone

1 Press the [MIC (ON/OFF)] button.

2 Turn the [MIC LEVEL] control clockwise.

The sound of the microphone is output from the speakers.

- Adjust the [MIC ATT.] control on the rear panel as necessary (page 10).

❖ Adjusting the sound quality

Turn the [MIC EQ] control.

- When turned fully clockwise, the attenuation of the bass sound is maximum.
- When turned fully counterclockwise, the attenuation of the treble sound is maximum.

Using the filter function

The sound of the high or low range is filtered out, greatly changing the tone.

Turn the [FILTER] control.

- Right: An effect as if the low range was gradually cut is achieved.
- Left: An effect as if the high range was gradually cut is achieved.

Effect section

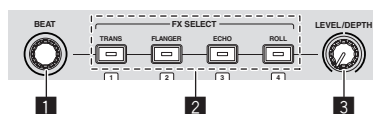

1 BEAT control

This is used to select the beat multiple to which the effect is synchronized.

2 FX SELECT (TRANS, FLANGER, ECHO, ROLL) buttons

Turns the effects on and off.

3 LEVEL/DEPTH control

Adjusts the quantitative parameter of the effect.

Using the beat effect function

This unit is equipped with four effect buttons. Effects can be applied to the sound by pressing one of the effect buttons.

Press one of the [FX SELECT (TRANS, FLANGER, ECHO, ROLL)] buttons.

The button that was pressed flashes.

The effect is applied in beat with the track.

The effect differs for the different buttons. For details on the different effects, see the table below.

- When a button that is flashing is pressed again, the effect is turned off.

Effect Name	Descriptions	LEVEL/DEPTH
TRANS	Cuts the sound according to the beat multiple set with the [BEAT] control.	Sets the balance between the original sound and the effect sound.
FLANGER	Creates a one-cycle flanger effect according to the beat multiple set with the [BEAT] control.	The further the control is turned clockwise, the more the effect is stressed. When turned all the way counterclockwise, only the original sound is output.
ECHO	Outputs a delay sound several times that attenuates gradually according to the beat multiple set with the [BEAT] control. With 1/1 beat echoes, the delay sounds are faded out according to the track's tempo even after the input sound has been cut.	Use this to set the balance between the original sound and the echo sound.
ROLL	Records the input sound at the point the [ROLL] button is pressed and repeatedly outputs the recorded sound according to the beat multiple set with the [BEAT] control.	Sets the balance between the original sound and the roll sound.

❖ Varying the effect

Turn the [LEVEL/DEPTH] control.

The effect changes according to the direction in which the [LEVEL/DEPTH] control is turned and its position.

Basic Operation

Preparations must be made using the procedure shown on the diagram below in order to make DJ performances using a wireless LAN.

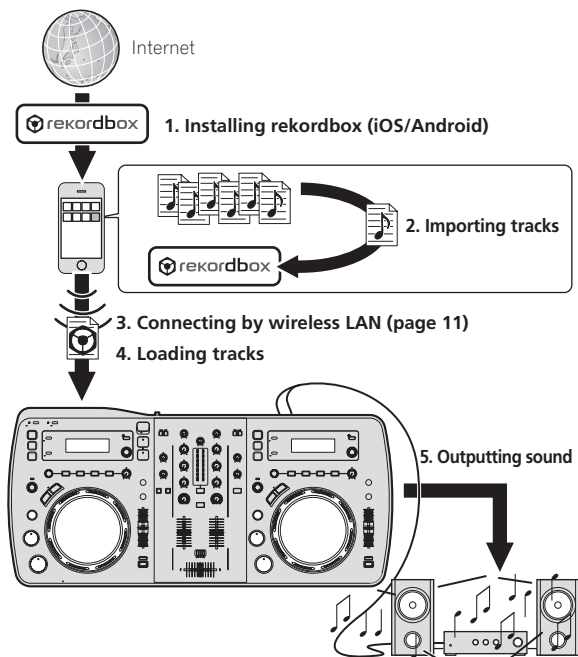

- Loading tracks from mobile devices or computers via wireless LAN
- Loading tracks on USB devices connected to this unit from mobile devices by browsing via wireless LAN
- Using this unit's rotary selector to load tracks from a mobile device or computer via wireless LAN
- Loading tracks from USB devices

To make DJ performances using a wireless LAN, the LINK EXPORT function must be used after making the wireless LAN connection then establishing the link.

For making wireless LAN connections, see *Connecting by wireless LAN* on page 11.

For instructions on establishing the link, see the User's Manual for rekordbox (iOS/Android) or the Operating Instructions for rekordbox (Mac/Windows).

When a link is established with a mobile device or computer, one of link indicators 1 to 4 lights. (Which link indicator(s) light(s) depends on the number of units connected simultaneously.)

- The maximum total number of units (mobile devices and/or computers) with which links can be established simultaneously is four.

Loading tracks from mobile devices or computers via wireless LAN

- 1 Connect the mobile device or computer to this unit via wireless LAN.
- 2 Launch rekordbox on the mobile device or computer and establish the link.
- 3 Operate rekordbox on the mobile device or computer to select the track.
- 4 Operate rekordbox on the mobile device or computer to select the deck on which the track is to be loaded, then tap or click.
Track loading starts. The jog dial indicator on the deck on which the track is being loaded flashes. Once playback is possible, the jog dial indicator stops flashing, remaining lit, the track name is displayed on the main unit display and playback starts (by factory default).

Installing rekordbox (iOS/Android)

Download the rekordbox (iOS/Android) application using a mobile device or computer, then install it on the mobile device.

rekordbox (iOS/Android) can be used on your mobile device.

- The rekordbox (iOS/Android) application can be downloaded from the App Store or Google Play.

Importing tracks

In order to play tracks (music files) on a mobile device or computer on this unit, the tracks must first be analyzed then added to the rekordbox library.

- The following describes the procedure for importing tracks into rekordbox on a mobile device.
For the procedure for importing tracks into rekordbox on a computer, see the Operating Instructions for rekordbox (Mac/Windows).

1 At the rekordbox (iOS/Android) top menu, tap the import button.

A list of music files on the mobile device is displayed.

2 Tap the music file you want to add to the library.

The selected music file is displayed in gray.

- Multiple music files can be selected simultaneously. To add all the displayed music files, tap the add all tracks button.

3 Tap the import button.

Analysis of the music file(s) begins.

Once analysis of the music file(s) is completed, the track(s) is (are) added to the rekordbox (iOS/Android) library.

Loading tracks on USB devices connected to this unit from mobile devices by browsing via wireless LAN

- 1 Connect the mobile device by wireless LAN.
- 2 Launch rekordbox on the mobile device and establish the link.
- 3 Connect the USB device to this unit's USB device insertion slot.
- 4 Operate rekordbox on the mobile device to select the track.
- 5 Operate rekordbox on the mobile device to select the deck on which the track is to be loaded, then tap.
Track loading starts. The jog dial indicator on the deck on which the track is being loaded flashes. Once playback is possible, the jog dial indicator stops flashing, remaining lit, the track name is displayed on the main unit display and playback starts (by factory default).

Loading tracks

There are four ways to load tracks into this unit, as described below.

Using this unit's rotary selector to load tracks from a mobile device or computer via wireless LAN

1 Connect the mobile device or computer to this unit via wireless LAN.

2 Launch rekordbox on the mobile device or computer and establish the link.

3 Press this unit's [📶 rekordbox] button.

The mobile devices or computers connected to this unit are displayed on the main unit display.

4 Turn this unit's rotary selector to select the mobile device or computer, then press the rotary selector.

Use this unit's rotary selector to select the mobile device or computer to be operated.

5 Turn this unit's rotary selector to select the track from the track collection in rekordbox on the mobile device or computer.

- To move to lower layers in a folder, select the folder then press the rotary selector.
- To return to a higher level, press the [BACK (TOP)] button.
- When the [BACK (TOP)] button is pressed for over 1 second, the screen moves back to the layer above.

6 Press this unit's rotary selector.

Track loading starts. The jog dial indicator on the deck on which the track is being loaded flashes.

Once playback is possible, the jog dial indicator stops flashing, remaining lit, the track name is displayed on the main unit display and playback starts (by factory default).

Loading tracks from USB devices

1 Connect the USB device to the USB device insertion slot.

2 Press the [← USB] button.

The tracks on the USB device are displayed on the main unit display.

3 Turn the rotary selector.

Select the track.

- To move to lower layers in a folder, select the folder then press the rotary selector.
- To return to a higher level, press the [BACK (TOP)] button.
- When the [BACK (TOP)] button is pressed for over 1 second, the screen moves back to the layer above.

4 Press the rotary selector.

The track is loaded and playback begins.

❖ Disconnecting USB devices

Always perform the following procedure to disconnect USB devices. Pulling the USB device out without performing this procedure could make the USB device unreadable.

When turning this unit's power off, be sure to remove the USB device first.

1 Press the [USB STOP] button for over 2 seconds.

The USB indicator turns off.

2 Disconnect the USB device.

Outputting sound

Before outputting sound, check that this unit and the surrounding devices are properly connected. For instructions on connecting, see *Connecting the input/output terminals* on page 10 or *Connecting by wireless LAN* on page 11.

Set the volume of the power amplifiers connected to the [MASTER OUT 1] and [MASTER OUT 2] terminals to an appropriate level. Note that very loud sounds will be output if the volume is set too high.

When playing tracks via wireless LAN, playback may become impossible due to deterioration of the communication conditions. In this case, loop playback begins automatically and [EMERGENCY LOOP] is displayed on the main unit display.

When communications conditions recover, the [EMERGENCY LOOP] display turns off. Press the [AUTO BEAT LOOP] control at this time to cancel looping.

To output the sound of channel 1 [CH 1]

To output the sound of [CH 2] (channel 2), replace [CH 1] with [CH 2], [DECK 1] with [DECK 2] and [PHONO1/LINE1] with [PHONO2/LINE2] in the procedure below.

1 Switch the [DECK1, PHONO1/LINE1] selector switch in the [CH 1] section.

Select the input source for [CH 1] from among the devices connected to this unit.

- [DECK1]: Selects the USB device or the unit connected by wireless LAN.
- [PHONO1/LINE1]: Selects the device connected to the [PHONO1/LINE1] terminals.

2 Press the [MASTER] button at the center of this unit.

Set so that the [MASTER] button is off.

- When the [MASTER] button is off, the audio level input to [CH 1] and [CH 2] is displayed on the [LEVEL] indicator.

3 Turn the [CH 1] [TRIM] control clockwise.

Adjusts the audio level input to the [CH 1] terminal.

The [LEVEL] indicator lights when sound is properly being input to [CH 1].

Adjust the [TRIM] control so that the orange indicator lights where the track's volume is highest (at the climax, etc.)

Be careful that the red indicator does not light, or the sound could be distorted.

4 Move the [CH 1] channel fader to the back side.

The level of the sound output from the [CH 1] terminals is adjusted.

5 Switch [CROSS F. CURVE THRU, ↗, ↘] (the crossfader curve selector switch).

This switches the crossfader curve characteristics.

- [THRU]: Choose this when you do not want to use the crossfader.
- [↗]: Set here for a curve that rises gradually.
- [↘]: Set here for a curve that rises steeply. (When the crossfader moves away from either the left or right edge, the sound is immediately output from the opposite side.)

6 Set the crossfader.

Switch the channel whose sound is output from the speakers.

- Left edge: The [CH 1] sound is output.
- Center position: The sound of [CH 1] and [CH 2] is mixed and output.
- Right edge: The [CH 2] sound is output.

- This operation is not necessary when the [CROSS F. CURVE (THRU, ↗, ↘)] selector switch is set to [THRU].

7 Press the [MASTER] button at the center of this unit.

Set so that the [MASTER] button is lit.

- When the [MASTER] button is lit, the audio level output from the [MASTER OUT 1] and [MASTER OUT 2] terminals is displayed on the [LEVEL] indicator.

8 Turn the [MASTER LEVEL] control clockwise.

Sound is output from the speakers.

The [LEVEL] indicator lights.

Adjust the [MASTER LEVEL] control so that the orange indicator lights where the track's volume is highest (at the climax, etc.).

Be careful that the red indicator does not light, or the sound could be distorted.

2 Turn the rotary selector to select [LINK DISCONNECT], then press the rotary selector.

A list of the mobile devices on which rekordbox (iOS/Android) is installed and with which links with this unit are established is displayed on the main unit display.

3 Turn the rotary selector to select the mobile device whose link you want to disconnect, then press the rotary selector.

The link with the selected mobile device is disconnected.

Mixing using the faders

Prepare the unit in advance so that the sound of [CH 1] is being output from the speakers. For instructions on preparation, see *Outputting sound* on page 23.

For instructions on monitoring the sound, see *Monitoring sound with headphones* on page 20.

Mixing using the channel faders

1 Set [CROSS F. CURVE THRU, ㄨ, ㄣ] (the crossfader curve selection switch) to [THRU].

2 Switch the [DECK2, PHONO2/LINE2] selector switch in the [CH 2] section.

3 Turn the [CH 2] [TRIM] control clockwise.

4 Press the [CH2] button.

The sound of [CH 2] is monitored from the headphones.

5 Turn the [HEADPHONES MIXING] control.

This adjusts the balance of the monitor volume between the sound output from the [MASTER OUT 1] and [MASTER OUT 2] terminals (the sound of [CH 1]) and the sound of [CH 2].

6 Operate [DECK2].

While checking the sound over the headphones, adjust the tempo of [CH 2] track to match the tempo of [CH 1] track.

7 While moving the [CH 2] channel fader to the back, move the [CH 1] channel fader to the front.

While checking the sound output from the speakers, operate the channel faders to substitute the sound of [CH 1] with the sound of [CH 2].

Mixing is completed once only the [CH 2] sound is being output from the speakers.

Mixing using the crossfader

1 Set [CROSS F. CURVE THRU, ㄨ, ㄣ] (the crossfader curve selector switch) to [ㄣ] or [ㄨ].

2 Operate [CH 2].

Operate as described in steps 2 to 6 under *Mixing using the channel faders* on page 24.

3 Move the crossfader gradually to the right.

While checking the sound output from the speakers, operate the crossfader to substitute the sound of [CH 1] with the sound of [CH 2].

Mixing is completed once only the [CH 2] sound is being output from the speakers.

Disconnecting links

Links with mobile devices can be disconnected.

- For instructions on disconnecting links with computers, see the Operating Instructions for rekordbox (Mac/Windows).

1 Press the [INFO(UTILITY)] button for over 1 second.

The [UTILITY] screen is displayed.

Advanced Operation

Using the auto mix function

Use this function to automatically play the selected playlist continuously. When the point 30 seconds before the end of the currently playing track is reached, the two tracks are crossfaded (when using the SYNC function) or faded in and out (in other cases), and playback of the next track starts.

- The track following the first track played when the auto mix function was turned on is switched to by cutting in.
- When a track that is not included on the playlist is loaded and played after turning the auto mix function on, repeat playback is set between one or two tracks.
- The auto mix function cannot be used in the following cases:
 - When the [DECK, PHONO/LINE] selector switch on either of the decks is set to [PHONO/LINE].
 - When the sample launch function is being used on either of the decks.
 - When the PC control mode is being used on either of the decks.

Auto mixing playlists on USB devices

1 Press the [AUTO MIX] button.

The auto mix function turns on.

2 Connect the USB device to the USB device insertion slot.

3 Press the [← USB] button.

4 Select the playlist to be auto mixed.

5 Load the tracks on the playlist.

- When the [AUTO MIX] button is pressed again, the auto mix function turns off.

Auto mixing rekordbox (iOS/Android) or rekordbox (Mac/Windows) playlists

1 Press the [AUTO MIX] button.

The auto mix function turns on.

2 Load the tracks from the rekordbox (iOS/Android) or rekordbox (Mac/Windows) playlist.

For instructions on loading tracks from rekordbox (iOS/Android) or rekordbox (Mac/Windows), see *Loading tracks from mobile devices or computers via wireless LAN* on page 22.

- When the [AUTO MIX] button is pressed again, the auto mix function turns off.

Using the sample launch function

This function can be used to load this unit's internal sampled sound sources into the respective decks and play them.

1 Press the [SAMPLE LAUNCH] button.

This unit's internal sampled sound source is loaded into the deck whose button was pressed.

2 Press the [▶/II (PLAY/PAUSE)] button.

The sampled sound source is played.

- Sampled sound sources can be operated using this unit's deck section in the same way as regular tracks.

Selecting the type of this unit's internal sampled sound source

Press the [SAMPLE LAUNCH] button for over 1 second.

A list of this unit's internal sampled sound sources is displayed on the main unit display.

Turn the rotary selector to select the sampled sound source, then press the rotary selector.

The selected sampled sound source is loaded into the deck.

Using the jog drum function

This function can be used to switch to a mode in which sound is output when the jog dial is touched. This enables DJ performances combining sampler functions and scratching.

1 Press the [JOG DRUM] button.

The jog dial indicator lights red.

Switch the jog dial to the jog drum mode.

2 Set a cue point at the point at which the sound you want to use as the sample starts.

For information about setting cue points, see *Setting Cue* on page 16.

3 Press the top of the jog dial.

Playback starts from the set cue point.

When you release the jog dial, playback stops.

- The currently playing sound can be scratched by scratching while touching the jog dial.
When the jog dial is released after scratching, the track returns to the cue point and playback resumes from there.
- It is also possible to use the sound loaded into this unit using the [SAMPLE LAUNCH] button with the jog drum function.

Using the QUANTIZE function

This function can be used to play auto beat loops, apply beat effects, etc., in tempo with the currently playing track based on the track's GRID information as analyzed with rekordbox.

- Music files must be analyzed with rekordbox (Mac/Windows) in advance in order to use the QUANTIZE function. For instructions on analyzing music files with rekordbox (Mac/Windows), also refer to the User's Manual for rekordbox (iOS/Android) or the Operating Instructions for rekordbox (Mac/Windows).
- The QUANTIZE function does not work with the [ROLL] and [ECHO] effects.

Press the [TIME (AUTO CUE, QUANTIZE)] button while pressing the [SHIFT] button.

The QUANTIZE function turns on.

When auto beat loops are played or beat effects are applied, they are played in tempo with the track.

- When the [TIME (AUTO CUE, QUANTIZE)] button is pressed again while pressing the [SHIFT] button, the QUANTIZE function turns off.

Using the SYNC function

This function can be used to automatically synchronize the tempo (BPM) and beat positions on the left and right decks based on the tracks' GRID information as analyzed with rekordbox.

- Music files must be analyzed with rekordbox (Mac/Windows) in advance in order to use the SYNC function. For instructions on analyzing music files with rekordbox (Mac/Windows), also refer to the User's Manual for rekordbox (iOS/Android) or the Operating Instructions for rekordbox (Mac/Windows).
- The following describes the procedure for synchronizing the [DECK2] track to the [DECK1] track.

1 Play a track that has been analyzed with rekordbox on [DECK1].

The deck on which a track that has been analyzed with rekordbox is played first is set as the MASTER for the SYNC function.

2 Play a track that has been analyzed with rekordbox on [DECK2].

3 Press the [SYNC] button for [DECK2].

[DECK2] is synchronized to the tempo (BPM) and beat positions of the track playing on [DECK1].

- When the [SYNC] button is pressed again, the SYNC function turns off.
- Use the procedure below to restore the currently playing track's tempo (BPM) to its original tempo after turning the SYNC function off.
 - First move the tempo slider to the position of the synchronized tempo (BPM), then set it back to the center position.
 - Reload the same track.

Using the DJ software

This unit also outputs the operating data for the buttons and dials in MIDI format. If you connect a computer with a built-in MIDI-compatible DJ software via a USB cable, you can operate the DJ software on this unit. The sound of music files being played on the computer can also be output from the XDJ-AERO.

To use this unit as an audio device, install the driver software on the computer beforehand (page 8). This unit must also be selected in the DJ software's audio output device settings. For details, see your DJ software's operating instructions.

1 Connect the USB port on this unit to your computer.

For instructions on connections, see *Connecting the input/output terminals* on page 10.

2 Press the [MIDI] button.

[MIDI CONTROL] appears on the main unit display.

3 Launch the DJ software.

Communication with the DJ software starts.

The DJ software can be operated using this unit's buttons and controls.

- It may not be possible to use some buttons to operate the DJ software.
- For messages output by this unit, see *List of MIDI Messages* on page 29.

Changing the [MIXER MODE]

There are two types of DJ software mixing modes, one for mixing using an external mixer and one for mixing within the DJ software. On this unit, either mixing mode can be used by changing the [MIXER MODE] setting on the [UTILITY] screen.

1 Press the [INFO(UTILITY)] button for over 1 second.

The [UTILITY] screen is displayed.

2 Turn the rotary selector, select [MIXER MODE], then press the rotary selector.

3 Turn the rotary selector, select the mode you want to set, then press the rotary selector.

- [XDJ-AERO]: The sound is mixed using this unit's mixer section. The DJ software can be operated using this unit's player section.
- [PC]: The sound is mixed within the DJ software. This unit's [MASTER LEVEL] control, [CH1] button and [CH2] button can be used.

Set the DJ software's audio output settings as described below.

MASTER OUT L :PIONEER XDJ AERO 1

MASTER OUT R :PIONEER XDJ AERO 2

MONITOR OUT L :PIONEER XDJ AERO 3

MONITOR OUT R :PIONEER XDJ AERO 4

- To close the [UTILITY] screen, press the [INFO(UTILITY)] button.

About the playback history (HISTORY)

When tracks managed with rekordbox are played, the playback history is registered at [HISTORY].

- The playback history is stored on the playback device.
- The maximum number of tracks that can be recorded is 999.
- The playback history is not recorded if there is not enough free space on the playback device or if the device is write-protected.
- A new [HISTORY] is created each time the power is turned on and off or the USB device is disconnected then reconnected.

Changing the settings

1 Press the [INFO(UTILITY)] button for over 1 second.

The [UTILITY] screen is displayed.

2 Use the rotary selector to change the setting.

- When the [BACK (TOP)] button is pressed, the previous screen reappears.

3 Press the rotary selector.

The changed settings are stored.

- To close the [UTILITY] screen, press the [INFO(UTILITY)] button.

About the auto standby function

When the auto standby function is turned on, the power is automatically set to the standby mode after the set time has passed with all of the conditions below met.

- That none of this unit's buttons or controls are operated.
- That this unit's channel level indicator is not lit.
- That the USB device's recording and playback functions are not in use.
- That no computer is connected to the USB port (type B port) on this unit's rear panel while the [MIDI] button is pressed.

Setting preferences

Options settings	Selection items	Descriptions
WLAN INFORMATION	For details, see <i>List of WLAN INFORMATION items</i> on page 27.	
WLAN SETTING	For details, see <i>List of WLAN SETTING items</i> on page 28.	
LINK DISCONNECT	Disconnected the link with rekordbox on the mobile device or computer.	
MIXER MODE	XDJ-AERO*/PC	Sets the mode for operating DJ software. For details, see <i>Using the DJ software</i> on page 26.
A. CUE LEVEL	-36 dB/-42 dB/-48 dB/-54 dB/-60 dB*/-66 dB/-72 dB/-78 dB	Sets the auto cue level. For instructions on setting, see <i>Changing the auto cue level</i> on page 19.
LANGUAGE	—	The language used for the XDJ-AERO's display can be selected here.
LCD CONTRAST	1 – 3* – 5	Sets the main unit display's contrast.
LCD COLOR	BLUE*/MAGENTA/RED/WHITE	Sets the main unit display's backlight.
LCD INVERSION	NEGATIVE*/POSITIVE	Inverts the main unit display's tone.
AUTO STANDBY	OFF/20 min*/40 min/60 min	Set the time until the standby mode is set. For details, see <i>About the auto standby function</i> on page 27.
LOAD LOCK	ON/OFF*	Sets whether or not new tracks can be loaded on a deck on which a track is playing.
VERSION No.	—	Displays this unit's software version.

*: Setting upon purchase

List of WLAN INFORMATION items

When [MODE] at [WLAN SETTING] is set to [OFF], only [MODE] and [MAC ADDRESS] are displayed.

Item	
MODE	Displays the operation mode of this unit's wireless LAN function.
SSID	When in the access point mode, displays this unit's [SSID]. When in the WLAN client mode, displays the [SSID] only when connected to an access point.
SECURITY ^[1]	Displays the currently set security (encryption) type.
PASSWORD ^[1]	Displays the currently set password.
IP ADDRESS	When in the access point mode, "192.168.1.1" is displayed. When in the WLAN client mode, displays the acquired IP address.
SUBNET MASK	When in the access point mode, "255.255.255.0" is displayed. When in the WLAN client mode, displays the acquired subnet mask.
MAC ADDRESS	Displays this unit's MAC address.

[1] Not displayed in the WLAN client mode.

List of WLAN SETTING items

When [MODE] at [WLAN SETTING] is set to [OFF], only [MODE] and [RESET TO DEFAULT] are displayed.

Setting item 1	Setting item 2	Setting ranges	Description
MODE	—	OFF/ACCESS POINT(AP)*/ WLAN CLIENT	Used to set this unit's operation mode.
INPUT WPS PINCODE ^[1]	—	0 to 9 (max. 8 characters)	When in the access point mode, input the PIN code of the sub unit to be connected to this unit here to authorize connection.
NETWORK SETTING ^[1]	SSID	A to Z, a to z, 0 to 9, symbols (max. 32 characters)	Used to set this unit's [SSID].
	SECURITY	OPEN / WPA / WPA2	Used to set this unit's security (encryption) type.
	PASSWORD	A to Z, a to z, 0 to 9, symbols (max. 64 characters)	Used to set this unit's password.
OTHERS ^[1]	IP ADDRESS		Sets this unit's IP address.
	SUBNET MASK		Sets this unit's subnet mask.
	CHANNEL NO.	CH1~AUTO*	This unit uses the 2.4 GHz band. If there is a wireless LAN network on the same band in the area and the waves cause interference, making connections and communications instable, try changing the channel manually. (By default, this is set to [AUTO] and a relatively free channel is selected automatically.)
	DHCP SERVER	ENABLE*/DISABLE	Used to set whether or not to enable this unit's DHCP server function. [ENABLE]: Enables the DHCP server function. [DISABLE]: Disables the DHCP server function.
	CHANNEL WIDTH	20 MHz*/40 MHz	Used to set the frequency band's width. Only set [40 MHz] when communications are possible by IEEE802.11n. Otherwise leave this at [20 MHz].
	KEY RENEWAL INTERVAL	0minute to 60minute* to 1440minute	When [WPA] or [WPA2] is set at [SECURITY] under [NETWORK SETTING], the encryption key's renewal interval can be set. When this setting is made, the encryption key is renewed automatically at specific intervals, maintaining a more secure status.
	RESET TO DEFAULT	—	YES/NO*
SELECT SSID ^[2]	—	Method of selection + input method	Displays up to 10 receivable networks (SSIDs) in the area. "OTHER" at the bottom is used to specify an [SSID] that is not displayed.
DHCP CLIENT ^[2]	—	ENABLE*/DISABLE	Used to select whether to acquire the network settings automatically using the DHCP function on the connected network side or to set them manually. [ENABLE]: Acquire the IP address, subnet mask, etc., automatically. [DISABLE]: Input the IP address, subnet mask, etc., manually.
IP ADDRESS/SUBNET MASK	—	000:000:000:000 to 255:255:255:255 (Set to 192:168:1:1/255:255:255:0 upon purchase.)	When in the access point mode, the fixed values below are set. IP address: 192.168.1.1 Subnet mask: 255.255.255.0 When [DHCP CLIENT] is set to [DISABLE], the values must be input manually.

*: Setting upon purchase

^[1] Not displayed in the WLAN client mode.

^[2] Items marked "*" are not displayed in the access point (AP) mode.

List of MIDI Messages

Of the 3 bytes in MIDI messages, the first and second bytes are expressed in decimal, the third byte in hexadecimal.

	MIDI channel	MIDI ch. Value
Deck A	1	n=0
Deck B	2	n=1
Deck C	3	n=2
Deck D	4	n=3
Effect A/C	5	n=4
Effect B/D	6	n=5
Mixer	7	n=6

1 Player

SW Name	MIDI message (this unit to computer)						Remarks (dd values)
	When SHIFT button is off			When SHIFT button is on			
Rotary selector (turn)	Bn	64	dd	Bn	65	dd	Difference count value from when previously operated <ul style="list-style-type: none"> Turn clockwise: 1 – (max) 30 Turn counterclockwise: 127 – (min) 98
Rotary selector (press)	9n	66	dd	9n	67	dd	OFF=0, ON=127
BACK button	9n	68	dd	—	—	—	OFF=0, ON=127
TIME/AUTO CUE button	9n	62	dd	9n	63	dd	OFF=0, ON=127
PLAY/PAUSE button	9n	11	dd	9n	71	dd	OFF=0, ON=127
CUE button	9n	12	dd	9n	72	dd	OFF=0, ON=127
AUTO BEAT LOOP control (turn)	Bn	19	dd	9n	79	dd	Difference count value from when previously operated <ul style="list-style-type: none"> Turn clockwise: 1 – (max) 30 Turn counterclockwise: 127 – (min) 98
AUTO BEAT LOOP control (press)	9n	20	dd	9n	80	dd	OFF=0, ON=127
JOG DRUM button	9n	21	dd	—	—	—	OFF=0, ON=127
SAMPLE LAUNCH button	9n	23	dd	—	—	—	OFF=0, ON=127
MASTER TEMPO button	9n	26	dd	9n	86	dd	OFF=0, ON=127
TEMPO RANGE button	9n	27	dd	9n	87	dd	OFF=0, ON=127
SYNC button	9n	88	dd	9n	92	dd	OFF=0, ON=127
TEMPO adjustment control	Bn	0	MSB	Bn	5	MSB	0–16383
	Bn	32	LSB	Bn	37	LSB	0 at – side, 16383 at + side
Jog dial (when outer section turned)	Bn	1	dd	Bn	6	dd	Difference count from previous operation <ul style="list-style-type: none"> Increases from 64 when turned clockwise, decreases from 64 when turned counterclockwise. The cumulative difference count when the jog dial is turned 1 rotation is 1215.
Jog dial (when top section turned)	Bn	2	dd	Bn	7	dd	Difference count from previous operation <ul style="list-style-type: none"> Increases from 64 when turned clockwise, decreases from 64 when turned counterclockwise. The cumulative difference count when the jog dial is turned 1 rotation is 1215.
Jog dial (when top section pressed)	9n	54	dd	9n	103	dd	OFF=0, ON=127

Indicator name	MIDI message (computer to this unit)						Remarks (dd values)	
	When SHIFT button is off			When SHIFT button is on				
PLAY/PAUSE	9n	11	dd	9n	71	dd	Off = 0, lit = 127	
CUE	9n	12	dd	9n	72	dd	Off = 0, lit = 127	
AUTO BEAT LOOP LED	9n	20	dd	9n	80	dd	Off = 0, lit = 127	
JOG DRUM	9n	21	dd	—	—	—	Off = 0, lit = 127	
SAMPLE LAUNCH	9n	23	dd	—	—	—	Off = 0, lit = 127	
MASTER TEMPO	9n	26	dd	9n	86	dd	Off = 0, lit = 127	
SYNC	9n	88	dd	9n	92	dd	Off = 0, lit = 127	
MASTER LED	9n	89	dd	9n	93	dd	Off = 0, lit = 127	
Jog dial illumination (4-point lighting)	Blue	9n	55	dd	9n	56	dd	Off = 0, lit = 127
	Red	9n	57	dd	9n	58	dd	Off = 0, lit = 127



2 Effects

SW Name		MIDI message (this unit to computer)						Remarks (dd values)
		When SHIFT button is off			When SHIFT button is on			
BEAT control	Deck A	B4	0	dd	B4	16	dd	Difference count value from when previously operated • Turn clockwise: 1 – (max) 30 • Turn counterclockwise: 127 – (min) 98
	Deck B	B5	0	dd	B5	16	dd	Difference count value from when previously operated • Turn clockwise: 1 – (max) 30 • Turn counterclockwise: 127 – (min) 98
	Deck C	B4	8	dd	B4	24	dd	Difference count value from when previously operated • Turn clockwise: 1 – (max) 30 • Turn counterclockwise: 127 – (min) 98
	Deck D	B5	8	dd	B5	24	dd	Difference count value from when previously operated • Turn clockwise: 1 – (max) 30 • Turn counterclockwise: 127 – (min) 98
FX SELECT button (TRANS)	Deck A	94	70	dd	94	98	dd	OFF=0, ON=127
	Deck B	95	70	dd	95	98	dd	OFF=0, ON=127
	Deck C	94	74	dd	94	102	dd	OFF=0, ON=127
	Deck D	95	74	dd	95	102	dd	OFF=0, ON=127
FX SELECT button (FLANGER)	Deck A	94	71	dd	94	99	dd	OFF=0, ON=127
	Deck B	95	71	dd	95	99	dd	OFF=0, ON=127
	Deck C	94	75	dd	94	103	dd	OFF=0, ON=127
	Deck D	95	75	dd	95	103	dd	OFF=0, ON=127
FX SELECT button (ECHO)	Deck A	94	72	dd	94	100	dd	OFF=0, ON=127
	Deck B	95	72	dd	95	100	dd	OFF=0, ON=127
	Deck C	94	76	dd	94	104	dd	OFF=0, ON=127
	Deck D	95	76	dd	95	104	dd	OFF=0, ON=127
FX SELECT button (ROLL)	Deck A	94	73	dd	94	101	dd	OFF=0, ON=127
	Deck B	95	73	dd	95	101	dd	OFF=0, ON=127
	Deck C	94	77	dd	94	105	dd	OFF=0, ON=127
	Deck D	95	77	dd	95	105	dd	OFF=0, ON=127
LEVEL/DEPTH	Deck A	B4 B4	2 34	MSB LSB	B4 B4	18 50	MSB LSB	0-16383 'When turned fully counterclockwise: 0 / When turned fully clockwise: 16383
	Deck B	B5 B5	2 34	MSB LSB	B5 B5	18 50	MSB LSB	0-16383 'When turned fully counterclockwise: 0 / When turned fully clockwise: 16383
	Deck C	B4 B4	10 42	MSB LSB	B4 B4	26 58	MSB LSB	0-16383 'When turned fully counterclockwise: 0 / When turned fully clockwise: 16383
	Deck D	B5 B5	10 42	MSB LSB	B5 B5	26 58	MSB LSB	0-16383 'When turned fully counterclockwise: 0 / When turned fully clockwise: 16383

Indicator name		MIDI message (computer to this unit)						Remarks (dd values)
		When SHIFT button is off			When SHIFT button is on			
FX SELECT (TRANS)	Deck A	94	70	dd	94	98	dd	Off = 0, lit = 127
	Deck B	95	70	dd	95	98	dd	Off = 0, lit = 127
	Deck C	94	74	dd	94	102	dd	Off = 0, lit = 127
	Deck D	95	74	dd	95	102	dd	Off = 0, lit = 127
FX SELECT (FLANGER)	Deck A	94	71	dd	94	99	dd	Off = 0, lit = 127
	Deck B	95	71	dd	95	99	dd	Off = 0, lit = 127
	Deck C	94	75	dd	94	103	dd	Off = 0, lit = 127
	Deck D	95	75	dd	95	103	dd	Off = 0, lit = 127
FX SELECT (ECHO)	Deck A	94	72	dd	94	100	dd	Off = 0, lit = 127
	Deck B	95	72	dd	95	100	dd	Off = 0, lit = 127
	Deck C	94	76	dd	94	104	dd	Off = 0, lit = 127
	Deck D	95	76	dd	95	104	dd	Off = 0, lit = 127
FX SELECT (ROLL)	Deck A	94	73	dd	94	101	dd	Off = 0, lit = 127
	Deck B	95	73	dd	95	101	dd	Off = 0, lit = 127
	Deck C	94	77	dd	94	105	dd	Off = 0, lit = 127
	Deck D	95	77	dd	95	105	dd	Off = 0, lit = 127

3 Mixer

SW Name		MIDI message (this unit to computer)						Remarks (dd values)
		When SHIFT button is off		When SHIFT button is on				
TRIM control	Deck A	B6 B6	3 35	MSB LSB	— —	— —	— —	0-16383 When turned fully counterclockwise: 0 / When turned fully clockwise: 16383
	Deck B	B6 B6	4 36	MSB LSB	— —	— —	— —	0-16383 When turned fully counterclockwise: 0 / When turned fully clockwise: 16383
	Deck C	B6 B6	5 37	MSB LSB	— —	— —	— —	0-16383 When turned fully counterclockwise: 0 / When turned fully clockwise: 16383
	Deck D	B6 B6	6 38	MSB LSB	— —	— —	— —	0-16383 When turned fully counterclockwise: 0 / When turned fully clockwise: 16383
EQ [HI] control	Deck A	B6 B6	7 39	MSB LSB	— —	— —	— —	0-16383 When turned fully counterclockwise: 0 / When turned fully clockwise: 16383
	Deck B	B6 B6	8 40	MSB LSB	— —	— —	— —	0-16383 When turned fully counterclockwise: 0 / When turned fully clockwise: 16383
	Deck C	B6 B6	9 41	MSB LSB	— —	— —	— —	0-16383 When turned fully counterclockwise: 0 / When turned fully clockwise: 16383
	Deck D	B6 B6	10 42	MSB LSB	— —	— —	— —	0-16383 When turned fully counterclockwise: 0 / When turned fully clockwise: 16383
EQ [MID] control	Deck A	B6 B6	11 43	MSB LSB	— —	— —	— —	0-16383 When turned fully counterclockwise: 0 / When turned fully clockwise: 16383
	Deck B	B6 B6	12 44	MSB LSB	— —	— —	— —	0-16383 When turned fully counterclockwise: 0 / When turned fully clockwise: 16383
	Deck C	B6 B6	13 45	MSB LSB	— —	— —	— —	0-16383 When turned fully counterclockwise: 0 / When turned fully clockwise: 16383
	Deck D	B6 B6	14 46	MSB LSB	— —	— —	— —	0-16383 When turned fully counterclockwise: 0 / When turned fully clockwise: 16383
EQ [LOW] control	Deck A	B6 B6	15 47	MSB LSB	— —	— —	— —	0-16383 When turned fully counterclockwise: 0 / When turned fully clockwise: 16383
	Deck B	B6 B6	16 48	MSB LSB	— —	— —	— —	0-16383 When turned fully counterclockwise: 0 / When turned fully clockwise: 16383
	Deck C	B6 B6	17 49	MSB LSB	— —	— —	— —	0-16383 When turned fully counterclockwise: 0 / When turned fully clockwise: 16383
	Deck D	B6 B6	18 50	MSB LSB	— —	— —	— —	0-16383 When turned fully counterclockwise: 0 / When turned fully clockwise: 16383
FILTER control	Deck A	B6 B6	27 59	MSB LSB	— —	— —	— —	0-16383 When turned fully counterclockwise: 0 / When turned fully clockwise: 16383
	Deck B	B6 B6	28 60	MSB LSB	— —	— —	— —	0-16383 When turned fully counterclockwise: 0 / When turned fully clockwise: 16383
	Deck C	B6 B6	29 61	MSB LSB	— —	— —	— —	0-16383 When turned fully counterclockwise: 0 / When turned fully clockwise: 16383
	Deck D	B6 B6	30 62	MSB LSB	— —	— —	— —	0-16383 When turned fully counterclockwise: 0 / When turned fully clockwise: 16383
Channel fader	Deck A	B6 B6	19 51	MSB LSB	— —	— —	— —	0-16383 0 at lower limit, 16383 at upper limit
	Deck B	B6 B6	21 53	MSB LSB	— —	— —	— —	0-16383 0 at lower limit, 16383 at upper limit
	Deck C	B6 B6	23 55	MSB LSB	— —	— —	— —	0-16383 0 at lower limit, 16383 at upper limit
	Deck D	B6 B6	25 57	MSB LSB	— —	— —	— —	0-16383 0 at lower limit, 16383 at upper limit

SW Name		MIDI message (this unit to computer)						Remarks (dd values)
		When SHIFT button is off			When SHIFT button is on			
HEADPHONES MIXING control		B6 B6	1 33	MSB LSB	— —	— —	— —	0-16383 When turned fully counterclockwise: 0 / When turned fully clockwise: 16383
HEADPHONES LEVEL control		B6 B6	2 34	MSB LSB	— —	— —	— —	0-16383 When turned fully counterclockwise: 0 / When turned fully clockwise: 16383
HEADPHONE CUE	Deck A	96	84	dd	—	—	—	OFF=0, ON=127
	Deck B	96	85	dd	—	—	—	OFF=0, ON=127
	Deck C	96	86	dd	—	—	—	OFF=0, ON=127
	Deck D	96	87	dd	—	—	—	OFF=0, ON=127
MIC ATT. control		B6 B6	20 52	MSB LSB	— —	— —	— —	0-16383 When turned fully counterclockwise: 0 / When turned fully clockwise: 16383
MIC EQ control		B6 B6	22 54	MSB LSB	— —	— —	— —	0-16383 When turned fully counterclockwise: 0 / When turned fully clockwise: 16383
MIC (ON/OFF) button		96	70	dd	—	—	—	OFF=0, ON=127
MASTER VOL control		B6 B6	0 32	MSB LSB	— —	— —	— —	0-16383 When turned fully counterclockwise: 0 / When turned fully clockwise: 16383
Crossfader		B6 B6	31 63	MSB LSB	— —	— —	— —	0-16383 0 at lower limit, 16383 at upper limit
Crossfader curve	THRU	96	65	dd	—	—	—	OFF=0, ON=127
		96	66	dd	—	—	—	OFF=0, ON=127
		96	67	dd	—	—	—	OFF=0, ON=127
MASTER button		96	68	dd	—	—	—	OFF=0, ON=127
AUTO MIX button		96	69	dd	—	—	—	OFF=0, ON=127

Indicator name		MIDI message (computer to this unit)						Remarks (dd values)
		When SHIFT button is off			When SHIFT button is on			
CH LEVER METER	Deck A	B6	71	dd	—	—	—	0 to 127 All off = 0, all on = 127
	Deck B	B6	72	dd	—	—	—	0 to 127 All off = 0, all on = 127
	Deck C	B6	73	dd	—	—	—	0 to 127 All off = 0, all on = 127
	Deck D	B6	74	dd	—	—	—	0 to 127 All off = 0, all on = 127
HEADPHONE CUE	Deck A	96	84	dd	—	—	—	Off = 0, lit = 127
	Deck B	96	85	dd	—	—	—	Off = 0, lit = 127
	Deck C	96	86	dd	—	—	—	Off = 0, lit = 127
	Deck D	96	87	dd	—	—	—	Off = 0, lit = 127
AUTO MIX button		96	69	dd	—	—	—	Off = 0, lit = 127

Additional information

Troubleshooting

- Incorrect operation is often mistaken for trouble or malfunction. If you think that there is something wrong with this component, check the points below. Sometimes the trouble may lie in another component. Inspect the other components and electrical appliances being used. If the trouble cannot be rectified after checking the items below, ask your nearest Pioneer authorized service center or your dealer to carry out repair work.
- This unit may not operate properly due to static electricity or other external influences. In this case, proper operation may be restored by turning the power off, waiting 1 minute, then turning the power back on.

Power supply

Problem	Check	Remedy
The power is not turned on.	Is the power cord properly connected?	Plug in the power cord to an AC outlet. (page 10)
None of the indicators light.	Is the [STANDBY/ON] switch for power supply set to [ON] ?	Set the [STANDBY/ON] switch for power supply to [ON] . (page 15)
The [STANDBY/ON] indicator flashes and the power does not turn on.	—	Normal operation can sometimes be restored by unplugging the power cord, waiting at least 1 minute, then plugging the power cord back in. If the symptom persists, unplug the power cord and request repairs.

Audio output

Problem	Check	Remedy
No sound or small sound.	Are the [DECK1, PHONO1/LINE1] and [DECK2, PHONO2/LINE2] selector switches set to the proper positions?	Switch the channel's input source using the [DECK1, PHONO1/LINE1] and [DECK2, PHONO2/LINE2] selector switches. (Page 23)
	Are the [TRIM] control, channel faders, crossfader and [MASTER LEVEL] control set to the proper positions?	Set the [TRIM] control, channel faders, crossfader and [MASTER LEVEL] control to the proper positions. (Page 23)
	Is the [LINE, PHONO] selector switch on this unit's rear panel properly set?	Properly set the [LINE, PHONO] selector switch on this unit's rear panel according to the connected device. (page 10)
Distorted sound.	Is the [MASTER LEVEL] control set to the proper position?	Adjust [MASTER LEVEL] so that the orange indicator on the master level indicator lights at the peak level. (Page 23)
	Is the [TRIM] control set to the proper position?	Adjust [TRIM] so that the orange indicator on the channel level indicator lights at the peak level. (Page 23)
	Is the [LINE, PHONO] selector switch on this unit's rear panel properly set?	Properly set the [LINE, PHONO] selector switch on this unit's rear panel according to the connected device. (page 10)
	Is the sound level input to the [MIC] terminal set to an appropriate level?	Set the audio level input to the terminals to a suitable level for the connected devices.
No sound is produced, or sound is distorted or noisy.	Is this unit placed near a TV?	Turn the TV's power off or install this unit and TV away from each other.
Microphone sound is not output or volume is low.	Are the [MIC ATT.] and [MIC LEVEL] controls set to the proper positions?	Set the [MIC ATT.] and [MIC LEVEL] controls to the proper positions.
Sound is distorted when an analog player is connected to this unit's [PHONO/LINE] terminals. Or, lighting of the channel level indicator does not change even when the [TRIM] control is turned.	Have you connected an analog player with a built-in phono equalizer?	For analog players with built-in phono equalizers, use with the [LINE, PHONO] selector switch on this unit's rear panel switched to [LINE] . (page 10) If the analog player with built-in phono equalizer has a PHONO/LINE selector switch, switch it to PHONO.
	Is an audio interface for computers connected between the analog player and this unit?	If the output of the audio interface for computers is line level, use with the [LINE, PHONO] selector switch on this unit's rear panel switched to [LINE] . (page 10) If the analog player has a PHONO/LINE selector switch, switch it to PHONO.

Display

Problem	Check	Remedy
The playing address display is not displayed in the remaining time mode.	—	When playing files recorded in VBR, it may happen that the set cannot detect the length of the track immediately and that some time is required for the playing address display to appear.
The category is not displayed.	Is the rekordbox (Mac/Windows) library information stored on the USB device?	Use a device onto which the library information has been exported from rekordbox (Mac/Windows).
	Is the USB device write-protected?	Cancel the USB device's write-protection so that this unit can write on it.
Caching meter is not displayed.	Are you playing a track from a USB device?	The caching meter is not displayed when playing tracks from USB devices.
	Is a track over 10 minutes in length loaded?	The caching meter is not displayed when tracks over 10 minutes in length are loaded.
	Is a WAV file loaded?	—
Nothing is displayed.	Is the auto standby function activated?	This unit is shipped with the auto standby function turned on. If you do not want to use the auto standby function, set [AUTO STANDBY] to [OFF] . (page 27)

Functions and operations

Problem	Check	Remedy
Can't crossfade.	Is the [CROSS F. CURVE (THRU, ↗, ↘)] (cross-fader curve selector) switch set to [THRU] ?	Set the [CROSS F. CURVE (THRU, ↗, ↘)] (crossfader curve selector) switch to a position other than [THRU] . (Page 23)
Back cue function does not work.	Is a cue point set?	Set a cue point. (page 16)
No effect.	Is one of the [FX SELECT] buttons (TRANS, FLANGER, ECHO or ROLL) pressed?	Press one of the [FX SELECT] buttons (TRANS, FLANGER, ECHO or ROLL). (page 21)
	Is the [LEVEL/DEPTH] control set to the center position?	Turn the [LEVEL/DEPTH] control clockwise or counterclockwise. (page 21)
	Is the [BEAT] control set to the proper position?	Set the [BEAT] control to the proper position. (page 21)
[SYNC] function does not work.	Has the music file been analyzed?	Analyze the file. (page 26)
[SYNC] function does not work even when files are analyzed.	Is the beat grid irregular?	Set the beat grid properly. (page 26)
	Is the beat grid properly tapped?	
	Are the BPMs of the tracks in the two decks too different?	The [SYNC] function will not work properly if the BPM of the track on the deck for which the [SYNC] button is pressed is outside the adjustable tempo range of the track on the deck for which the [SYNC] button is not pressed.
Recording is not possible.	Are you scratching?	The [SYNC] function is disabled when scratching.
	Is the external device or microphone properly connected?	Check the connection of the external device or microphone. (page 10)
Auto mixing is not possible.	Is the channel you want to record properly selected?	Select the channel you want to record properly.
	Is a track on a playlist selected?	Select a track on a playlist.
	Are there at least two playable tracks on the playlist?	Put at least two playable tracks on the playlist.
Settings are not stored in the memory.	Are the [DECK1, PHONO1/LINE1] and [DECK2, PHONO2/LINE2] selector switches set to the proper positions?	When the [DECK1, PHONO1/LINE1] and [DECK2, PHONO2/LINE2] selector switches are set to the [PHONO/LINE] side, the auto mixing function cannot be used. Set both selector switches to the [DECK] side. (page 25)
	Has the power been turned off directly after changing the setting?	After changing settings, wait at least 10 seconds before turning the power off.

USB devices

Problem	Check	Remedy
USB device is not recognized.	Is the USB device properly connected?	Connect the device securely (all the way in).
	Is the USB device connected via a USB hub?	USB hubs cannot be used.
	Is the USB device supported by this unit?	This unit supports such USB mass storage class USB devices as external hard disks and portable flash memory devices.
	Is the file format supported by this unit?	Check the file format of the connected USB device. For the file formats supported by this unit, see <i>Playable USB devices</i> on page 5.
	Are you using a USB device (such as a bus power-driven hard disk) whose current is higher than this unit's rated current (500 mA)?	Use a USB device within this unit's rated current (such as a hard disk driven by an AC adapter or other external power supply).
Time is required to read USB devices (flash memory drives and hard discs).	—	Turn the power off, wait 1 minute, then turn the power back on.
	Is there a large number of folders or files recorded on the USB device?	When there are many folders or files, some time may be required for loading.
Playback does not start when a track is loaded from a USB device.	Are files other than music files stored on the USB device?	When files other than music files are stored in folders, time is required to read them as well. Do not store files or folders other than music files on the USB device.
	Are the files playable?	See <i>Playable music file formats</i> on page 5.
No sound is produced or the sound is faint when playing a track recorded on a USB device.	Is the auto cue function activated?	Press the [TIME(AUTO CUE, QUANTIZE)] button for over 1 second to cancel the auto cue function. (page 19)
	Is the [MASTER LEVEL] control set to the proper position?	Adjust the [MASTER LEVEL] control so that the master level indicator's orange indicator lights at the peak level before recording. (Page 23)
Sound is distorted when playing a track recorded on a USB device.	Is the [TRIM] control set to the proper position?	Adjust the [TRIM] control so that the channel level indicator's orange indicator lights at the peak level before recording. (Page 23)
File cannot be played.	Is the file copyright-protected (by DRM)?	Copyright-protected files cannot be played.
Music files cannot be played.	Are the music files damaged?	Play music files that are not damaged.

DJ software

Problem	Check	Remedy
DJ software on a computer cannot be operated.	Is the driver software properly set?	Set the driver software properly. (Page 8)
DJ software's sound is not properly output.	Are the DJ software's output settings and this unit's [MIXER MODE] setting properly set?	Check the DJ software's settings, then check this unit's settings on the [UTILITY] screen and set the proper signal path. (page 26)
Sound of the DJ software is not output.	Are the connection cables properly connected?	Connect the connection cables properly. (page 10)
	Is the included USB cable properly connected?	Connect the computer and this unit directly using the included USB cable. USB hubs cannot be used. (page 10)
	Are terminals or plugs dirty?	Wipe any dirt off terminals and plugs before connecting.
	Are the connected components and amplifiers properly set?	Set the external input selection and volume on the components and amplifiers properly.
	Is this unit's [MIXER MODE] properly set?	Set this unit's [MIXER MODE] according to the DJ software's audio output settings. (page 26)
Sound being played is interrupted when using DJ software.	Is the driver software's latency value suitable?	Set the driver software's latency to a suitable value. (Page 8)
		Set the DJ software's latency to a suitable value.

Wireless LAN

Problem	Check	Remedy
Tracks cannot be loaded via wireless connection.	Is the wireless LAN connection properly connected?	Connect the mobile device or computer and this unit properly by wireless LAN. (page 11)
	Is the link established?	For instructions on establishing the link, see the User's Manual for rekordbox (iOS/Android) or the Operating Instructions for rekordbox (Mac/Windows).
	Are over four mobile devices or computers connected?	The maximum total number of units (computer and/or mobile devices) that can be connected simultaneously is four. Disconnect unnecessary connections at [LINK DISCONNECT] on the [UTILITY] screen. (page 24)
	Is the [LOAD LOCK] function on?	Set [LOAD LOCK] on the [UTILITY] screen to [OFF] , or pause the currently playing track before loading. (page 27)
Links cannot be established.	Is the wireless LAN connection properly connected?	Connect the mobile device or computer and this unit properly by wireless LAN. (page 11)
	Are over four mobile devices or computers connected?	The maximum total number of units (computer and/or mobile devices) that can be connected simultaneously is four. Disconnect unnecessary connections at [LINK DISCONNECT] on the [UTILITY] screen. (page 24)
Track loading does not finish or is slow. Jog dial indicator does not stop flashing.	Is the wireless LAN connection properly connected?	Connect the mobile device or computer and this unit properly by wireless LAN. (page 11)
	Is the link established?	For instructions on establishing the link, see the User's Manual for rekordbox (iOS/Android) or the Operating Instructions for rekordbox (Mac/Windows).
	Are 2 tracks being loaded simultaneously? Is the device to which you are trying to transfer the track far away? Are other wireless signals being used nearby?	In these cases, track loading may be slow.
Loop playback starts suddenly on tracks loaded via wireless LAN.	Is the wireless LAN connection properly connected?	The wireless LAN connection may have been cut. Check the connection status. (Emergency loop function)
Connection with mobile device is not possible, mobile device cannot be operated or no sound is produced.	Is there a device producing electromagnetic waves in the 2.4 GHz band (microwave oven, other wireless LAN device, etc.) nearby?	Either install this unit away from the device producing electromagnetic waves or stop using the device producing electromagnetic waves.
	Are the mobile device and this unit too far apart or is there an obstacle between them?	Install in the same room within a line-of-sight distance (with no obstacles) of 40 meters. (This line-of-sight distance is rough indication. The actual distance at which communications are possible may differ, depending on the surrounding environment.)

Error messages

When this unit cannot operate normally, an error code appears on the display. Check the table below and take the measures indicated. If an error code not shown on the table below is displayed, or if the same error code is displayed again after taking the indicated action, contact your store of purchase or a nearby Pioneer service station.

Error code	Error type	Description of error	Cause and action
E-8304	DECODE ERROR	Music files that cannot be played normally are loaded.	The music files are not in an authorized format. Replace them with music files in an authorized format.
E-8305	DATA FORMAT ERROR		
E-8306	NO FILE	Track recorded in the library, playlist, etc., has been deleted from the USB device and cannot be played.	To play the track, load it back onto the USB device.

Block Diagram

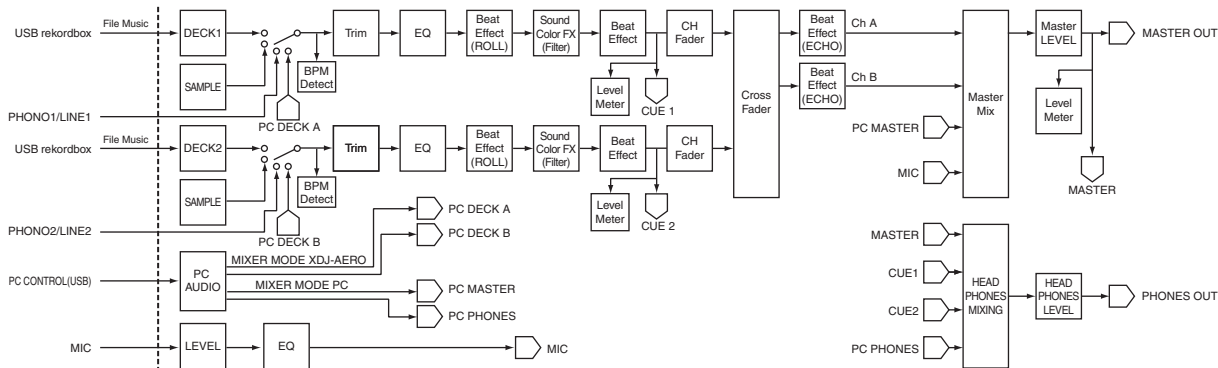

List of icons displayed on the main unit display section

	Genre		Playback is not possible
	Artist		Playing
	Album		Played
	Track/file name		Folder
	Playlist History		Remixer
	Rating		Original artist
	Time		rekordbox

About trademarks and registered trademarks

- Pioneer and rekordbox are trademarks or registered trademarks of the PIONEER CORPORATION.
 - Microsoft®, Windows Vista®, Windows® and Internet Explorer® are either registered trademarks or trademarks of Microsoft Corporation in the United States and/or other countries.
 - Apple, Macintosh, Mac OS, Safari, iTunes and Finder are registered trademarks of Apple Inc. in the United States and other countries.
 - Android and Google Play are trademarks of Google Inc.
 - Intel and Pentium are trademarks of Intel Corporation in the U.S. and other countries.
 - ASIO is a trademark of Steinberg Media Technologies GmbH.
- The names of companies and products mentioned herein are the trademarks of their respective owners.

This product has been licensed for nonprofit use. This product has not been licensed for commercial purposes (for profit-making use), such as broadcasting (terrestrial, satellite, cable or other types of broadcasting), streaming on the Internet, Intranet (a corporate network) or other types of networks or distributing of electronic information (online digital music distribution service). You need to acquire the corresponding licenses for such uses. For details, see <http://www.mp3licensing.com>.

Cautions on copyrights

rekordbox restricts playback and duplication of copyright-protected music contents.

- When coded data, etc., for protecting the copyright is embedded in the music contents, it may not be possible to operate the program normally.
- When rekordbox detects that coded data, etc., for protecting the copyright is embedded in the music contents, processing (playback, reading, etc.) may stop.

Recordings you have made are for your personal enjoyment and according to copyright laws may not be used without the consent of the copyright holder.

- Music recorded from CDs, etc., is protected by the copyright laws of individual countries and by international treaties. It is the full responsibility of the person who has recorded the music to ensure that it is used legally.
- When handling music downloaded from the Internet, etc., it is the full responsibility of the person who has downloaded the music to ensure that it is used in accordance with the contract concluded with the download site.

Using the online support site

Before making inquiries on rekordbox operating procedures or technical issues, read the rekordbox operating instructions and online manual and check the FAQ provided on the rekordbox online support site.

<rekordbox online support site>

<http://rekordbox.com>

- User registration on the rekordbox online support site is required prior to making inquiries concerning rekordbox.
- You will need to enter your license key during user registration, so please have it handy. Also, be sure not to forget the login name (your e-mail address) and the password specified for your user registration, as well as the license key.
- PIONEER CORPORATION collects your personal information for the following purposes:
 - 1 To provide customer support for your purchased product
 - 2 To inform you of product or event information by e-mail
 - 3 To obtain feedback collected by survey for product planning purposes
 - Your personal information is kept confidential corresponding to the privacy policy set forth by our company.
 - Pioneer's privacy policy can be viewed on the rekordbox online support site.
- When making inquiries regarding rekordbox, please be sure to furnish your computer type and specifications (CPU, installed memory, other connected peripherals, etc.), the operating system and version used, as well as concrete information regarding the issue at hand.
 - To inquire about configuring your computer with non-Pioneer peripheral devices and to obtain the corresponding technical support, contact the specific manufacturer or retailer.
- Further version updates are anticipated for improved functionality and performance of rekordbox. Update programs will be available for download on the rekordbox online support site. We strongly recommend you perform these updates and always use the latest version of rekordbox.
- The software screens used in these operating instructions are from the development stage and may differ from the actual screens.

Specifications

AC adapter

Power.....	AC 100 V to 240 V, 50 Hz/60 Hz
Rated current	0.6 A
Rated output.....	DC 12 V, 2 A
Power consumption (standby)	0.5 W

General – Main Unit

Power consumption.....	1.3 A
Main unit weight	3.7 kg
Max. external dimensions	623 mm (W) x 65 mm (H) x 289.5 mm (D)
Tolerable operating temperature	+5 °C to +35 °C
Tolerable operating humidity	5 % to 85 % (no condensation)

Wireless LAN section

Supported standards.....	IEEE 802.11b/g/n (2.4 GHz band)
--------------------------	---------------------------------

Audio Section

Sampling rate.....	44.1 kHz
A/D, D/A converter.....	24 bits
Frequency characteristic	
WLAN/USB/LINE	20 Hz to 20 kHz
S/N ratio (MASTER OUT 1 , rated output, A-WEIGHTED)	
WLAN/USB (when external input terminal not connected)	105 dB
LINE	94 dB
PHONO	84 dB
MIC	79 dB
Total harmonic distortion (MASTER OUT 1 , 20 Hz — 20 kHzBW)	
WLAN/USB	0.003 %
LINE	0.006 %
Standard input level / Input impedance	
LINE	-12 dBu/47 kΩ
PHONO	-52 dBu/47 kΩ

MIC	-52 dBu/12 kΩ
Standard output level / Load impedance / Output impedance	
MASTER OUT 1	+6 dBu/10 kΩ/1 kΩ or lower
MASTER OUT 2	+2 dBu/10 kΩ/1 kΩ or lower
PHONES	+3.8 dBu/32 Ω/51 Ω
Rated output level / Load impedance	
MASTER OUT 1	+24 dBu/10 kΩ
MASTER OUT 2	+20 dBu/10 kΩ
Crosstalk (20 Hz — 20 kHzBW)	
LINE	89 dB
Channel equalizer characteristic	
HI	-∞ to +9 dB (13 kHz)
MID	-∞ to +9 dB (1 kHz)
LOW	-∞ to +9 dB (70 Hz)
Microphone equalizer characteristic	
LOW — CENTER — HI	-12 dB (10 kHz) to 0 dB to -12 dB (100 Hz)

Input/output terminals

USB downstream port	
Type A	1 set
Power supply.....	5 V/500 mA or less
USB upstream port	
B type.....	1 set
MASTER OUT 1 output terminal	
TRS phone jack (Ø 6.3 mm).....	1 set
MASTER OUT 2 output terminal	
RCA pin jacks.....	1 set
PHONES output terminal	
Stereo phone jack (Ø 6.3 mm)	1 set
Stereo mini phone jack (Ø 3.5 mm)	1 set
PHONO/LINE input terminals	
RCA pin jack.....	2 sets
MIC input terminal	
Phone jack (Ø 6.3 mm)	1 set
— The specifications and design of this product are subject to change without notice.	

- © 2012 PIONEER CORPORATION.

All rights reserved.

PIONEER CORPORATION

1-1, Shin-ogura, Saiwai-ku, Kawasaki-shi, Kanagawa 212-0031, Japan
<DRI1063-A>