

VIRTUBE VT100FXH/VT100FX/VT250FX/VT50FX

User Manual

A50-45733-00003

en



www.behringer.com



Important Safety Instructions





This symbol, wherever it appears, alerts you to the presence of uninsulated dangerous voltage inside the enclosure - voltage that may be sufficient to constitute a risk of shock.



This symbol, wherever it appears, alerts you to important operating and maintenance instructions in the accompanying literature. Please read the manual.

Caution

-  To reduce the risk of electric shock, do not remove the top cover (or the rear section). No user serviceable parts inside. Refer servicing to qualified personnel.
-  To reduce the risk of fire or electric shock, do not expose this appliance to rain and moisture. The apparatus shall not be exposed to dripping or splashing liquids and no objects filled with liquids, such as vases, shall be placed on the apparatus.
-  These service instructions are for use by qualified service personnel only. To reduce the risk of electric shock do not perform any servicing other than that contained in the operation instructions. Repairs have to be performed by qualified service personnel.

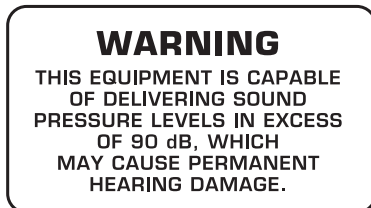

- 1) Read these instructions.
- 2) Keep these instructions.
- 3) Heed all warnings.
- 4) Follow all instructions.
- 5) Do not use this apparatus near water.
- 6) Clean only with dry cloth.
- 7) Do not block any ventilation openings. Install in accordance with the manufacturer's instructions.
- 8) Do not install near any heat sources such as radiators, heat registers, stoves, or other apparatus (including amplifiers) that produce heat.
- 9) Do not defeat the safety purpose of the polarized or grounding-type plug. A polarized plug has two blades with one wider than the other. A grounding-type plug has two blades and a third grounding prong. The wide blade or the third prong are provided for your safety. If the provided plug does not fit into your outlet, consult an electrician for replacement of the obsolete outlet.
- 10) Place the power cord so that it is protected from being walked on and sharp edges. Be sure that the power cord is protected particularly at plugs, convenience receptacles and the point where it exits from the apparatus.
- 11) The apparatus shall be connected to a MAINS socket outlet with a protective earthing connection.
- 12) Where the MAINS plug or an appliance coupler is used as the disconnect device, the disconnect device shall remain readily operable.
- 13) Only use attachments/accessories specified by the manufacturer.
- 14) Use only with the cart, stand, tripod, bracket, or table specified by the manufacturer, or sold with the apparatus. When a cart is used, use caution when moving the cart/apparatus combination to avoid injury from tip-over.
- 15) Unplug this apparatus during lightning storms or when unused for long periods of time.
- 16) Refer all servicing to qualified service personnel. Servicing is required when the apparatus has been damaged in any way, such as power supply cord or plug is damaged, liquid has been spilled or objects have fallen into the apparatus, the apparatus has been exposed to rain or moisture, does not operate normally, or has been dropped.



Foreword



Dear Customer,
Welcome to the team of VIRTUBE users, and thank you very much for expressing your confidence in us by purchasing this device.

Writing this foreword for you gives me great pleasure, because it represents the culmination of many months of hard work delivered by our engineering team to achieve a very ambitious goal: to present you with an extraordinary guitar amp that gives you a maximum of flexibility and performance with its modern sound and wealth of functions. The task of

designing our new product certainly meant a great deal of responsibility, which we assumed by focusing on you, the discerning user and musician.

Meeting your expectations also meant a lot of work and night shifts. But it was fun, too. Developing a product usually brings a lot of people together. What a great feeling it is when all who participated in such a project can be proud of what they've achieved.

It is our philosophy to share our enjoyment with you, because you are the most important member of the BEHRINGER team. With your highly competent suggestions for new products you've made a significant contribution to shaping our company and making it successful. In return, we guarantee you uncompromising quality as well as excellent technical and audio properties at an extremely reasonable price. All of this will enable you to give free rein to your creativity without being hampered by budget constraints.

We are often asked how we manage to produce such high-quality devices at such unbelievably low prices. The answer is quite simple: it's you, our customers! Many satisfied customers mean large sales volumes, enabling us to get better purchasing terms for components, etc. Isn't it only fair to pass this benefit on to you? Because we know that your success is our success too!

I would like to thank everyone who has made the VIRTUBE possible. From the developers to the many other employees at this company, each has made a personal contribution to you, the BEHRINGER user.

My friends, it's been worth the effort!

Thank you very much,

Uli Behringer

Table of contents

1. INTRODUCTION	4
1.1 Before you get started	4
1.1.1 Online Registration	4
2. Control elements	5
2.1 Front panel	5
2.1.1 CLEAN CHANNEL	5
2.1.2 OVERDRIVE CHANNEL	5
2.1.3 DIGITAL FX	5
2.1.4 MASTER section	5
2.2 Rear panel	6
2.2.1 FX LOOP	6
3. APPLICATION EXAMPLES	6
3.1 Set-up for practicing with playbacks	6
3.2 Recording set-up with effects device	7
3.3 Live set-up with external speaker box	7
3.4 Wiring the VT100FXH	8
4. Installation	8
5. Specifications	9
6. Warranty	10

1. INTRODUCTION

Congratulations! With the VIRTUBE, you have the newest generation of guitar amps. It offers an extremely broad range of options and possibilities, the only limit being your own creativity. The VIRTUBE is an allrounder with so many features that you hardly need any other equipment.





The demands placed on a guitar amp are nowadays very broad. A guitarist should offer a wide array of sounds. That's why it is very important to us to be able to offer you maximum sound diversity as well as a variety of connection possibilities with your VIRTUBE. Don't worry: you will quickly master the VIRTUBE and learn how to use all of its capabilities easily and intuitively. With its up-to-date circuitry, the VIRTUBE features the functionality and reliability of a truly modern guitar amp.

VTC Virtual Tube Circuitry

The specially developed VTC Virtual Tube Circuitry gives your sound the unique vintage flavor of classic tube amps.

1.1 Before you get started

Your product was carefully packed at the factory to ensure safe transport. Nevertheless, if the box is damaged inspect the unit immediately for signs of damage.

-  **If the unit is damaged please do NOT return it to us, but notify your dealer and the shipping company immediately; otherwise, claims for damage or replacement may not be granted.**
-  **Otherwise, always use the original box to prevent damage during storage or transport.**
-  **Make sure that children cannot play unsupervised with the unit or its packaging.**
-  **Please ensure proper disposal of all packing materials. Recycle whenever possible.**

Ensure adequate air supply and to avoid overheating do not place the unit near radiators etc.

-  **Please make sure that all devices are properly grounded/earthed. For your own safety, never remove or disable the ground/earth conductors from the devices or on the power cords. The unit must always be connected to the mains outlet with a protective grounding connection.**

1.1.1 Online Registration



Please register your new BEHRINGER equipment right after your purchase by visiting www.BEHRINGER.com and read the terms and conditions of our warranty carefully.

Should your BEHRINGER product malfunction, it is our intention to have it repaired as quickly as possible. To arrange for warranty service, please contact the retailer from whom the equipment was purchased. Should your BEHRINGER dealer not be located in your vicinity, you may directly contact one of our subsidiaries. Corresponding contact information is included in the original equipment packaging (Global Contact Information/European Contact Information).

Should your country not be listed, please contact the distributor nearest you. A list of distributors can be found in the support area of our website. Registering your purchase and equipment with us helps us process your repair claims more quickly and efficiently.

Thank you for your cooperation!

* For customers of the EU, different designations can be applied. Customers from the EU get further informations from BEHRINGER Support Germany.

-  **The tone quality may diminish within the range of powerful radio broadcasting stations and high-frequency sources. Increase the distance between the transmitter and the unit, and use shielded cables for all connections.**
-  **We would like to draw your attention to the fact that extremely loud sound levels may damage your hearing as well as your headphones. Turn the MASTER LEVEL control fully to the left before you switch on the unit. Make sure you select a suitable volume at all times.**

2. Control elements

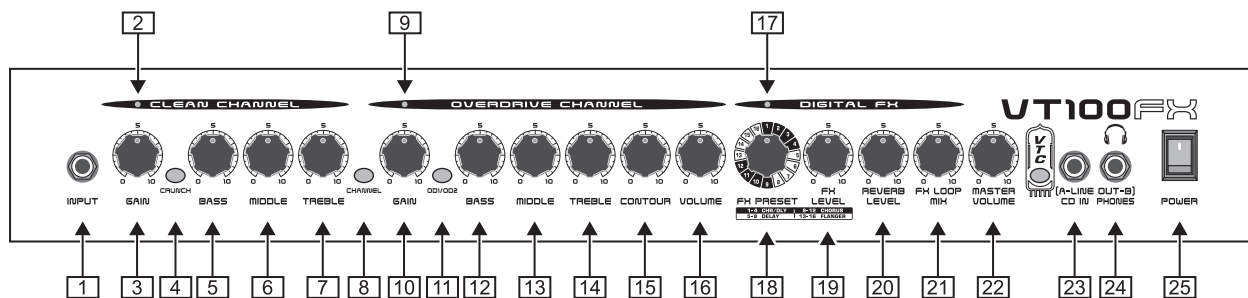

Fig. 2.1: VIRTUBE control elements (front panel)

2.1 Front panel

- [1] The **INPUT** socket is the 1/4" connector for your guitar. Please use a standard 1/4" TS connector.

2.1.1 CLEAN CHANNEL

- [2] The **CLEAN CHANNEL** LED lights up when the CLEAN channel is active.
- [3] The **GAIN** control determines the volume of the CLEAN channel.
- [4] The **CRUNCH** button (VT100FXH and VT100FX only) allows you to add some slight distortion to your clean sound, giving it a bit of "dirt" or "crunch".
- [5] The **BASS** control in the EQ section allows you to raise or lower the bass frequencies on the CLEAN channel.
- [6] With the **MIDDLE** control you can raise or lower the midrange frequencies on the CLEAN channel.
- [7] The **TREBLE** control adjusts the treble frequencies on the CLEAN channel.
- [8] Press the **CHANNEL** button to switch between the CLEAN and OVERDRIVE channels. The channel LED lights up when the channel is activated. With all models you can also switch between channels using the footswitch provided.

2.1.2 OVERDRIVE CHANNEL

- [9] The **OVERDRIVE CHANNEL** LED lights up when the channel is active.
- [10] The **GAIN** control determines the amount of gain applied and hence the degree of distortion in the OVERDRIVE channel.
- [11] The **OD1/OD2** button (VT100FXH and VT100FX only) switches between two different overdrive sounds.
- [12] The **BASS** control in the EQ section allows you to raise or lower the bass frequencies on the OVERDRIVE channel.
- [13] With the **MIDDLE** control (VT100FXH and VT100FX only) you can raise or lower the midrange frequencies on the OVERDRIVE channel.
- [14] The **TREBLE** control adjusts the treble frequencies on the OVERDRIVE channel.
- [15] Use the **CONTOUR** control for additional, highly characteristic adjustment of the midrange, allowing you to easily create traditional as well as ultra-modern guitar sounds.
- [16] The **VOLUME** control adjusts the volume level of the OVERDRIVE channel.

2.1.3 DIGITAL FX

- [17] The **DIGITAL FX** LED lights up when the effects processor is active.
- [18] Use the **FX PRESET** control to select one of 16 effects.

Preset	FX
1 - 4	Chorus/Delay
5 - 8	Delay
9 - 12	Chorus
13 - 16	Flanger

Tab. 2.1: Effects

- [19] The **FX LEVEL** control adjusts the mix ratio between the original and the effect signal.
- [20] The **REVERB LEVEL** control determines the effect intensity of the additional reverb effect.
- [21] The **FX LOOP MIX** control (VT100FXH and VT100FX only) determines the effect intensity of the external effect (see Chapter 2.2.1 FX LOOP).

2.1.4 MASTER section

- [22] The **MASTER VOLUME** control adjusts both the overall volume and the line out/headphones volume.
- [23] The **CD IN** connector allows you to connect the output signal of a CD player, tape deck, or CD/MD walkman. For example, you can play back music CDs or CDs accompanying a guitar tutor while practising. This connector can also be used as a **LINE OUT** output. In this case, the guitar signal is output with no speaker simulation applied and can be routed to an external amp or mixing console. This will not mute the VIRTUBE's built-in loudspeaker.
- [24] The **LINE OUT/PHONES** jack is for headphones connection. Internal speaker simulation is applied to the headphones signal in order to produce an authentic signal. The VIRTUBE's built-in loudspeaker is muted when this connector is used.
- The headphones output signal can also be routed to a mixing console or other sound reinforcement system. To do so, connect the headphones output with the line input on the mixing console. Use a standard cable with 1/4" TS connectors. If hum problems occur, you could insert a DI box, e.g. BEHRINGER ULTRA-DI DI100 or DI120.**
- Some headphones tend to produce distortion with too high a volume level. Please turn down the volume a bit, until distortion stops.**
- [25] The **POWER** switch turns your VIRTUBE on and off. It should always be in the OFF position when connecting the unit to the mains.

VIRTUBE VT100FXH/VT100FX/VT250FX/VT50FX

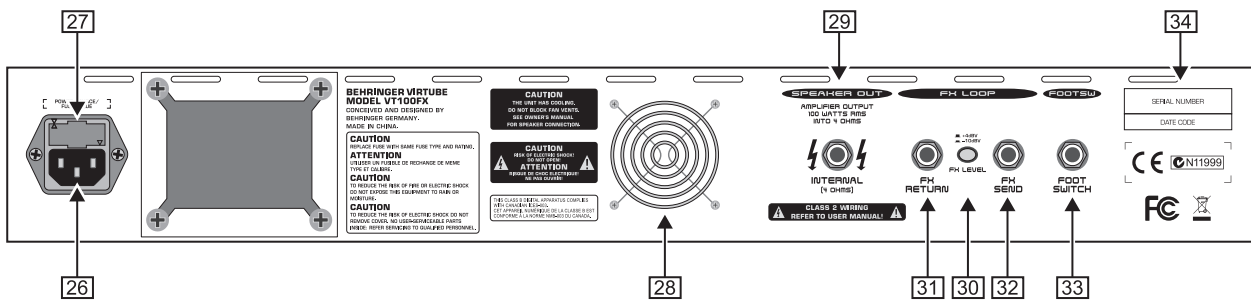

Fig. 2.2: VIRTUBE control elements (rear panel)

Please note: Merely switching the unit off does not mean that it is fully disconnected from the mains. To disconnect the unit from the mains, pull out the mains connector. Before installation, please make sure that the mains connector has not been damaged. If you do not use the unit for an extended period of time, please disconnect it at the mains.

2.2 Rear panel

- 26** The VIRTUBE is connected to the mains using a standard IEC receptacle. A suitable power cord is included with the unit.
- 27** **FUSE HOLDER/VOLTAGE SELECTOR.** Before connecting the unit to the mains, ensure that the voltage setting matches your local voltage. Blown fuses must be replaced with a fuse of the same type and rating. On some units, the fuse holder can be switched to one of two positions, i.e. 230 V and 120 V. Please note: when operating the unit outside Europe at 120 V, a higher fuse rating is required (see Chapter 4, "Installation").
- 28** This is where the fan of the unit is located.
- 29** The **SPEAKER OUT** connectors (only one on the VT100FX and VT50FX) can be used to connect external speakers with a minimum impedance of 4 Ω. The outputs of the VT250FX deliver 50 Watts of power per channel (L/R). Always use speakers with a minimum impedance of 8 Ω to ensure maximum power output. Using the **SPEAKER OUT** connectors will mute the built-in loudspeakers.

2.2.1 FX LOOP

- 30** The **FX LEVEL** button allows you to adapt the **FX LOOP** to the operating level of an external effects device (+4 dBu/-10 dBV).
- 31** The VIRTUBE provides a serial insert path for inserting external effects (e.g. reverb processor). To do so, connect the **FX SEND** jack to the input of the effects device.
- The FX SEND can also be used as a parallel output with no effects, for example, to record a "dry" guitar signal. As long as the RETURN jack is not in use, there will be no break in the internal signal path.**
- 32** Connect the **FX RETURN** jack to the output of the external effects device. The VT250FX has two jacks (L/R) because it is a stereo amplifier.
- 33** Use the **FOOTSWITCH** jack to connect the 1/4" TRS plug of the footswitch supplied with the unit. The footswitch performs a dual function: it switches between the two channels and turns the **DIGITAL FX** on and off.
- 34** **SERIAL NUMBER.**

3. APPLICATION EXAMPLES

The VIRTUBE features plenty of connectors for a wealth of applications. Here's a few examples of how flexible your VIRTUBE can be:

3.1 Set-up for practicing with playbacks

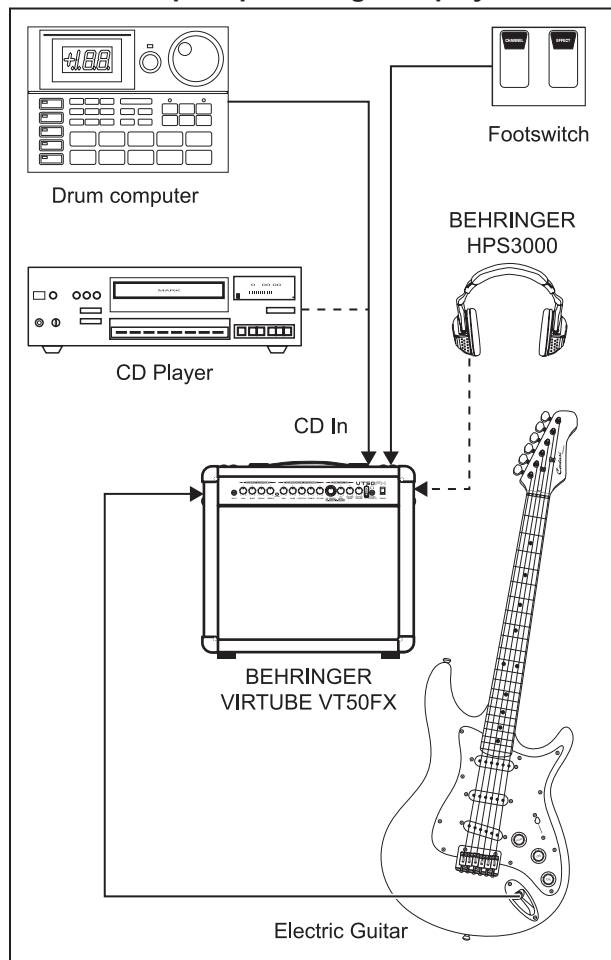

Fig. 3.1: VT50FX standard set-up

For practising in the rehearsal room or at home, please wire your VIRTUBE as shown in fig. 3.1. Connect a CD player or drum computer to the **CD IN** input. If you want to practice with headphones, connect your headphones to the **PHONES** jack. The built-in loudspeaker will be muted automatically. Connect the dual footswitch supplied with the unit to the **FOOTSWITCH** jack on the VIRTUBE. The **CHANNEL** footswitch switches between the channels. The **EFFECT** button switches the effect on and off.

3.2 Recording set-up with effects device

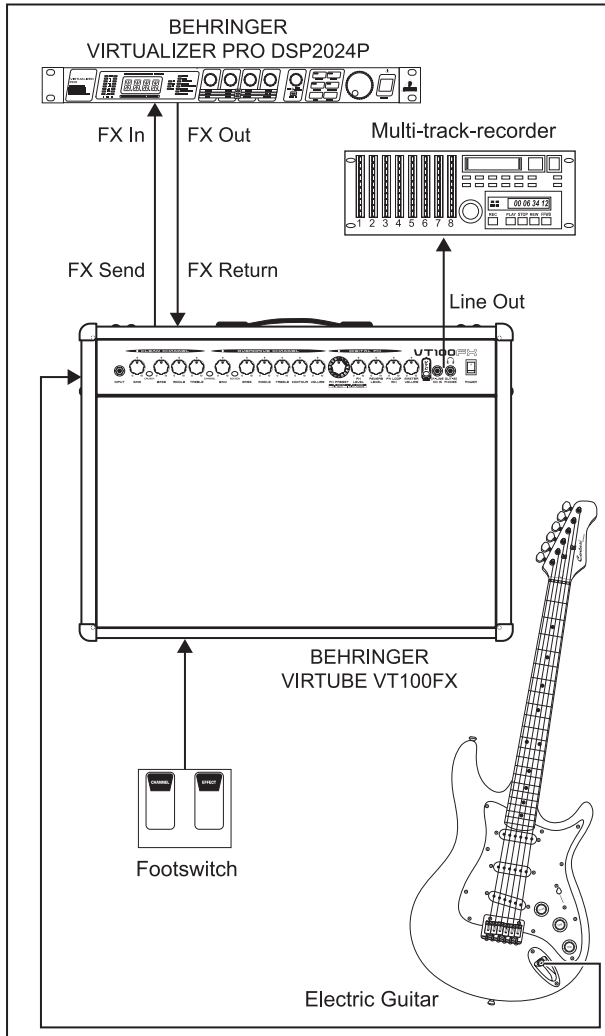

Fig. 3.2: Recording set-up with the VT100FX

If you want to use your VIRTUBE in a home-recording or studio environment, please wire it as shown in fig. 3.2. Of course, you can still use a CD player or drum computer in this set-up. This is not shown here to provide for a better overview. Connect the input of the effects device to the FX SEND and the effects output to the FX RETURN.

If you want to record your guitar signal with effects, connect the PHONES output to your mixing console, audio sequencer or multi-track recorder.

To record a "dry" guitar signal with no effect, it is best to use the FX SEND connector. You can use both outputs at the same time, for example, to record signals via the FX SEND output (no effect), while monitoring them via the PHONES output (with effect).

Instead of an external 19" effects processor, you can also use a wah-wah pedal or other stomp box. However, please note that the FX LOOP is post-preamp, i.e. after the distortion stages.

3.3 Live set-up with external speaker box

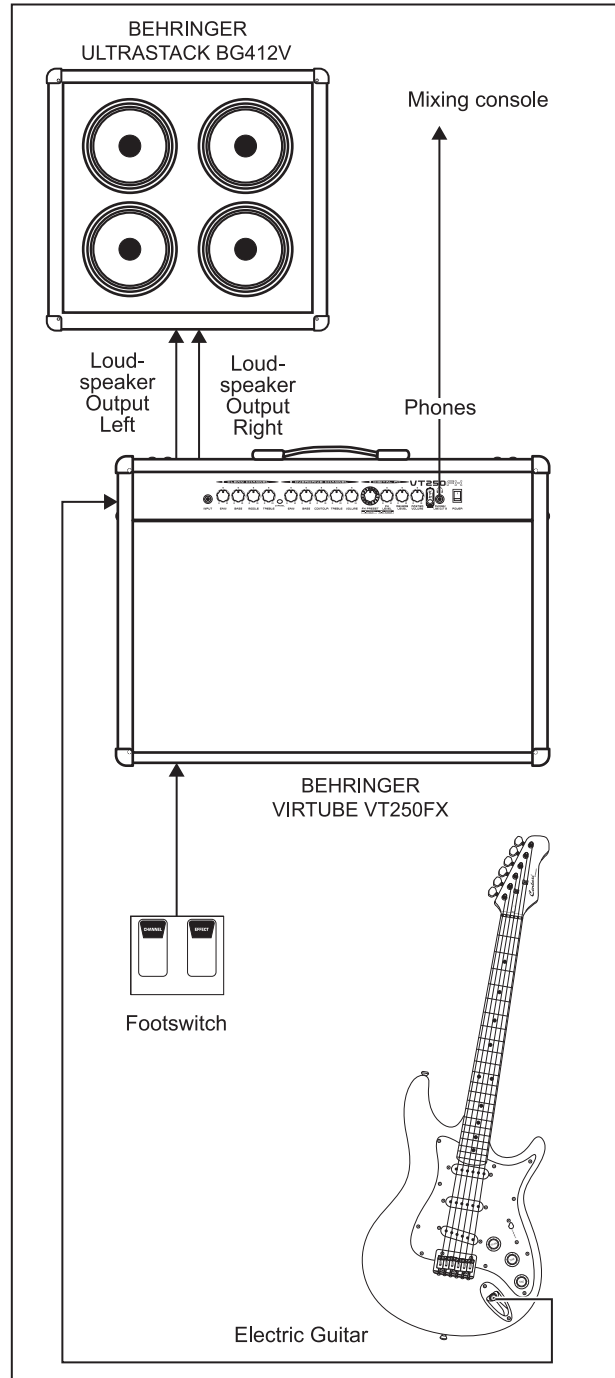

Fig. 3.3: Set-up comprising VT250FX and one speaker box

Fig. 3.3 shows how the LINE OUT/PHONES signal is routed to a mixing console. You can connect external guitar speaker boxes to the SPEAKER OUT outputs of the VIRTUBE (VT100FX and VT50FX have only one output) to achieve more power and higher volume levels on stage. When the VT250FX is used, we recommend connecting two separate speaker cabinets for stereo applications or one stereo cabinet (e.g. BEHRINGER ULTRASTACK BG412V).

en

VIRTUBE VT100FXH/VT100FX/VT250FX/VT50FX

3.4 Wiring the VT100FXH

The VT100FXH has two SPEAKER OUT outputs for connection of one or two external speaker cabinets. To achieve maximum power output on the VT100FXH, both speaker outputs should be connected to speaker cabinets with a minimum impedance of 4 Ω. Connecting headphones to the PHONES jack will automatically mute the speaker outputs.

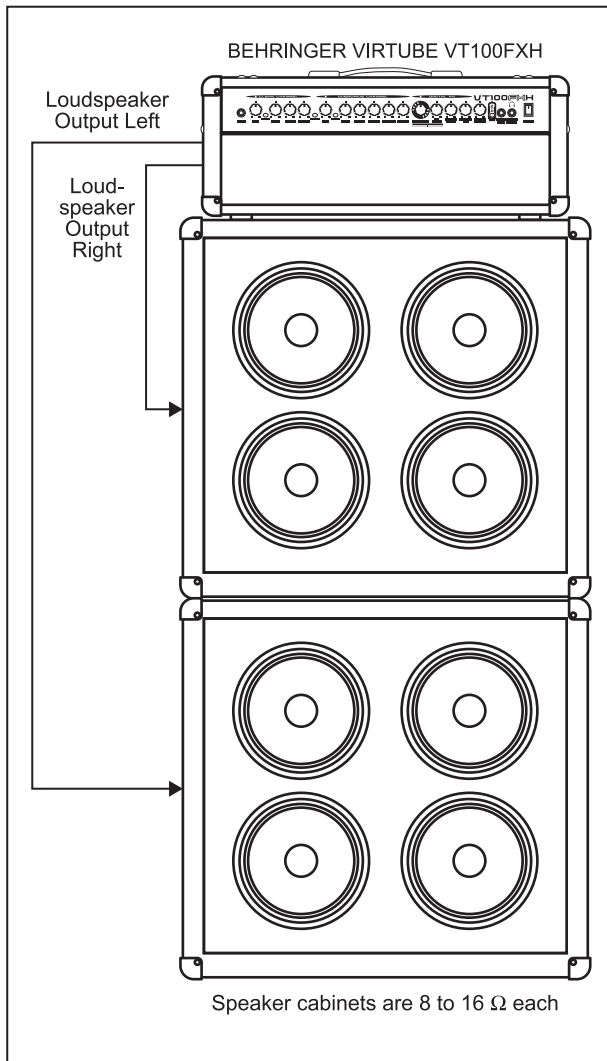

Fig. 3.4: VT100FXH with two speaker boxes

4. Installation

Except for the headphones output and the CD IN input (1/4" TRS connectors), all audio inputs and outputs on the BEHRINGER VIRTUBE are on 1/4" TS connectors. Please see Chapter 5, "Specifications" for more information.

Please ensure that the unit is installed and operated only by people qualified to do so. During installation and operation the user must have sufficient electrical contact to earth. Electrostatic discharge may affect the operation of the unit.

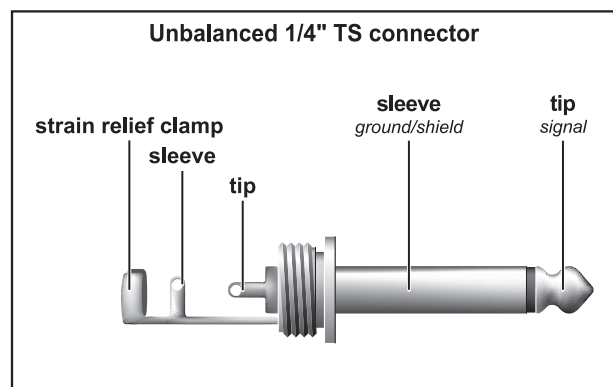

Fig. 4.1: 1/4" TS connector

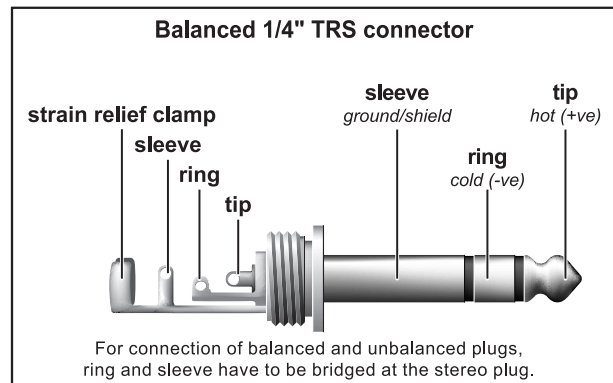

Fig. 4.2: 1/4" TRS connector

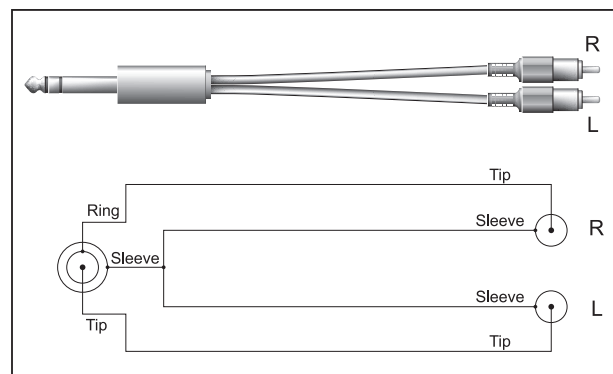

Fig. 4.3: Stereo adapter cable

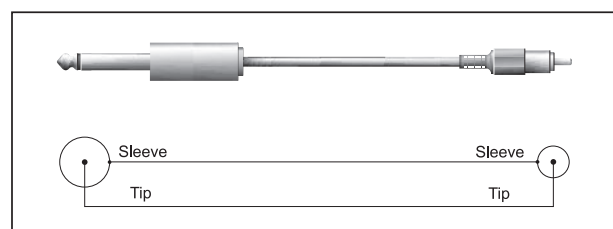

Fig. 4.4: Mono adapter cable

VIRTUBE VT100FXH/VT100FX/VT250FX/VT50FX

5. Specifications

	VT100FXH	VT100FX	VT250FX	VT50FX
AUDIO INPUTS				
INPUT	1/4" TS, RF filtered			
Input impedance	approx. 1 M Ω , unbalanced			
FX RETURN	1/4" TS		2 x 1/4" TS	1/4" TS
Input impedance	approx. 33 k Ω , unbalanced			
CD IN	1/4" TRS			
Input impedance	approx. 5.6 k Ω , unbalanced			
AUDIO OUTPUTS				
FX SEND	1/4" TS			
Output impedance	approx. 8.2, k Ω unbalanced		approx. 5.6, k Ω unbalanced	
LINE OUT/PHONES	1/4" TRS, unbalanced			
Output level	max. +16 dBV/100 Ω			
LOUDSPEAKER OUTPUTS				
Type	2 x 1/4"	1/4"	2 x 1/4"	1/4"
Min. load impedance	4 Ω		2 x 8 Ω	8 Ω
AMPLIFIER				
Peak power	100 Watts / 4 Ω		2 x 50 Watts / 8 Ω	60 Watts / 8 Ω
DIGITAL SIGNAL PROCESSING				
Converter	24-bit, sigma-delta			
Sample rate	40 kHz			
LOUDSPEAKER				
Size	-	12"	2 x 12"	12"
Model	-	BUGERA Vintage Guitar Series		
	-	12G70J4	2 x 12G50J8	12G50J8
Impedance	-	4 Ω	2 x 8 Ω	8 Ω
Continuous power (IEC268-5)	-	70 Watts	2 x 50 Watts	50 Watts
Peak power	-	280 Watts	2 x 200 Watts	200 Watts
POWER SUPPLY				
Power consumption	max. 180 Watts	max. 180 Watts	max. 180 Watts	max. 90 Watts
Fuse 100 V~, 50/60 Hz	T 3.15 A H 250 V	T 3.15 A H 250 V	T 3.15 A H 250 V	T 1.6 A H 250 V
120 V~, 50/60 Hz	T 2.5 A H 250 V	T 2.5 A H 250 V	T 2.5 A H 250 V	T 1.25 A H 250 V
220 - 230 V~, 50/60 Hz	T 1.25 A H 250 V	T 1.25 A H 250 V	T 1.25 A H 250 V	T 630 mA H 250 V
Mains connection	Standard IEC receptacle			
DIMENSIONS/WEIGHT				
Dimensions (H x W x D)	245 x 580 x 270 mm	550 x 580 x 275 mm	520 x 670 x 275 mm	520 x 515 x 275 mm
	9.7 x 22.8 x 10.6"	21.6 x 22.8 x 10.9"	20.5 x 26.3 x 10.8"	20.5 x 20.3 x 10.8"
Weight	27.3 lbs (12.4kg)	44 lbs (20 kg)	48.4 lbs (22 kg)	35.6 lbs (16.2 kg)

BEHRINGER is constantly striving to maintain the highest professional standards. As a result of these efforts, modifications may be made from time to time to existing products without prior notice. Specifications and appearance may differ from those listed or illustrated.

6. Warranty

§ 1 Other warranty rights and national law

1. This warranty does not exclude or limit the buyer's statutory rights provided by national law, in particular, any such rights against the seller that arise from a legally effective purchase contract.
2. The warranty regulations mentioned herein are applicable unless they constitute an infringement of national warranty law.

§ 2 Online registration

Please do remember to register your new BEHRINGER equipment right after your purchase by visiting www.behringer.com (alternatively www.behringer.de) and kindly read the terms and conditions of our warranty carefully.

Registering your purchase and equipment with us helps us process your repair claims quicker and more efficiently.

Thank you for your cooperation!

§ 3 Warranty

1. BEHRINGER (BEHRINGER International GmbH including all BEHRINGER subsidiaries, except BEHRINGER Japan) warrants the mechanical and electronic components of this product to be free of defects in material and workmanship for a period of one (1) year* from the original date of purchase, in accordance with the warranty regulations described below. If the product shows any defects within the specified warranty period that are not excluded from this warranty as described under § 5, BEHRINGER shall, at its discretion, either replace or repair the product using suitable new or reconditioned parts. In the case that other parts are used which constitute an improvement, BEHRINGER may, at its discretion, charge the customer for the additional cost of these parts.
2. If the warranty claim proves to be justified, the product will be returned to the user freight prepaid.
3. Warranty claims other than those indicated above are expressly excluded.

§ 4 Return authorization number

1. To obtain warranty service, the buyer (or his authorized dealer) must call BEHRINGER during normal business hours BEFORE returning the product. All inquiries must be accompanied by a description of the problem. BEHRINGER will then issue a return authorization number.
2. Subsequently, the product must be returned in its original shipping carton, together with the return authorization number to the address indicated by BEHRINGER.
3. Shipments without freight prepaid will not be accepted.

§ 5 Warranty regulations

1. Warranty services will be furnished only if the product is accompanied by a copy of the original retail dealer's invoice. Any product deemed eligible for repair or replacement under the terms of this warranty will be repaired or replaced.
2. If the product needs to be modified or adapted in order to comply with applicable technical or safety standards on a national or local level, in any country which is not the country for which the product was originally developed and manufactured, this modification/adaptation shall not be considered a defect in materials or workmanship. The warranty does not cover any such modification/adaptation, irrespective of whether it was carried out properly or not. Under the terms of this warranty, BEHRINGER shall not be held responsible for any cost resulting from such a modification/adaptation.
3. Free inspections and maintenance/repair work are expressly excluded from this warranty, in particular, if caused by improper handling of the product by the user. This also applies to defects caused by normal wear and tear, in particular, of faders, crossfaders, potentiometers, keys/buttons, tubes, guitar strings, illuminants and similar parts.
4. Damage/defects caused by the following conditions are not covered by this warranty:

- ▲ improper handling, neglect or failure to operate the unit in compliance with the instructions given in BEHRINGER user or service manuals.
 - ▲ connection or operation of the unit in any way that does not comply with the technical or safety regulations applicable in the country where the product is used.
 - ▲ damage/defects caused by force majeure or any other condition that is beyond the control of BEHRINGER.
5. Any repair or opening of the unit carried out by unauthorized personnel (user included) will void the warranty.
 6. If an inspection of the product by BEHRINGER shows that the defect in question is not covered by the warranty, the inspection costs are payable by the customer.
 7. Products which do not meet the terms of this warranty will be repaired exclusively at the buyer's expense. BEHRINGER will inform the buyer of any such circumstance. If the buyer fails to submit a written repair order within 6 weeks after notification, BEHRINGER will return the unit C.O.D. with a separate invoice for freight and packing. Such costs will also be invoiced separately when the buyer has sent in a written repair order.

§ 6 Warranty transferability

This warranty is extended exclusively to the original buyer (customer of retail dealer) and is not transferable to anyone who may subsequently purchase this product. No other person (retail dealer, etc.) shall be entitled to give any warranty promise on behalf of BEHRINGER.

§ 7 Claim for damages

Failure of BEHRINGER to provide proper warranty service shall not entitle the buyer to claim (consequential) damages. In no event shall the liability of BEHRINGER exceed the invoiced value of the product.

* Customers in the European Union please contact BEHRINGER Germany Support for further details.

Technical specifications and appearance are subject to change without notice. The information contained herein is correct at the time of printing. BEHRINGER accepts no liability for any loss which may be suffered by any person who relies either wholly or in part upon any description, photograph or statement contained herein. Colors and specifications may vary slightly from product. Products are sold through our authorized dealers only. Distributors and dealers are not agents of BEHRINGER and have absolutely no authority to bind BEHRINGER by any express or implied undertaking or representation. No part of this manual may be reproduced or transmitted in any form or by any means, electronic or mechanical, including photocopying and recording of any kind, for any purpose, without the express written permission of BEHRINGER International GmbH.

ALL RIGHTS RESERVED.
(c) 2008 BEHRINGER International GmbH.
BEHRINGER International GmbH, Hanns-Martin-Schleyer-Str. 36-38, 47877 Willich-Muenchheide II, Germany.
Tel. +49 2154 9206 0, Fax +49 2154 9206 4903 515