

G1on/G1Xon

Guitar Multi-Effects Processor

OPERATION MANUAL

Thank you very much for purchasing the ZOOM **G1on/G1Xon**.

Please read this manual carefully to learn about all the functions of the **G1on/G1Xon** so that you will be able to use it fully for a long time.

Keep this manual in a convenient place for reference when necessary.



Contents

Usage and Safety Precautions.....	2	Saving and Swapping Patches	15
Introduction	3	Changing Various Settings	16
Part Names.....	4	Using the Tuner	20
Turning the Power ON	6	Using Rhythms	22
Display Information.....	7	Using the Looper	24
Terms Used in This Manual.....	7	Using the Expression Pedal (G1Xon only)	26
Using Patches.....	8	Updating the Firmware.....	28
Adjusting Effects.....	10	Troubleshooting	30
Adjusting the Master Level and Tempo.....	14	Specifications	31



Usage and Safety Precautions

SAFETY PRECAUTIONS

In this manual, symbols are used to highlight warnings and cautions that you must read to prevent accidents. The meanings of these symbols are as follows:

	Something that could cause serious injury or death.
	Something that could cause injury or damage to the equipment.

Other symbols

	Required (mandatory) actions.
	Prohibited actions.

Warning

Operation using an AC adapter

- 1 Use only a ZOOM AD-16 AC adapter with this unit.
- ⊘ Do not use do anything that could exceed the ratings of outlets and other electrical wiring equipment. Before using the equipment in a foreign country or other region where the electrical voltage differs from that indicated on the AC adapter, always consult with a shop that carries ZOOM products beforehand and use the appropriate AC adapter.

Operation using batteries

- 1 Use 4 conventional 1.5-volt AA batteries (alkaline or nickel-metal hydride).
- 1 Read battery warning labels carefully.
- 1 Always close the battery compartment cover when using the unit.

Alterations

- ⊘ Never open the case or attempt to modify the product.

Caution

Product handling

- 1 Do not drop, bump or apply excessive force to the unit.
- 1 Be careful not to allow foreign objects or liquids to enter the unit.

Operating environment

- ⊘ Do not use in extremely high or low temperatures.
- ⊘ Do not use near heaters, stoves and other heat sources.
- ⊘ Do not use in very high humidity or near splashing water.
- ⊘ Do not use in places with excessive vibrations.
- ⊘ Do not use in places with excessive dust or sand.

AC adapter handling

- 1 When disconnecting the AC adapter from an outlet, always pull the body of the adapter itself.
- 1 During lightning storms or when not using the unit for a long time, disconnect the power plug from the AC outlet.

Battery handling

- 1 Install the batteries with the correct +/- orientation.
- 1 Use a specified battery type. Do not mix new and old batteries or different brands or types at the same time. When not using the unit for an extended period of time, remove the batteries from the unit.
- 1 If a battery leak should occur, wipe the battery compartment and the battery terminals carefully to remove all battery residue.

Connecting cables with input and output jacks

- 1 Always turn the power OFF for all equipment before connecting any cables.
- 1 Always disconnect all connection cables and the AC adapter before moving the unit.

Volume

- ⊘ Do not use the product at a loud volume for a long time.

Usage Precautions

Interference with other electrical equipment

In consideration of safety, the **G1on/G1Xon** has been designed to minimize the emission of electromagnetic radiation from the device and to minimize external electromagnetic interference. However, equipment that is very susceptible to interference or that emits powerful electromagnetic waves could result in interference if placed nearby. If this occurs, place the **G1on/G1Xon** and the other device farther apart. With any type of electronic device that uses digital control, including the **G1on/G1Xon**, electromagnetic interference could cause malfunction, corrupt or destroy data and result in other unexpected trouble. Always use caution.

Cleaning

Use a soft cloth to clean the panels of the unit if they become dirty. If necessary, use a damp cloth that has been wrung out well. Never use abrasive cleansers, wax or solvents, including alcohol, benzene and paint thinner.

Malfunction

If the unit becomes broken or malfunctions, immediately disconnect the AC adapter, turn the power OFF and disconnect other cables. Contact the store where you bought the unit or ZOOM service with the following information: product model, serial number and specific symptoms of failure or malfunction, along with your name, address and telephone number.

Copyrights

• All trademarks, product names and company names mentioned in this documentation are the property of their respective owners.

Note: All trademarks and registered trademarks mentioned in this manual are for identification purposes only and are not intended to infringe on the copyrights of their respective owners.

Introduction

Five simultaneous effects

You can select and arrange the order of up to five effects as you like and use them simultaneously. Use the cursor keys and view the effects being used on the LCD anytime.

Variety of rhythm patterns

Realistic sounds are provided with updated rhythm patterns and tones.

Looper

The looper can be synchronized with rhythms and record phrases of up to 30 seconds.

Realistic amplifier modeling

With realistic amplifier modeling sounds from our **G3**, we have faithfully re-created the rich harmonics and compression feel of tube amps.

Long battery operation time

20 hours of continuous operation is possible using alkaline batteries (when the LCD backlight is off).

* A printed list of effect parameters is not included with the **G1on/G1Xon**.
Please download a copy from the ZOOM website. → <http://www.zoom.co.jp/>

Part Names

■ Top Panel

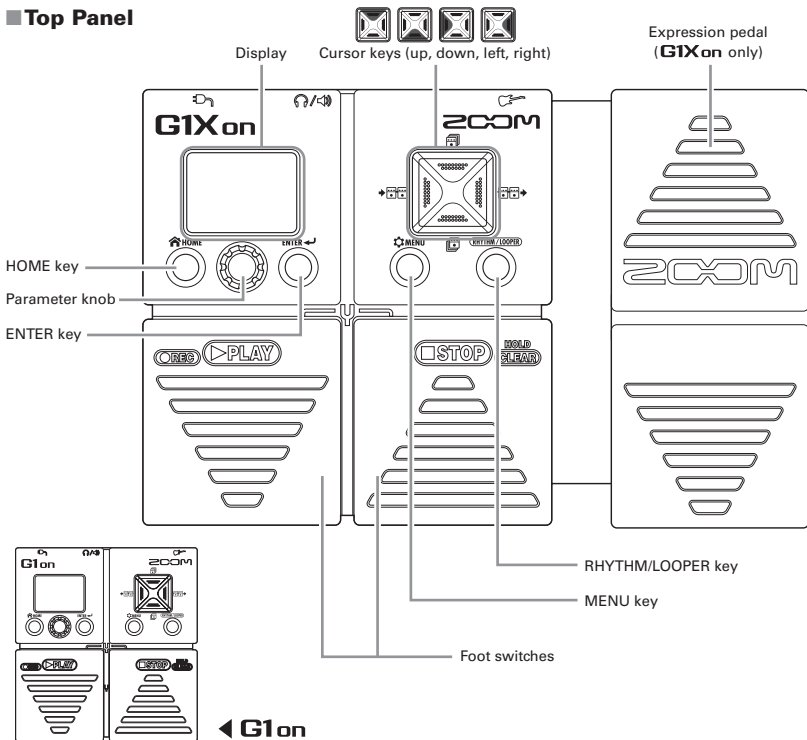

■ Rear Panel

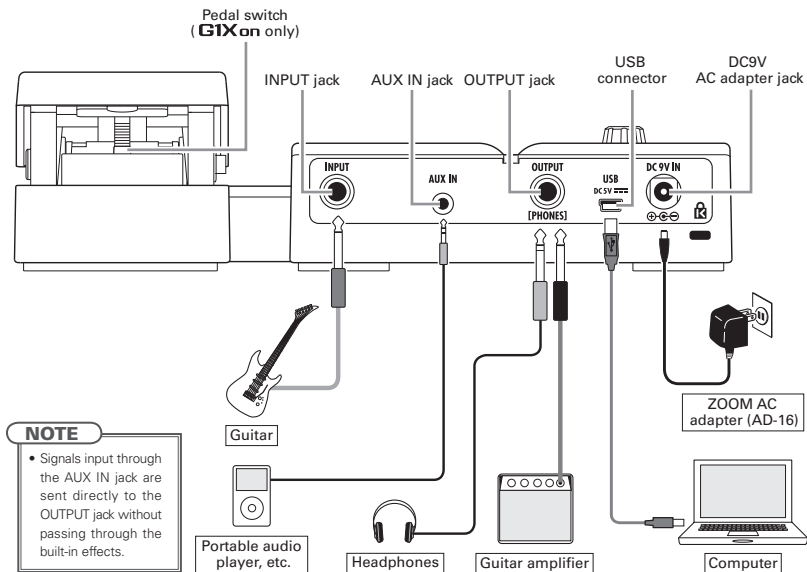

Turning the Power ON

Lower the amplifier's volume all the way.

■ When using batteries

Insert batteries into the battery compartment.

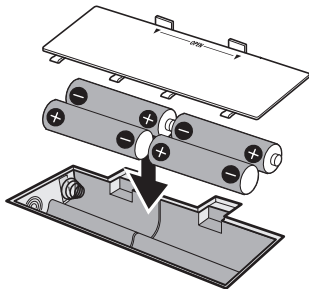

Plug a guitar cable into the INPUT jack.
(Doing so turns the unit on.)

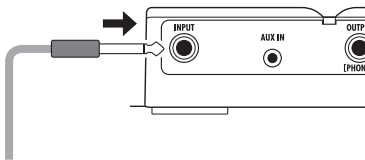

■ When using an adapter

Connect an AD-16 adapter.

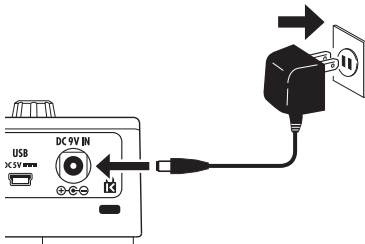

Turn the amplifier's power on and raise its volume.

NOTE

- USB bus power operation is possible.

eco mode

If the eco mode setting is ON and it is left unused for 10 hours, it turns off automatically. (See page 16.)

Display Information

HOME Screen

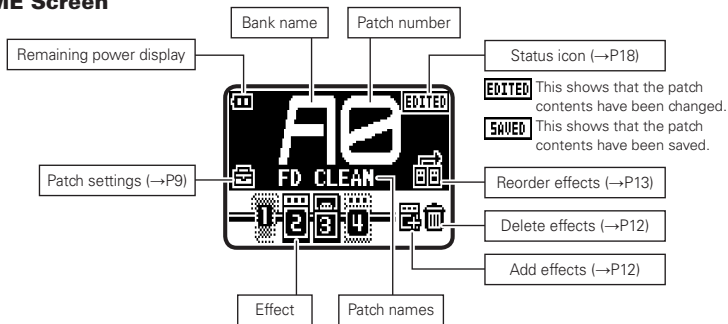

HINT

- Press  to return to the HOME screen from any other screen.
- Effects that are OFF appear gray.

Terms Used in This Manual

Patch

The ON/OFF status and the parameter settings of each effect are stored as "patches". Use patches to recall and save effects. The **G1on/G1Xon** can store 100 patches.

Bank

A set of 10 patches is called a "bank".

The **G1on/G1Xon** has 10 banks labeled A–J.



Using Patches

To change the patch

Use  and .



HINT

- For details about using the preselect function to change directly to patches that are not next in order, see page 19.
- Press and hold  or  to change patches continuously.

To change the bank

Use  and .



To change settings for individual patches

Turn  on the HOME screen.
Select PATCH SETTINGS.

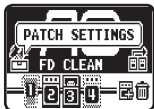

Press .
The PATCH SETTINGS screen appears.



Press .
The patch editing screen appears.

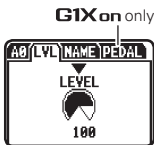

Turn .
Open the page you want.

To adjust the patch level (LVL)

Turn .
Select LEVEL.



Press .

Turn .
Set between 0 and 120.



To change the patch name (NAME)

Turn .
Move the cursor.



Press .
Confirm the character to change.

Turn .
Change the character.



HINT

- You can use  and  to change the type of character/symbol.

Adjusting Effects

To select an effect

Turn  on the HOME screen.

Select the effect.



Virtual knob



Graphic for selected effect

HINT

- The virtual knobs are shown with the current parameter values.

To turn an effect ON or OFF

Press  or .



Effect ON



Effect OFF

To select an effect type

Use  and .

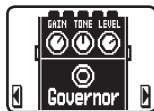



• Effect processing capacity

The **G1on/G1Xon** allows you to combine five effects as you like. However, if you combine effect types that require great amounts of processing power (amp models, for example), the available processing capacity might not be enough. If this occurs, "PROCESSING LIMIT" will appear, and the effect will be bypassed. You can avoid this by changing some of the effect types.



To select from a category

Press and hold  or .
The categories appear.



Turn .
Select the category.







Press .

NOTE

- The **G1X on** includes a PEDAL effects category.

To scroll through the effects shown

When using multiple effects, scroll to switch the effect shown.

Use    and  .



To adjust parameters

Press .

The editing screen appears.

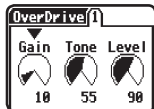

Turn .

Select the parameter to adjust.

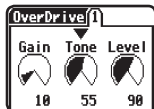

Press .

Confirm the parameter to adjust.

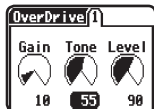

Turn .

Adjust the parameter value.

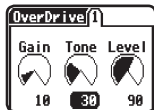

HINT

- When shipped from the factory, the auto save function is active. As soon as a parameter is adjusted this change is automatically saved. (See page 18.)

Adjusting Effects

To add an effect

Turn  on the HOME screen.

Select ADD EFFECT.



Press .

Open the category selection screen.



Turn .

Select the category.



Press .

Open the added effect placement screen.



Turn .

Select where to add the effect.



Press .

Add the effect.



Turn  to end.

Select EXIT.



Press .

HINT

- On the effect screen, you can also press and hold  or  to add an effect.

To remove an effect

Turn  on the HOME screen.

Select DELETE EFFECT.



Press .

Open the effect deletion screen.





Select the effect to delete.



Open the confirmation screen.



Delete the effect.



Select EXIT.



To change the order of effects

Turn  on the HOME screen.

Select EFFECT CHAIN.



Open the EFFECT CHAIN screen.

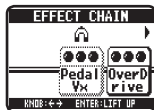

Select the effect to move.

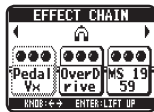

Confirm the effect to move.

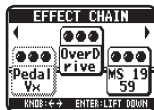

Select the new position for the effect.

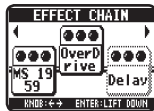

Confirm the new position.

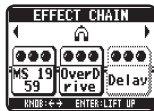

Adjusting the Master Level and Tempo

To adjust the master level



Press on the HOME screen.
Open the MENU screen.

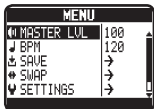

Select MASTER LVL.

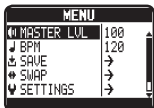

Press .

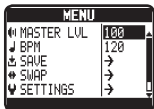

Set between 0 and 120.

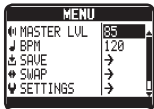

Press to end.

To adjust the master tempo (BPM)



Press on the HOME screen.
Open the MENU screen.

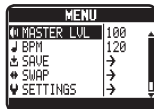

Select BPM.

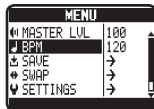

Press .

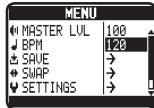

Set between 40 and 250.

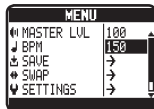

NOTE

- This tempo setting is shared by all effects, rhythms and the looper.



Press to end.

Saving and Swapping Patches

To save the current patch



Press on the HOME screen.
Open the MENU screen.

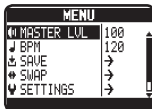

Turn .
Select SAVE.

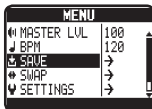

Press .
Open the patch SAVE screen.



Turn .
Select where to save the patch.



Press .
Open the confirmation screen.



Turn .
Select "YES" to execute.
Select "NO" to cancel.



Press .

To swap the current patch



Press on the HOME screen.
Open the MENU screen.

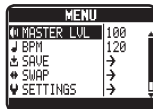

Turn .
Select SWAP.

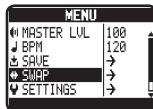

Press .
Open the patch SWAP screen.



Turn .
Select the other patch to swap.



Press .
Open the confirmation screen.



Turn .
Select "YES" to execute.
Select "NO" to cancel.



Press .

NOTE

- Patches cannot be swapped if the current patch has not been saved.

Changing Various Settings



Press on the HOME screen.
Open the MENU screen.

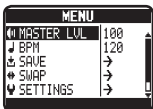

Turn .
Select SETTINGS.

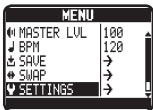

Press .
Open the SETTINGS screen.

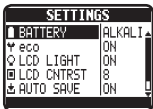

To select the battery type

Turn on the SETTINGS screen.
Select BATTERY.

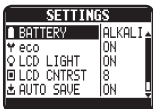

Press .

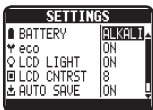

Turn .

Select ALKALI (alkaline) or Ni-MH (nickel-metal hydride).

To set the eco mode

Turn on the SETTINGS screen.



Select eco.

Press .

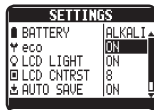

Turn .

Select ON or OFF.

HINT

- ON: eco mode is active. If left unused for 10 hours, the power turns off automatically.
- OFF: eco mode is not active.

To adjust the backlight time

Turn  on the
SETTINGS screen.
Select LCD LIGHT.

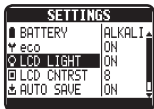

Press  .

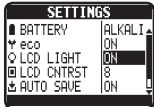

Turn  .

Select OFF, ON, 15sec or 30sec.

To adjust the display contrast

Turn  on the
SETTINGS screen.
Select LCD CNTRST.

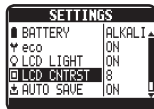

Press  .

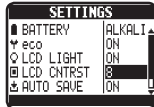

Turn  .

Set between 1 and 13.

Changing Various Settings

To set the auto save function

Turn  on the SETTINGS screen.
Select AUTO SAVE.

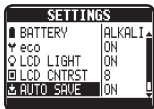

Press  .

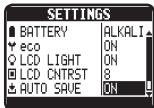

Turn .
Select ON or OFF.

When AUTO SAVE is ON

Patch changes will be saved automatically.

This shows that the patch has been changed.



This shows that the patch has been saved.



When AUTO SAVE is OFF

Patch changes will not be saved until they are saved manually.

If a patch has been changed, a confirmation screen will appear when you try to open another patch.



Turn .
Select "YES" to save.
Select "NO" to not save.



Press  .

NOTE

- If you select "NO", the patch setting changes will not be saved and the other patch will open.

Turn .
Select where to save the patch.

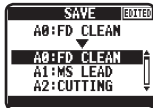

Press  .

Open the confirmation screen.



Turn  .

Select "YES" to save.
Select "NO" to cancel.

Press  .

The patch changes are saved.

HINT

- You can also save from the MENU screen.
- See "To save the current patch". (See page 15.)

NOTE

- If a patch has not been saved, patches cannot be swapped. (See page 15.)

To use the preselect function

Turn  on the SETTINGS screen.
Select PRESELECT.

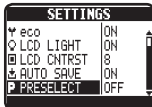

Press  .

Turn  .

Select ON or OFF.



HINT

- ON: The preselect function is active. You can select the next patch before changing to it.
- OFF: The preselect function is inactive.

■ When PRESELECT is ON

On the HOME screen,
use  and  .

Select the next patch.





Press  and  at the same time.

Change to the selected patch.



Using the Tuner

To activate the tuner

On the HOME screen or an effect screen, press  and  at the same time.

Open the tuner screen.

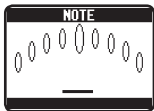

To tune the guitar

You can play each open string and tune it.

■ CHROMATIC TUNER

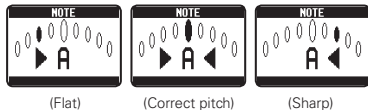

(Flat)

(Correct pitch)

(Sharp)

The name of the nearest note and the pitch accuracy are shown.

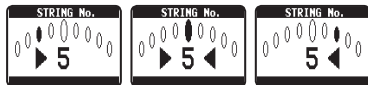

■ OTHER TUNERS



(Flat)

(Correct pitch)

(Sharp)

Press  or  to end.

To change tuner settings

On the tuner screen, press  .
Open the TUNER settings screen.

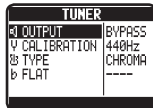

Turn  .
Select the item to set.

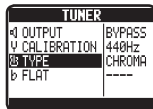

Press  .
Confirm the item to set.

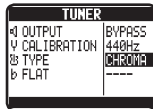

Turn  .
Change the setting.

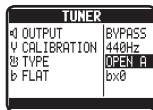

Press  to end.

● Setting items

OUTPUT

Select BYPASS or MUTE.

Standard pitch (CALIBRATION)

The standard pitch for middle A can be set from 435-445 Hz.

Tuner types (TYPE)

Select chromatic (CHROMA) or another tuner type. The other tuner types are shown in the table below.

Drop tuning (FLAT)

Set to $b \times 0$, $b \times 1$, $b \times 2$ or $b \times 3$.

NOTE

- Drop tuning is not possible when the TYPE is set to CHROMA.

Tuner types

Display	Meaning	String number/Note name						
		7	6	5	4	3	2	1
GUITAR	Standard tuning for guitars, including 7-string guitars	B	E	A	D	G	B	E
OPEN A	In open A tuning, the open strings make an A chord	-	E	A	E	A	C#	E
OPEN D	In open D tuning, the open strings make a D chord	-	D	A	D	F#	A	D
OPEN E	In open E tuning, the open strings make an E chord	-	E	B	E	G#	B	E
OPEN G	In open G tuning, the open strings make a G chord	-	D	G	D	G	B	D
DADGAD	This alternate tuning is often used for tapping, etc.	-	D	A	D	G	A	D

Using Rhythms

To activate a rhythm

On the HOME screen or an effect screen, press







Open the RHYTHM screen.



HINT

- On the RHYTHM screen, press  to switch to the LOOPER screen.

To set the pattern, tempo and volume

On the RHYTHM screen, turn .

Select the item to set.

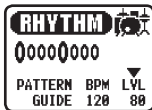

Press .

Confirm the item to set.



Turn .

Change the setting.



Setting items

PATTERN

Select the rhythm pattern. For more about rhythm patterns. (See page 23.)

Tempo (BPM)

The setting range is 40-250.

NOTE

- This tempo setting is used by every effect, rhythms and the looper.

Volume (LVL)

The setting range is 0-100.

To start rhythm playback

On the RHYTHM screen, press .

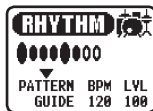

To stop the rhythm

On the RHYTHM screen, press



HINT

- On the RHYTHM screen, you can press  to return to the HOME screen while the rhythm continues playing.

Rhythm patterns

No.	PatternName	TimSig
1	GUIDE	4/4
2	8Beats1	4/4
3	8Beats2	4/4
4	8Beats3	4/4
5	16Beats1	4/4
6	16Beats2	4/4
7	16Beats3	4/4
8	Rock1	4/4
9	Rock2	4/4
10	Rock3	4/4
11	ROCKABLY	4/4
12	R'n'R	4/4
13	HardRock	4/4
14	HeavyMtl	4/4
15	Mt/Core	4/4
16	Punk	4/4
17	FastPunk	4/4
18	Emo	4/4
19	TomTomBt	4/4
20	Funk1	4/4
21	Funk2	4/4
22	FunkRock	4/4
23	JazzFunk	4/4

No.	PatternName	TimSig
24	R&B1	4/4
25	R&B2	4/4
26	70s Soul	4/4
27	90s Soul	4/4
28	Motown	4/4
29	HipHop	4/4
30	Disco	4/4
31	Pop	4/4
32	PopRock	4/4
33	IndiePop	4/4
34	EuroPop	4/4
35	NewWave	4/4
36	OneDrop	4/4
37	Steppers	4/4
38	Rockers	4/4
39	Ska	4/4
40	2nd Line	4/4
41	Country	4/4
42	Shuffle1	4/4
43	Shuffle2	4/4
44	Blues1	4/4
45	Blues2	4/4
46	Jazz1	4/4

No.	PatternName	TimSig
47	Jazz2	4/4
48	Fusion	4/4
49	Swing1	4/4
50	Swing2	4/4
51	Bossa1	4/4
52	Bossa2	4/4
53	Samba1	4/4
54	Samba2	4/4
55	Breaks1	4/4
56	Breaks2	4/4
57	Breaks3	4/4
58	12/8 Grv	12/8
59	Waltz	3/4
60	JzWaltz1	3/4
61	JzWaltz2	3/4
62	CtWaltz1	3/4
63	CtWaltz2	3/4
64	5/4 Grv	5/4
65	Metro3	3/4
66	Metro4	4/4
67	Metro5	5/4
68	Metro	

Using the Looper

To activate the looper

On the HOME screen or an effect screen, press

RHYTHM/LOOPER



Open the LOOPER screen.



HINT

- On the LOOPER screen, press RHYTHM/LOOPER to switch to the RHYTHM screen.

To set the recording time, tempo and volume

On the LOOPER screen, turn

Select the item to set.



Press

Confirm the item to set.



Turn

Change the setting.



Setting items

Recording time (TIME)

Set to MANUAL or in a range from $J \times 1$ to $J \times 64$.

NOTE

- The looper can record up to 30 seconds.
- If the setting (number of quarter notes) would not fall in this range, it will automatically be adjusted.
- Changing the recording time will erase the currently recorded loop.

Tempo (BPM)

The setting range is 40-250.

NOTE

- Changing the tempo will erase the currently recorded loop.
- This tempo setting is used by every effect, rhythms and the looper.

Volume (LVL)

The setting range is 0-100.

To record and play back a phrase

On the LOOPER screen, press .

Start recording.

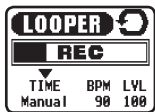

After the recording time elapses, playback will start.



■ When TIME is set to MANUAL

Loop playback start when you press  or the maximum recording time (30 seconds) is reached.

NOTE

- During rhythm playback, recording will start after a pre-count.

To overdub a recorded loop

During loop playback, press .

Press  to end.



To stop loop playback

On the LOOPER screen, press .



To erase the loop

Stop loop playback and press and hold  on the LOOPER screen.



HINT

- On the LOOPER screen, you can press  to return to the HOME screen while recording a loop or playing it back.

Using the Expression Pedal (G1X on only)

If a PEDAL category effect has been added, settings will be made automatically to allow control of expression pedal parameters.

To change the pedal settings

Turn  on the HOME screen.

Select PATCH SETTINGS.



Press .

Open the PATCH SETTINGS screen.



Press .

Open the patch editing screen.



Turn .

Open the PEDAL setting screen.

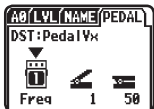

To set the controlled parameter and range

Turn  on the PEDAL setting screen.

Select the item to set.

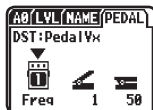

Press .

Confirm the item to set.



Turn .

Change the setting.

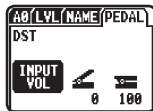

Setting items

Controlled parameter 

Minimum value (pedal up) 
This differs according to the effects type.

Maximum value (pedal down) 
This differs according to the effects type.

HINT

- NO ASSIGN: No function is assigned to the expression pedal.
- AUTO ASSIGN: When using a PEDAL category effect, a parameter will be assigned to the pedal automatically.
If multiple PEDAL category effects are used, their corresponding parameters will all be assigned to the expression pedal.
- INPUT VOL: Controls the input level.
- OUTPUT VOL: Controls the output level. (Does not affect the volume of the rhythm or looper.)
- The pedal switch can be used to turn ON/OFF effects that are assigned to the expression pedal. (The ON/OFF setting made by the pedal switch is not saved.)

To calibrate its sensitivity

While pressing  , turn the unit on. (See page 6.)



Operate the pedal as the instructions show and press  each time.

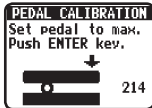

"Complete!" appears when calibration is finished.

NOTE

- If "Error!" appears, restart calibration from the beginning.

To adjust the torque

Insert the hex key into the torque adjustment screw on the side of the pedal.

Turn it clockwise to tighten the pedal, and turn it counterclockwise to loosen the pedal.

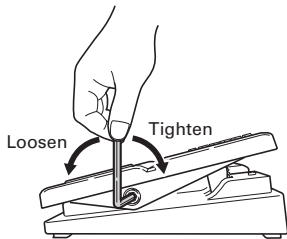

NOTE

- Be careful when loosening the screw. Loosening it too much could cause it to come off inside the unit.

Updating the Firmware

Download the latest firmware from the ZOOM website.

<http://www.zoom.co.jp/>

To view the firmware versions





Press  on the HOME screen.

Open the MENU screen.

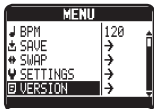

Select VERSION.



Press .

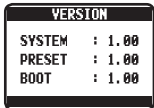

The firmware version is shown.



Press  to end.

To update the firmware

Confirm that the power is off.

While pressing both  and , connect the unit to a computer using a USB cable.



The FIRMWARE UPDATE screen appears.

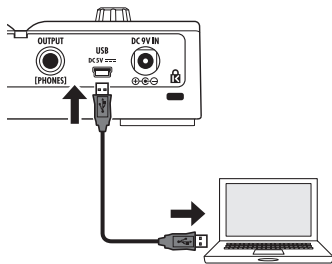

Launch the firmware update application on your computer, and execute the update.

When it finishes updating, "Complete!" appears on the display.

Disconnect the USB cable.

HINT

- Updating the firmware will not erase saved patches.

NOTE

- Do not disconnect the USB cable while the firmware is being updated.

To restore the **G1on/G1Xon** to its factory default settings

While pressing , turn the power ON.
(See page 6.)

The All INITIALIZE screen appears.



Turn .
Select "YES" to execute.
Select "NO" to cancel.

Press .

NOTE

- Be careful because this will restore all defaults to their factory settings. Be sure that you want to do this.

Troubleshooting

The unit will not turn ON

- If operating on battery power, connect a cable to the INPUT jack.

No sound or very low volume

- Check the connections (→P5).
- Adjust the levels of the effects being used (→P11).
- Adjust the master level (→P14).
- When adjusting the volume with an expression pedal, make sure that a suitable volume setting has been set with the pedal.
- Confirm that the TUNER OUTPUT is not set to "MUTE" (→P20).

There is a lot of noise

- Check shielded cables for defects.
- Use only a genuine ZOOM AC adapter (→P6).

An effect is not working

- If the effect processing capacity is exceeded, "PROCESSING LIMIT" appears on the effect graphic. In this case, the effect is bypassed (→P10).

Batteries lose their charge quickly

- Confirm that you are not using manganese batteries. Alkaline batteries should provide about 20 hours of continuous operation.
- Check the battery setting.
Set the type of battery being used to enable the remaining charge to be shown more accurately (→P16).
- Due to the characteristics of the batteries, they might be used more quickly in cold.

The expression pedal is not working well

- Check the expression pedal settings (→P26).
- Adjust the expression pedal (→P27).

Specifications

Effect types	G1on	75 types
	G1Xon	80 types
Number of simultaneous effects		5
Number of user banks/patches		10 patches x 10 banks
Sampling frequency		44.1kHz
A/D conversion		24-bit with 128x oversampling
D/A conversion		24-bit with 128x oversampling
Signal processing		32-bit floating point & 32-bit fixed point
Display		LCD
Input	INPUT	Standard monaural phone jack Rated input level: -20dBm Input impedance (Line): 470k Ω
	AUX IN	Stereo mini jack Rated input level: -10dBm Input impedance (Line): 1k Ω
Output	OUTPUT	Standard stereo phone jack Maximum output level: Line + 2dBm (with output load impedance of 10 k Ω or more) Headphones 17mW + 17mW (into 32 Ω load)
S/N (equivalent input noise)		119dB
Noise floor (residual noise)		-97dBm
Power		AC adapter DC9V (center minus plug), 500 mA (ZOOM AD-16) 20 hours of continuous operation using 4 alkaline AA batteries (with LCD backlight off)
USB		Firmware update
Dimensions	G1on	154.8mm(D) x 146.0mm(W) x 43.0mm (H)
	G1Xon	154.8mm(D) x 237.0mm(W) x 50.0mm (H)
Weight	G1on	380g (Not including batteries)
	G1Xon	640g (Not including batteries)

*0dBm = 0.775Vrms

FCC regulation warning (for U.S.A.)

This equipment has been tested and found to comply with the limits for a Class B digital device, pursuant to Part 15 of the FCC Rules. These limits are designed to provide reasonable protection against harmful interference in a residential installation. This equipment generates, uses, and can radiate radio frequency energy and, if not installed and used in accordance with the instructions, may cause harmful interference to radio communications. However, there is no guarantee that interference will not occur in a particular installation. If this equipment does cause harmful interference to radio or television reception, which can be determined by turning the equipment off and on, the user is encouraged to try to correct the interference by one or more of the following measures:

- Reorient or relocate the receiving antenna.
- Increase the separation between the equipment and receiver.
- Connect the equipment to an outlet on a circuit different from that to which the receiver is connected.
- Consult the dealer or an experienced radio/TV technician for help.

For EU Countries



Declaration of Conformity:

This product complies with the requirements of
EMC Directive 2004/108/EC and
ErP Directive 2009/125/EC and
RoHS Directive 2011/65/EU



Disposal of Old Electrical & Electronic Equipment

(Applicable in European countries with separate collection systems)

This symbol on the product or on its packaging indicates that this product shall not be treated as household waste. Instead it shall be handed over to the applicable collection point for the recycling of electrical and electronic equipment. By ensuring this product is disposed of correctly, you will help prevent potential negative consequences for the environment and human health, which could otherwise be caused by inappropriate waste handling of this product. The recycling of materials will help to conserve natural resources. For more detailed information about recycling of this product, please contact your local city office, your household waste disposal service or the shop where you purchased the product.

ZOOM®

ZOOM CORPORATION

4-4-3 Kanda-Surugadai, Chiyoda-ku, Tokyo 101-0062 Japan

<http://www.zoom.co.jp>

G1 on

Guitar Multi-Effects Processor



Manufacturer names and product names mentioned in this patch list are trademarks or registered trademarks of their respective owners and do not indicate any affiliation with ZOOM CORPORATION.
All product and artist names are intended only to illustrate sonic characteristics that were used as reference in the development of this product.

CATEGORY	BANK / PATCH	PATCH NAME	COMMENT
Demo	A	0 MUSEUM	Distortion from the DZ DRIVE effect is used to create this modern UK rock sound.
		1 Duermete	Delay, reverb and chorus combine to create a dreamy atmosphere.
		2 Blue Lead	A traditional sound like you can hear in the Memphis, Tennessee, part of the blues heartland.
		3 AUTOWAH	AutoWah effect, fun sound.
		4 Down Heavy	This modern heavy sound even works with down-tuning and also cuts noise well.
		5 ChorusPad	The StereoCho effect contributes to this majestic reverb sound.
		6 PhasrFunk	The settings of this patch add the fluctuating sound of a phaser to a sharp, clean tone.
		7 Jazzy Lead	A simple smooth lead tone perfect for light smooth jazz. T Scream and Comp are combined for perfect sustain.
		8 Acoustix	The Aco.Sim was utilized to get a nice clean authentic acoustic sound. HD Hall was added for the space.
9 Supernova	This grand sound uses the ParticleR effect.		
Clean	B	0 CLEAN	All purpose clean sound with compression and reverb.
		1 CORONA	Shimmering chorus with pushed clean tone.
		2 STRATTY	Cleaner style guitar designed for single coil pickups.
		3 Clean Arp	This incredibly clean arpeggio sound uses the Aco.Sim effect. Have fun playing celebrated arpeggios with it.
		4 Just Funk	This funky sound will make you want to play rhythmically. The Spring63 effect is the key.
		5 CrystalVib	This modulation sound uses TheVibe to create a floating feel.
		6 Pic Chic	Perfect sound for the country in you. A little slapback delay combined with a little Comp works well.
		7 Rev Dream	ModReverb gives this sound its depth.
		8 TapeSlap	A simple rockabilly slap, but the tape delay sustained chords have a slight warbling modulation.
9 Funky Duck	AutoWah is the secret to this funky sound. Add a little SuperCho and Comp and it gets funkier!		
Professional Settings	C	0 Big Rack	The rich and clean tone of this patch resembles that made by a massive rack system. The delay mix is assigned to the pedal.
		1 RAKE	Clean sound designed for lush raked chords.
		2 TRIPY	FX style guitar for cool bridge and down sections.
		3 ACO	This acoustic sound uses the Aco.Sim effect. By using the 160 Comp, this patch can be used for playing ranging from rapid chord strokes to arpeggios.
		4 StRahht	Ethereal type sound for ambient guitars.
		5 Natural	This re-creates a natural guitar sound. Turn off its low-key reverb if you want a truly naked tone.
		6 SPAGHETTI	Spring63 and Tremolo are used in this tone that evokes a Spaghetti Western atmosphere.
		7 GardenRock	Turn this clean rock sound into a distorted sound by turning the Dist+ effect ON.
		8 CleanJazz	A mild clean tone just right for jazz.
9 YELLOW 12	This 12-string guitar sound has a 60s feel.		
Crunch	D	0 BritCombo	British style lighter crunch guitar.
		1 OJ	Great straightforward Orange amp tone.
		2 Talk Funk	Utilizing the Cry pedal and the T Scream together, you get a Frampton-like tone for some funky lead work.
		3 MS STACK	Marshall type, crunchy tone, another British style option.
		4 80s Rhythm	A classic 80's distortion tone with a touch of chorus for this perfect nostalgic sound.
		5 REC.POP	This backing sound is good for recording at home. ZNR is used to reduce noise.
		6 FAT RHYTHM	Big British style rhythm guitar.
		7 KRAVITZ	This recreates the distinctive riff sound used by Lenny Kravitz in "Are You Gonna Go My Way". Turn the Flanger ON for the interlude sound before the guitar solo.
		8 Tap Delay	Adjust the tempo to match the song when using this sound for dotted eighth note tap delay performances.
9 GIRL	This dirty rhythm guitar sound uses a NoiseGate.		
Crunch	E	0 SURF	Plenty of spring reverb for that Dick Dale tone.
		1 CLASSIC	Classic Hiwatt tone with subtle delay.
		2 B.SESSION	This setting is good for blues sessions. By using the built-in rhythm pattern, you can, for example, practice session playing by yourself.
		3 YORKE	Using the VX COMBO model, this re-creates the noted UK sound used in "Creep" by Thom Yorke, vocalist and guitarist of Radiohead.
		4 SIMPLETONE	Nice simple driven tone with subtle delay.
		5 FunkRotary	Funky auto wah with a rotary twist.
		6 WHITE	TapeEcho and Spring63 effects are used in this wet crunch sound.
		7 ORG CRUNCH	Another British tone, classic rock.
		8 VALENTINE	This sound in the style of James Valentine, the guitarist of Maroon 5, re-creates the crunchy, cutting sound with heavy compression that he uses in "This Love".
9 FILTERS	FilterDly with Delay.		

CATEGORY	BANK / PATCH	PATCH NAME	COMMENT
Professional Settings	F	0 METAL RIFF	Another bigger guitar tone for pedal single-tone lines and chug-chug riffs.
		1 Wilhelm	Heavy rock sound great for lead and rhythm parts.
		2 MUFFBIG	Big guitar sound, great for big chords, heavy rock/rock tone.
		3 Dr.Rock	Straight ahead heavy rock sound.
		4 MiracWyld	Zakk Wylde's doubling style is simulated with this metal sound.
		5 MODERN HVY	Modern style big guitar for heavier music.
		6 Gilmourish	Pretty obvious homage to a master.
		7 FOOFIGHT	This simple setting uses the BG DRIVE effect for a heavy sound in the alternative rock style of the Foo Fighters.
		8 JIMI	In the style of Jimi Hendrix, this sound calls up the spirit of Woodstock using FuzzSmile and TheVibe.
9 SpeedMetal	As its name suggests, this sound is perfect for shredding speed metal riffs.		
Professional Settings	G	0 Green BIG	Use the front pickup on the guitar with this tapping sound that is in the style of the intro to Mr. BIG's Green-Tinted Sixties Mind.
		1 LA Metal	A distortion effect is key to the flashy sound of LA metal. Add a little delay to increase the atmosphere.
		2 Shred Pick	This sound designed for rapid playing, especially full picking.
		3 Dist Hell	This is a 90s sound in the style of Pantera with emphasized highs and lows.
		4 MASSIVE LD	Big lead guitar sound with reverb.
		5 MUFFLR	GreatMuff pushed through TONE CITY with some CarbonDly creates this awesome sound.
		6 TappinHero	This volume-boosting sound is perfect for tapping. Turn the Hall ON if you want an even more pleasant tone.
		7 OCT GTR	Distorted sound good for octave playing in rock.
		8 LegatoHero	This patch is specialized for rapid legato playing. If it is still not enough for you, turn the 160 Comp effect ON!
9 GtSoloTime	This long delay sound is ideal for guitar solos.		
Professional Settings	H	0 JeanSplice	A complex sound combining four types of powerful effects that is good for beat makers and producers who want to add some guitar.
		1 BassSim	A high-quality bass simulator that can also be used to create loops.
		2 Harm	Fun auto harmony tool for guitar—don't go too crazy!
		3 POGISH	PitchSHFT combined with CoronaTri gives a gorgeous sound like a 12-string guitar.
		4 PartyViola	A slow-attack symphonic sound great for layering and adding warmth to existing guitar parts on a recording.
		5 Caverns	Soundscape evolving reverb sound.
		6 PROGRESS	This octave sound creates an eerie atmosphere with emphasized low frequencies.
		7 ARP ONE	SeqFLTR fun combined with CarbonDly.
		8 PartSpace	Delay and ParticleR through a Z Clean sound for creating an ethereal soundscape.
9 SnacMonstr	Using Octave and Cry, this sound is like an analog synth filter.		
Professional Settings	I	0 Comp Clean	This clean sound has a strong sense of compression. You can turn the amp model off to further emphasize a line input feeling.
		1 DX CRUNCH	This standby crunch sound uses the DELUXE-R effect. The dotted-eighth note delay effect at the end of the chain is OFF, ready to be turned ON when you need it.
		2 TEXAS TONE	Using the FD VIBRO effect, this crunch sound is great for Texas blues. Turn T Scream ON for a perfect lead sound.
		3 NASHVILLE	Using the US BLUES effect with some compression, this crunch sound is good for country music.
		4 MERSEYBEAT	This Beatles style crunch sound combines VX COMBO with chorus.
		5 WHITEBLUES	This is a crunch sound in the "white blues" style exemplified by Eric Clapton. Turn the Booster ON for a lead sound.
		6 BRIGHTON	Using VX JMI for a boost, this drive sound evokes 70's British rock. Turn the StereoDly ON to re-create the solo sound of Queen's Brighton Rock.
		7 CA.COMBO	This lead sound uses BG CRUNCH and features a long sustain and dense mid-frequencies.
		8 BTQ COMBO	This crunch sound creates the cabinet tone of a compact combo amp. The HD Hall effect adds a rich reverb.
9 ROCK TONE	Use the volume knob on your guitar to control this rock sound that can be transformed from clean to driven.		
Professional Settings	J	0 FuzzOrange	The combination of TANGERINE and GreatMuff effects create this alternative rock sound.
		1 OCTAVE MS	This octave guitar sound combines MS 1959 and Octave effects.
		2 REVERSE HW	HW STACK and ReverseDL together make this reverse delay sound.
		3 Guitorgan	Using the MATCH 30, Rt Closet, and Hall pedals you get the perfect leslie sound.
		4 PHASE CITY	This distorted phaser sound, which combines TONE CITY and Phaser effects, can be used to add accents to songs.
		5 MS FLANGER	MS DRIVE and Flanger are used together in this jet-like sound.
		6 DZ HEAVY	This modern high gain sound is perfect for playing heavy riffs.
		7 LA LEAD	This re-creates a rich lead tone that is indispensable to the LA sound.
		8 7strBoogie	Use this orthodox seven-string guitar and rectifier sound for a wide range of riffs from fast to groovy.
9 Power Lead	Powerful and tons of sustain! The REVO-I amp feature gets a nice hard rock lead tone.		

G1Xon

Guitar Multi-Effects Processor



Manufacturer names and product names mentioned in this patch list are trademarks or registered trademarks of their respective owners and do not indicate any affiliation with ZOOM CORPORATION.
All product and artist names are intended only to illustrate sonic characteristics that were used as reference in the development of this product.

CATEGORY	BANK / PATCH	PATCH NAME	COMMENT
Demo	A	0 MUSEUM	By combining the modern distortion of the DZ DRIVE effect with bending play using the PDL MnPit, this patch re-creates the modern UK rock sound.
		1 Duermete	Delay, reverb and chorus combine to create a dreamy atmosphere.
		2 Blue Lead	A traditional sound like you can hear in the Memphis, Tennessee, part of the blues heartland.
		3 Wakapon!	This grand wah sound uses the PedalVx effect.
		4 Down Heavy	This modern heavy sound even works with down-tuning and also cuts noise well.
		5 ChorusPad	The StereoCho effect contributes to this majestic reverb sound.
		6 PhasrFunk	The settings of this patch add the fluctuating sound of a phaser to a sharp, clean tone.
		7 Jazzy Lead	A simple smooth lead tone perfect for light smooth jazz. T Scream and Comp are combined for perfect sustain.
		8 Acoustix	The Aco.Sim was utilized to get a nice clean authentic acoustic sound. HD Hall was added for the space.
9 Supernova	This grand sound uses the ParticleR effect.		
Clean	B	0 CLEAN	All purpose clean sound with compression and reverb.
		1 CORONA	Shimmering chorus with pushed clean tone.
		2 STRATTY	Cleaner style guitar designed for single coil pickups.
		3 Clean Arp	This incredibly clean arpeggio sound uses the Aco.Sim effect. Have fun playing celebrated arpeggios with it.
		4 Just Funk	This funky sound will make you want to play rhythmically. The Spring63 effect is the key.
		5 CrystalVib	This modulation sound uses TheVibe to create a floating feel.
		6 Pic Chic	Perfect sound for the country in you. A little slapback delay combined with a little Comp works well.
		7 Rev Dream	ModReverb gives this sound its depth.
		8 TapeSlap	A simple rockabilly slap, but the tape delay sustained chords have a slight warbling modulation.
9 Funky Duck	AutoWah is the secret to this funky sound. Add a little SuperCho and Comp and it gets funkier!		
Professional Settings	C	0 Big Rack	The rich and clean tone of this patch resembles that made by a massive rack system. The delay mix is assigned to the pedal.
		1 RAKE	Clean sound designed for lush raked chords.
		2 TRIPY	FX style guitar for cool bridge and down sections.
		3 ACO	This acoustic sound uses the Aco.Sim effect. By using the 160 Comp, this patch can be used for playing ranging from rapid chord strokes to arpeggios.
		4 StRahht	Ethereal type sound for ambient guitars.
		5 Natural	This re-creates a natural guitar sound. Turn off its low-key reverb if you want a truly naked tone.
		6 SPAGHETTI	Spring63 and Tremolo are used in this tone that evokes a Spaghetti Western atmosphere.
		7 GardenRock	Turn this clean rock sound into a distorted sound by turning the Dist+ effect ON.
		8 CleanJazz	A mild clean tone just right for jazz.
9 YELLOW 12	This 12-string guitar sound has a 60s feel.		
Crunch	D	0 BritCombo	British style lighter crunch guitar.
		1 OJ	Great straightforward Orange amp tone.
		2 Talk Funk	Utilizing the Cry pedal and the T Scream together, you get a Frampton-like tone for some funky lead work.
		3 MS STACK	Marshall type, crunchy tone, another British style option.
		4 80s Rhythm	A classic 80s distortion tone with a touch of chorus for this perfect nostalgic sound.
		5 REC.POP	This backing sound is good for recording at home. ZNR is used to reduce noise.
		6 FAT RHYTHM	Big British style rhythm guitar.
		7 KRAVITZ	This recreates the distinctive riff sound used by Lenny Kravitz in "Are You Gonna Go My Way". Turn the Flanger ON for the interlude sound before the guitar solo.
		8 Tap Delay	Adjust the tempo to match the song when using this sound for dotted eighth note tap delay performances.
9 GIRL	This dirty rhythm guitar sound uses a NoiseGate.		
	E	0 SURF	Plenty of spring reverb for that Dick Dale tone.
		1 CLASSIC	Classic Hiwatt tone with subtle delay.
		2 B.SESSION	This setting is good for blues sessions. By using the built-in rhythm pattern, you can, for example, practice session playing by yourself.
		3 YORKE	Using the VX COMBO model, this re-creates the noted UK sound used in "Creep" by Thom Yorke, vocalist and guitarist of Radiohead.
		4 SIMPLETONE	Nice simple driven tone with subtle delay.
		5 FunkRotary	Funky auto wah with a rotary twist.
		6 WHITE	TapeEcho and Spring63 effects are used in this wet crunch sound.
		7 ORG CRUNCH	Another British tone, classic rock.
		8 VALENTINE	This sound in the style of James Valentine, the guitarist of Maroon 5, re-creates the crunchy, cutting sound with heavy compression that he uses in "This Love".
9 FILTERS	FilterDly with Delay.		

CATEGORY	BANK / PATCH	PATCH NAME	COMMENT
Professional Settings	F	0 METAL RIFF	Another bigger guitar tone for pedal single-tone lines and chug-chug riffs.
		1 Wilhelm	Heavy rock sound great for lead and rhythm parts.
		2 MUFFBIG	Big guitar sound, great for big chords, heavy rock/rock tone.
		3 Dr.Rock	Straight ahead heavy rock sound.
		4 MiracWyld	Zakk Wylde's doubling style is simulated with this metal sound.
		5 MODERN HVY	Modern style big guitar for heavier music.
		6 Gilmourish	Pretty obvious homage to a master.
		7 FOOFIGHT	This simple setting uses the BG DRIVE effect for a heavy sound in the alternative rock style of the Foo Fighters.
		8 JIMI	In the style of Jimi Hendrix, this sound calls up the spirit of Woodstock using FuzzSmile and TheVibe.
9 SpeedMetal	As its name suggests, this sound is perfect for shredding speed metal riffs.		
High Gain	G	0 Green BIG	Use the front pickup on the guitar with this tapping sound that is in the style of the intro to Mr. BIG's Green-Tinted Sixties Mind.
		1 LA Metal	A distortion effect is key to the flashy sound of LA metal. Add a little delay to increase the atmosphere.
		2 Shred Pick	This sound designed for rapid playing, especially full picking.
		3 BIGWAH	Big guitar wah sound for solos, leads and shredding.
		4 MASSIVE LD	Big lead guitar sound with reverb.
		5 MUFFLR	GreatMuff pushed through TONE CITY with some CarbonDly creates this awesome sound.
		6 TappinHero	This volume-boosting sound is perfect for tapping. Turn the Hall ON if you want an even more pleasant tone.
		7 OCT GTR	Distorted sound good for octave playing in rock.
		8 LegatoHero	This patch is specialized for rapid legato playing. If it is still not enough for you, turn the 160 Comp effect ON!
9 GtSoloTime	This long delay sound is ideal for guitar solos.		
Tweak Freak	H	0 JeanSplice	A complex sound combining four types of powerful effects that is good for beat makers and producers who want to add some guitar.
		1 BassSim	A high-quality bass simulator that can also be used to create loops.
		2 Harm	Fun auto harmony tool for guitar—don't go too crazy!
		3 POGISH	PitchSHFT combined with CoronaTri gives a gorgeous sound like a 12-string guitar.
		4 PartyViola	A slow-attack symphonic sound great for layering and adding warmth to existing guitar parts on a recording.
		5 Caverns	Soundscape evolving reverb sound.
		6 PROGRESS	This octave sound creates an eerie atmosphere with emphasized low frequencies.
		7 ARP ONE	SeqFLTR fun combined with CarbonDly.
		8 PartSpace	Delay and ParticleR through a Z Clean sound for creating an ethereal soundscape.
9 SnacMonstr	Using Octave and Cry, this sound is like an analog synth filter.		
Legendary Tone	I	0 Comp Clean	This clean sound has a strong sense of compression. You can turn the amp model off to further emphasize a line input feeling.
		1 DX CRUNCH	This standby crunch sound uses the DELUXE-R effect. The dotted-eighth note delay effect at the end of the chain is OFF, ready to be turned ON when you need it.
		2 TEXAS TONE	Using the FD VIBRO effect, this crunch sound is great for Texas blues. Turn T Scream ON for a perfect lead sound.
		3 NASHVILLE	Using the US BLUES effect with some compression, this crunch sound is good for country music.
		4 MERSEYBEAT	This Beatles style crunch sound combines VX COMBO with chorus.
		5 WHITEBLUES	This is a crunch sound in the "white blues" style exemplified by Eric Clapton. Turn the Booster ON for a lead sound.
		6 BRIGHTON	Using VX JMI for a boost, this drive sound evokes 70s British rock. Turn the StereoDly ON to re-create the solo sound of Queen's Brighton Rock.
		7 CA.COMBO	This lead sound uses BG CRUNCH and features a long sustain and dense mid-frequencies.
		8 BTQ COMBO	This crunch sound creates the cabinet tone of a compact combo amp. The HD Hall effect adds a rich reverb.
9 ROCK TONE	Use the volume knob on your guitar to control this rock sound that can be transformed from clean to driven.		
	J	0 FuzzOrange	The combination of TANGERINE and GreatMuff effects create this alternative rock sound.
		1 OCTAVE MS	This octave guitar sound combines MS 1959 and Octave effects.
		2 REVERSE HW	HW STACK and ReverseDL together make this reverse delay sound.
		3 Guitorgan	Using the MATCH 30, Rt Closet, and Hall pedals you get the perfect leslie sound.
		4 PHASE CITY	This distorted phaser sound, which combines TONE CITY and Phaser effects, can be used to add accents to songs.
		5 MS FLANGER	MS DRIVE and Flanger are used together in this jet-like sound.
		6 DZ HEAVY	This modern high gain sound is perfect for playing heavy riffs.
		7 LA LEAD	This re-creates a rich lead tone that is indispensable to the LA sound.
		8 7strBoogie	Use this orthodox seven-string guitar and rectifier sound for a wide range of riffs from fast to groovy.
9 Power Lead	Powerful and tons of sustain! The REVO-I amp feature gets a nice hard rock lead tone.		