



Tour™ Series TNT Combo Tour™ Series TKO Combo

Bass Amplifiers

Operating
Manual





Intended to alert the user to the presence of uninsulated “dangerous voltage” within the product’s enclosure that may be of sufficient magnitude to constitute a risk of electric shock to persons.



Intended to alert the user of the presence of important operating and maintenance (servicing) instructions in the literature accompanying the product.

CAUTION: Risk of electrical shock — DO NOT OPEN!

CAUTION: To reduce the risk of electric shock, do not remove cover. No user serviceable parts inside. Refer servicing to qualified service personnel.

WARNING: To prevent electrical shock or fire hazard, this apparatus should not be exposed to rain or moisture, and objects filled with liquids, such as vases, should not be placed on this apparatus. Before using this apparatus, read the operating guide for further warnings.



Este símbolo tiene el propósito, de alertar al usuario de la presencia de “(voltaje) peligroso” sin aislamiento dentro de la caja del producto y que puede tener una magnitud suficiente como para constituir riesgo de descarga eléctrica.



Este símbolo tiene el propósito de alertar al usuario de la presencia de instrucciones importantes sobre la operación y mantenimiento en la información que viene con el producto.

PRECAUCION: Riesgo de descarga eléctrica ¡NO ABRIR!

PRECAUCION: Para disminuir el riesgo de descarga eléctrica, no abra la cubierta. No hay piezas útiles dentro. Deje todo mantenimiento en manos del personal técnico cualificado.

ADVERTENCIA: Para prevenir choque eléctrico o riesgo de incendios, este aparato no se debe exponer a la lluvia o a la humedad. Los objetos llenos de líquidos, como los floreros, no se deben colocar encima de este aparato. Antes de usar este aparato, lea la guía de funcionamiento para otras advertencias.



Ce symbole est utilisé dans ce manuel pour indiquer à l'utilisateur la présence d'une tension dangereuse pouvant être d'amplitude suffisante pour constituer un risque de choc électrique.



Ce symbole est utilisé dans ce manuel pour indiquer à l'utilisateur qu'il ou qu'elle trouvera d'importantes instructions concernant l'utilisation et l'entretien de l'appareil dans le paragraphe signalé.

ATTENTION: Risques de choc électrique — NE PAS OUVRIR!

ATTENTION: Afin de réduire le risque de choc électrique, ne pas enlever le couvercle. Il ne se trouve à l'intérieur aucune pièce pouvant être réparée par l'utilisateur. Confiez l'entretien et la réparation de l'appareil à un réparateur Peavey agréé.

AVIS: Dans le but de réduire les risques d'incendie ou de décharge électrique, cet appareil ne doit pas être exposé à la pluie ou à l'humidité et aucun objet rempli de liquide, tel qu'un vase, ne doit être posé sur celui-ci. Avant d'utiliser de cet appareil, lisez attentivement le guide fonctionnant pour avertissements supplémentaires.



Dieses Symbol soll den Anwender vor unisolierten gefährlichen Spannungen innerhalb des Gehäuses warnen, die von Ausreichender Stärke sind, um einen elektrischen Schlag verursachen zu können.



Dieses Symbol soll den Benutzer auf wichtige Instruktionen in der Bedienungsanleitung aufmerksam machen, die Handhabung und Wartung des Produkts betreffen.

VORSICHT: Risiko — Elektrischer Schlag! Nicht öffnen!

VORSICHT: Um das Risiko eines elektrischen Schlages zu vermeiden, nicht die Abdeckung entfernen. Es befinden sich keine Teile darin, die vom Anwender repariert werden könnten. Reparaturen nur von qualifiziertem Fachpersonal durchführen lassen.

WARNUNG: Um elektrischen Schlag oder Brandgefahr zu verhindern, sollte dieser Apparat nicht Regen oder Feuchtigkeit ausgesetzt werden und Gegenstände mit Flüssigkeiten gefüllt, wie Vasen, nicht auf diesen Apparat gesetzt werden. Bevor dieser Apparat verwendet wird, lesen Sie bitte den Funktionsführer für weitere Warnungen.

IMPORTANT SAFETY INSTRUCTIONS

WARNING: When using electrical products, basic cautions should always be followed, including the following:



1. Read these instructions.
2. Keep these instructions.
3. Heed all warnings.
4. Follow all instructions.
5. Do not use this apparatus near water.
6. Clean only with a dry cloth.
7. Do not block any of the ventilation openings. Install in accordance with manufacturer's instructions.
8. Do not install near any heat sources such as radiators, heat registers, stoves or other apparatus (including amplifiers) that produce heat.
9. Do not defeat the safety purpose of the polarized or grounding-type plug. A polarized plug has two blades with one wider than the other. A grounding type plug has two blades and a third grounding plug. The wide blade or third prong is provided for your safety. If the provided plug does not fit into your outlet, consult an electrician for replacement of the obsolete outlet.
10. Protect the power cord from being walked on or pinched, particularly at plugs, convenience receptacles, and the point they exit from the apparatus.
11. Only use attachments/accessories provided by the manufacturer.
12. Use only with a cart, stand, tripod, bracket, or table specified by the manufacturer, or sold with the apparatus. When a cart is used, use caution when moving the cart/apparatus combination to avoid injury from tip-over.
13.  Unplug this apparatus during lightning storms or when unused for long periods of time.
14. Refer all servicing to qualified service personnel. Servicing is required when the apparatus has been damaged in any way, such as power-supply cord or plug is damaged, liquid has been spilled or objects have fallen into the apparatus, the apparatus has been exposed to rain or moisture, does not operate normally, or has been dropped.
15. Never break off the ground pin. Write for our free booklet "Shock Hazard and Grounding." Connect only to a power supply of the type marked on the unit adjacent to the power supply cord.
16. If this product is to be mounted in an equipment rack, rear support should be provided.
17. Note for UK only: If the colors of the wires in the mains lead of this unit do not correspond with the terminals in your plug, proceed as follows:
 - a) The wire that is colored green and yellow must be connected to the terminal that is marked by the letter E, the earth symbol, colored green or colored green and yellow.
 - b) The wire that is colored blue must be connected to the terminal that is marked with the letter N or the color black.
 - c) The wire that is colored brown must be connected to the terminal that is marked with the letter L or the color red.
18. This electrical apparatus should not be exposed to dripping or splashing and care should be taken not to place objects containing liquids, such as vases, upon the apparatus.
19. The on/off switch in this unit does not break both sides of the primary mains. Hazardous energy can be present inside the chassis when the on/off switch is in the off position. The mains plug or appliance coupler is used as the disconnect device, the disconnect device shall remain readily operable.
20. Exposure to extremely high noise levels may cause a permanent hearing loss. Individuals vary considerably in susceptibility to noise-induced hearing loss, but nearly everyone will lose some hearing if exposed to sufficiently intense noise for a sufficient time. The U.S. Government's Occupational Safety and Health Administration (OSHA) has specified the following permissible noise level exposures:

Duration Per Day In Hours	Sound Level dBA, Slow Response
8	90
6	92
4	95
3	97
2	100
1 1/2	102
1	105
1/2	110
1/4 or less	115

According to OSHA, any exposure in excess of the above permissible limits could result in some hearing loss. Ear plugs or protectors to the ear canals or over the ears must be worn when operating this amplification system in order to prevent a permanent hearing loss, if exposure is in excess of the limits as set forth above. To ensure against potentially dangerous exposure to high sound pressure levels, it is recommended that all persons exposed to equipment capable of producing high sound pressure levels such as this amplification system be protected by hearing protectors while this unit is in operation.

SAVE THESE INSTRUCTIONS!

WICHTIGE SICHERHEITSHINWEISE

ACHTUNG: Beim Einsatz von Elektrogeräten müssen u.a. grundlegende Vorsichtsmaßnahmen befolgt werden:



1. Lesen Sie sich diese Anweisungen durch.
2. Bewahren Sie diese Anweisungen auf.
3. Beachten Sie alle Warnungen.
4. Befolgen Sie alle Anweisungen.
5. Setzen Sie dieses Gerät nicht in der Nähe von Wasser ein.
6. Reinigen Sie es nur mit einem trockenen Tuch.
7. Blockieren Sie keine der Lüftungsöffnungen. Führen Sie die Installation gemäß den Anweisungen des Herstellers durch.
8. Installieren Sie das Gerät nicht neben Wärmequellen wie Heizungen, Heizgeräten, Öfen oder anderen Geräten (auch Verstärkern), die Wärme erzeugen.
9. Beeinträchtigen Sie nicht die Sicherheitswirkung des gepolten Steckers bzw. des Erdungssteckers. Ein gepolter Stecker weist zwei Stifte auf, von denen einer breiter ist als der andere. Ein Erdungsstecker weist zwei Stifte und einen dritten Erdungsstift auf. Der breite Stift bzw. der dritte Stift dient Ihrer Sicherheit. Sollte der beiliegende Stecker nicht in Ihre Steckdose passen, wenden Sie sich bitte an einen Elektriker, um die ungeeignete Steckdose austauschen zu lassen.
10. Schützen Sie das Netzkabel, sodass niemand darauf tritt oder es geknickt wird, insbesondere an Steckern oder Buchsen und ihren Austrittsstellen aus dem Gerät.
11. Verwenden Sie nur die vom Hersteller erhältlichen Zubehörgeräte oder Zubehörteile.
12.  Verwenden Sie nur einen Wagen, Stativ, Dreifuß, Träger oder Tisch, der den Angaben des Herstellers entspricht oder zusammen mit dem Gerät verkauft wurde. Wird ein Wagen verwendet, bewegen Sie den Wagen mit dem darauf befindlichen Gerät besonders vorsichtig, damit er nicht umkippt und möglicherweise jemand verletzt wird.
13. Trennen Sie das Gerät während eines Gewitters oder während längerer Zeiträume, in denen es nicht benutzt wird, von der Stromversorgung.
14. Lassen Sie sämtliche Wartungsarbeiten von qualifizierten Kundendiensttechnikern durchführen. Eine Wartung ist erforderlich, wenn das Gerät in irgendeiner Art beschädigt wurde, etwa wenn das Netzkabel oder der Netzstecker beschädigt wurden, Flüssigkeit oder Gegenstände in das Gerät gelangt sind, das Gerät Regen oder Feuchtigkeit ausgesetzt wurde, nicht normal arbeitet oder heruntergefallen ist.
15. Der Erdungsstift darf nie entfernt werden. Auf Wunsch senden wir Ihnen gerne unsere kostenlose Broschüre „Shock Hazard and Grounding“ (Gefahr durch elektrischen Schlag und Erdung) zu. Schließen Sie nur an die Stromversorgung der Art an, die am Gerät neben dem Netzkabel angegeben ist.
16. Wenn dieses Produkt in ein Geräte-Rack eingebaut werden soll, muss eine Versorgung über die Rückseite eingerichtet werden.
17. Hinweis – Nur für Großbritannien: Sollte die Farbe der Drähte in der Netzleitung dieses Geräts nicht mit den Klemmen in Ihrem Stecker übereinstimmen, gehen Sie folgendermaßen vor:
 - a) Der grün-gelbe Draht muss an die mit E (Symbol für Erde) markierte bzw. grüne oder grün-gelbe Klemme angeschlossen werden.
 - b) Der blaue Draht muss an die mit N markierte bzw. schwarze Klemme angeschlossen werden.
 - c) Der braune Draht muss an die mit L markierte bzw. rote Klemme angeschlossen werden.
18. Dieses Gerät darf nicht ungeschützt Wassertropfen und Wasserspritzern ausgesetzt werden und es muss darauf geachtet werden, dass keine mit Flüssigkeiten gefüllte Gegenstände, wie z. B. Blumenvasen, auf dem Gerät abgestellt werden.
19. Der Netzschalter in dieser Einheit bricht beide Seiten von den primären Hauptleitungen nicht. Gefährliche Energie kann anwesend innerhalb des Chassis sein, wenn her Netzschalter im ab Poistion ist. Die Hauptleitungen stöpseln zu oder Gerätkupplung ist benutzt, während das Vorrichtung abschaltet, das schaltet Vorrichtung wird bleiben sogleich hantierbar ab.
20. Belastung durch extrem hohe Lärmpegel kann zu dauerhaftem Gehörverlust führen. Die Anfälligkeit für durch Lärm bedingten Gehörverlust ist von Mensch zu Mensch verschieden, das Gehör wird jedoch bei jedem in gewissem Maße geschädigt, der über einen bestimmten Zeitraum ausreichend starkem Lärm ausgesetzt ist. Die US-Arbeitsschutzbehörde (Occupational and Health Administration, OSHA) hat die folgenden zulässigen Pegel für Lärmbelastung festgelegt:

Dauer pro Tag in Stunden	Geräuschpegel dBA, langsame Reaktion
8	90
6	92
4	95
3	97
2	100
1 1/2	102
1	105
1/2	110
1/4 oder weniger	115

Laut OSHA kann jede Belastung über den obenstehenden zulässigen Grenzwerten zu einem gewissen Gehörverlust führen. Sollte die Belastung die obenstehenden Grenzwerte übersteigen, müssen beim Betrieb dieses Verstärkungssystems Ohrenstopfen oder Schutzhörgeräte im Gehörgang oder über den Ohren getragen werden, um einen dauerhaften Gehörverlust zu verhindern. Um sich vor einer möglicherweise gefährlichen Belastung durch hohe Schalldruckpegel zu schützen, wird allen Personen empfohlen, die mit Geräten arbeiten, die wie dieses Verstärkungssystem hohe Schalldruckpegel erzeugen können, beim Betrieb dieses Geräts einen Gehörschutz zu tragen.

BEWAHREN SIE DIESE SICHERHEITSHINWEISE AUF!

INSTRUCTIONS IMPORTANTES DE SECURITE

ATTENTION: L'utilisation de tout appareil électrique doit être soumise aux précautions d'usage incluant:



1. Lire ces instructions.
2. Gardez ce manuel pour de futures références.
3. Prêtez attention aux messages de précautions de ce manuel.
4. Suivez ces instructions.
5. N'utilisez pas cette unité proche de plans d'eau.
6. N'utilisez qu'un tissu sec pour le nettoyage de votre unité.
7. N'obstruez pas les systèmes de refroidissement de votre unité et installez votre unité en fonction des instructions de ce manuel.
8. Ne positionnez pas votre unité à proximité de toute source de chaleur.
9. Connectez toujours votre unité sur une alimentation munie de prise de terre utilisant le cordon d'alimentation fourni.
10. Protégez les connecteurs de votre unité et positionnez les cablages pour éviter toutes déconnexions accidentelles.
11. N'utilisez que des fixations approuvées par le fabriquant.
12. Lors de l'utilisation sur pied ou poteau de support, assurez dans le cas de déplacement de l'ensemble enceinte/support de prévenir tout basculement intempestif de celui-ci.
13.  Il est conseillé de déconnecter du secteur votre unité en cas d'orage ou de durée prolongée sans utilisation.
14. Seul un technicien agréé par le fabriquant est à même de réparer/contrôler votre unité. Celle-ci doit être contrôlée si elle a subi des dommages de manipulation, d'utilisation ou de stockage (humidité,...).
15. Ne déconnectez jamais la prise de terre de votre unité.
16. Si votre unité est destinée à être montée en rack, des supports arrière doivent être utilisés.
17. Note pour les Royaumes-Unis: Si les couleurs de connecteurs du câble d'alimentation ne correspondent pas au guide de la prise secteur, procédez comme suit:
 - a) Le connecteur vert et jaune doit être connecté au terminal noté E, indiquant la prise de terre ou correspondant aux couleurs verte ou verte et jaune du guide.
 - b) Le connecteur Bleu doit être connecté au terminal noté N, correspondant à la couleur noire du guide.
 - c) Le connecteur marron doit être connecté au terminal noté L, correspondant à la couleur rouge du guide.
18. Cet équipement électrique ne doit en aucun cas être en contact avec un quelconque liquide et aucun objet contenant un liquide, vase ou autre ne devrait être posé sur celui-ci.
19. L'interrupteur (on-off) dans cette unité ne casse pas les deux côtés du primaire principal. L'énergie hasardeuse peut être présente dans le châssis quand l'interrupteur (on-off) est dans la position. Le bouchon principal ou atelage d'appareil est utilisé comme le débrancher l'appareil restera facilement opérable.
20. Une exposition à de hauts niveaux sonores peut conduire à des dommages de l'écoute irréversibles. La susceptibilité au bruit varie considérablement d'un individu à l'autre, mais une large majorité de la population expérimentera une perte de l'écoute après une exposition à une forte puissance sonore pour une durée prolongée. L'organisme de la santé américaine (OSHA) a produit le guide ci-dessous en rapport à la perte occasionnée:

Durée par Jour (heures)	Niveau sonore moyen (dBA)
8	90
6	92
4	95
3	97
2	100
1 1/2	102
1	105
1/2	110
1/4 ou inférieur	115

D'après les études menées par le OSHA, toute exposition au delà des limites décrites ci-dessus entraînera des pertes de l'écoute chez la plupart des sujets. Le port de système de protection (casque, oreillette de filtrage,...) doit être observé lors de l'opération cette unité ou des dommages irréversibles peuvent être occasionnés. Le port de ces systèmes doit être observé par toutes personnes susceptibles d'être exposées à des conditions au delà des limites décrites ci-dessus.

GARDEZ CES INSTRUCTIONS!

INSTRUCCIONES IMPORTANTES PARA SU SEGURIDAD

CUIDADO: Cuando use productos electrónicos, debe tomar precauciones básicas, incluyendo las siguientes:



1. Lea estas instrucciones.
2. Guarde estas instrucciones.
3. Haga caso de todos los consejos.
4. Siga todas las instrucciones.
5. No usar este aparato cerca del agua.
6. Limpiar solamente con una tela seca.
7. No bloquear ninguna de las salidas de ventilación. Instalar de acuerdo a las instrucciones del fabricante.
8. No instalar cerca de ninguna fuente de calor como radiadores, estufas, hornos u otros aparatos (incluyendo amplificadores) que produzcan calor.
9. No retire la patilla protectora del enchufe polarizado o de tipo "a Tierra". Un enchufe polarizado tiene dos puntas, una de ellas más ancha que la otra. Un enchufe de tipo "a Tierra" tiene dos puntas y una tercera "a Tierra". La punta ancha (la tercera) se proporciona para su seguridad. Si el enchufe proporcionado no encaja en su enchufe de red, consulte a un electricista para que reemplaze su enchufe obsoleto.
10. Proteja el cable de alimentación para que no sea pisado o pinchado, particularmente en los enchufes, huecos, y los puntos que salen del aparato.
11. Usar solamente añadidos/accesorios proporcionados por el fabricante.
12. Usar solamente un carro, pie, trípode, o soporte especificado por el fabricante, o vendido junto al aparato. Cuando se use un carro, tenga cuidado al mover el conjunto carro/aparato para evitar que se dañe en un vuelco. No suspenda esta caja de ninguna manera.
13. Desenchufe este aparato durante tormentas o cuando no sea usado durante largos periodos de tiempo.
14. Para cualquier reparación, acuda a personal de servicio cualificado. Se requieren reparaciones cuando el aparato ha sido dañado de alguna manera, como cuando el cable de alimentación o el enchufe se han dañado, algún líquido ha sido derramado o algún objeto ha caído dentro del aparato, el aparato ha sido expuesto a la lluvia o la humedad, no funciona de manera normal, o ha sufrido una caída.
15. Nunca retire la patilla de Tierra. Escríbanos para obtener nuestro folleto gratuito "Shock Hazard and Grounding" ("Peligro de Electrocuación y Toma a Tierra"). Conecte el aparato sólo a una fuente de alimentación del tipo marcado al lado del cable de alimentación.
16. Si este producto va a ser enracado con más equipo, use algún tipo de apoyo trasero.
17. Nota para el Reino Unido solamente: Si los colores de los cables en el enchufe principal de esta unidad no corresponden con los terminales en su enchufe, proceda de la siguiente manera:
 - a) El cable de color verde y azul debe ser conectado al terminal que está marcado con la letra E, el símbolo de Tierra (earth), coloreado en verde o en verde y amarillo.
 - b) El cable coloreado en azul debe ser conectado al terminal que está marcado con la letra N o el color negro.
 - c) El cable coloreado en marrón debe ser conectado al terminal que está marcado con la letra L o el color rojo.
18. Este aparato eléctrico no debe ser sometido a ningún tipo de goteo o salpicadura y se debe tener cuidado para no poner objetos que contengan líquidos, como vasos, sobre el aparato.
19. El interruptor de en/lejos en esta unidad no rompe ambos lados de la red primaria. La energía peligrosa puede ser presente dentro del chasis cuando el interruptor de en/lejos está en el de la posición. El tapón de la red o el acoplador del aparato son utilizados como el desconecta dispositivo, el desconecta dispositivo se quedará fácilmente operable.
20. La exposición a altos niveles de ruido puede causar una pérdida permanente en la audición. La susceptibilidad a la pérdida de audición provocada por el ruido varía según la persona, pero casi todo el mundo perderá algo de audición si se expone a un nivel de ruido suficientemente intenso durante un tiempo determinado. El Departamento para la Salud y para la Seguridad del Gobierno de los Estados Unidos (OSHA) ha especificado las siguientes exposiciones al ruido permisibles:

Duración por Día en Horas	Nivel de Sonido dBA, Respuesta Lenta
8	90
6	92
4	95
3	97
2	100
1 1/2	102
1	105
1/2	110
1/4 o menos	115

De acuerdo al OSHA, cualquier exposición que exceda los límites arriba indicados puede producir algún tipo de pérdida en la audición. Protectores para los canales auditivos o tapones para los oídos deben ser usados cuando se opere con este sistema de sonido para prevenir una pérdida permanente en la audición, si la exposición excede los límites indicados más arriba. Para protegerse de una exposición a altos niveles de sonido potencialmente peligrosa, se recomienda que todas las personas expuestas a equipamiento capaz de producir altos niveles de presión sonora, tales como este sistema de amplificación, se encuentren protegidas por protectores auditivos mientras esta unidad esté operando.

GUARDE ESTAS INSTRUCCIONES!

Tour™ Series TNT & TKO Combos

Bass Amplifiers

Welcome to Peavey® bass amplification!

Peavey bass guitar amplifiers are legendary for their state of the art features, class-leading power, superb tone, and unmatched reliability. Your new Tour series TKO or TNT is no exception. Peavey's award-winning Tour series amplifiers provide the backbone for countless touring acts worldwide. Peavey TKO and TNT combos have set the standard for bass combo performance over three decades. Your Tour series edition features a class D power amp, custom-designed 15" bass driver, built-in tweeter, and a tilt-back cabinet design that will push your tone to the back of the house, while still delivering great low-volume practice and studio performance. Your amp is not only versatile with its powerful EQ and tone controls, it's expandable with the extension speaker output on the back, should the need for higher volume levels arise. If you are a TNT owner, you will love the built-in optical compressor and vintage crunch effect. TKO users will love the easy to use controls and modern cabinet styling.

Please read this guide carefully to ensure your personal safety as well as the safety of your amplifier.

FEATURES:

- Bypassable 7-band graphic equalizer with push-button bypass
- Class D Power Section
- Patented DDT™ (Distortion Detection Technique) technology
- Built-In Crunch effect (TNT)
- Tweeter On/Off switch (TNT)
- Studio quality balanced DI output
- Built-in Optical compressor
- Buffered Effects Loop
- Speakon® combination Powered Speaker Output (1/4" on TKO)
- Active/Passive Instrument Switch
- Pre and Post Gain controls
- Low & High Shelving EQ
- Contour Control



VENTILATION: For proper ventilation, allow 12" clearance from the nearest combustible surface.

All vents should have a minimum of 2" of free air space so air can flow thru the unit freely for proper cooling.

TNT Front Panel

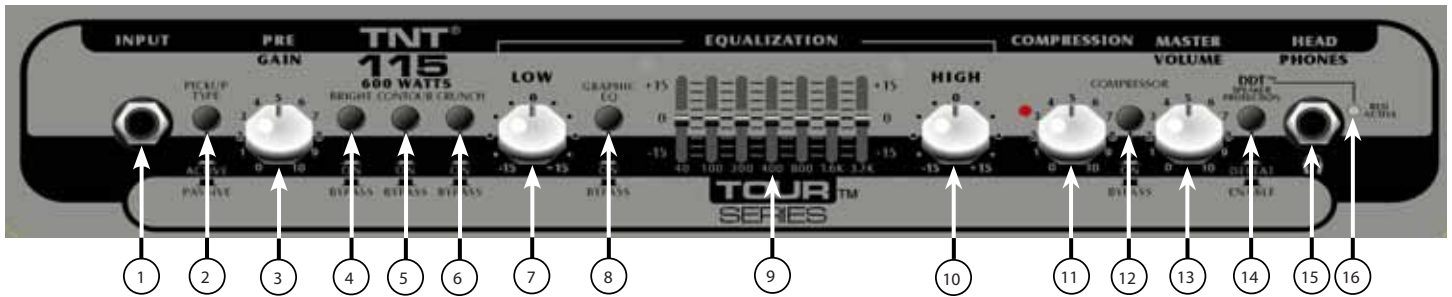

- 1 INPUT
1/4" Instrument Input WARNING: Never plug the output of a power amplifier into the input jacks. Damage may occur to both units.
- 2 ACTIVE/PASSIVE PICKUP SWITCH
This switch is included so you can choose the appropriate setting for your instrument. Passive pickups have a lower output, so the gain structure of the amplifier is modified to accommodate the different pickup configurations.
- 3 PRE GAIN
This knob controls input level of the instrument.
- 4 BRIGHT SWITCH
This button provides a 10 dB boost to frequencies above 1KHz. To activate, depress the switch to its "IN" position.
- 5 CONTOUR
This button boosts highs and lows while simultaneously cutting mid tones producing a "scooped" sound.
- 6 CRUNCH SWITCH
This button engages a crunch effect, simulating the classic overdriven tube amp sound.
- 7 LOW
This knob provides a shelving tone control for low frequencies and provides cut/boost of +/-15 dB. The center point is flat. The center frequency is 50 Hz. -3 dB shelf corner frequency is 100Hz.
- 8 EQ BYPASS
This button removes the graphic equalizer from the audio chain. The "OUT" position of the switch bypasses the EQ, and the amp will respond as if the graphic equalizer is set flat.
- 9 GRAPHIC EQUALIZER
These sliders provide precise tone control through the constant-Q, seven band equalizer. Each band may be boosted or cut 15 dB.
- 10 HIGH
This knob provides a shelving tone control for high frequencies and cut/boost of +/-15dB. The center point is flat and the frequency is 8 KHz. -3dB; the shelf corner frequency is 5 KHz.
- 11 COMPRESSOR
Rotating this knob clockwise will increase the amount of compression in the signal chain.

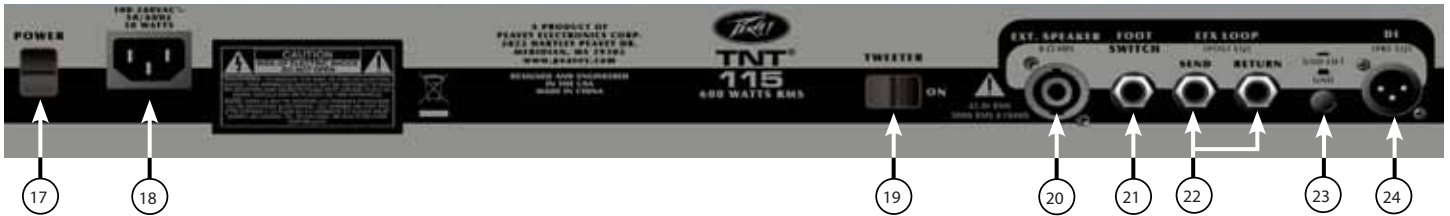

12 COMPRESSOR ON/OFF SWITCH

This button turns the compressor on or off.

13 VOLUME

This knob controls the overall volume of the amplifier.

14 DDT™ (Distortion Detection Technique)

This button prevents power amplifier clipping that can sound bad and damage speakers. The "IN" or "DEFEAT" position of the switch bypasses the DDT circuit. However, Peavey® recommends the DDT stay enabled for optimum system performance.

15 HEADPHONE OUTPUT

1/4" headphone output for personal monitoring.

16 DDT INDICATOR LIGHT

When the DDT is enabled, the Protect/Clip LED will flash when DDT is triggered. It is normal operation for the LED to flash. However, if the LED is constantly illuminated, the gain level needs to be adjusted to prevent possible equipment damage. When the DDT is defeated, the LED becomes a clip indicator.

17 POWER SWITCH

To apply power to the unit, flip the switch to the "On" position. The blue LED will illuminate, indicating power is being supplied.



Caution: The on/off switch in this unit does not break both sides of the primary mains. Hazardous energy can be present inside the chassis even when the on/off switch is in the OFF position.

18 AC POWER INLET:



This is the receptacle for an IEC line cord, which provides AC power to the unit. Connect the line cord to this connector to provide power to the unit. Damage to the equipment may result if improper line voltage is used. (See line voltage marking on unit).



Never break off the ground pin on any equipment. It is provided for your safety. If the outlet used does not have a ground pin, a suitable grounding adapter should be used, and the third wire should be grounded properly. To prevent the risk of shock or fire hazard, always make sure that the amplifier and all associated equipment is properly grounded.



NOTE: FOR UK ONLY

As the colors of the wires in the mains lead of this apparatus may not correspond with the colored markings identifying the terminals in your plug, proceed as follows: (1) The wire that is colored green and yellow must be connected to the terminal that is marked by the letter E, or by the Earth symbol, or colored green or green and yellow. (2) The wire that is colored blue must be connected to the terminal that is marked with the letter N, or the color black. (3) The wire that is colored brown must be connected to the terminal that is marked with the letter L, or the color red.

- 19 TWEETER SWITCH
This switch turns the tweeter on/off. Usually when the CRUNCH effect is engaged, this switch would be switched to the OFF position.
- 20 EXTERNAL SPEAKER OUTPUT
Speakon™ type powered output for powering a passive enclosure.
- 21 FOOTSWITCH JACK
Plug your TNT footswitch into this 1/4" jack. The footswitch controls the crunch effect and the compressor on/off. NOTE: The crunch and compressor buttons MUST be pushed in to operate with the footswitch.
- 22 EFFECTS LOOP
The Send Jack provides a pre amp output that may be used to drive slave amplifiers and external effects processors. The Return Jack provides a power amp input for the last effect in the chain. NOTE: When using the unit as a slave power amplifier, the Return Jack should be used as the input.
- 23 GROUND LIFT
This button is provided to prevent a ground loop that may result in "hum" noise. When depressed (IN position), Ground Lift is engaged.
- 24 DIRECT INTERFACE (DI)
This is a built-in, balanced Direct Interface is used to send a buffered, unprocessed signal to an external mixer.

Front Panel

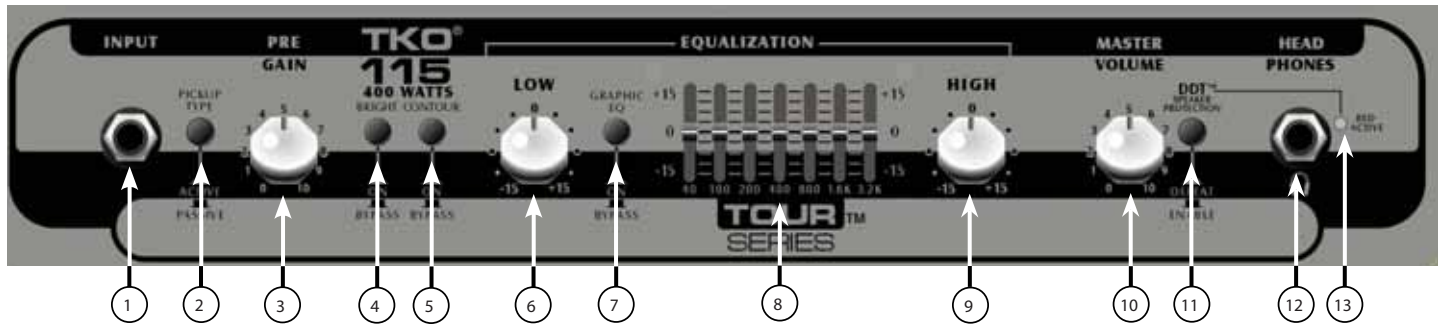

- 1 INPUT
1/4" Instrument Input WARNING: Never plug the output of a power amplifier into the input jacks. Damage may occur to both units.
- 2 ACTIVE/PASSIVE PICKUP SWITCH
This switch is included so you can choose the appropriate setting for your instrument. Passive pickups have a lower output, so the gain structure of the amplifier is modified to accommodate the different pickup configurations.
- 3 PRE GAIN
This knob controls input level of the instrument.
- 4 BRIGHT SWITCH
This button provides a 10 dB boost to frequencies above 1KHz. To activate, depress the switch to its "IN" position.
- 5 CONTOUR
This button boosts highs and lows while simultaneously cutting mid tones producing a "scooped" sound.
- 6 LOW
This knob provides a shelving tone control for low frequencies and provides cut/boost of +/-15 dB. The center point is flat. The center frequency is 50 Hz. -3 dB shelf corner frequency is 100Hz.
- 7 EQ BYPASS
This button removes the graphic equalizer from the audio chain. The "IN" position of the switch bypasses the EQ, and the amp will respond as if the graphic equalizer is set flat.
- 8 GRAPHIC EQUALIZER
These sliders provide precise tone control through the constant-Q, nine band equalizer. Each band may be boosted or cut 15 dB.
- 9 HIGH
This knob provides a shelving tone control for high frequencies and cut/boost of +/-15dB. The center point is flat and the frequency is 8 KHz. -3dB; the shelf corner frequency is 5 KHz.
- 10 MASTER VOLUME
This knob controls the overall volume of the amplifier.



11 DDT™ (Distortion Detection Technique)

This button prevents power amplifier clipping that can sound bad and damage speakers. The "IN" or "DEFEAT" position of the switch bypasses the DDT circuit. However, Peavey® recommends the DDT stay enabled for optimum system performance.

12 HEADPHONE OUTPUT

1/4" headphone output for personal monitoring.

13 DDT INDICATOR LIGHT

When the DDT is enabled, the Protect/Clip LED will flash when DDT is triggered. It is normal operation for the LED to flash. However, if the LED is constantly illuminated, the gain level needs to be adjusted to prevent possible equipment damage. When the DDT is defeated, the LED becomes a clip indicator.

14 POWER SWITCH

To apply power to the unit, flip the switch to the "On" position. The blue LED will illuminate, indicating power is being supplied.

Caution: The on/off switch in this unit does not break both sides of the primary mains. Hazardous energy can be present inside the chassis even when the on/off switch is in the OFF position.

15 AC POWER INLET:

This is the receptacle for an IEC line cord, which provides AC power to the unit. Connect the line cord to this connector to provide power to the unit. Damage to the equipment may result if improper line voltage is used. (See line voltage marking on unit).



Never break off the ground pin on any equipment. It is provided for your safety. If the outlet used does not have a ground pin, a suitable grounding adapter should be used, and the third wire should be grounded properly. To prevent the risk of shock or fire hazard, always make sure that the amplifier and all associated equipment is properly grounded.



NOTE: FOR UK ONLY

As the colors of the wires in the mains lead of this apparatus may not correspond with the colored markings identifying the terminals in your plug, proceed as follows: (1) The wire that is colored green and yellow must be connected to the terminal that is marked by the letter E, or by the Earth symbol, or colored green or green and yellow. (2) The wire that is colored blue must be connected to the terminal that is marked with the letter N, or the color black. (3) The wire that is colored brown must be connected to the terminal that is marked with the letter L, or the color red.



16 EXTERNAL SPEAKER OUTPUT

1/4" powered output for powering a passive enclosure.

17 EFFECTS LOOP

The Send Jack provides a pre amp output that may be used to drive slave amplifiers and external effects processors. The Return Jack provides a power amp input for the last effect in the chain. NOTE: When using the unit as a slave power amplifier, the Return Jack should be used as the input.

18 GROUND LIFT

This button is provided to prevent a ground loop that may result in "hum" noise. When depressed (IN position), Ground Lift is engaged.

19 DIRECT INTERFACE (DI)

This is a built-in, balanced Direct Interface is used to send a buffered, unprocessed signal to an external mixer. NOTE: The Direct Interface features failsafe circuitry, which runs on standard 48-volt phantom power from the mixer. This allows the DI to continue functioning even in the event of a blown circuit breaker or amplifier shutdown. In the event of a failsafe operation, the mute switch will be bypassed. This circuit is active, even when the power switch is in the "Off" position.

Tour™ Series Specifications

Tour Series TNT Combo

Mains Voltage:

120 VAC 60 Hz - F8AL/250V
230 VAC 50/60 Hz - F8AL/250V
100 VAC 50/60 Hz - F8AL/250V

Power Consumption:

600 W

Power Amplifier

Protection:

DDT™ speaker protection with defeat switch
Short Circuit protection
Thermal protection circuit
Cooling fan failure protection circuit
Current limit protection circuit
DC output protection circuit

Minimum Load:

4 Ω

Input Sensitivity:

600 mVRMS

Output Jacks:

Two 1/4" Speakon® combination jacks in parallel

Power Output:

300 w, 48.9 VRMS/8 Ω
450 w, 42.4 VRMS/4 Ω

Noise:

> 100 dB below full power @ 8 Ω
typically -105 dB

Preamplifier Specifications

Settings (unless otherwise stated):

Pre gain: 4 (12 o'clock)
Bright: Out
Mute: out
Contour: 0 (fully counterclockwise)
Low: 0
High: 0
Low Cut: Out
Graphic EQ: All sliders set to center
EQ Bypass: Out
Post Gain: 10 (fully clockwise)
Octaver: MIN
(fully counterclockwise)
Octaver Defeat: Out
DDT™: Active

Input Sensitivity (High Gain):

Nominal Input: 616 mVRMS
Minimum Input: 34.1 mVRMS
Maximum Input: 2.3 VRMS
(maximum signal at input before clipping)

Input Sensitivity (Low Gain):

Nominal Input: 1.0 VRMS
Minimum Input: 59.3 m VRMS
Maximum Input: 7.2 VRMS
(maximum signal at input before clipping)

Tuner Send:

Buffered from input jack with no equalization

D.I. XLR Output:

Buffered from input jack with no equalization

Failsafe D.I. Backup:

48 v phantom power

Weight:

75 lbs.

Dimensions (h x w x d):

22.0" x 23.3" x 19.5"

Features and specifications subject to change without notice.
All specifications tested with mains voltage maintained at nominal level.

Tour™ Series Specifications

Tour Series TKO Combo

Specifications Not Available
At Time Of Press

Features and specifications subject to change without notice.
All specifications tested with mains voltage maintained at nominal level.

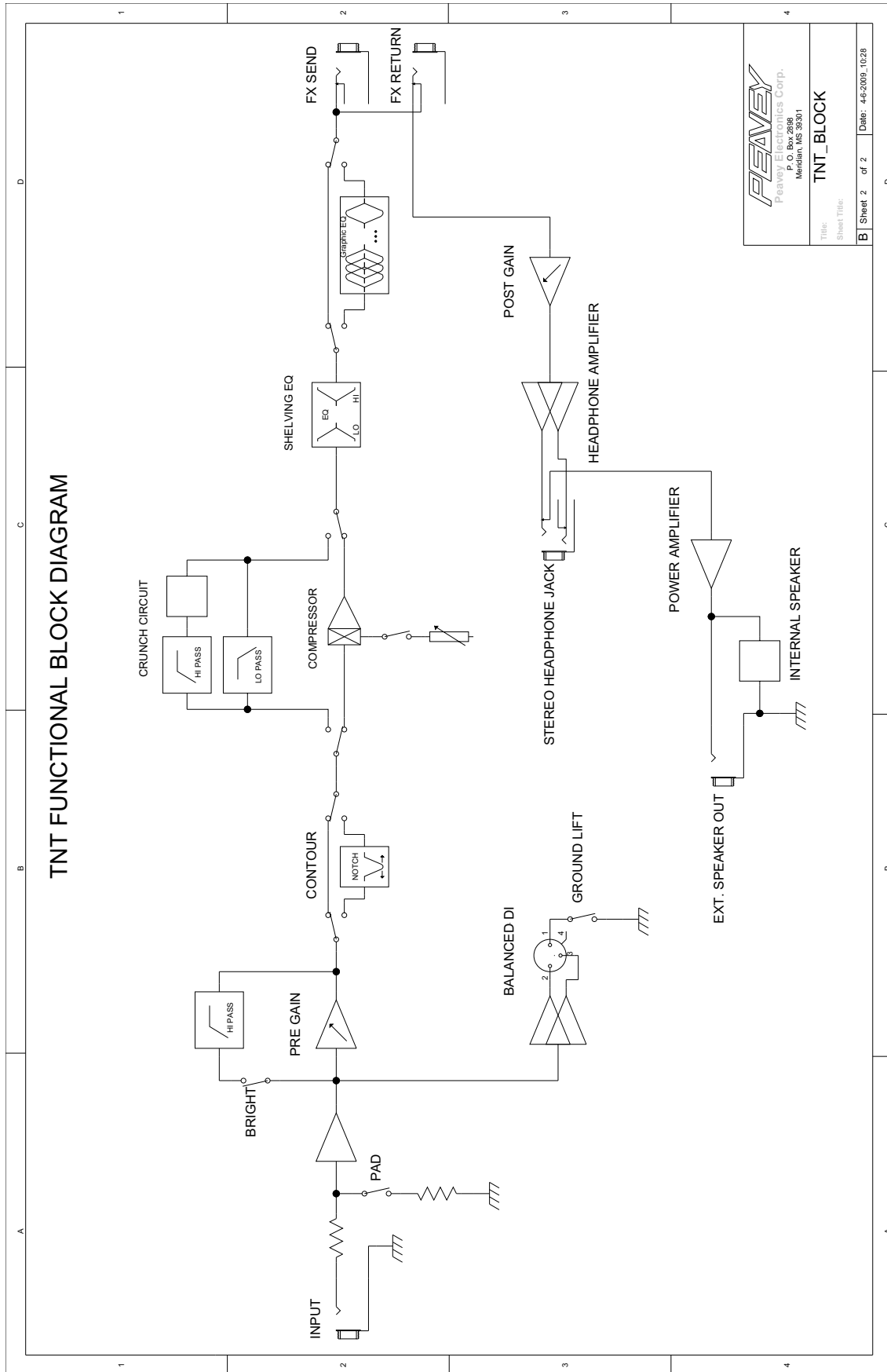

PEAVEY	
Peavey Electronics Corp. P. O. Box 2106 Meriden, MS 39301	
TNT_BLOCK	
Sheet Title:	
B Sheet 2	of 2 Date: 4-6-2009_10:28

TKO FUNCTIONAL BLOCK DIAGRAM

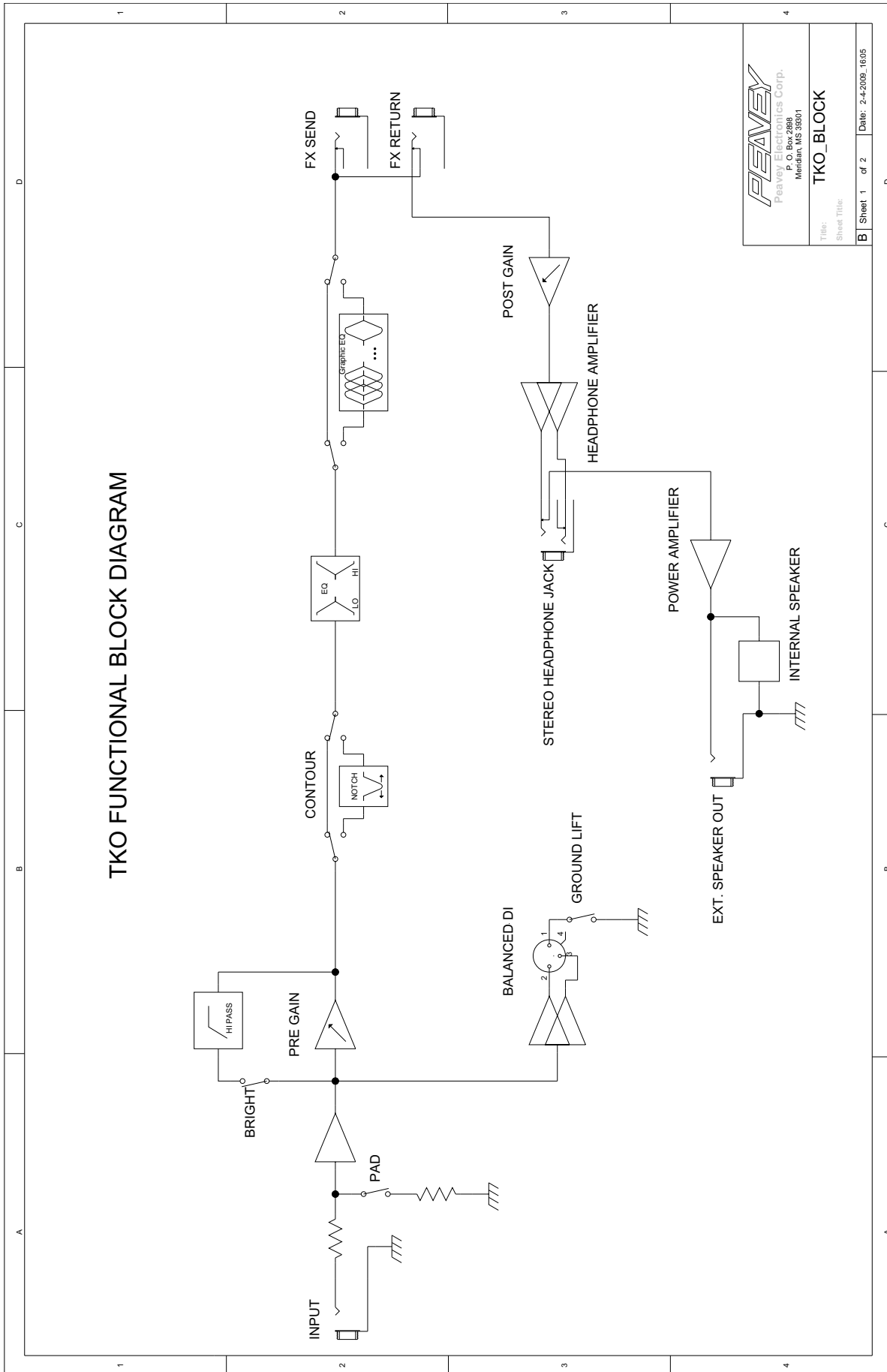

Peavey Electronics Corp.
Meridian, MS 38001

TKO_BLOCK

Title:
Sheet Title:

B Sheet 1 of 2 Date: 2-4-2009_16:05

PEAVEY ELECTRONICS CORPORATION LIMITED WARRANTY

Effective Date: 03/04/2010

What This Warranty Covers

Your Peavey Warranty covers defects in material and workmanship in Peavey products purchased and serviced in the U.S.A. and Canada.

What This Warranty Does Not Cover

The Warranty does not cover: (1) damage caused by accident, misuse, abuse, improper installation or operation, rental, product modification or neglect; (2) damage occurring during shipment; (3) damage caused by repair or service performed by persons not authorized by Peavey; (4) products on which the serial number has been altered, defaced or removed; (5) products not purchased from an Authorized Peavey Dealer.

Who This Warranty Protects

This Warranty protects only the original purchaser of the product.

How Long This Warranty Lasts

The Warranty begins on the date of purchase by the original retail purchaser. The duration of the Warranty is as follows:

Product Category	Duration
Guitars/Basses, Amplifiers, Preamplifiers, Mixers, Electronic Crossovers and Equalizers	2 years *(+ 3 years)
Drums	2 years *(+ 1 year)
Enclosures	3 years *(+ 2 years)
Digital Effect Devices and Keyboards and MIDI Controllers	1 years *(+ 1 year)
Microphones	2 years
Speaker Components (incl. Speakers, Baskets, Drivers, Diaphragm Replacement Kits and Passive Crossovers)	1 year
Tubes and Meters	90 Days
Cables	Limited Lifetime
Rockmaster Series, Strum'n Fun, Vectra, Rotor, OCC Stage pack, GT & BT Series amps, Retro Fire, Metal Maker and Iron Wing	1 year

[* Denotes additional Warranty period applicable if optional Warranty Registration Card is completed and returned to Peavey by original retail purchaser within 90 days of purchase.]

What Peavey Will Do

We will repair or replace (at Peavey's discretion) products covered by Warranty at no charge for labor or materials. If the product or component must be shipped to Peavey for Warranty service, the consumer must pay initial shipping charges. If the repairs are covered by Warranty, Peavey will pay the return shipping charges.

How To Get Warranty Service

(1) Take the defective item and your sales receipt or other proof of date of purchase to your Authorized Peavey Dealer or Authorized Peavey Service Center.

OR

(2) Ship the defective item, prepaid, to Peavey Electronics Corporation, International Service Center, 412 Highway 11 & 80 East, Meridian, MS 39301. Include a detailed description of the problem, together with a copy of your sales receipt or other proof of date of purchase as evidence of Warranty coverage. Also provide a complete return address.

Limitation of Implied Warranties

ANY IMPLIED WARRANTIES, INCLUDING WARRANTIES OF MERCHANTABILITY AND FITNESS FOR A PARTICULAR PURPOSE, ARE LIMITED IN DURATION TO THE LENGTH OF THIS WARRANTY.

Some states do not allow limitations on how long an implied Warranty lasts, so the above limitation may not apply to you.

Exclusions of Damages

PEAVEY'S LIABILITY FOR ANY DEFECTIVE PRODUCT IS LIMITED TO THE REPAIR OR REPLACEMENT OF THE PRODUCT, AT PEAVEY'S OPTION. IF WE ELECT TO REPLACE THE PRODUCT, THE REPLACEMENT MAY BE A RECONDITIONED UNIT. PEAVEY SHALL NOT BE LIABLE FOR DAMAGES BASED ON INCONVENIENCE, LOSS OF USE, LOST PROFITS, LOST SAVINGS, DAMAGE TO ANY OTHER EQUIPMENT OR OTHER ITEMS AT THE SITE OF USE, OR ANY OTHER DAMAGES WHETHER INCIDENTAL, CONSEQUENTIAL OR OTHERWISE, EVEN IF PEAVEY HAS BEEN ADVISED OF THE POSSIBILITY OF SUCH DAMAGES.

Some states do not allow the exclusion or limitation of incidental or consequential damages, so the above limitation may not apply to you.

This Warranty gives you specific legal rights, and you may also have other rights which vary from state to state.

If you have any questions about this Warranty or services received or if you need assistance in locating an Authorized Service Center, please contact the Peavey International Service Center at (601) 483-5365.

Features and specifications are subject to change without notice.



Logo referenced in Directive 2002/96/EC Annex IV (OJ(L)37/38,13.02.03 and defined in EN 50419: 2005
The bar is the symbol for marking of new waste and is applied only to equipment manufactured after 13 August 2005



Features and specifications subject to change without notice.

Peavey Electronics Corporation • 5022 Hartley Peavey Drive • Meridian • MS • 39305
(601) 483-5365 • FAX (601) 486-1278 • www.peavey.com